

BATTLE ARENA 2000WAVE 2

© TAKARA CO., LTD. 1995 / ALL RIGHTS RESERVED.
PROGRAMMED BY © TAMSOFT 1995
CAPCOM CO., LTD. IS AN EXCLUSIVE DISTRIBUTOR

OPERATORS MANUAL



WARNING

This game is for use in the United States of America and Canada. Sales, export or operation outside of these countries may be constructed as copyright and trademark infringements and is strictly prohibited. Violators are subject to severe penalties and will be prosecuted to the full extent of the law.

CAPCOM[®] COIN-OP, INC.
3311 N. Kennicott Avenue
Arlington Heights, Illinois 60004
Phone: (847) 797-6192
Fax: (847) 797-6306

PM00142-KIT
020196

THANK YOU FOR PURCHASING *TOSHINDEN 2 : BATTLE ARENA™*. WE INVITE YOU TO USE THE FOLLOWING MAILING ADDRESS, TELEPHONE OR FAX NUMBER FOR PARTS OR SERVICE INFORMATION CONCERNING THIS GAME:

**CAPCOM® COIN-OP, INC.
ATTN: FIELD SERVICE - VIDEO PRODUCTS
3311 N. KENNICOTT AVENUE
ARLINGTON HEIGHTS, ILLINOIS 60004
PHONE: (847) 797-6192
FAX: (847) 797-6306**

THE SERIAL NUMBERS OF YOUR GAME ARE LOCATED ON THE PRINTED CIRCUIT BOARDS AS SHOWN BELOW. PLEASE HAVE THESE SERIAL NUMBERS AVAILABLE WHEN CONTACTING US FOR SERVICE INFORMATION.

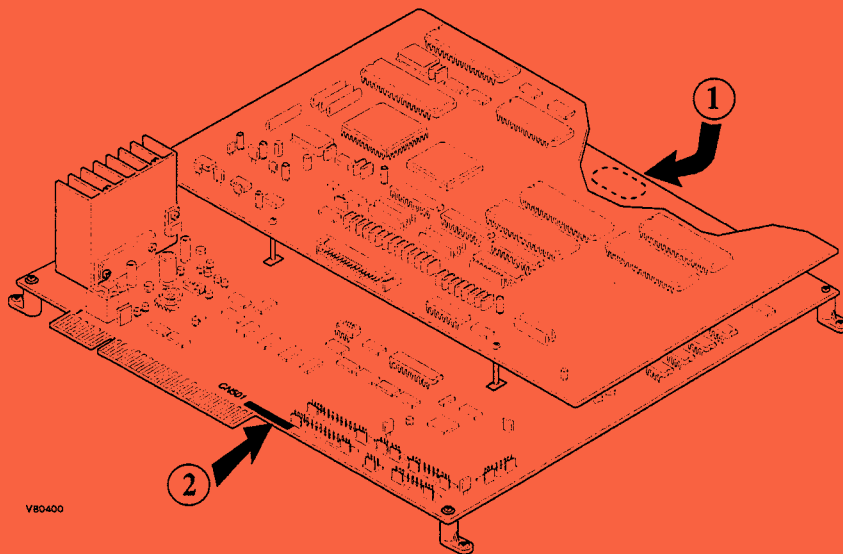

PLEASE RECORD THE PC BOARD SERIAL NUMBERS HERE:

- 1) LOWER PC BOARD - SOLDER SIDE:
AAMA SERIAL NUMBER: _____**

- 2) LOWER PC BOARD - COMPONENT SIDE:
CAPCOM SERIAL NUMBER _____**

TABLE OF CONTENTS

Warranty Information ii

Kit Inspection 1

Kit Installation

 Preparation 3

 Installation 3

 Marquee 3

 Control Panel Components 4

 Cabinet Decals 4

 System Wiring

 Control Panel 5

 Test/Volume Bracket 6

 Speakers 6

 Q-Sound Modification..... 6

 PC Boards 7

Game Adjustments

 Volume Control 7

 Stereo / Monaural 9

 Test Menu 9

 Accessing the Menu 9

 How to Select an Item 9

 Closing the Menu 9

 Menu Item Descriptions 10

 Configuration Menu 11

 System Configuration 12

 Game Configuration 13

Reference Information

 JAMMA Connections 14

 Auxiliary Cable Connections 14

Template : Control Panel Drill Hole(s)

LIMITED PRODUCT WARRANTY (APPLIES TO DOMESTIC SALES ONLY)

CAPCOM® COIN-OP, INC. (Seller), warrants only to the initial purchaser of its products, that the items listed below are free from defects in material and workmanship under normal use and service for the warranty periods specified:

- | | |
|--|--------------|
| A. Printed Circuit Boards : | One (1) Year |
| B. Electronic and Mechanical Components: | (90) days |

No other part of Seller's products are warranted.

Warranty periods are effective from the initial date of shipment from seller to its authorized distributors.

Seller's sole liability shall be, at its option, to repair or replace products which are returned to Seller during the warranty periods specified, provided:

- A. Seller is notified promptly upon discovery by buyer that stated products are defective;
- B. Such products are properly packaged and then returned, prepaid to Seller's designated plant.

This warranty does not apply to any parts damaged during shipment or handling, or due to improper installation or usage, or alteration. In no event shall Seller be liable for any anticipated profits, loss of profits, loss of use, incidental or consequential damages or any other losses incurred by the customer in connection with the purchase of a CAPCOM® COIN-OP, INC. product.

WARRANTY DISCLAIMER

EXCEPT AS SPECIFICALLY PROVIDED IN A WRITTEN CONTRACT BETWEEN SELLER AND PURCHASER, THERE ARE NO OTHER WARRANTIES, EXPRESSED OR IMPLIED, INCLUDING ANY IMPLIED WARRANTIES OF MERCHANTABILITY OR FITNESS FOR A PARTICULAR PURPOSE.

IMPORTANT NOTICE

THIS SHIPMENT HAS BEEN CAREFULLY INSPECTED AND PROPERLY PACKAGED BEFORE LEAVING THE FACTORY. WE CANNOT ASSUME RESPONSIBILITY FOR BREAKAGE THAT MAY OCCUR DURING TRANSPORTATION OF THE GAME. IF THIS GAME IS DAMAGED UPON RECEIPT FROM THE CARRIER, IMMEDIATELY NOTIFY THE CARRIER AND FILE A DAMAGE REPORT.

KIT INSPECTION

Check that all of the following parts have been shipped with your kit. If any parts are missing, contact your distributor immediately.

| PART NO. | DESCRIPTION | QTY |
|-------------|---------------------------------------|-----|
| A-0022200 | PSX System PC Boards | 1 |
| 13-0154 | Standoff w/Screw, PCB Mounting | 4 |
| SC00104-05 | Screw, Wood | 4 |
| GE1200 | Monitor Card | 1 |
| AW00192 | Marquee | 1 |
| 06-0074 | Overlay, Control Panel | 1 |
| AW00193 | Decal, Joystick & Button Switches | 1 |
| AW00147 | Decal, Cabinet Side | 2 |
| AW00196-01 | Decal - Top, Instruction | 1 |
| AW00196-02 | Decal - Bottom , Instruction | 1 |
| PM00142-KIT | Manual, Operators | 1 |
| 03-0104 | Harness, Stereo Speaker | 1 |
| 03-0052 | Cable, Auxiliary | 1 |
| GE2030 | Joystick | 2 |
| 16-0130 | Switch, 1-Player Start Button (White) | 1 |
| 16-0131 | Switch, 2-Player Start Button (White) | 1 |
| 16-0133 | Switch, Button (Red) | 4 |
| 16-0134 | Switch, Button (Blue) | 4 |
| 16-0136 | Switch, Button (Green) | 4 |
| 03-0050 | Bracket, Volume/Test | 1 |

CAUTION

Please read the following instructions to keep the PC boards in good condition:

- ◆ Do not drop or bump the boards.
- ◆ Do not spill any liquids on the boards.

DISASSEMBLING THE BOARDS OR REMOVING STICKERS MAY CAUSE THE TERMINATION OF YOUR REPAIR WARRANTY.

KIT INSTALLATION



WARNING:

MAKE SURE ELECTRICAL POWER TO THE GAME IS OFF BEFORE STARTING THE KIT INSTALLATION.

PREPARATION

1. Disconnect and remove the old printed circuit board(s) or cartridges from the cabinet.
2. Remove or open the control panel, and disconnect and remove the buttons and joystick(s) from the control panel.
3. Remove any covering from the control panel overlay, and then remove the control panel overlay.
4. Place the Drill Hole template over the control panel to determine where any new holes should go. Center punch any needed new holes on the control panel.
5. Cut out the new holes using a 1-3/16" hole saw.
6. If there is an additional control panel *cover (such as plastic or lexan) that will be utilized, cut any additional holes using the same template. *Cover is not included in the kit.
7. Plug up unused holes with a wood dowel (1-1/8" diameter) and sand any rough edges.

INSTALLATION

Marquee Installation

8. Remove the marquee glass, marquee overlay, and the cabinet graphics.
9. Install the new marquee and replace the *glass. *Glass is not included in this kit.

Control Panel Overlay Installation (See Figure 1)

10. The control panel overlay in the kit is oversized to accommodate most control panel sizes. Center

the overlay on the control panel, leaving some excess material at the edges.

11. Remove the protective backing from the overlay and press it down on the control panel, keeping it properly aligned. Press it down firmly, smooth out any bubbles, and press it over the edges.

12. Trim any excess from the overlay. Place the drill hole template on top of the overlay, aligning it with the joystick holes. Pierce through the overlay at each control panel hole. Then, cut away overlay material covering the joystick and button holes. Remove the template and clean off the overlay.

13. Peel off the backings of the 6-button and joystick decals, align over the control panel holes, and press in place on the overlay (refer to the drill hole template for proper placement). Using a knife, trim material from the center hole of the joystick decal.

14. Install the control panel *cover (if required).

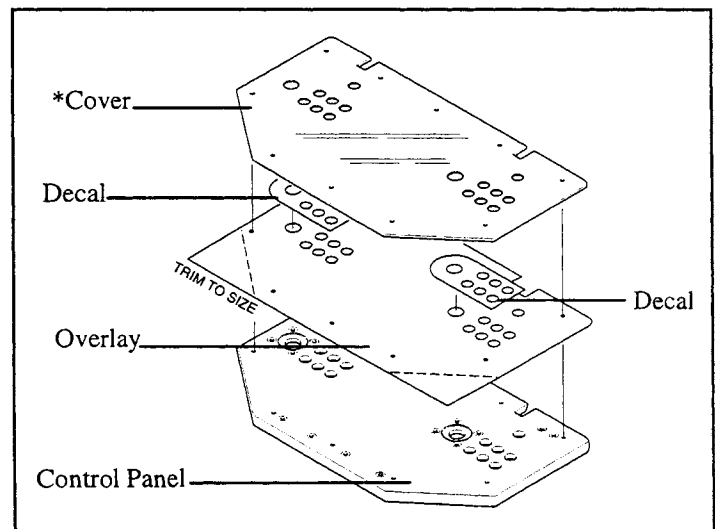

Figure 1
Overlay Installation

Reassembly of Components

15. Install all buttons and retaining rings on the control panel as shown in Figure 2. Install two RED buttons to the immediate right of each joystick, install two GREEN buttons to the right of the red ones, and install two BLUE buttons to the right of the green ones.

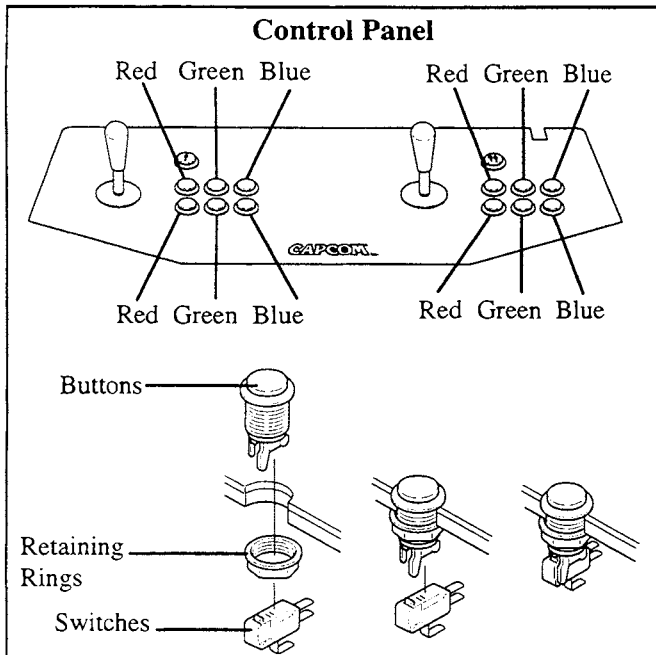

FIGURE 2
Control Panel Buttons and Switches

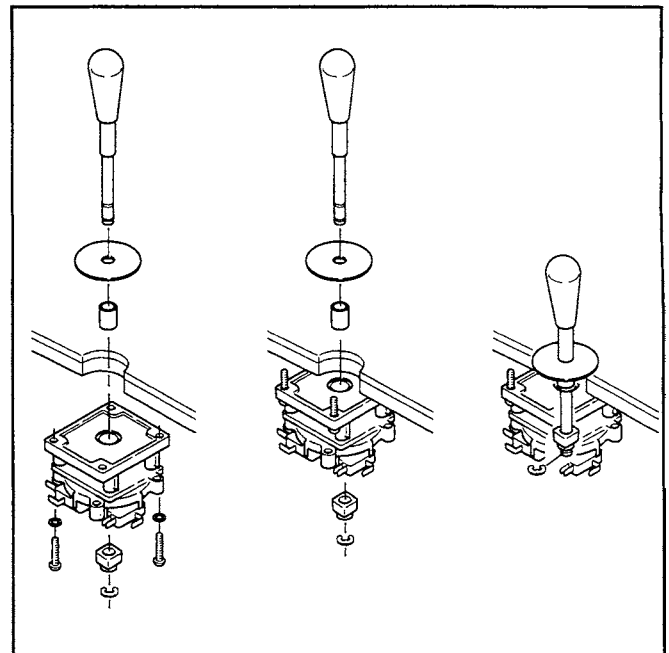

FIGURE 4
Joystick Installation

16. Notice that there are two white buttons. (See Figure 3.) The WHITE buttons are START buttons. Install the PLAYER ONE button on the top left-hand side of the control panel, and the PLAYER TWO button on the top right-side of the control panel.

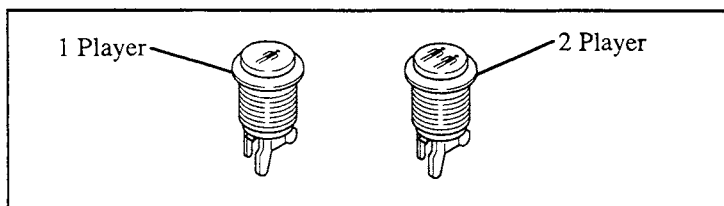

FIGURE 3
Start Buttons

17. Install the switches on the buttons as shown in Figure 2. Orient the switches so that when a button is pressed, the red contact on the switch is depressed.

18. Install the joysticks on the control panel as shown in Figure 4.

CABINET DECAL INSTALLATION

19. Remove monitor glass and install monitor card.

20. Peel-off the backing to the instruction decals and place on both the top and bottom of the monitor card. (See Figure 5). Also, apply the cabinet decals to both sides of the cabinet.

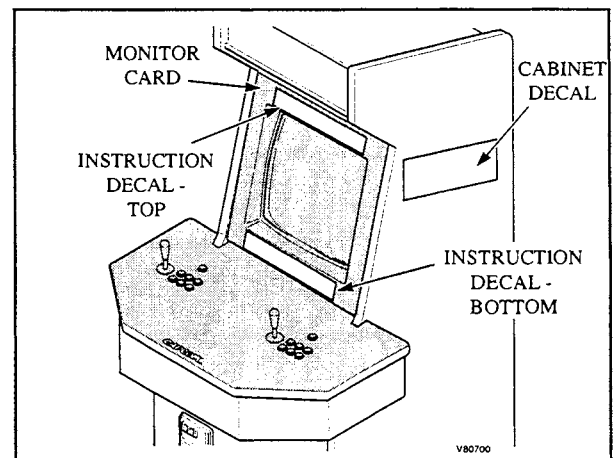

FIGURE 5
Cabinet Decal Installation

SYSTEM WIRING

CONTROL PANEL WIRING

NOTE:

All switch wires used in this game must be wired to the normally-open connection on the switches. Each switch requires a ground wire on the common connector and the appropriate control or switch wire on the normally-open connector of the switch.

21. Reconnect the existing JAMMA connectors to the control panel according to the chart in Figure 5.

22. Connect the Player 1 and the Player 2 ESCAPE and KICK buttons to the auxiliary cable harness connectors as shown in Figure 6. Make the connections according to the chart in Figure 7.

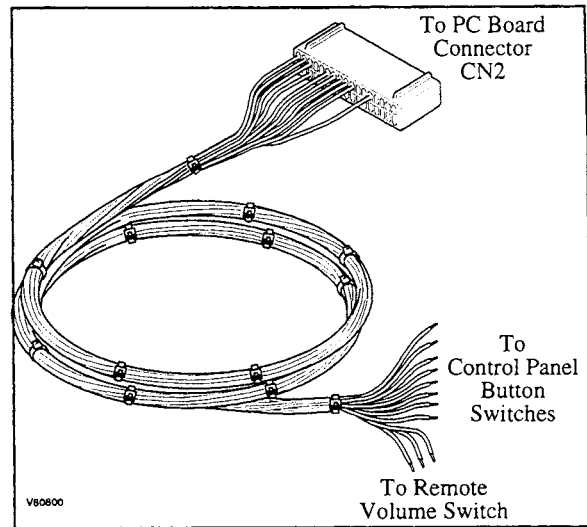

FIGURE 6
Auxiliary Cable Harness

| JAMMA CONNECTOR REF. | *WIRE COLOR | CONNECTS TO | COMPONENT | FUNCTION |
|----------------------|---------------|-------------|---------------|----------|
| 18 | WHITE/BLACK | PLAYER 1 | JOYSTICK | UP |
| 19 | WHITE/BROWN | PLAYER 1 | JOYSTICK | DOWN |
| 20 | WHITE/RED | PLAYER 1 | JOYSTICK | LEFT |
| 21 | WHITE/ORANGE | PLAYER 1 | JOYSTICK | RIGHT |
| 22 | WHITE/YELLOW | PLAYER 1 | ESCAPE BUTTON | IN |
| 23 | WHITE/GREEN | PLAYER 1 | WEAPON BUTTON | LIGHT |
| 24 | WHITE/BLUE | PLAYER 1 | WEAPON BUTTON | HEAVY |
| V | VIOLET/BLACK | PLAYER 2 | JOYSTICK | UP |
| W | VIOLET/BROWN | PLAYER 2 | JOYSTICK | DOWN |
| X | VIOLET/RED | PLAYER 2 | JOYSTICK | LEFT |
| Y | VIOLET/ORANGE | PLAYER 2 | JOYSTICK | RIGHT |
| Z | VIOLET/YELLOW | PLAYER 2 | ESCAPE BUTTON | IN |
| a | VIOLET/GREEN | PLAYER 2 | WEAPON BUTTON | LIGHT |
| b | VIOLET/BLUE | PLAYER 2 | WEAPON BUTTON | HEAVY |

Figure 6: JAMMA Wiring Connections

*** Wire Color Note:** Wire colors shown are according to the AAMA -AMOA Standard for wire color assignments; your harness may contain different colors than shown above.

| AUXILIARY CABLE CONNECTOR REF. | WIRE COLOR | CONNECTS TO | COMPONENT | FUNCTION |
|--------------------------------|---------------|-------------|-----------------------|----------|
| 34 | BLACK | PLAYER 1 | ESCAPE & KICK BUTTONS | COMMON |
| 19 | BLUE | PLAYER 1 | ESCAPE BUTTON | OUT |
| 17 | RED | PLAYER 1 | KICK BUTTON | LIGHT |
| 15 | PINK | PLAYER 1 | KICK BUTTON | HEAVY |
| 33 | BLACK | PLAYER 2 | ESCAPE & KICK BUTTONS | COMMON |
| 21 | GRAY/YELLOW | PLAYER 2 | ESCAPE BUTTON | OUT |
| 23 | PINK/YELLOW | PLAYER 2 | KICK BUTTON | LIGHT |
| 9 | PURPLE/YELLOW | PLAYER 2 | KICK BUTTON | HEAVY |
| 29 | GRAY/YELLOW | | NO CONNECTION | |
| 30 | PINK/YELLOW | | NO CONNECTION | |
| 31 | BLACK/WHITE | | NO CONNECTION | |

Figure 7: Auxiliary Cable Wiring Connections

TEST/VOLUME BRACKET WIRING

23. An optional Test/Volume bracket (see Figure 8) is included in this kit. Your cabinet may already contain this bracket. If you decide to install the bracket, it should be mounted inside the coin door and on top of the cash box for easy access.

NOTE: Only the Test switch is used for this game; the Volume Up/Down switches are disabled.

Volume adjustments must be made through the volume control knob located on the PC board.

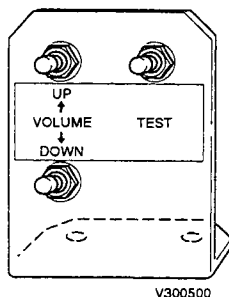

Figure 8: Test Bracket

Wiring of the Test Bracket requires connections to the main JAMMA harness as shown in Figure 9:

| LEAD WIRE COLOR | SWITCH FUNCTION | CONNECTS TO |
|-----------------|-----------------|--|
| YELLOW | VOLUME-UP | NO CONNECTION |
| BLACK | VOLUME-DOWN | NO CONNECTION |
| GREEN | COMMON | NO CONNECTION |
| BROWN | TEST | JAMMA '15' |
| BLACK | GROUND | JAMMA 'A' or 'B' or 'e' or 'f' or '1' or '2' or '27' or '28' |

Figure 9: Test Bracket Wiring Chart

SPEAKER WIRING

28a. If you are converting a cabinet that is not equipped with CAPCOM® Q-SOUND, the leads from the speaker harness (supplied with this kit) must be wired to the cabinet speakers according to the following chart:

| SPEAKER (TERMINAL) | WIRE COLOR |
|--------------------|------------|
| LEFT (+) | WHITE |
| LEFT (-) | GRAY |
| RIGHT (+) | BROWN |
| RIGHT (-) | ORANGE |

28b. If you are converting a cabinet that is equipped with CAPCOM® Q-SOUND, you may elect to wire directly to the cabinet speaker terminals, as shown above, or you can obtain the same result by performing the following modification (see Figure 10):

i) Disconnect the speaker harness connector from the Q-SOUND board at location CB8. **Please note that the Q-SOUND system will be disabled during this game;**

ii) Install a 4-pin, 0.156 inch diameter header connector (not supplied with this kit; purchase locally) onto the speaker harness connector;

iii) Insert each wire lead from the supplied speaker harness to each corresponding pin from a 4-pin, 0.156 inch diameter female connector (not supplied with this kit; purchase locally);

iv) Push the female connector and the header connector pins together.

v) Your cabinet is now equipped to receive stereo sound from the PC board.

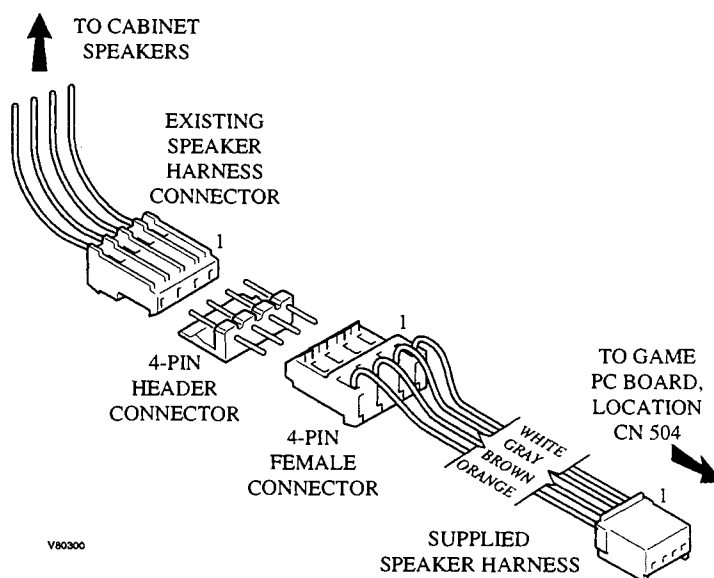

Figure 10: Q-SOUND Modification

29. Install the four (4) mounting standoffs to the underside of the PC board by securing with the supplied machine screws. Then, fasten the PC board standoffs to the control panel shelf with wood screws, as shown in Figure 11.

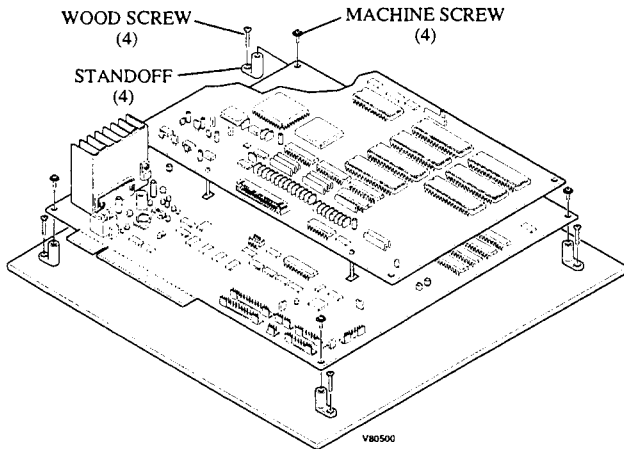

Figure 11: PC Board Mounting

PC BOARD WIRING CONNECTIONS AND ADJUSTMENTS

30. Connect the JAMMA harness connector to the edge connector located on the bottom PC board (see Figure 12).



WARNING

Improper installation of the JAMMA harness connector to the PC board connector will cause damage to the PC board.

31. Attach the auxiliary cable connector to the top PC board at location CN2 (see Figure 12).

32. Attach the speaker harness connector to the PC board at location CN504 (see Figure 12).

33. Check that the mode switch, on the lower PC board, is set to "STEREO" (see Figure 12).

34. Check that all 4 positions of the DIP switch are set to OFF (see Figure 12).

35. Power-up the game and adjust the speaker volume by turning the Volume Control knob clockwise to increase volume, or counterclockwise to decrease volume (see Figure 12).

36. Set all operator adjustable options by pressing the TEST switch. Follow the instructions under the TEST MENU section of this manual.

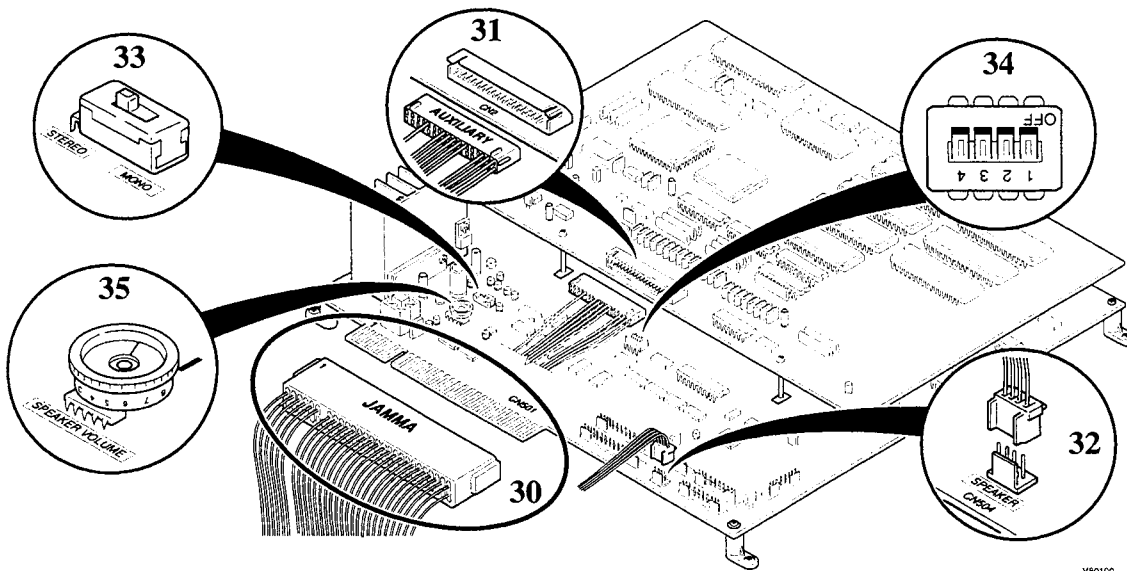

Figure 12: PC Board Wiring Connections & Adjustments

NOTES

TEST MENU

The test menu allows you to test various functions of the game and configure settings used in the game. These items include input devices such as joysticks, buttons and coin mechs, output devices such as monitor, speakers and meters. Through the Test Menu you can also access the Configuration Menu, where you can change the settings of the game.

1. ACCESSING THE TEST MENU

- **For a CAPCOM® cabinet or a converted cabinet with a test switch:**
Make sure the game is on. Open the coin door, find the location of the test switch, and press “Test”. The screen shown below will appear on the monitor:

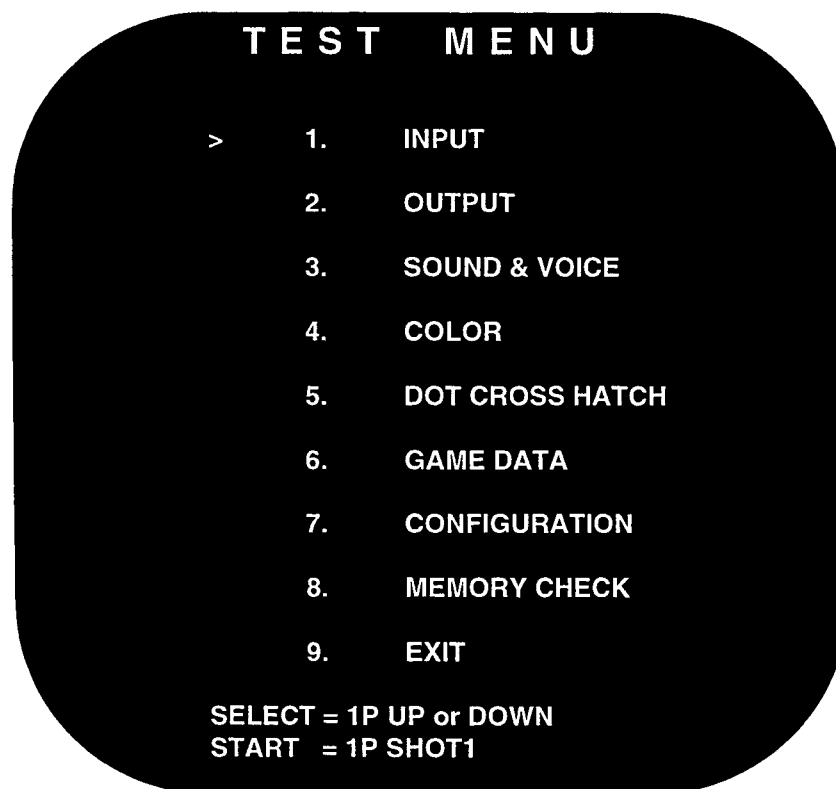

2. HOW TO SELECT AN ITEM

- Use the *PLAYER 1 JOYSTICK* to move the arrow in front of the desired item and press the *PLAYER 1 ESCAPE IN* button.
- To return to the test menu, push the *PLAYER 1 START* and *PLAYER 2 START* buttons simultaneously.
- The test menu will always appear on the screen:
 - a) After you exit the “**7. CONFIGURATION MENU**” and
 - b) After the memory is tested from the menu, “**8. MEMORY CHECK**”.

3. CLOSING THE TEST MENU

To close the Test Menu, highlight “**9. EXIT**” and push the *PLAYER 1 ESCAPE IN* button.

4. TEST MENU ITEM DESCRIPTIONS

| | |
|--------------------------|--|
| INPUT | Used to test all the input switches, such as joysticks and buttons. The “0” changes to a “1” as the button is pushed or joystick is moved. Check connections and switches in case the “0” doesn’t change to a “1” when depressed or moved. |
| OUTPUT | Used to test the coin meter and the coin lock. |
| SOUND & VOICE | Select a code of SOUND or VOICE with the <i>PLAYER 1 JOYSTICK</i> . Push the <i>PLAYER 1 ESCAPE IN</i> button to hear the sound of the selected code. |
| COLOR | Shows color bars of red, green, blue, and white. Adjust RGB and brightness to obtain the optimum color balance and solid black background. |
| DOT CROSS HATCH | Used to test the screen size, focus and distortion. |
| GAME DATA | Coin meter and playtime information will be displayed. |
| CONFIGURATION | Used to change the game play settings. Refer to the CONFIGURATION MENU section. |
| MEMORY CHECK | Used to test memory. “OK” appears when each block of memory passes test, “NG” appears in case of malfunction. If “NG” appears, repeat the memory test and wait for the “OK” message. Contact your distributor if “NG” still appears. |
| EXIT | Select this item and push the <i>PLAYER 1 ESCAPE IN</i> button to return to game play mode. |

CONFIGURATION MENU

The Configuration Menu is used to change various game settings such as level difficulty, credits, sound configuration, etc. These settings are stored in memory on the PCB rather than DIP switches.

The Configuration Menu is divided into 2 sections. In the **SYSTEM** section, you can change credits, sound, and coin door configurations. In the **GAME** section, you can change the play difficulty level and duration of the game.

1. ACCESSING THE CONFIGURATION MENU

- From the TEST MENU, move the arrow to “7. CONFIGURATION” and push the *PLAYER 1 ESCAPE IN* button. The screen below will be displayed. A description of each option is explained in the table below.

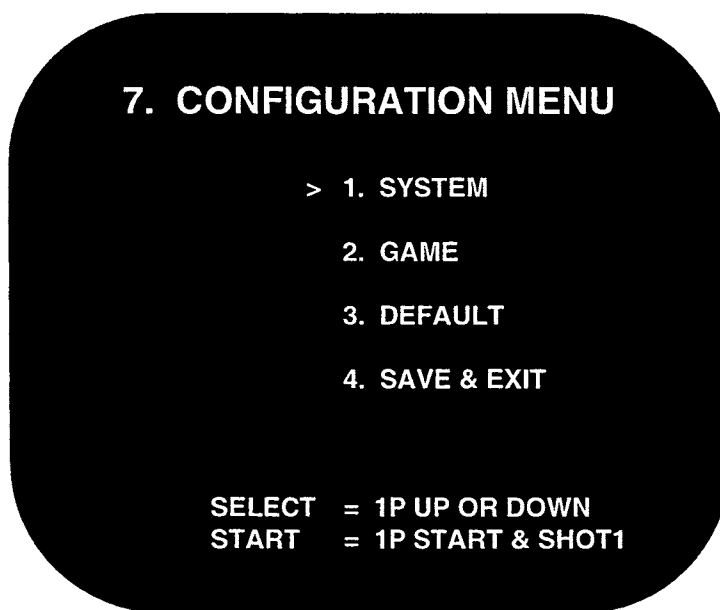

| | |
|------------------------|--|
| SYSTEM | Select this item to change settings for credits, monitor flip, sound and coin door configurations. |
| GAME | Select this item to change difficulty level, damage level, time count speed, maximum number of rounds and event type. |
| DEFAULT | Use this item to restore configuration settings to the original factory values. Press the <i>PLAYER 1 START</i> and <i>PLAYER 1 ESCAPE IN</i> buttons at the same time to select this option. |
| SAVE & EXIT | Use this to save new configuration settings and exit to the Test Menu. The message “SAVING NEW CONFIGURATION IN EEPROM” will appear while the new settings are being saved. DO NOT turn power off to the game until “SAVING” is complete and the Test Menu reappears. |

SYSTEM CONFIGURATION

CHANGING THE SYSTEM CONFIGURATION SETTINGS

Move the *PLAYER 1 JOYSTICK* up or down to highlight the desired option. Once the option is highlighted, move the *PLAYER 1 JOYSTICK* left or right or press the *PLAYER 1 ESCAPE IN* button to select.

7-1. SYSTEM CONFIGURATION

| | |
|----------------|------------------------|
| > 1. COIN MODE | 2 COINS 1COIN CONTINUE |
| 2. CHUTE TYPE | 2 CHUTES SINGLE |
| 3. CONTINUE | ON |
| 4. DEMO SOUND | ON |
| 5. SOUND MODE | MONAURAL |
| 6. EXIT | |

SELECT OPTION = 1P UP OR DOWN
 MODIFY SETTING = 1P LEFT OR RIGHT
 = 1P SHOT1 OR SHOT2

SYSTEM CONFIGURATION ITEM DESCRIPTIONS

| | |
|---------------|--|
| 1. COIN MODE | SELECT THE CHARGE PER PLAY. |
| 2. CHUTE TYPE | SELECT THE NUMBER OF PLAYER(S) AND COIN CHUTES. 1 CHUTE SINGLE: WITH THIS SETTING, EITHER PLAYER CAN START THE GAME. 2 CHUTES SINGLE: TWO PLAYERS USE ONE COIN CHUTE AND PLAY AT THE SAME TIME. THE PLAYER WHOSE COIN WAS PUT IN FIRST STARTS THE GAME. 2 CHUTES MULTI: TWO PLAYERS USE TWO COIN CHUTES AND PLAY SEPARATELY. THE GAME STARTS FROM THE SAME SIDE AS THE COIN CHUTE WAS USED. |
| 3. CONTINUE | USED TO SET THE CONTINUOUS PLAY. |
| 4. DEMO SOUND | TURNS ATTRACT SOUNDS ON OR OFF. |
| 5. SOUND MODE | SELECT STEREO OR MONAURAL FOR USE WITH YOUR CABINET. NOTE: STEREO SHOULD ONLY BE SELECTED WHEN THE CABINET SPEAKERS HAVE BEEN CONNECTED TO THE GAME PC BOARD AT LOCATION CN504. Q-SOUND IS NOT AVAILABLE FOR USE WITH THIS GAME |
| 6. EXIT | TO SAVE THE SETTINGS AND RETURN TO THE CONFIGURATION MENU, HIGHLIGHT THIS ITEM AND PUSH THE <i>PLAYER 1 START</i> BUTTON. |

SYSTEM CONFIGURATION OPTION SETTINGS

| | | | | | |
|---------------|---------------------|---------------------|----------------------------------|---------------------|---------------------|
| 1. COIN | 1 COIN 1 CREDIT | 1 COIN 2 CREDITS | 1 COIN 3 CREDITS | 1 COIN 4 CREDITS | 1 COIN 5 CREDITS |
| | 1 COIN 6 CREDITS | 1 COIN 7 CREDITS | 1 COIN 8 CREDITS | 1 COIN 9 CREDITS | 2 COINS 1 CREDIT |
| | 3 COINS 1 CREDIT | 4 COINS 1 CREDIT | 5 COINS 1 CREDIT | 6 COINS 1 CREDIT | 7 COINS 1 CREDIT |
| | 8 COINS 1 CREDIT | 9 COINS 1 CREDIT | 2 COINS START 1 COIN CONTINUE | FREE PLAY | |
| 2. CHUTE TYPE | 1 CHUTE SINGLE | | | 2 CHUTES SINGLE | |
| 3. CONTINUE | ON | | | OFF | |
| 4. DEMO SOUND | ON | | | OFF | |
| 5. SOUND MODE | STEREO | | | MONAURAL | |

NOTE: FACTORY SETTING

GAME CONFIGURATION

CHANGING THE GAME CONFIGURATION SETTINGS

Move the *PLAYER 1 JOYSTICK* up or down to highlight the desired option. Once the option is highlighted, move the *PLAYER 1 JOYSTICK* left or right or press the *PLAYER 1 ESCAPE IN* button to select.

7-2. GAME CONFIGURATION

- > 1. DIFFICULTY E [...5...] H
- 2. DAMAGE LEVEL L [1.....] H
- 3. TIME COUNT 60
- 4. MAX ROUND 3 ROUNDS
- 5. EXIT

SELECT OPTION = 1P UP OR DOWN
MODIFY SETTINGS = 1P LEFT OR RIGHT
 = 1P SHOT1 OR SHOT2

GAME CONFIGURATION ITEM DESCRIPTIONS

| | |
|-----------------|---|
| 1. DIFFICULTY | SETS THE DIFFICULTY LEVEL. |
| 2. DAMAGE LEVEL | SETS THE OFFENSIVE POWER LEVEL |
| 3. TIMERCOUNT | SETS THE SPEED OF THE COUNTDOWN FROM THE TIMER DISPLAY |
| 4. MAX ROUND | SETS THE NUMBER OF ROUNDS PER MATCH: 1 ROUND: WINNER OF A SINGLE ROUND WINS; 3 ROUNDS: WINNER OF 2 OUT OF 3 ROUNDS WINS; 5 ROUNDS: WINNER OF 3 OUT OF 5 ROUNDS WINS. |
| 5. EXIT | RETURN TO THE CONFIGURATION MENU. |

GAME CONFIGURATION OPTIONS

| | | | | | | | | |
|-----------------|------------|-------------|-------------|---|---|-----------|---|-----------|
| 1. DIFFICULTY | 1 EASY | 2 | 3 | 4 | 5 | 6 | 7 | 8 HARD |
| 2. DAMAGE LEVEL | 1 LOW | 2 | 3 | 4 | 5 | 6 HARD | | |
| 3. TIME COUNT | 30 | 60 | 90 | | | | | |
| 4. MAX ROUND | 1 ROUND | 3 ROUNDS | 5 ROUNDS | | | | | |

NOTE: FACTORY SETTING

JAMMA Connections

| SOLDER SIDE | | COMPONENT SIDE | |
|-------------------------|---|----------------|-------------------------|
| GND | A | 1 | GND |
| GND | B | 2 | GND |
| +5 VDC | C | 3 | +5 VDC |
| +5 VDC | D | 4 | +5 VDC |
| N.C. | E | 5 | N.C. |
| +12 VDC | F | 6 | +12 VDC |
| KEY | H | 7 | KEY |
| N/C | J | 8 | COIN COUNTER 1 |
| COIN LOCK 2 | K | 9 | COIN LOCK 1 |
| *SPEAKER (-) | L | 10 | *SPEAKER (+) |
| N.C. | M | 11 | N.C. |
| VIDEO GREEN | N | 12 | VIDEO RED |
| VIDEO SYNC | P | 13 | VIDEO BLUE |
| SERVICE (FREE CREDIT) | R | 14 | VIDEO GROUND |
| N/C | S | 15 | TEST MODE |
| 2 PLAYER - COIN | T | 16 | 1 PLAYER - COIN |
| 2 PLAYER - START | U | 17 | 1 PLAYER - START |
| 2 PLAYER - UP | V | 18 | 1 PLAYER - UP |
| 2 PLAYER - DOWN | W | 19 | 1 PLAYER - DOWN |
| 2 PLAYER - LEFT | X | 20 | 1 PLAYER - LEFT |
| 2 PLAYER - RIGHT | Y | 21 | 1 PLAYER - RIGHT |
| 2 PLAYER - ESCAPE IN | Z | 22 | 1 PLAYER - ESCAPE IN |
| 2 PLAYER - LIGHT WEAPON | a | 23 | 1 PLAYER - LIGHT WEAPON |
| 2 PLAYER - HEAVY PUNCH | b | 24 | 1 PLAYER - HEAVY PUNCH |
| N/C | c | 25 | N/C |
| N/C | d | 26 | N/C |
| GND | e | 27 | GND |
| GND | f | 28 | GND |

Auxiliary Cable (P/N 03-0052) Connections

| WIRE COLOR | CONNECTOR ODD ROW | | | CONNECTOR EVEN ROW | WIRE COLOR |
|---------------|---------------------|----|----|--------------------|-------------|
| | N/C | 1 | 2 | N/C | |
| | N/C | 3 | 4 | N/C | |
| | N/C | 5 | 6 | N/C | |
| | N/C | 7 | 8 | N/C | |
| PURPLE/YELLOW | PLAYER 2 HEAVY KICK | 9 | 10 | N/C | |
| | N/C | 11 | 12 | N/C | |
| | N/C | 13 | 14 | N/C | |
| PINK | PLAYER 1 HEAVY KICK | 15 | 16 | N/C | |
| RED | PLAYER 1 LIGHT KICK | 17 | 18 | N/C | |
| BLUE | PLAYER 1 ESCAPE OUT | 19 | 20 | N/C | |
| GRAY/YELLOW | PLAYER 2 ESCAPE OUT | 21 | 22 | N/C | |
| PINK/YELLOW | PLAYER 2 LIGHT KICK | 23 | 24 | N/C | |
| | N/C | 25 | 26 | N/C | |
| | N/C | 27 | 28 | N/C | |
| GRAY/YELLOW | N/C | 29 | 30 | N/C | PINK/YELLOW |
| BLACK/WHITE | N/C | 31 | 32 | N/C | |
| BLACK | PLAYER 2 COMMON | 33 | 34 | PLAYER 1 COMMON | BLACK |

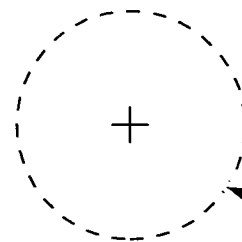

1-3/16" DRILL FOR
PLAYER HOLE

1-3/4" DRILL FOR
JOYSTICK HOLE

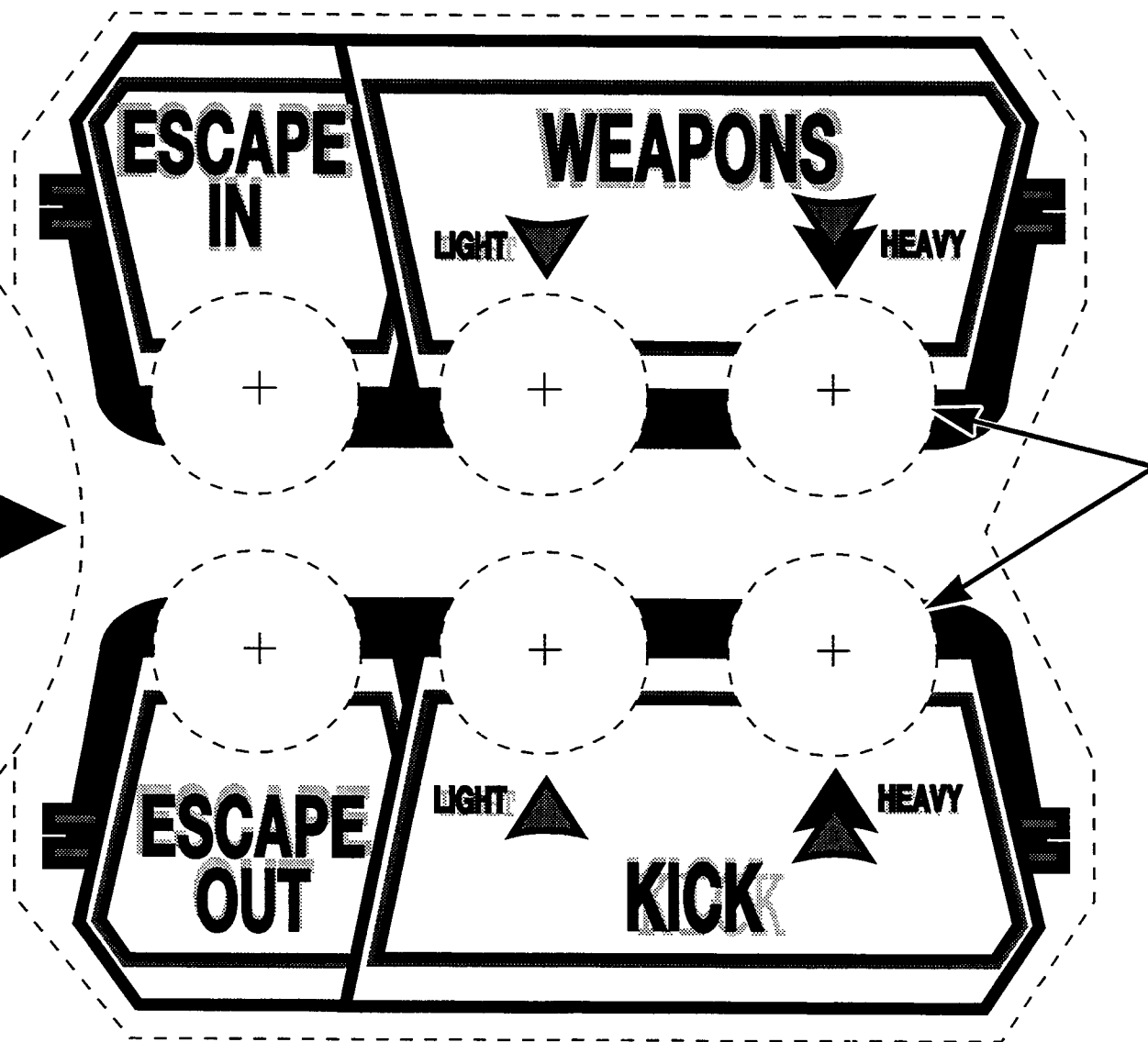
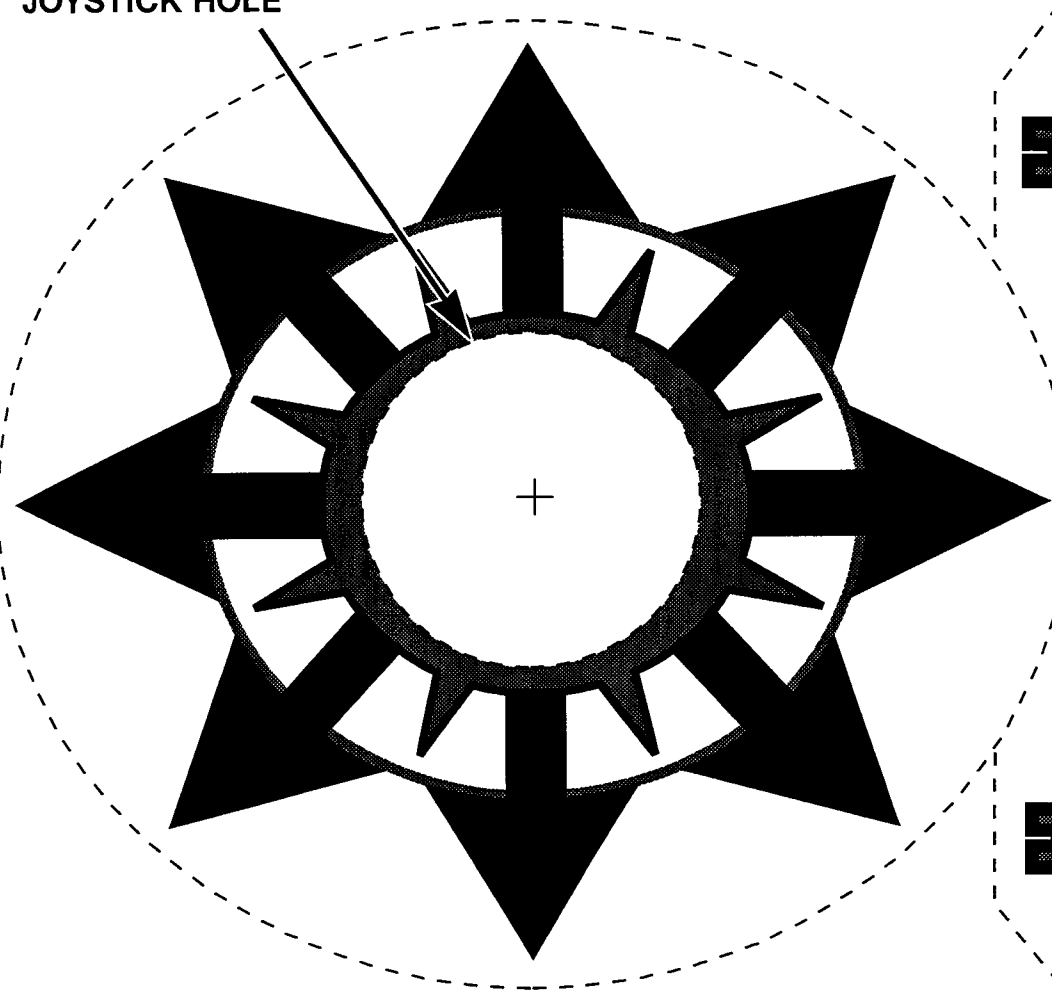

1-3/16" DRILL FOR
BUTTON HOLES

CAPCOM

CAPCOM COIN-OP, INC.
3311 NORTH KENNICOTT AVENUE
ARLINGTON HEIGHTS, ILLINOIS 60004
PHONE (708) 797-6100
FAX (708) 797-6119

TITLE

"TOSHINDEN 2" DRILL TEMPLATE

DATE

1-22-96

DRAWN BY:

JA

V80200

REV.

REFERENCE INFORMATION

PC BOARD CONNECTIONS AND CONTROLS

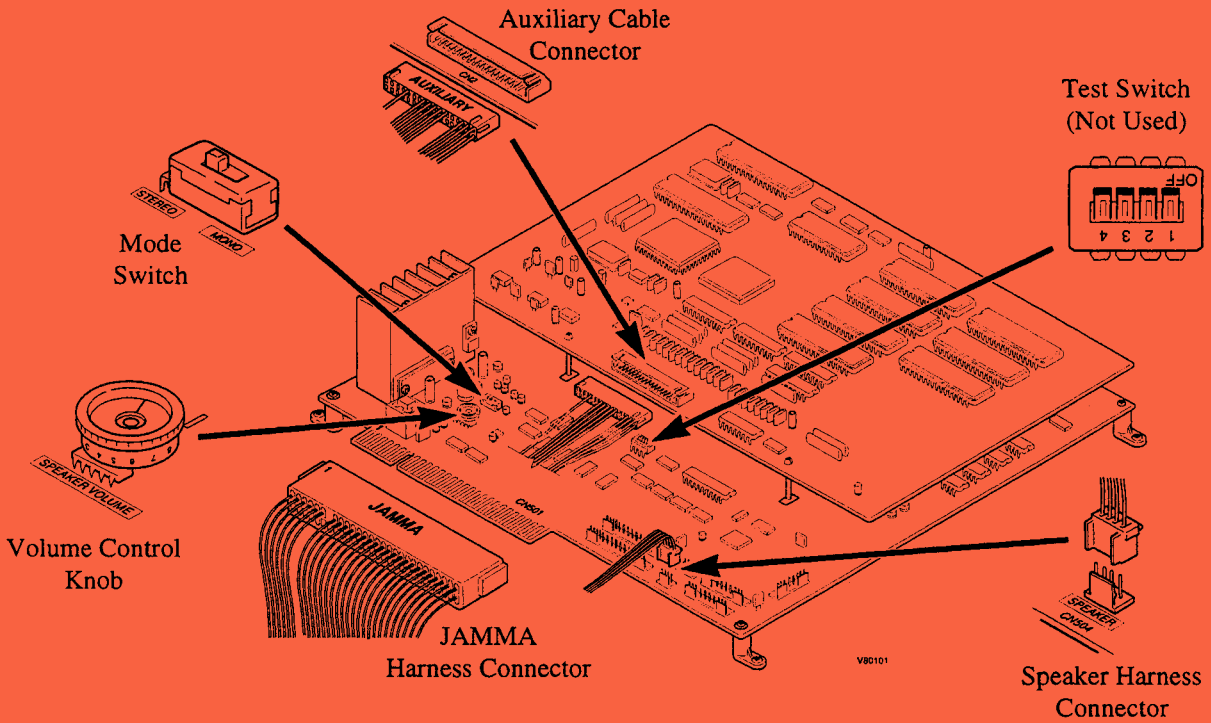

TYPICAL CONTROL PANEL LAYOUT OF BATTLE ARENA TOSHINDEN 2™

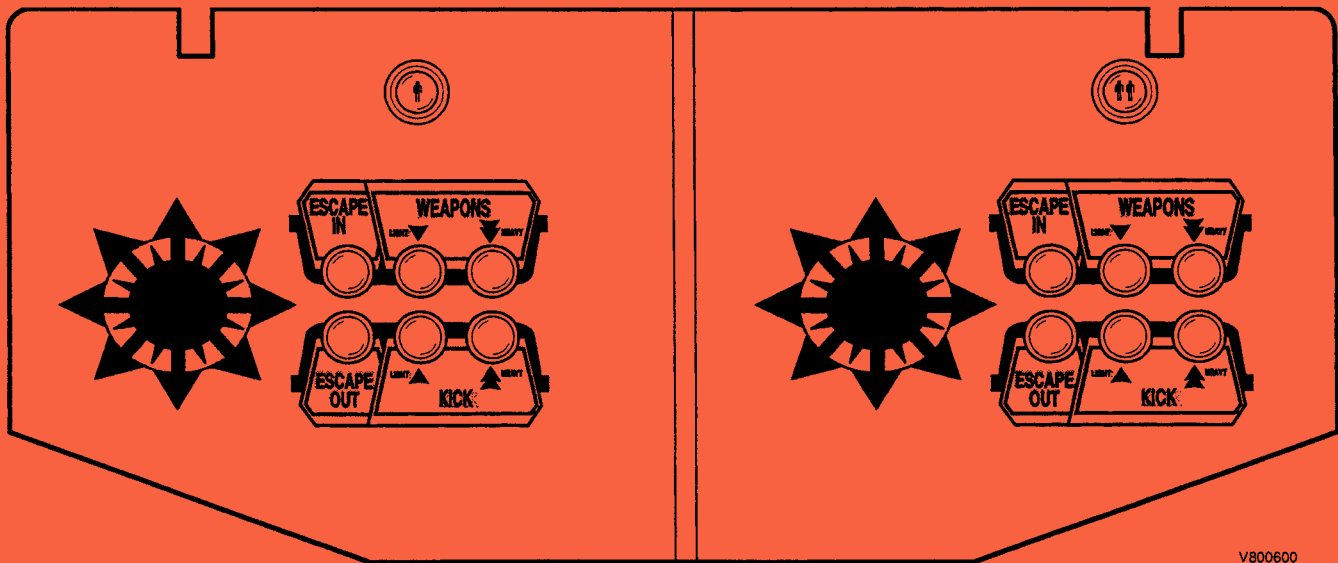

NOTICE

This equipment has been tested and found to comply with the limits for a Class A digital device, pursuant to Part 15 of the FCC Rules. These limits are designed to provide reasonable protection against harmful interference when the equipment is operated in a commercial environment. This equipment generates, uses, and can radiate radio frequency energy and, if not installed and used in accordance with the instruction manual, may cause harmful interference to radio communications. Operation of this equipment in a residential area is likely to cause harmful interference, in which case the user will be required to correct the interference at his own expense.



WARNING

Federal law provides severe civil and criminal penalties for the unauthorized reproduction, distribution, or exhibition of copyrighted audiovisual works and video games.

The Federal Bureau of Investigation investigates allegations of criminal copyright infringement.

CAPCOM[®] COIN-OP, INC.
3311 N. Kennicott Avenue
Arlington Heights, Illinois 60004
Phone: (847) 797-6192
Fax: (847) 797-6306