

SEGA[®]

CRACKDOWN

**2 PLAYER TYPE
OWNER'S MANUAL**



SEGA ENTERPRISES, LTD.

TABLE OF CONTENTS

Introduction to the Owner's Manual	1
1. Handling Precautions	2
2. Prevention of Counterfeiting and Conversion	2
3. Precautions Concerning the Place of Installation	3
4. Disk Installation	4
5. Name of Parts	5
6. Adjustment of the Service Switch	6
7. Servicing the Power Supply Unit and Fuse	7
8. P.C. Board Assembly	7
9. Servicing the Floppy Disk	8
10. Crackdown Test Mode	9
11. Drawing of P.C. Assembly	15
12. P.C. Board Component Locations	16
13. Monitor Adjustments and Game Board Servicing	17
14. Parts List	18
15. Adjustment Instruction Switch Setting Sheet	20
16. Schematic Diagram	Inside Back Cover

SPECIFICATIONS

INSTALLATION SPACE :	30 in. W x 37 in. D
HEIGHT :	73 in.
POWER :	201 W
C.R.T. :	26 MONITOR MED. RESOLUTION
WEIGHT :	140 kg (307 lbs.)

NOTE

- Descriptions herein contained may be subject to improvement changes without notice.

INTRODUCTION TO THE OWNER'S MANUAL

SEGA ENTERPRISES, LTD., supported by its high electronic technology of LSIs, microprocessors, etc., and a wealth of experience, has for more than 30 years been supplying various innovative and popular game machines to the world market. This OWNER'S manual is intended to provide detailed comments together with all the necessary information covering the operation in general of electronic assemblies, electromechanicals, servicing control, spare parts, etc. as regards the CRACKDOWN, a new SEGA product. The manual is intended for those who have knowledge of electricity and technical expertise especially in ICs, CRTs, microprocessors, etc. Carefully read so as to acquire sufficient knowledge before working on the machine. Should there be a malfunction, non-technical personnel should under no circumstances touch the interior system.

1. HANDLING PRECAUTIONS

When installing or inspecting, be very careful of the following points and pay attention to ensure that the player can enjoy the game safely.

- Be sure to turn the power off before working on the machine.
- To insert or pull out the plug quickly is dangerous.
- It is necessary to make sure that the power cord or the grounding wire is not exposed on the road, etc. in a manner so as to be dangerous. Make sure that grounding connections are made safely at the position where so specified.
- Do not use any fuse that does not meet the specified rating.
- Make complete connections for the IC board and other connectors. Insufficient insertion is very dangerous.
- For protection of the disk, please remove from machine prior to relocation.

Also, for the IC board circuit inspections, only the logic tone is allowed. The use of a tester is not permitted, so be careful in this regard. After confirming that there are no irregularities, turn the power ON.

2. PREVENTION OF COUNTERFEITING AND CONVERSION

LABELLING

To prevent counterfeits and conversions, the following labels are put on all the SEGA products. When handling such goods, be sure to confirm the labels. They are used to prevent illegal acts such as the unauthorized copying of the products and the printed circuit boards thereof or carrying on business by manufacturing similar merchandise or by converting, selling or using such products or printed circuit boards.

ORIGINAL SEAL

The following seal is put on the machines manufactured by SEGA.



LICENSE SEAL

The following seal is put on the kits, such as the printed circuit boards, of SEGA products.



COPYRIGHT NOTICE

This SEGA product has the copyright notice as follows:

© SEGA 1989

This signifies that this work was disclosed in 1989 and is the property of SEGA ENTERPRISES, LTD

3. PRECAUTIONS CONCERNING THE PLACE OF INSTALLATION

The CRACKDOWN is an indoor game machine. Absolutely do not install it outside. Even indoors, avoid installing in places mentioned below so as to ensure proper usage:

- Places subject to rain or water leakage, or condensation due to humidity.
- In the proximity of an indoor swimming pool and/or shower.
- Places subject to direct sunlight.
- Places subject to heat sources from heating units, etc., or hot air.
- Vicinity of highly inflammable/volatile chemicals or hazardous matter.
- Sloped surfaces.
- Vicinity of anti-disaster facilities such as fire exits and fire extinguishers.
- Places subject to any type of violent impact.
- Dusty places.

4. DISK INSTALLATION

IMPORTANT

INSTALLATION INSTRUCTIONS

CRACKDOWN contains a revolutionary new memory system for video games. This memory system is a Floppy Disk System which is housed in the RF Cage. This system allows Sega to give you more memory at a cost effective price.

To insure that no damage occurs to this delicate system during transit, we have packaged the Floppy Disk separately which must be installed upon receipt of the game. Please follow the listed instruction for the installation of the disk.

DISK INSTALLATION

1. Open Coin Door and remove Cash Box.
2. Open Cash Box and remove Floppy Disk. (NOTE: It is housed in a plastic protection cover.)
3. Reach thru the Coin Door opening and unlatch the two spring latches which hold the front assembly securely to the rear assembly of the game. These latches are located on the right, inside of the front assembly.
4. Once the two latches are unlocked, pull on the control panel assembly out for access to PCB RF cage.
5. Remove the cover of the PCB RF Cage by removing the four sheet metal screws.
6. Remove the two screws located on the left side of the wooden base of the PCB Assembly.
7. Lift the right side of the PCB Assembly. This will allow access to the disk drive, which is located underneath the PCB.
8. Remove the disk from the plastic protection case and install it into the disk drive label side up with the metal cover protection slide installed first. The disk should slide in and snap down to indicate that it is securely inserted. Then install cover on FDD unit and secure with two phillips screws provided.
9. Replace the two screws that you removed in Step #6 to secure the Wooden PCB base to the RF Cage.
10. Replace the lid of the RF Cage using the four sheet metal screws that were removed from the assembly in Step #5.
11. Close the control panel and latch.
12. Apply power to the game and verify proper operation. This completes the Drive Assembly.
13. For protection of the disk, please remove it from the machine prior to relocation.

5. NAME OF PARTS (Dynamo HS5 Cabinet Assy)

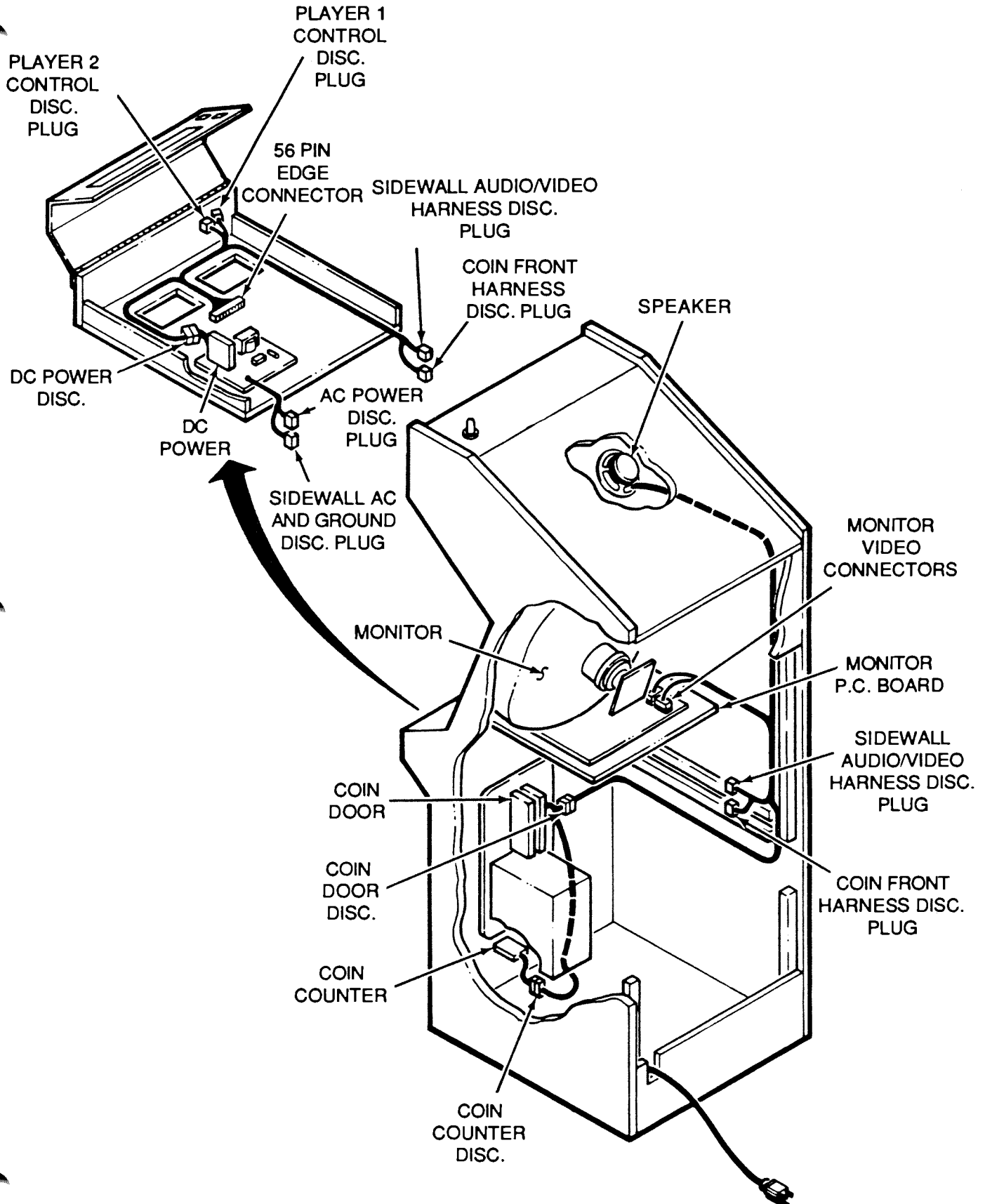

6. ADJUSTMENT OF THE SERVICE SWITCH

The layout as shown below can be viewed by opening the coin chute door.

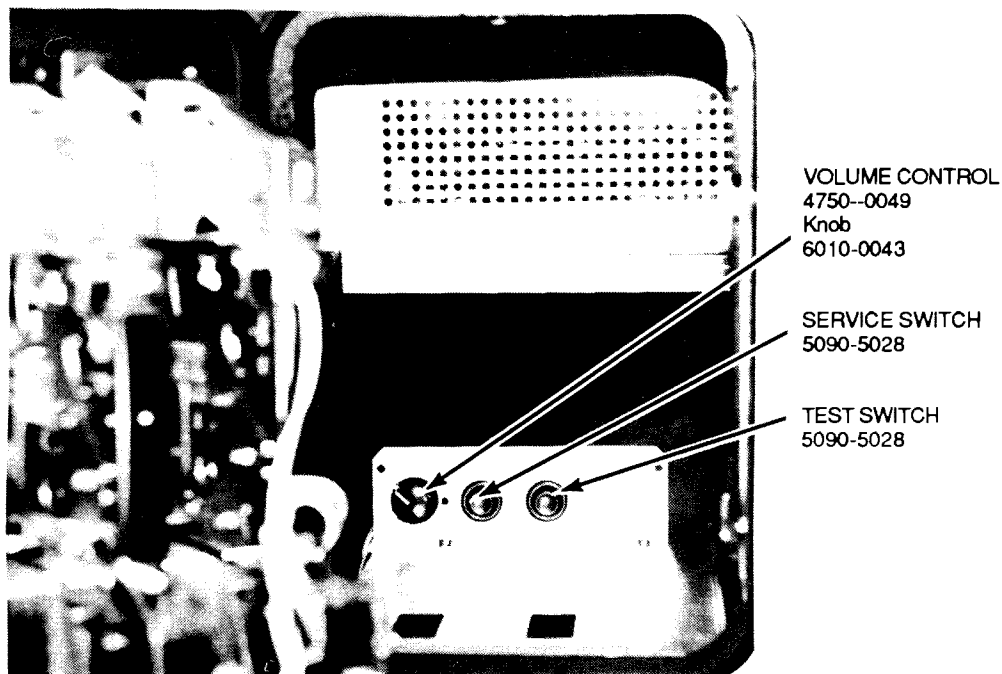

OPERATING INSTRUCTIONS

- SERVICE SWITCH Used for the purpose of servicing and increasing the credits without registering on the meter (this allows you to check the game).
- TEST SWITCH For operating this switch, see SELF-TESTING.
- VOLUME CONTROL Potentiometer Adjustment

7. SERVICING THE POWER SUPPLY UNIT AND FUSE

Power Supply Assembly

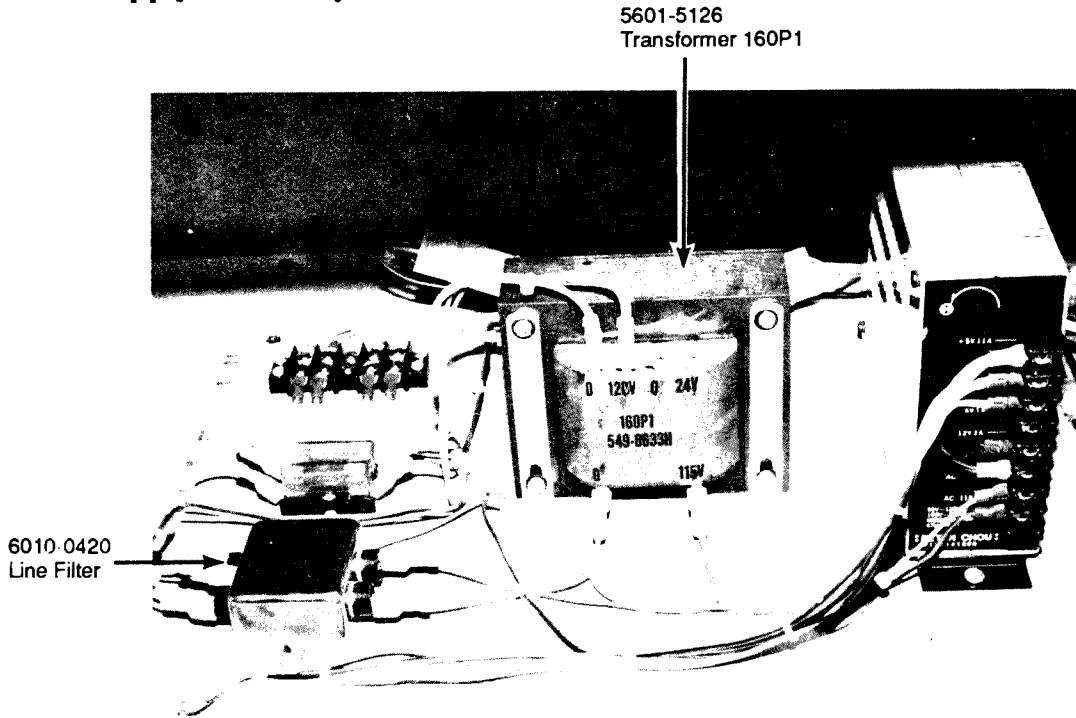

8. P.C. BOARD ASSEMBLY

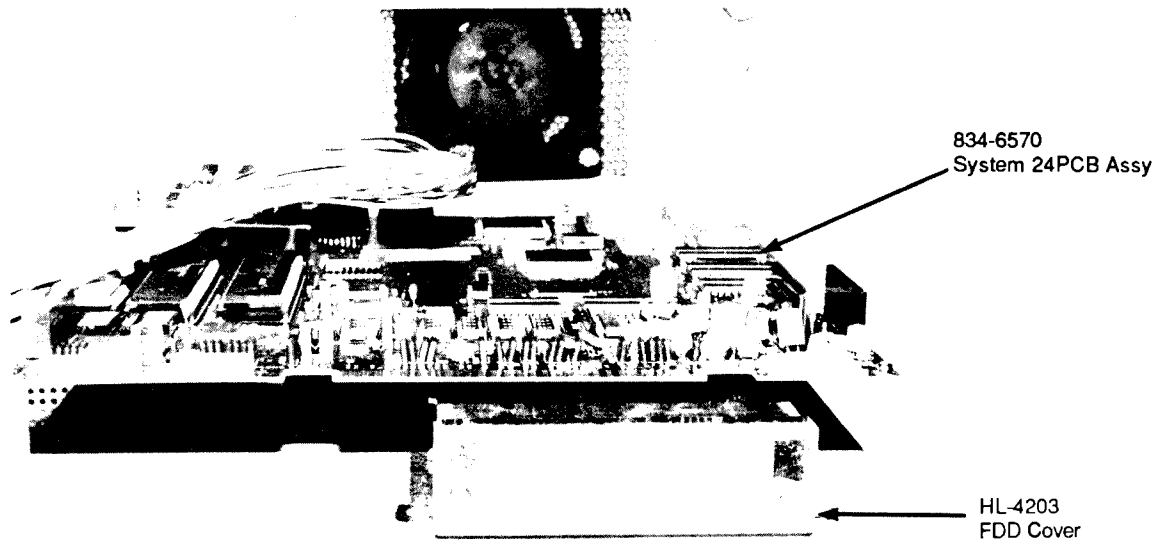

9. SERVICING THE FLOPPY DISK

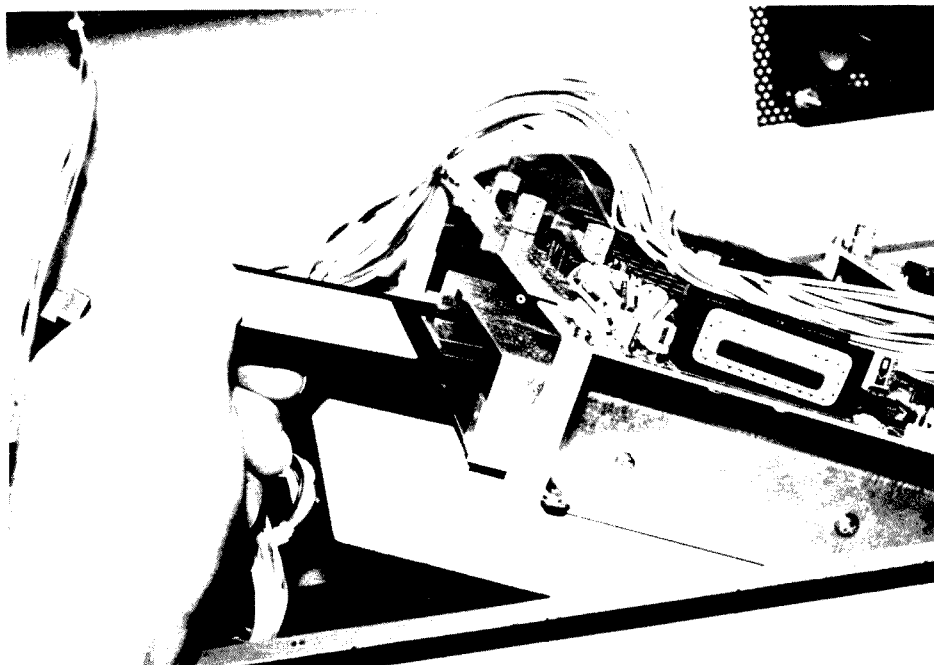

REMOVE THE LID of the SHIELD CASE. Remove the sheet metal and pull out the game board unit in a manner so that both ends of it will meet the shield case. Open the FDD (Floppy Disk Drive) LID by taking off the 2 (M3 x 8) SCREWS when replacing the FLOPPY DISK.

10. CRACK DOWN TEST MODE

To get into test mode, push test switch.

MAIN MENU

→ * RESTART
* INPUT TEST
* BOOKKEEPING
* GAME ADJUSTMENT
* PRICING CONTROL
* TEST PATTERN
* DISK READ TEST
Select by SERVICE and push TEST.

Arrow steps down with pushing service switch to execute test, put arrow at item then push test switch.

* Restart:

Load the game program with warning message. Takes approx. 1 min.

INPUT TEST-a

DIP SW. #2-7 OFF (COMMON COIN SWITCH)

	PLAYER 1	PLAYER 2
Up	OFF	OFF
Down	OFF	OFF
Left	OFF	OFF
Right	OFF	OFF
Attack	OFF	OFF
S. Bomb	OFF	OFF
Start	OFF	OFF
Coin #1	OFF	
Coin #2	OFF	
Service	OFF	

To display next page, Push TEST.

INPUT TEST-b

DIP SW. #2-7 OFF (COIN CHUTES ARE SEPARATED LEFT & RIGHT PLAYERS)

	PLAYER 1	PLAYER 2
Up	OFF	OFF
Down	OFF	OFF
Left	OFF	OFF
Right	OFF	OFF
Attack	OFF	OFF
S. Bomb	OFF	OFF
Start	OFF	OFF
Coin	OFF	OFF
Service	OFF	OFF
All Service	OFF	

To display next page, Push TEST.

Depends on position of the DIP SW #2-7, screen a or b will be displayed

BOOKKEEPING ①

Coin Chute #1	0
#2	0
Service Credits	0
Total Credits	0
Number of Games	0
To display next page, Push TEST.	

- * Maximum credit registration is "9". If credits are more than 9, game does not accept as 'credit' but will add to number of coin.

BOOKKEEPING ②

Total Game Time	00H	00M	00S
Longest	00H	00M	00S
Shortest	00H	00M	00S
Average	00H	00M	00S
1 Player	00H	00M	00S
2 Players	00H	00M	00S
Total Operation Time	00H	00M	00S
Highest Score			Pts.
Lowest Score			Pts.
Average Score			Pts.
To display next page, Push TEST.			

- * Total game time = (2P time) x 2 + (1P time)
- * Average = total game time + number of games

BOOKKEEPING ③

	Continue Games
0	0
1	0
2	0
3	0
4	0
5	0
6	0
7	0
8	0
9	0
10	0
11	0
12	0
13	0
14	0
15 - OVER	0
To display next page, Push TEST.	

BOOKKEEPING ④

Game Times	
0 - 1 MIN.	0
1 - 2 MIN.	0
2 - 3 MIN.	0
3 - 4 MIN.	0
4 - 5 MIN.	0
5 - 6 MIN.	0
6 - 7 MIN.	0
7 - 8 MIN.	0
8 - 9 MIN.	0
9 - 10 MIN.	0
10 - 11 MIN.	0
11 - 12 MIN.	0
12 - 13 MIN.	0
13 - 14 MIN.	0
14 - 15 MIN.	0
15 - OVER	0

To display next page, Push TEST.
To clear data, Push SERVICE.

- * If service SW is pushed to clear data, data ① to ④ will be cleared.
- * Top Score display 1st to 3rd are cleared with this function but rank under 4th are cleared always when power is off.

GAME ADJUSTMENT ①

No Use	[OFF / ON]	(DIP SW. 2-1)
No Use	[OFF / ON]	(DIP SW. 2-2)
No Use	[OFF / ON]	(DIP SW. 2-3)
No Use	[OFF / ON]	(DIP SW. 2-4)
No Use	[OFF / ON]	(DIP SW. 2-5)
No Use	[OFF / ON]	(DIP SW. 2-6)
Coin Chute	[Common/Separate]	(DIP SW. 2-7)
Screen	[Normal/Flip]	(DIP SW. 2-8)

To display next page, Push TEST.

GAME ADJUSTMENT ②

Install Standard	NO
Continue Game	YES
Advertise Sound	NO
Destroy Each Other	YES
Initial Players	3
Initial M. Guns	10
Initial Cannons	NO
Initial S. Bombs	1
Initial GAME DIFFICULTY	5 ✓
	EASY ██████████ HARD
Advance rate of DIFFICULTY	2 min. for 1 level up.
Time Limit	2 MIN. 30 SEC.
Player Extend Score	50000
Eliminate ranking every (plays)	2000

To change values, push 1P ATTACK or S. Bomb.
Select by SERVICE.
To display next page, Push TEST.

- * Highlight bar shows current setting
- * Green displays are default settings
- * Push service switch to select items
- * Push test switch to save data
- * Destroy each other.
Yes: players can fight each other
- * Initial players: selectable 1 to 9
- * Initial M. Guns/Initial Cannons selectable 0 to 9 (10 step)
- * Initial S. Bombs: select 0 to 4
- * Initial game difficulty: select 1 to 8 (1 easiest, 8 hardest)
- * Advance rate of difficulty: progressive difficulty each 1, 2, 3, 5, 7, 10 min, or no.

- * Time limit: select 2m 10s, 2m 20s, 2m 30s, 2m 40s, 2m 50s, or 3m.
- * Player extend score: bonus player score
- * Eliminate ranking player: number of games to clear player ranking.

PRICING CONTROL-a
DIP SW. #2-7 OFF

Coin SW. #1	Coin SW. #2
DIP 1-1 OFF DIP 1-2 OFF DIP 1-3 OFF DIP 1-4 OFF	DIP 1-5 OFF DIP 1-6 OFF DIP 1-7 OFF DIP 1-8 OFF
1 COIN 1 CREDIT	1 COIN 1 CREDIT

To display next page, Push TEST.

PRICING CONTROL-b
DIP SW. #2-7 ON

Coin SW.	—
DIP 1-1 OFF DIP 1-2 OFF DIP 1-3 OFF DIP 1-4 OFF	DIP 1-5 OFF DIP 1-6 OFF DIP 1-7 OFF DIP 1-8 OFF
1 COIN 1 CREDIT	—

To display next page, Push TEST.

TEST PATTERN ①

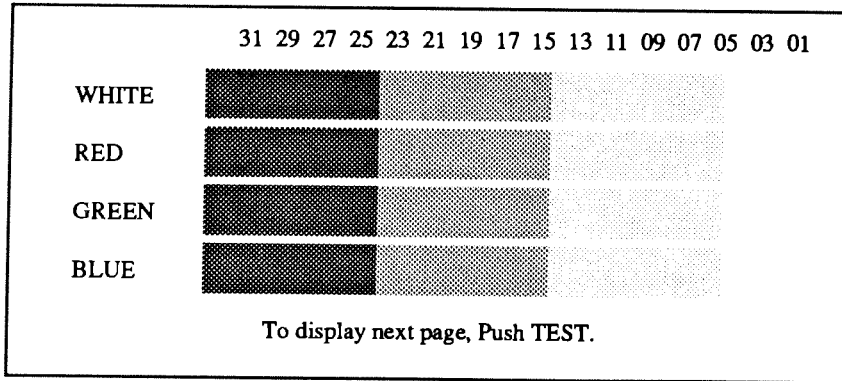

TEST PATTERN ②

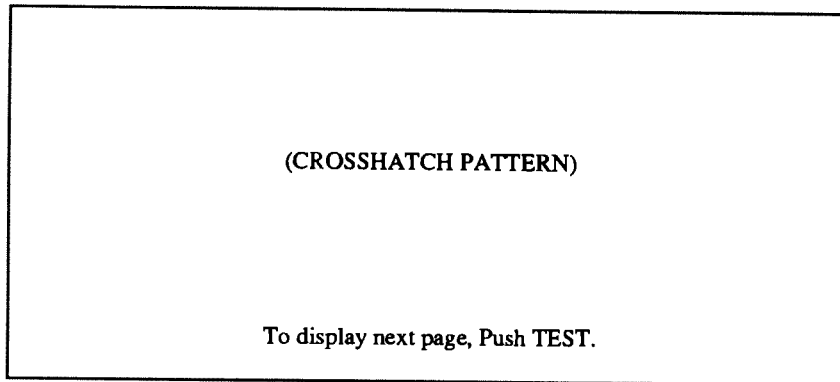

DISK READ TEST ①

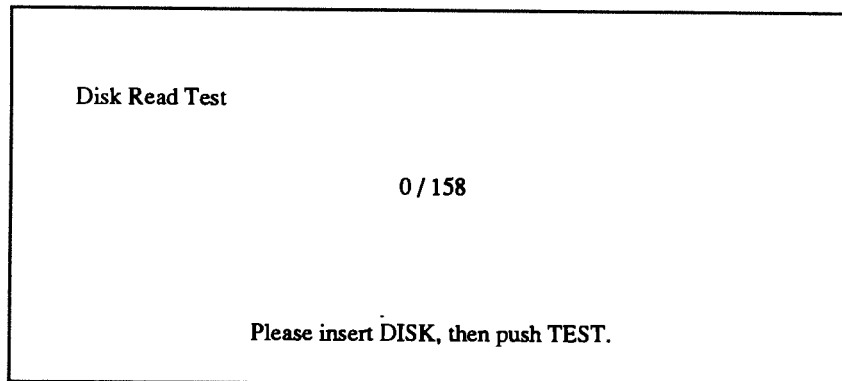

DISK READ TEST ②

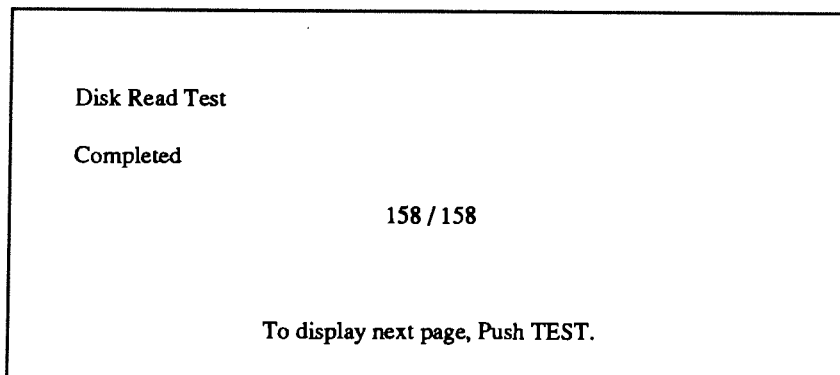

MARQUEE LIGHTING

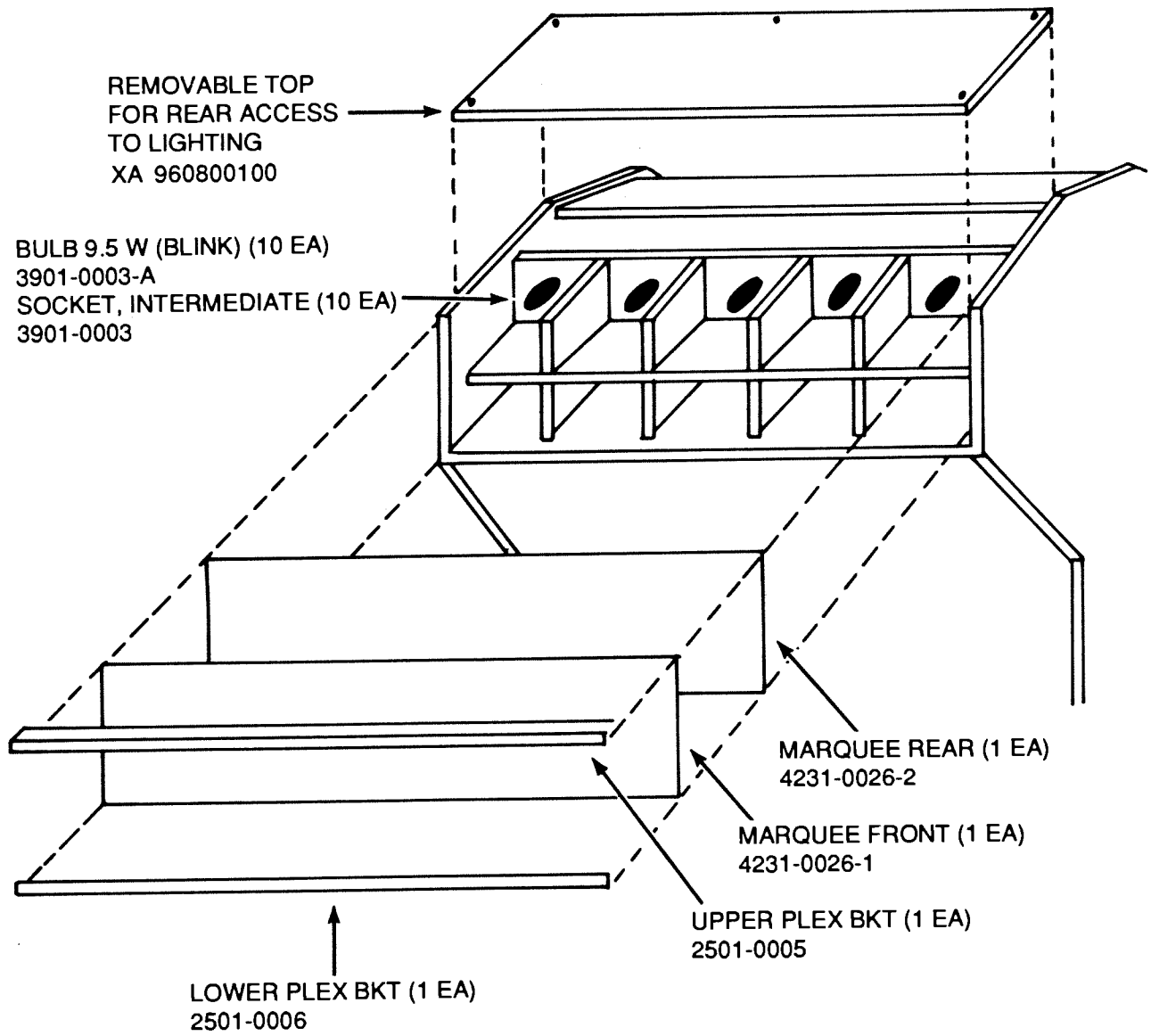

11. DRAWING OF PC ASSEMBLY

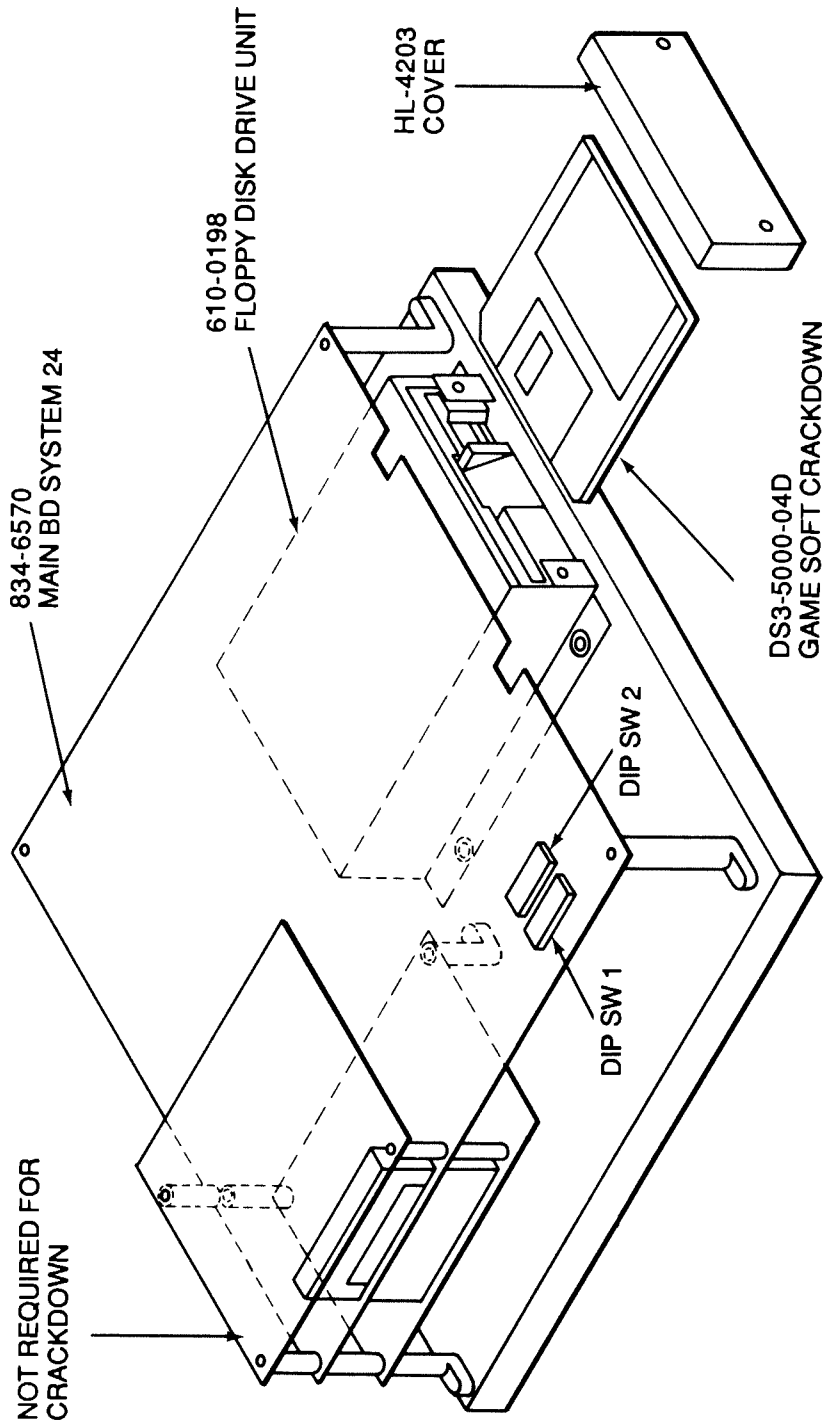

12. PC BOARD COMPONENT LOCATIONS

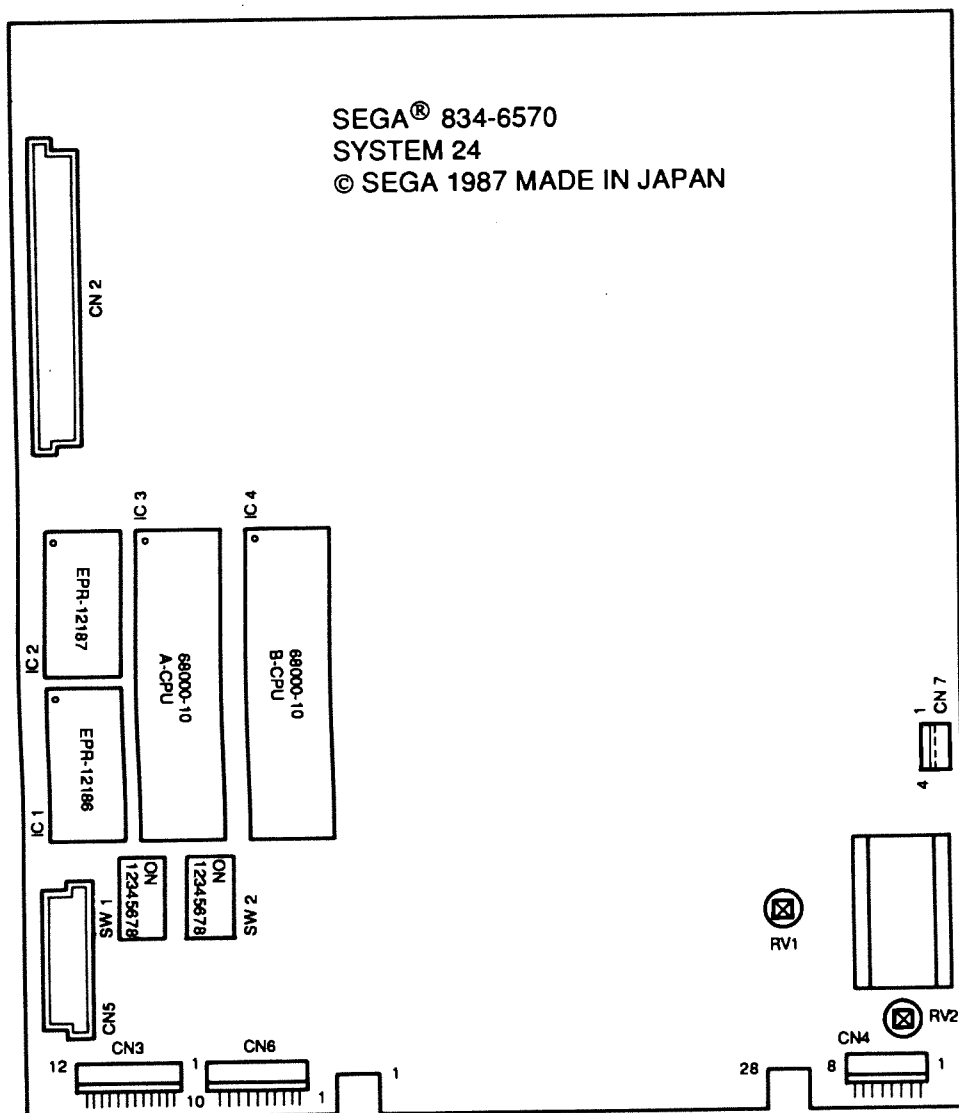

MAIN BD SYS 24

- IC 1 EPR-12186 (IC MB27C1000-15) FOR SYSTEM
- IC 2 EPR-12187 (IC MB27C1000-15) FOR SYSTEM
- IC 3 IC 68000
- IC 4 IC SECURITY CPU 68000 OR IC 68000 FOR GAME PROGRAM
- SW 1 DIP SW
- SW 2 DIP SW
- CN 3 DATA COMMUNICATION CONNECTOR
- CN 6 RESERVE POWER CONNECTOR
- CN 7 INPUT (SOUND) CONNECTOR
- CN 8 HEADPHONE OUTPUT CONNECTOR
- RV 1 MAIN SOUND VOLUME
- RV 2 HEADPHONE SOUND VOLUME

13. MONITOR ADJUSTMENT AND GAME BOARD SERVICING

Monitor Adjustment

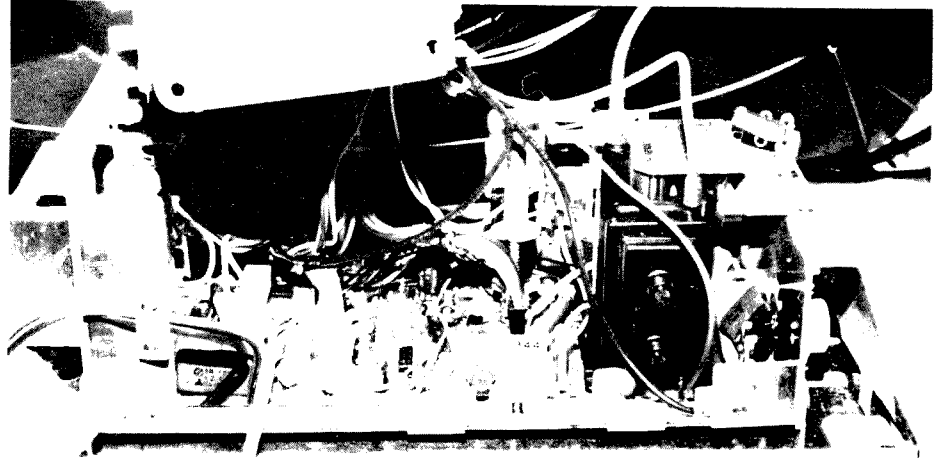

Crackdown Printed Circuit Board

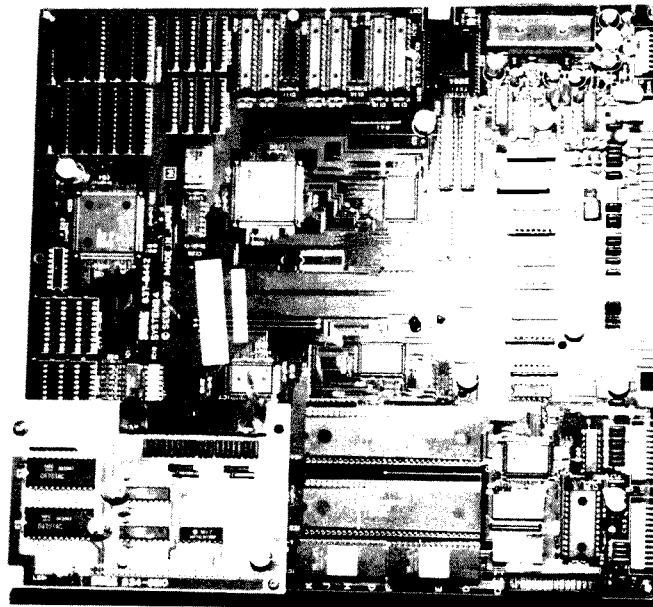

834-6570
SYS 24 PCB

14. PARTS LIST

SEGA SUPPLIED COMPONENTS

PART NUMBER	DESCRIPTION	QTY
000-0308-FS	M SCR PH W/FS M3X8	10
117-5123	NAME PLATE	1
2001-5125-24	MONITOR, 25" MED RES (Wells-Gardner)	1
2501-0005	UPPER PLEX BKT, SS	1
2501-0006	LOWER PLEX BKT, SS	1
317-0058-4D	IC SECURITY, 68000	1
3901-0003	SOCKET, INTERMEDIATE L MOUNT	10
3901-0003-A	BULB 9.5W INTERMEDIATE (BLINK)	10
4201-0006	MANUAL, CRACKDOWN	1
421-5800-98	ORIGINAL SEAL, CRACKDOWN	1
421-6594	SERIAL NO. STICKER	1
421-6709	STICKER, SVC. INSTR	1
421-7209-01	STICKER, FDD COVER ENG.	1
4211-0004	STICKER, SW UNIT (KRO-1721)	1
4211-6120	STICKER, SEGA USA	1
4231-0026-1	MARQUEE, CRACKDOWN (FRONT)	1
4231-0026-2	MARQUEE, CRACKDOWN (REAR)	1
4231-0027	MONITOR CARD, CRACKDOWN	1
4231-0028-1	CONTROL PANEL OVERLAY CD	1
4231-0028-2	DECAL, CONTROL PANEL (LEFT)	1
4231-0028-3	DECAL, CONTROL PANEL (RIGHT)	1
4231-0029-A	SIDE DECAL, TOP (LEFT)	1
4231-0029-B	SIDE DECAL, TOP (RIGHT)	1
4231-0029-C	SIDE DECAL, CENTER	2
4231-0029-D	SIDE DECAL, BOTTOM	2
4231-0029-E	SIDE DECAL, CRACKDOWN	2
4750-0049	RHEOSTAT, 100 OHM 10W	1
5090-5028	SWITCH, PB MOM.	2
5091-0001	JOY STICK 8 WAY (SPRING TYPE)	2
5091-0005-01	PUSHBUTTON, RED (MS)	2
5091-0005-03	PUSHBUTTON, BLU (MS)	2
5601-5126	TRANSFORMER, 160P1	1
600-5661	CONN, FEM 4PX2	1
600-5672	ASSY, FEM/FL CA 34P	1
601-6073	RUBBER GROMMET	4
6010-0043	KNOB, 1/8" SHAFT	1
6010-0420	LINE FILTER, 5A	1
610-0198	ASSY, FDD UNIT	1
834-6570	GAME PCB, SYSTEM 24	1
839-0141	FILTER BOARD	1
DS3-5000-04D	GAME SOFTWARE, CRACKDOWN	1
HL-4202	FDD BASE	1
HL-4203	FDD COVER	1
HL-4204	FDD LID	1
HL-4205	SASH RUBBER 110	1
HL1-4101	SHIELD CASE	1
HL1-4102	SHIELD LID	1
KRO-1721	SERVICE SWITCH BRKT	1

DYNAMO SUPPLIED COMPONENTS

PART NUMBER	DESCRIPTION	QTY
XA800001300	COVER, SPEAKER	1
XA800801800	PANEL, CONTROL HS5 (CRACKDOWN)	1
XA880000201	POWER SUPPLY 5V 11A, 12V 2A	1
XA880000301	HOLDER, FUSE #S-8202-2	1
XA880000501	FUSE, 7 AMP 250V #312007	1
XA880000600	SPEAKER, 5" 8 OHMS	1
XA880001100	HOUSING, COIN (10-1397-09)	1
XA890001500	LEVELER, LEG (331517)	4
XA911500100	GLASS, TEMP NM 1/4X25.75X25.75	1
XA990001400	ASSY, POWER CORD	1
XA880301400	SWITCH, ON/OFF	1
XA860301600	1 PLAYER START BUTTON	1
XA860301700	2 PLAYER START BUTTON	1

15. ADJUSTMENT INSTRUCTION SWITCH SETTING CHART

COIN/CREDIT OPTION SWITCH SETTING DIP SW #1

OPTION	1	2	3	4	5	6	7	8
1 COIN	OFF	OFF	OFF	OFF	OFF	OFF	OFF	OFF
2 CREDITS	ON	OFF	OFF	OFF	OFF	OFF	OFF	OFF
3 CREDITS	ON	ON	OFF	OFF	OFF	OFF	OFF	OFF
4 CREDITS	ON	ON	OFF	OFF	OFF	OFF	OFF	OFF
5 CREDITS	ON	ON	OFF	OFF	OFF	OFF	OFF	OFF
6 CREDITS	ON	ON	OFF	OFF	OFF	OFF	OFF	OFF
1 COIN	ON	ON	ON	ON	ON	ON	ON	ON
2 COINS	ON	ON	ON	ON	ON	ON	ON	ON
3 COINS	ON	ON	ON	ON	ON	ON	ON	ON
4 COINS	ON	ON	ON	ON	ON	ON	ON	ON
5 COINS	ON	ON	ON	ON	ON	ON	ON	ON
1 CREDIT	ON	ON	ON	ON	ON	ON	ON	ON
2 CREDITS	ON	ON	ON	ON	ON	ON	ON	ON
3 CREDITS	ON	ON	ON	ON	ON	ON	ON	ON
4 CREDITS	ON	ON	ON	ON	ON	ON	ON	ON
5 CREDITS	ON	ON	ON	ON	ON	ON	ON	ON
6 CREDITS	ON	ON	ON	ON	ON	ON	ON	ON
1 COIN	ON	ON	ON	ON	ON	ON	ON	ON
2 COINS	ON	ON	ON	ON	ON	ON	ON	ON
3 CREDITS	ON	ON	ON	ON	ON	ON	ON	ON
4 CREDITS	ON	ON	ON	ON	ON	ON	ON	ON
5 CREDITS	ON	ON	ON	ON	ON	ON	ON	ON
6 CREDITS	ON	ON	ON	ON	ON	ON	ON	ON
FREE PLAY	ON	ON	ON	ON	ON	ON	ON	ON
	COIN SW. #1				COIN SW. #2			

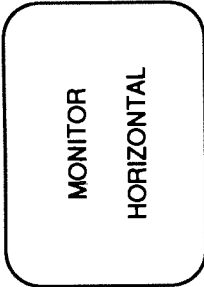
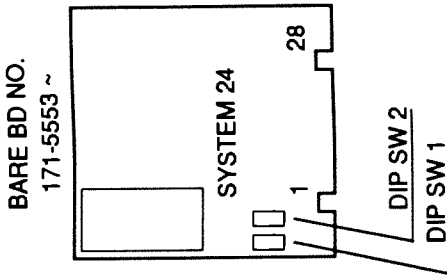

PIN ASSIGNMENT	COMPONENT SIDE	SOLDER SIDE
1 A	GND	GND
2 B	GND	GND
3 C	+5V	+5V
4 D	+5V	+5V
5 E	+12V	+12V
6 F	COIN METER 1	COIN METER 2
7 H	(NOT USED)	(NOT USED)
8 J	(NOT USED)	(NOT USED)
9 K	1P ATTACK	2P ATTACK
10 L	1P SUPER BOMB	2P SUPER BOMB
11 M	(NOT USED)	(NOT USED)
12 N	1P DOWN	2P DOWN
13 P	1P UP	2P UP
14 R	1P RIGHT	2P RIGHT
15 S	1P LEFT	2P LEFT
16 T	(NOT USED)	(NOT USED)
17 U	(NOT USED)	(NOT USED)
18 V	(NOT USED)	(NOT USED)
19 W	(NOT USED)	(NOT USED)
20 X	COIN 1	1P START
21 Y	COIN 2	2P START
22 Z	TEST	(NOT USED)
23 a	SERVICE	(NOT USED)
24 b	SPEAKER (+)	SPEAKER (-)
25 c	RED	GREEN
26 d	BLUE	CMP. SYNC
27 e	GND	GND
28 f	GND	GND

56P P : 3.96mm

★ COIN CHUTE

SINGLE Refers to the one COIN CHUTE TYPE CABINET.

TWIN Refers to the 2 COIN CHUTE TYPE CABINET, in which each chute can accept coins.

In the case of the TWIN COIN CHUTE TYPE, make sure that the settings of coin sw #1 and coin sw #2 are identical.

OPTION SWITCH SETTING

OPTION	1	2	3	4	5	6	7	8
NOT USED	OFF	OFF	OFF	OFF	OFF	OFF		
COIN CHUTE	SINGLE							
	TWIN							
MONITOR	NORMAL							
	REVERSE							
							OFF	ON

★ Set the game difficulty levels, etc., in the TEST MODE.

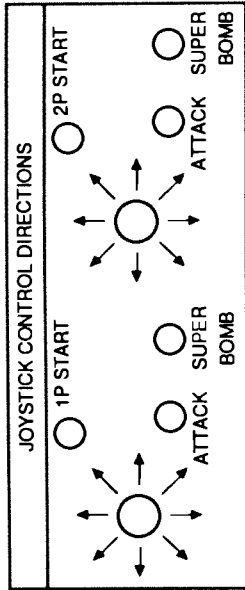

421-7441--01

16. SCHEMATIC DIAGRAM

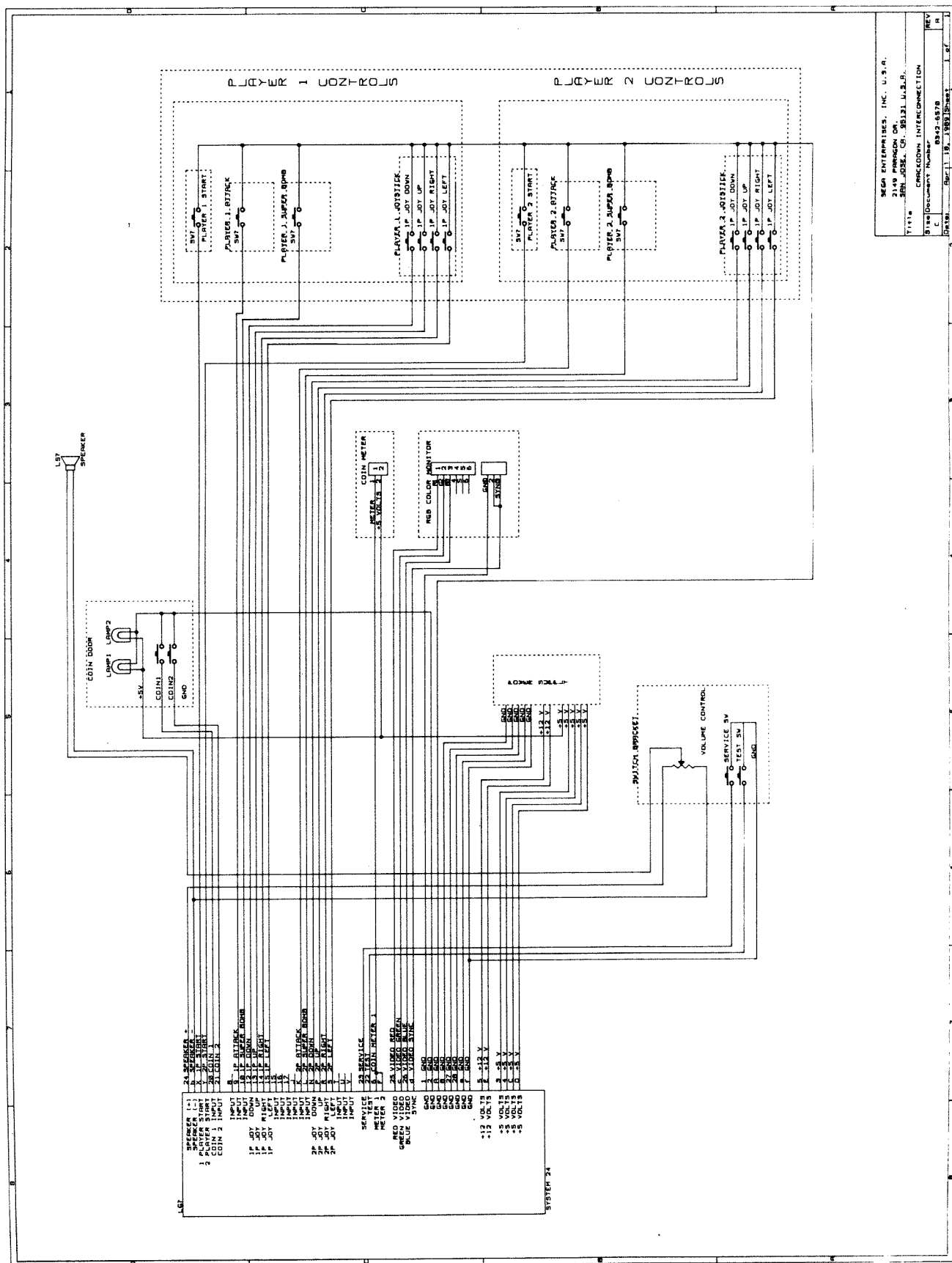

SEGA ENTERPRISES, INC. U.S.A.
 2148 PAVANON DR.
 TITUS, MISSISSIPPI 39321 U.S.A.
 TITLE: CRACKDOWN INTERCONNECTION
 REV: 1
 DOCUMENT NUMBER: 8940-8578
 DATE: 11/19/1983
 DRAWN: 1/27

SEGA ENTERPRISES, INC. (USA)

2149 Paragon Drive
San Jose, CA 95131
Tel. (408) 435-0201
©SEGA 1989