

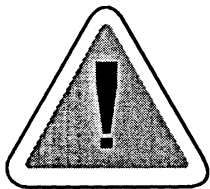

© EIGHTING / RAIZING 2000 ALL RIGHTS RESERVED. PUBLISHING AND DISTRIBUTION BY CAPCOM U.S.A., INC.

OPERATORS MANUAL



WARNING

This game is for use in the United States of America and Canada. Sales, export or operation outside of these countries may be constructed as copyright and trademark infringements and is strictly prohibited. Violators are subject to severe penalties and will be prosecuted to the full extent of the law.

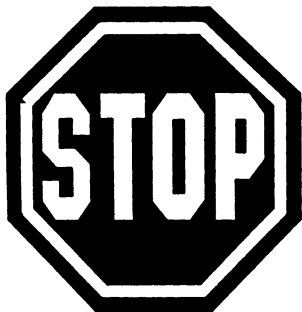

"VERTICAL SCREEN GAME"

Before beginning conversion, please refer to the cabinet manual to insure that the CRT can be changed to the vertical mounting position.

CAPCOM®

DAM1300
030700
000121USA

THANK YOU FOR PURCHASING DIMAHOO™. WE INVITE YOU TO USE THE FOLLOWING MAILING ADDRESS, TELEPHONE OR FAX NUMBER FOR PARTS OR SERVICE INFORMATION CONCERNING THIS GAME:

CAPCOM® COIN-OP, INC.
ATTN: CUSTOMER SERVICE
475 OAKMEAD PARKWAY
SUNNYVALE, CA 94086
PHONE: (408) 522-5327
FAX: (408) 522-5331

THE SERIAL NUMBERS OF YOUR KIT ARE LOCATED ON THE GAME CARTRIDGES AS SHOWN BELOW. PLEASE HAVE THESE SERIAL NUMBERS AVAILABLE WHEN CONTACTING US FOR SERVICE INFORMATION.

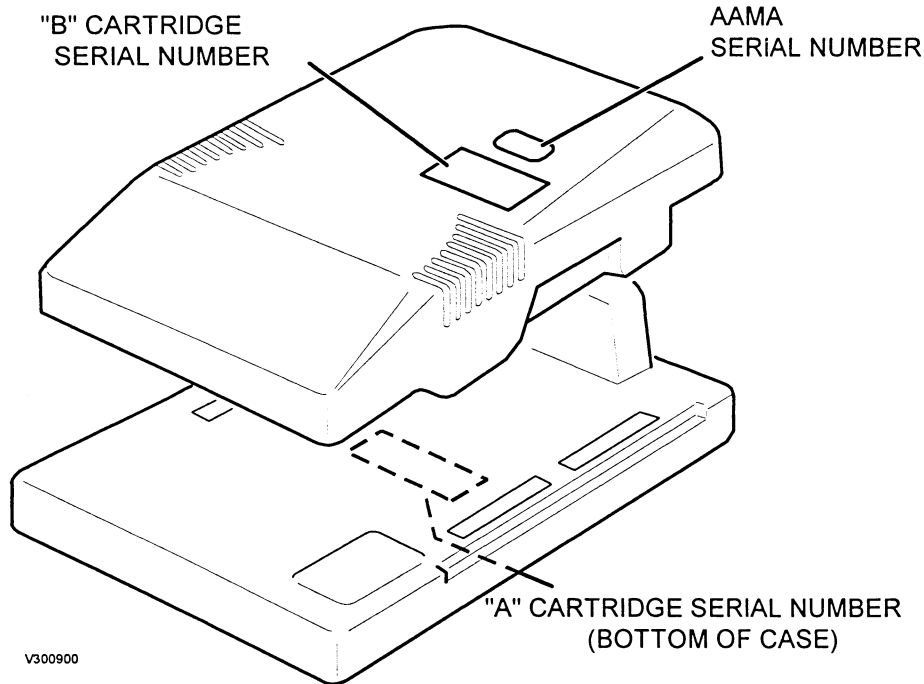

DEPENDING ON THE TYPE OF KIT YOU PURCHASED, PLEASE RECORD THE SERIAL NUMBERS HERE:

"FULL" KIT A-CARTRIDGE SERIAL # _____
 B-CARTRIDGE SERIAL # _____
 AAMA SERIAL # _____

"B" KIT B-CARTRIDGE SERIAL # _____
 AAMA SERIAL # _____

TABLE OF CONTENTS

Warranty Information ii

Kit Inspection 1

Caution 2

“FULL” Kit , “B” Kit

 Preparation 3

 Installation 3, 4

 Control Panel Overlay 3

 Cabinet Graphics 3

 Re-assembly of Components 4

 Remote Volume/Test Switch 4

 Control Panel Wiring 4

 Game Cartridges 5

Test Mode

 Test Menu 6

 Accessing the Menu 6

 How to Select an Item 6

 Closing the Menu 6

 Menu Item Descriptions 6

 Configuration Menu 7

 System Configuration 8

 Game Configuration 9

Wiring References

 Table 1: JAMMA Connections 10

 Table 2: Auxiliary Cable Connections 10

Reference Information Inside of Back-cover

 Game Case Controls and Connectors

 Typical Control Panel Layout

LIMITED PRODUCT WARRANTY (APPLIES TO DOMESTIC SALES ONLY)

CAPCOM® COIN-OP, INC. (Seller), warrants only to the initial purchaser of its products, that the items listed below are free from defects in material and workmanship under normal use and service for the warranty periods specified:

- | | | |
|----|---------------------------------------|--------------|
| A. | CPS II System Cartridges | One (1) Year |
| B. | Electronic and Mechanical Components: | (90) days |

No other part of Seller's products are warranted.

Warranty periods are effective from the initial date of shipment from seller to its authorized distributors.

Seller's sole liability shall be, at its option, to repair or replace products which are returned to Seller during the warranty periods specified, provided:

- A. Seller is notified promptly upon discovery by buyer that stated products are defective;
- B. Such products are properly packaged and then returned, prepaid to Seller's designated plant.

This warranty does not apply to any parts damaged during shipment or handling, or due to improper installation or usage, or alteration. In no event shall Seller be liable for any anticipated profits, loss of profits, loss of use, incidental or consequential damages or any other losses incurred by the customer in connection with the purchase of a CAPCOM® COIN-OP, INC. product.

WARRANTY DISCLAIMER

EXCEPT AS SPECIFICALLY PROVIDED IN A WRITTEN CONTRACT BETWEEN SELLER AND PURCHASER, THERE ARE NO OTHER WARRANTIES, EXPRESSED OR IMPLIED, INCLUDING ANY IMPLIED WARRANTIES OF MERCHANTABILITY OR FITNESS FOR A PARTICULAR PURPOSE.

IMPORTANT NOTICE

THIS SHIPMENT HAS BEEN CAREFULLY INSPECTED AND PROPERLY PACKAGED BEFORE LEAVING THE FACTORY. WE CANNOT ASSUME RESPONSIBILITY FOR BREAKAGE THAT MAY OCCUR DURING TRANSPORTATION OF THE GAME. IF THIS GAME IS DAMAGED UPON RECEIPT FROM THE CARRIER, IMMEDIATELY NOTIFY THE CARRIER AND FILE A DAMAGE REPORT.



"VERTICAL SCREEN GAME"

Before beginning conversion, please refer to the cabinet manual to insure that the CRT can be changed to the vertical mounting position.

KIT INSPECTION

There are two kits available for conversion to *DIMAHOO™*:

1) DAM1000 ("FULL" kit) contains the complete game cartridges, all necessary graphics, and replacement joysticks and button switches. The "FULL" kit is intended for conversion of most JAMMA-compatible, horizontal screen cabinets.

2) DAM 1000B ("B" kit) contains the game software cartridge (B-cartridge) and must also be installed to a current CAPCOM® System II game. It includes all the necessary game graphics for a cabinet conversion (marquee, control panel overlay, monitor card, etc.).

Check that all parts have been shipped with your kit.

If any parts are missing, contact your distributor immediately.

KIT PARTS LIST

DAM1000	DAM1000B	PART NO.	DESCRIPTION	QTY
√		DAM1400	CPS II System Cartridges (A/B)	1
	√	DAM1400B	CPS II System Cartridge (B)	1
√	√	GE1200	Monitor Card	1
√	√	DAM1110	Marquee	1
√	√	AW00216	Control Panel Overlay	1
√	√	PI00376	Marquee Plex 27x9	1
√	√	DAM2510	Decal, Joystick & Button Switches	1
√	√	DAM2520-01	Decal - Instruction Top	1
√	√	DAM2520-02	Decal - Instruction Bottom.	1
√	√	DAM1300	Operators Manual	1
√	√	AW00147	Cabinet Side Decal	2
√		GE2030	Joystick, 8-way	2
√		16-0130	Switch, 1-Player Start Button (White)	1
√		16-0131	Switch, 2-Player Start Button (White)	1
√		16-00133	Switch, Button (Red)	2
√		16-00134	Switch, Button (Blue)	2
√		03-0052 or 0066	Auxiliary Cable (Volume Control)	1
√		13-0066	Cartridge Mounting Bracket	4

Note: Because of availability, your kit may contain different color of push-buttons.

CAUTION

Please read the following instructions to keep the PC board in good condition:

- ◆ Do not block the ventilation slots.
- ◆ Do not drop or bump the board.
- ◆ Do not spill any liquids on the case.
- ◆ Do not disassemble the case.

ATTENTION

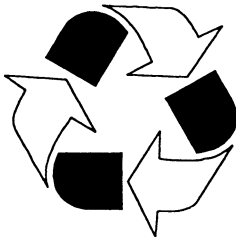

The product that you have purchased contains a recyclable battery. At the end of its useful life, under various state and local laws, it may be illegal to dispose of this battery into the municipal waste system. Check with your local solid waste official for details in your area for recycling options or proper disposal.

**DISASSEMBLING THE CASE OR REMOVING
THE STICKER MAY CAUSE THE TERMINATION
OF YOUR REPAIR WARRANTY.**

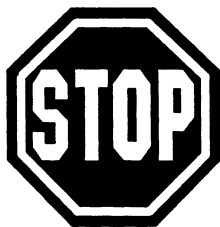

"VERTICAL SCREEN GAME"

Before beginning conversion, please refer to the cabinet manual to insure that the CRT can be changed to the vertical mounting position.

KIT INSTALLATION



WARNING:

"VERTICAL SCREEN GAME".

Before beginning conversion, please refer to the cabinet manual to insure that the CRT can be changed to the vertical mounting position.

MAKE SURE ELECTRICAL POWER TO THE GAME IS OFF BEFORE STARTING THE KIT INSTALLATION.

PREPARATION

1. Disconnect and remove the old printed circuit board(s) from the cabinet.
2. Remove or open the control panel, and disconnect and remove the buttons and joystick(s) from the control panel.
3. Remove any covering from the control panel overlay, and then remove the control panel overlay.
4. Center punch any needed new holes on the control panel.
5. Cut out the new holes using a 1-3/16" hole saw.
6. If there is an additional control panel cover, figure 1 (such as plastic or lexan) that will be utilized, cut any additional holes using the same template. *cover is not included in the kit.
7. Plug up unused holes with a wood dowel (1-1/8" diameter) and sand any rough edges.

INSTALLATION

Marquee Installation

8. Remove the marquee plexi glass, marquee overlay, and the cabinet graphics.
9. Install the new marquee and replace the plexi glass. Clear plexi glass is included in "full" kit.

Control Panel Overlay Installation (See Figure 1)

10. The control panel overlay in the kit is oversized to accommodate most control panel sizes. Center the overlay on the control panel, leaving some excess material at the edges.
11. Remove the protective backing from the overlay and press it down on the control panel, keeping it properly aligned. Press it down firmly, smooth out any bubbles, and press it over the edges.
12. Trim any excess from the overlay. Place the drill hole template on top of the overlay, aligning it with the joystick holes. Pierce through the overlay at each control panel hole. Then, cut away overlay material covering the joystick and button holes. Remove the template and clean off the overlay.

13. Peel off the backings of the 6-button and joystick decals, align over the control panel holes, and press in place on the overlay (refer to the drill hole template for proper placement). Using a knife, trim material from the center hole of the joystick decal.

14. Install the control panel cover, figure.1. (if required).

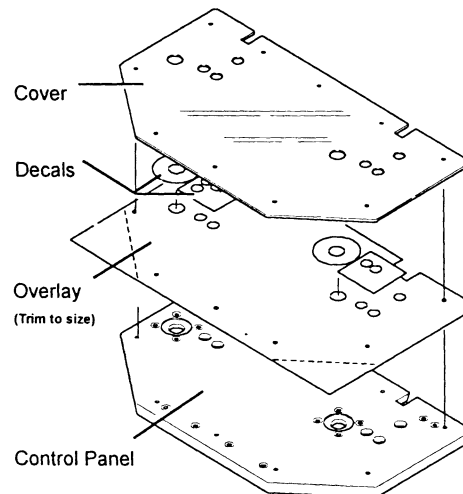

Figure 1: Overlay Installation

CABINET DECAL INSTALLATION

19. Remove monitor glass and install monitor card
20. Peel-off the backing to the instruction decals and place on both the top and bottom of the monitor card. (See Figure 5). Also, apply the cabinet decals to both sides of the cabinet.

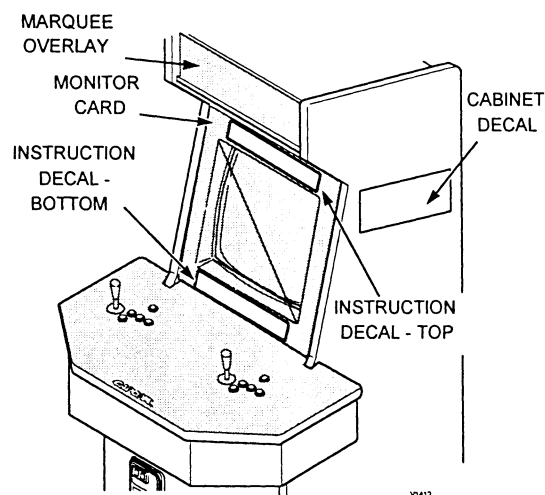

Figure 5: Cabinet Decal Installation

Re-assembly of Components

15. Notice that there are two white buttons. See figure 2. The WHITE buttons are START buttons. Install the PLAYER ONE button on the top left-hand side of the control panel, and the player two button on the top right-side of the control panel.

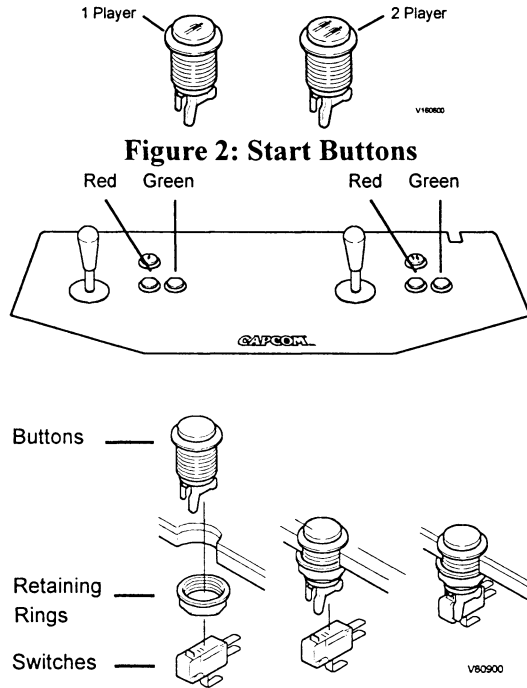

Figure 2: Start Buttons

Figure 3: Control Panel Buttons and Switches

16. Install all buttons and retaining rings on the control panel as shown in Figure 3. Install two red buttons to the immediate right of each joystick, install two green buttons to the right of the red ones, and install two blue buttons to the right of the green ones.

17. Install the switches on the buttons as shown in figure 3. Orient the switches so that when a button is pressed, the plastic contact on the switch is depressed.

18. Install the joysticks on the control panel as shown in figure 4.

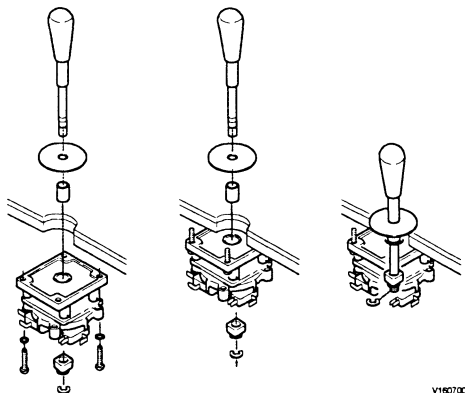

Figure 4: Joystick Installation

CONTROL PANEL WIRING

NOTE: all switch wires used in this game must be wired to the normally-open connection on the switches. Each switch requires a ground wire on the common connector and the appropriate control or switch wire on the normally-open connector of the switch.

21. Reconnect the existing JAMMA connectors to the control panel according to the chart in table 1.

22. The kick button harness is not used.

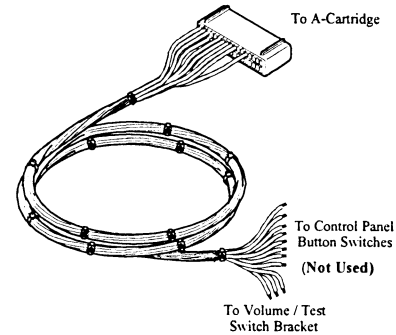

Figure 6: Auxiliary Cable Harness

TEST SWITCH WIRING

23. Your cabinet may already be equipped with a test switch. An optional test/volume bracket (see Figure 7) is available through your local CAPCOM distributor (part number 03-0050). When installing, the test switch bracket should be mounted inside the coin door and on top of the cash box for easy access. (See Page 7 for wiring detail)

NOTE: The test switch, the volume up/down switches are used for this game. Kick buttons are not used. Volume adjustments could be made through the volume control knob located on the PC board.

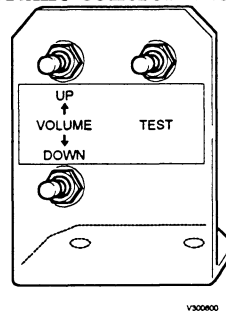



Figure 7: Test Switch Bracket

24. If you are converting a cabinet that is equipped with CAPCOM® Q-SOUND, you may use stereo audio output connect to existing Q-SOUND POWER AMPLIFIER.



CAUTION

IMPROPER INSTALLATION OF THE JAMMA HARNESS TO THE GAME CARTRIDGE WILL CAUSE DAMAGE TO THE ENCLOSED PCB.



WARNING

DISASSEMBLY OF EITHER GAME CARTRIDGE WILL VOID YOUR WARRANTY.

GAME CARTRIDGE INSTALLATION

“FULL” KIT

20. Install the four (4) mounting brackets to the underside of the “A” cartridge as shown in Figure 10.

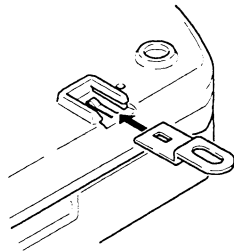

Figure 10: Mounting Bracket Installation

21. Using the wood screws (Not Supplied), fasten the game cartridge case to the control panel shelf, as shown in Figure 11.

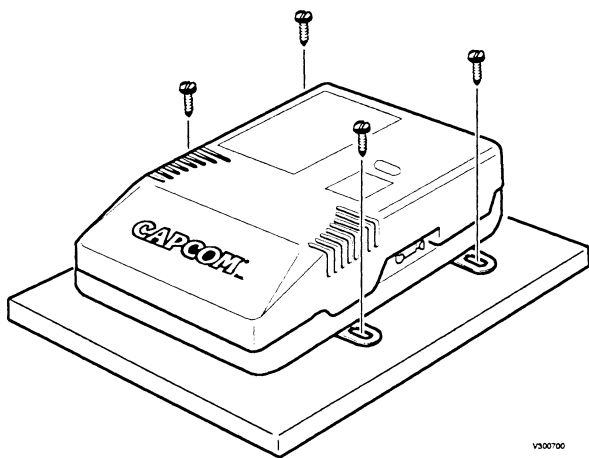

Figure 11: Case Mounting

22. Connect the JAMMA harness connector and the auxiliary cable connector to the “A” cartridge. If your cabinet is equipped with Q·SOUND, also attach the audio cables.

“B” KIT

15. To remove the existing “B” cartridge from the “A” cartridge, pull the old case clamps apart (see Figure 12). Carefully remove the old “B” cartridge and install the new “B” cartridge. Re-install the case clamps.

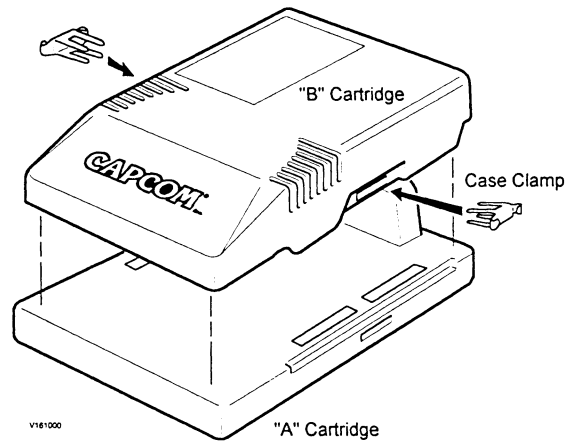
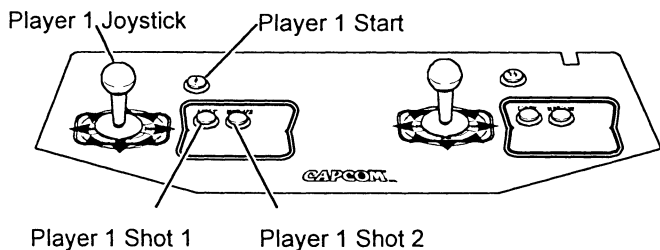

Figure 12 : Case Clamp Installation

23. Power-up the game and set all operator adjustable options by pressing the TEST switch. Follow the instructions under the TEST MENU section of this manual.

TEST MENU

The test menu allows you to test the functions and configure the game. These items include input devices such as joysticks, buttons and coin door or switches, output devices such as monitor, speakers and meters. Through the Test Menu you can also access the Configuration Menu, where you can change the settings of the game.



1. ACCESSING THE TEST MENU

- For a CAPCOM® cabinet, or a cabinet with a test switch:

Make sure the game is on and push the test switch. The screen shown left will appear.

- For a cabinet without a test switch:

Push the blue test switch on the outside of the black plastic casing.

Refer to the inside back cover of the manual.

2. HOW TO SELECT AN ITEM

- Use the *PLAYER 1 JOYSTICK* to move the arrow in front of the desired item and press the *PLAYER 1 SHOT 1* button, as shown below in various control panel configurations:

3. CLOSING THE TEST MENU

To close the Test Menu, highlight “9. EXIT” and push the *PLAYER 1 SHOT 1* button.

- To return to the test menu, push the *PLAYER 1 START* and *PLAYER 1 SHOT 1* buttons simultaneously.
- The test menu will always return to the screen:
 - a) After you exit the “7. CONFIGURATION MENU” and
 - b) After the memory is tested from the menu, “8. MEMORY CHECK”.

4. TEST MENU ITEM DESCRIPTIONS

INPUT	Used to test all the input switches, such as joysticks and buttons. The “0” changes to a “1” as the button is pushed or joystick is moved. Check connections and switches in case the “0” doesn’t change to a “1” when depressed or moved.
OUTPUT	Used to test the coin meter and the coin lock.
SOUND & VOICE	Select a code of SOUND or VOICE with the <i>PLAYER 1 JOYSTICK</i> . Push the <i>PLAYER 1 SHOT 1</i> button to hear the sound of the selected code.
COLOR	Shows color bars of red, green, blue, and white. Adjust RGB and brightness to obtain the optimum color balance and solid black background.
DOT CROSS HATCH	Used to test the screen size, focus and distortion.
GAME DATA	Coin meter, Free Game and Free play information will be displayed.
CONFIGURATION	Used to change the game play settings. Refer to the CONFIGURATION MENU section.
MEMORY CHECK	Used to test memory. “OK” appears when each block of memory passes test, “NG” appears in case of malfunction. If “NG” appears, repeat the memory test and wait for the “OK” message. Contact your distributor if “NG” still appears.
EXIT	Select this item and push the <i>PLAYER 1 SHOT 1</i> button to return to game play mode.

CONFIGURATION MENU

The Configuration Menu is used to change various game settings such as level difficulty, credits, sound configuration, etc. These settings are stored in memory on the PCB.

The Configuration Menu is divided into 2 sections. In the **SYSTEM** section, you can change credits, sound, and coin door configurations. In the **GAME** section, you can change the play difficulty level and duration of the game.

7. CONFIGURATION MENU

- > 1. SYSTEM
- 2. GAME
- 3. DEFAULT
- 4. SAVE&EXIT

SELECT = 1PUPORDOWN
START = 1PSHOT1

1. ACCESSING THE CONFIGURATION MENU

- From the TEST MENU, move the arrow to “7. CONFIGURATION” and push the *PLAYER 1 SHOT 1* button. The screen left will be displayed. A description of each option is explained in the table below.

5. CONFIGURATION MENU ITEM DESCRIPTIONS

SYSTEM	Select this item to change settings for credits, monitor flip, sound and coin door configurations.
GAME	Select this item to change difficulty level, damage level, time count speed, maximum number of rounds and event type.
DEFAULT	Use this item to restore configuration settings to the original factory values. Press the <i>PLAYER 1 SHOT 1</i> and <i>PLAYER 1 SHOT 2</i> buttons at the same time to restore default values.
SAVE & EXIT	Use this to save new configuration settings and exit to the Test Menu. The message “SAVING NEW CONFIGURATION IN EE-PROM” will appear while the new settings are being saved. DO NOT turn power off to the game until “SAVING” is complete and the Test Menu reappears.

SYSTEM CONFIGURATION

7-1. SYSTEM CONFIGURATION

- 1. COIN MODE 1 COIN 1 CREDIT
- 2. CHUTE TYPE 2 CHUTES SINGLE
- 3. CONTINUE ON
- 4. MONITOR NORMAL
- 5. DEMO SOUND ON
- 6. SOUND MODE STEREO (Q SOUND)

- 7. EXIT

SELECT OPTION = 1P UP OR DOWN
 MODIFY SETTING = 1P LEFT OR RIGHT

CHANGING THE SYSTEM CONFIGURATION SETTINGS

Move the *PLAYER 1 JOYSTICK* up or down to highlight the desired option. Once the option is highlighted, move the *PLAYER 1 JOYSTICK* left or right to select.

SYSTEM CONFIGURATION ITEM DESCRIPTIONS

1. COIN MODE	SELECT THE CHARGE PER PLAY.
2. CHUTE TYPE	SELECT THE NUMBER OF PLAYER(S) AND COIN CHUTE TYPE.
3. CONTINUE	SELECT ON FOR CONTINUOUS PLAY OR OFF FOR NON-CONTINUOUS PLAY.
4. MONITOR	FLIPS THE POSITION OF THE SCREEN. IF THE SCREEN APPEARS UPSIDE-DOWN, CHANGE THE SETTING TO FLIP; IF THE SCREEN APPEARS CORRECT, SELECT NORMAL.
5. DEMO SOUND	TURNS ATTRACT SOUNDS "ON (Standard)", "HALF (Half of standard)", OR "OFF". "HALF" SETTING ALLOW YOU TO LOWER THE ATTRACT SOUND TO HALF OF THE GAME SOUND LEVEL WITHOUT AFFECTING THE GAME SOUND ADJUSTMENT.
6. SOUND MODE	SELECT STEREO OR MONAURAL FOR USE WITH YOUR CABINET. NOTE: STEREO SHOULD ONLY BE SELECTED FOR USE WITH CAPCOM® Q SOUND CABINETS.
7. EXIT	TO SAVE THE SETTINGS AND RETURN TO THE CONFIGURATION MENU, HIGHLIGHT THIS ITEM AND PUSH EITHER THE <i>PLAYER 1 SHOT 1</i> BUTTON.

SYSTEM CONFIGURATION OPTION SETTINGS

1. COIN MODE	1 COIN 1 CREDIT	1 COIN 2 CREDITS	1 COIN 3 CREDITS	1 COIN 4 CREDITS	1 COIN 5 CREDITS
	1 COIN 6 CREDITS	1 COIN 7 CREDITS	1 COIN 8 CREDITS	1 COIN 9 CREDITS	2 COINS 1 CREDIT
	3 COINS 1 CREDIT	4 COINS 1 CREDIT	5 COINS 1 CREDIT	6 COINS 1 CREDIT	7 COINS 1 CREDIT
	8 COINS 1 CREDIT	9 COINS 1 CREDIT	2 COINS START 1 COIN CONTINUE		FREE PLAY
2. CHUTE TYPE	2 CHUTES SINGLE		2 CHUTES MULTI	1 CHUTE SINGLE	
3. CONTINUE	ON			OFF	
4. MONITOR	NORMAL		1/2 (HALF)	FLIP	
5. DEMO SOUND	ON			OFF	
6. SOUND MODE	STEREO (Q SOUND)			MONAURAL	

NOTE: **FACTORY SETTING**

GAME CONFIGURATION

7-2. GAME SETTINGS

- > 1. PLAYER STOCK 3
- 2. BOMBER STOCK 3
- 3. GAME DIFFICULTY EASY[****4****]HARD
- 4. EXTENDED TYPE 2,000,000 AND 5,000,000
- 5. STAGE TYPE 1 LOOP
- 6. INVINCIBLE OFF

7. EXIT

RETURN TO
CONFIGURATION MENU
SELECT OPTION = 1P UP OR DOWN
MODIFY SETTING= 1P LEFT OR RIGHT

CHANGING THE GAME CONFIGURATION SETTINGS

Move the *PLAYER 1 JOYSTICK* up or down to highlight the desired option. Once the option is highlighted, move the *PLAYER 1 JOYSTICK* left or right to select.

ITEM	DESCRIPTION	OPTION SETTINGS			
		1	2	3	4
1. PLAYER STOCK	SETS THE INITIAL NUMBER OF AIRCRAFTS.	1	2	3	4
2. BOMBER STOCK	SETS THE INITIAL NUMBER OF BOMBS.	0	1	2	3
3. GAME DIFFICULTY	SETS THE GAME DIFFICULTY LEVEL	1 EASY	2	3	4
		5	6	7	8 HARD
4. EXTENDED TYPE	SETS THE CONDITION OF EXTRA SHIP TO GIVE.	2,000,000 AND 5,000,000		2,000,000 ONLY	4,000,000 ONLY
		EVERY 2,000,000	EVERY 4,000,000	NO EXTEND	
5. STAGE TYPE	SETS HOW MANY TIMES A PLAYER NEEDS TO COMPLETE THE ENTIRE GAME.	1 LOOP		2 LOOPS	
3. INVINCIBLE	IF YOU SET THIS TO "ON", YOU CAN PLAY THE GAME WITHOUT RECEIVING DAMAGE. <i>"USE ONLY FOR TEST PURPOSE"</i>	OFF		ON	
4. EXIT	RETURN TO THE CONFIGURATION MENU.				

NOTE: **FACTORY SETTING**

Table 1: JAMMA Connections

SOLDER SIDE			COMPONENT SIDE
GND	A	1	GND
GND	B	2	GND
+5V DC	C	3	+5V DC
+5V DC	D	4	+5V DC
N/C	E	5	N/C
+12V DC	F	6	+12V DC
KEY	H	7	KEY
N/C	J	8	COIN COUNTER 1
COIN LOCK 2	K	9	COIN LOCK 1
*SPEAKER (-)	L	10	*SPEAKER (+)
N/C	M	11	N/C
VIDEO GREEN	N	12	VIDEO RED
VIDEO SYNC	P	13	VIDEO BLUE
SERVICE (FREE CREDIT)	R	14	VIDEO GROUND
N/C	S	15	DIAGNOSTICS
2 PLAYER · COIN	T	16	1 PLAYER · COIN
2 PLAYER · START	U	17	1 PLAYER · START
2 PLAYER · UP	V	18	1 PLAYER · UP
2 PLAYER · DOWN	W	19	1 PLAYER · DOWN
2 PLAYER · LEFT	X	20	1 PLAYER · LEFT
2 PLAYER · RIGHT	Y	21	1 PLAYER · RIGHT
2 PLAYER · SHOT 1	Z	22	1 PLAYER · SHOT 1
2 PLAYER · SHOT 2	a	23	1 PLAYER · SHOT 2
N/C	b	24	N/C
N/C	c	25	N/C
N/C	d	26	N/C
GND	e	27	GND
GND	f	28	GND

Table 2: Auxiliary Cable (P/N 03-0052) Connections

WIRE COLOR	CONNECTOR ODD ROW			CONNECTOR EVEN ROW	WIRE COLOR
	N/C	1	2	N/C	
	N/C	3	4	N/C	
	N/C	5	6	N/C	
	N/C	7	8	N/C	
PURPLE/YELLOW	N/C	9	10	N/C	
	N/C	11	12	N/C	
	N/C	13	14	N/C	
PINK	N/C	15	16	N/C	
RED	N/C	17	18	N/C	
BLUE	N/C	19	20	N/C	
GRAY/YELLOW	N/C	21	22	N/C	
PINK/YELLOW	N/C	23	24	N/C	
	N/C	25	26	N/C	
	N/C	27	28	N/C	
GRAY/YELLOW	TEST BRKT-VOLUME UP	29	30	TEST BRKT-VOLUME DOWN	PINK/YELLOW
BLACK/WHITE	TEST BRKT-VOLUME COMMON	31	32	N/C	
BLACK	N/C	33	34	N/C	BLACK

REFERENCE INFORMATION

GAME CASE CONTROLS

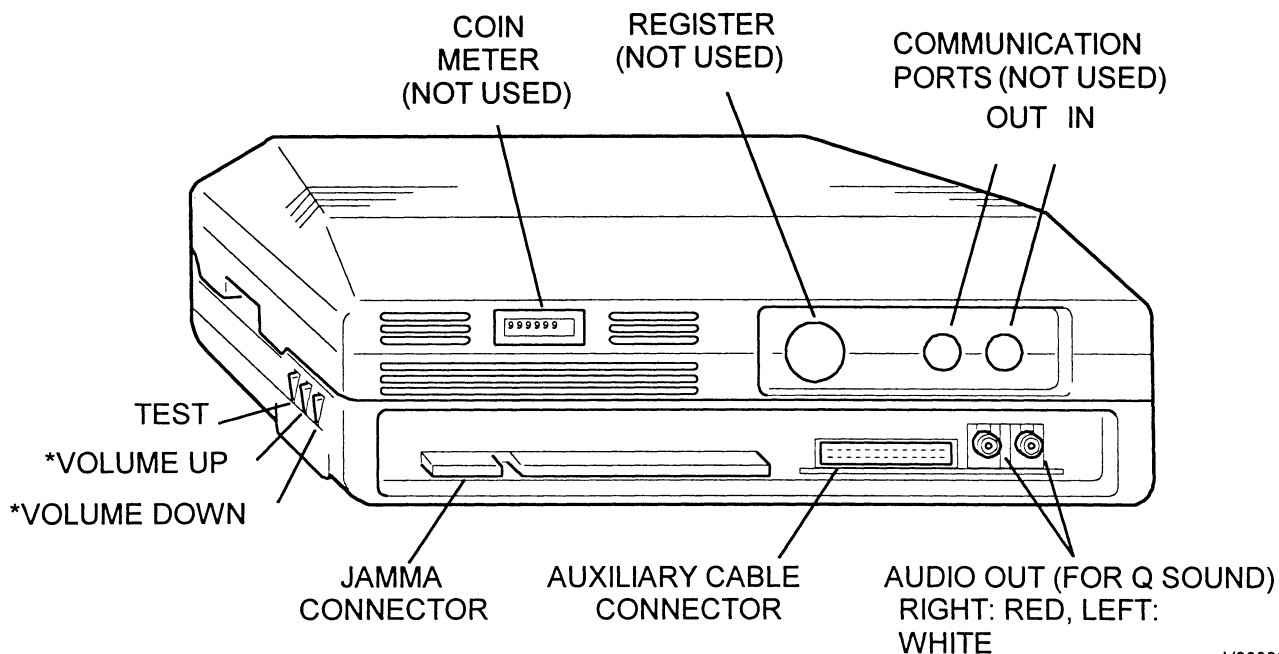

V300800

TYPICAL CONTROL PANEL LAYOUTS FOR "DIMAHOO™"

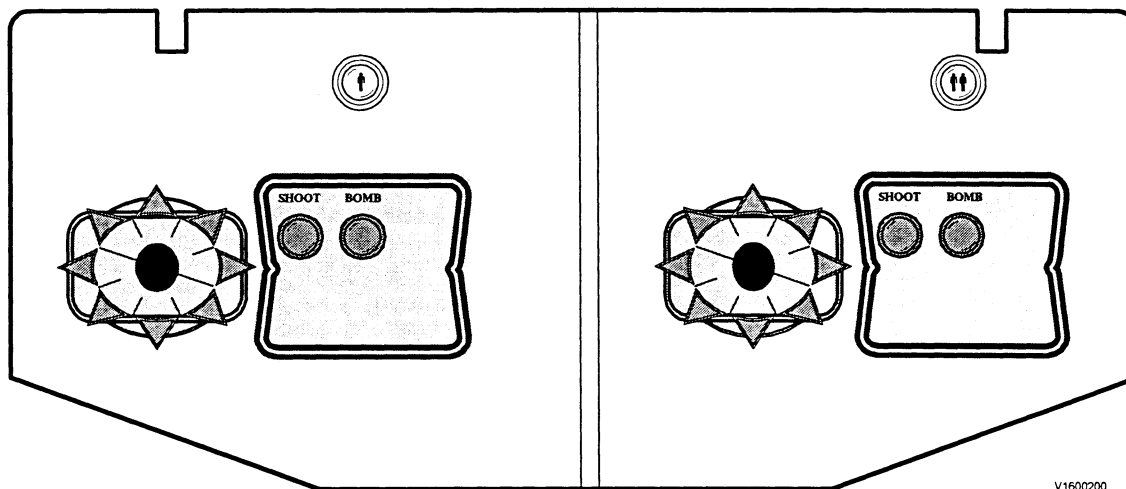

V1600200



"VERTICAL SCREEN GAME"

Before beginning conversion, please refer to the cabinet manual to insure that the CRT can be changed to the vertical mounting position.

WARNINGS & NOTICES

WARNING

A very small portion of the population has a condition which may cause them to experience epileptic seizures or have momentary loss of consciousness when viewing certain kinds of flashing lights or patterns that are present in our daily environment. These persons may experience seizures while watching some kinds of television pictures or playing certain video games. People who have not had any previous seizures may nonetheless have an undetected epileptic condition.

If you or anyone in your family has experienced symptoms linked to an epileptic condition (e.g. seizures or loss of awareness), immediately consult your physician before using any video games. We recommend that parents observe their children while they play video games. If you or your child experience the following symptoms: dizziness, altered vision, eye or muscle twitching, involuntary movements, loss of awareness, disorientation, or convulsions, DISCONTINUE USE IMMEDIATELY

WARNING

Federal law provides severe civil and criminal penalties for the unauthorized reproduction, distribution, or exhibition of copyrighted audiovisual works and video games.

The Federal Bureau of Investigation investigates allegations of criminal copyright infringement.

NOTICE

This equipment has been tested and found to comply with the limits for a Class A digital device, pursuant to Part 15 of the FCC Rules. These limits are designed to provide reasonable protection against harmful interference when the equipment is operated in a commercial environment. This equipment generates, uses, and can radiate radio frequency energy and, if not installed and used in accordance with the instruction manual, may cause harmful interference to radio communications. Operation of this equipment in a residential area is likely to cause harmful interference, in which case the user will be required to correct the interference at his own expense.

NOTICE

Information in this manual is subject to change without notice. CAPCOM COIN-OP, INC. reserves the right to make improvements in equipment function, design, or components as progress in engineering or manufacturing methods may warrant.

NOTICE

No part of this publication may be reproduced by any mechanical, photographic, or electronic process, or in the form of a photographic recording, nor may be transmitted, or otherwise copied for public or private use, without permission from the publisher.

CAPCOM[®] COIN-OP, INC.

475 Oakmead Parkway

Sunnyvale, CA 94086

Phone: (408) 774-0500

Fax: (408) 522-5331