

GATE OF DOOM™

INSTALLATION & SERVICE MANUAL



DATA EAST USA, INC.

1850 Little Orchard Street
San Jose, California 95125
Telephone (408) 286-7080

780-0173-00

FCC WARNING

This equipment generates and uses radio frequency energy and if not installed and used properly, ie; in strict accordance with this instruction manual, may cause harmful interference to radio communications. This equipment has been tested and found to comply with the limits for a class A computing device pursuant to Subpart J of Part 15 of the FCC rules, which are designed to provide reasonable protection against such interference when the equipment is operated in a commercial environment.

Operation of this equipment in a residential environment is likely to cause interference in which case the user, at his own expense, will be required to take whatever measures are necessary to correct the interference.

FBI WARNING

Federal law provides severe civil and criminal penalties for the unauthorized reproduction, distribution, or exhibition of copyrighted audio-visual works and video games. The Federal Bureau of Investigation investigates allegations of criminal copyright infringement.

COPYRIGHT NOTICE

GATE OF DOOM™ is Copyright 1990, DATA EAST USA, INC., sold exclusively in the United States of America and Canada by DATA EAST USA, INC. All rights reserved.

ENVIRONMENTAL DATA

This product is intended for indoor use only! Power requirements are 105-125 volts AC, 50 - 60 Hz. This equipment requires a three (3) wire grounded outlet.

SERVICE PROCEDURES

To obtain replacement parts and technical service, contact the authorized Data East Distributor in your area. If you require referral or further technical assistance, you may contact Data East's Customer Service Department during the hours of 8:00 AM to 5:00 PM, Pacific Time, at (408) 286-7080.

AAMA WARNING

DATA EAST USA, INC., in cooperation with the American Amusement Machine Association (AAMA), has installed an "AAMA PROTECT" certification label on each GATE OF DOOM™ PCB manufactured for legal sale in the United States of America.

If you are offered a GATE OF DOOM™ PCB that does not have the "AAMA PROTECT" certification label, or if the PCB serial number (located on the "Original Product Seal" has been tampered with, you should suspect that the board is not legal, and should contact DATA EAST USA, INC. at (408) 286-7080, or contact the AAMA directly at (319) 337-9618 [Bill Kidwell] or (703) 548-8044 [Bob Fay].

GATE OF DOOMtm

UPRIGHT GAME and CONVERSION KIT

Table of Contents

1.	UPRIGHT GAME	
	A. Installation and Setup.....	1
	B. System Adjustments.....	2
	C. Replacement Parts Lists.....	3
2.	CONVERSION KIT	
	A. Specific Requirements.....	5
	B. Replacement Parts List.....	5
	C. Installation Instructions.....	6
3.	GAME INFORMATION	
	A. Game Play Instructions.....	10
	B. Game Options.....	11
	C. PCB Edge Connector Pin-outs.....	12
4.	CUSTOMER REPLY FORM.....	15
5.	WARRANTY INFORMATION..Inside Back Cover	

© 1990 DATA EAST USA, INC.
1850 Little Orchard Street
San Jose, CA 95125

GATE OF DOOM™

UPRIGHT GAME

1. A. INSTALLATION AND SET UP

Thank you for buying a DATA EAST product. We are sure that you will enjoy many years of profitable and entertaining operation with your GATE OF DOOM™ game.

This manual is written for GATE OF DOOM™ upright games shipped in DATA EAST cabinets which have the "works in a drawer."

Your game was thoroughly tested, 'burned-in' and inspected before it was shipped. However, it may have been subjected to some rough handling, or a rough ride in a truck, since it left our factory, so please follow the steps listed below before attempting to operate the game.

Locate the door keys supplied, open the coin door, and remove the Rear Access Door.

Reach through the open coin door and unlatch the control panel. Unlatch the "works" drawer and slide it out of the cabinet until it can be restrained by the side, control panel gusset.

Check the Main Harness for loose or unplugged connectors, and check for secure mounting of the monitor, power supply, and game pcb. Stabilize the cabinet using the leg levelers in the floor of the cabinet to prevent the game from rocking.

The selectable options have been pre-set at the factory for optimum player appeal. However, to set the game up for your specific requirements, refer to the operator selectable options on Page 11 in Chapter 3, Section A of this manual.

Remove the power cord from the inside of the cabinet and insert it into the slot at the bottom of the rear access door opening. Plug the AC cord into a grounded 117 VAC outlet and flip the power switch to the ON position. Allow 2 to 3 minutes for the monitor to warm up and check for proper demonstration mode video on the screen. Insert the proper coinage into a coin slot and start a game. Check for proper operation of all joystick controls and switches.

GATE OF DOOM™ UPRIGHT GAME

1. B. SYSTEM ADJUSTMENTS

The Volume Control, Coin Counter, and Service Switch are located on the Service Panel. The Service Panel is located inside the Coin Door.

The Coin Counter increments once for every coin dropped through either coin entry slot.

GATE OF DOOM™ utilizes monophonic sound. A single Volume Control is used to adjust the overall loudness of the game sounds. NOTE: The volume control potentiometer on the Main PC Board is pre-set to mid-range at the factory and should not be adjusted.

The Service Switch can be used to add credits to the game without incrementing the Coin Counter.

The fuses for the AC power line and the 12 volt Supply are located on the DRAWER ASSEMBLY. The fuse holders are labeled as to the proper fuse ratings. The line fuse should be 3 A slow blow, and the 12 volt fuse (used for coin door lamp circuit) should be 1 A fast blow.

The +5 vdc adjustment level control on the Power Supply's Switching Regulator is pre-set at the factory. In the event that an adjustment is required, measure the +5 volt level present at the game logic pcb with a Digital Multi-Meter while adjusting the output level of the Switching Regulator. The voltage must measure between +4.90 vdc to 5.10 vdc at the game logic pcb for proper operation.

**WARNING: DANGEROUS VOLTAGE LEVELS ARE PRESENT IN
AND AROUND THE MONITOR AND POWER SUPPLY ASSEMBLY.
ADJUSTMENTS AND REPAIRS SHOULD BE ATTEMPTED ONLY
BY QUALIFIED ELECTRONIC TECHNICIANS.**

GATE OF DOOM™

UPRIGHT GAME

1. C. REPLACEMENT PARTS LISTS

The following lists indicate the major replaceable parts for your GATE OF DOOM™ Upright Game, Control Panel Assembly, Service Panel Assembly and Drawer Assembly. When ordering replacement parts, please be sure to provide both the complete description and part number.

P/N 500-0054-00 Upright Game

<u>Part Number</u>	<u>Description</u>	<u>Remarks</u>
031-0007-00	Speaker, 5" X 7", 16Ω	
365-0020-25	Cabinet Assy, 1US49-style, (25")	gray (45 deg)
380-0005-01	Bezel, Monitor, black	
510-0159-01	Drawer Assembly	5v-11a, 12v-1a
510-0004-00	Coin Door Assy, 2 slot	
510-0190-00	Monitor, 25" Universal H/V	
510-0189-00	PCB Set, GATE OF DOOM	
510-0191-00	Control Panel Assy, GATE OF DOOM	
515-0029-02	Panel Assy, Service	
535-0145-00	Retainer, Plex, Marquee	
660-0001-09	Plex, Clear, 23.75 X 7.8 X .125 (for marquee)	
780-0173-00	Manual, Service & Operation, GATE OF DOOM	
810-0045-25	Underlay, Monitor, GATE OF DOOM-25"	
820-0054-00	Decal, Side, GATE OF DOOM	
800-0047-00	Overlay, Marquee, GATE OF DOOM (for marquee plex)	

GATE OF DOOM™

UPRIGHT GAME

1. C. REPLACEMENT PARTS LISTS (continued)

P/N 510-0191-00 Control Panel Assembly
--

<u>Part Number</u>	<u>Description</u>
180-0024-00	Pushbutton Assy, w/microswitch, Black
180-0024-02	Pushbutton Assy, w/microswitch, Red
180-0024-06	Pushbutton Assy, w/microswitch, Blue
406-0180-24	Tag, Pushbutton ID, "Player 1"
406-0180-25	Tag, Pushbutton ID, "Player 2"
406-0180-16	Tag, Pushbutton ID, "Attack"
406-0180-26	Tag, Pushbutton ID, "Magic"
450-0015-01	Joystick, 8 way
535-0061-00	Control Panel, Bare
800-0030-00	Overlay, Control Panel, GENERIC

P/N 515-0029-02 SERVICE PANEL ASSEMBLY
--

<u>Part Number</u>	<u>Description</u>	<u>Comments</u>
090-0002-00	Coin Counter, 12 volt	w/internal diode
123-0008-11	Potentiometer, 100 Ω , 4 watt	Volume Control
180-0024-xx	Pushbutton Assy, w/Micro switch	(any color will do)
535-0084-00	Bracket, Service Panel	

P/N 510-0159-02 DRAWER ASSEMBLY

<u>Part Number</u>	<u>Description</u>	<u>Comments</u>
001-0012-00	Switching Regulator	+5 V @ 11A, 12V @ 2A
010-0001-00	Transformer, Isolation	1 A (min) @ 115 VAC
036-0186-02	Harness, Main, JAMMA STD	
150-0006-00	Filter, Noise	Delta # 10DKAG5
200-0002-00	Fuse, 1 A Fast Blow	for Coin Door Lamps
200-0011-00	Fuse, 3 A Slo Blow	115 VAC Line Fuse
205-0003-02	Fuse Block, 2 position	
366-0004-00	Shelf, wood	
034-0001-00	Power Cord	
660-0003-00	Fish Paper	(safety cover)

GATE OF DOOM™ CONVERSION KIT

2. A. SPECIFIC REQUIREMENTS

Thank you for purchasing a DATA EAST game. We hope that it will give you many years of productive enjoyment. Your GATE OF DOOM™ game conversion kit is intended to be installed into an existing video game cabinet, and comes with all the necessary components to make the converted unit look and play like a new, dedicated game.

THE GAME TO BE CONVERTED MUST MEET THE FOLLOWING REQUIREMENTS

MONITOR: Horizontal, RGB, Negative Composit Sync Input

POWER SUPPLY: + 5VDC @ 10 amp, +12VDC @ 1 amp

2. B. REPLACEMENT PARTS LIST

The following items are provided with your GATE OF DOOM™ generic kit. When ordering replacement parts, please be sure to provide the complete description and part number.

Part Number	Description	Remarks
036-0158-02	Hrns, JAMMA - GENERIC KIT	
180-0024-00	Pushbutton Assy, w/microsw, Black	
180-0024-02	Pushbutton Assy, w/microsw, Red	
180-0024-06	Pushbutton Assy, w/microsw, Blue	
406-0003-00	Label, FCC Warning	
406-0180-24	Tag, Pushbutton ID, "Player 1"	
406-0180-25	Tag, Pushbutton ID, "Player 2"	
406-0180-16	Tag, Pushbutton ID, "ATTACK"	
406-0180-26	Tag, Pushbutton ID, "MAGIC"	
450-0015-51	Joystick, 8 way	
510-0189-00	PCB set, GATE OF DOOM	
660-0001-08	Plex, Clear, 26 1/16 X 9 X .125	(for marquee)
780-0173-00	Manual, Inst., GATE OF DOOM	
800-0030-00	Overlay, Ctrl Pnl, Generic	blue DATA EAST
810-0045-03	Underlay, Monitor, GATE OF DOOM	
820-0054-00	Decal, Side, GATE OF DOOM	
800-0047-00	Overlay, Marquee, GATE OF DOOM	

GATE OF DOOM™ CONVERSION KIT

2. C. INSTALLATION INSTRUCTIONS

When selecting a game to convert, make sure that the Power Supply, the Monitor, and the Coin Acceptors are functional. There is nothing more frustrating than installing a conversion kit and having it not operate due to a faulty monitor or power supply. You should not expect the new logic PCB to be defective. It has been thoroughly tested and 'burned-in' at the factory.

It is mandatory that the cabinet be wired to conform with all National and Local electric codes before the conversion is attempted. The primary power input section must have adequate noise filtering on the AC line to prevent undesirable conducted radio frequency interference (RFI). "Adequate" is defined as a filter with both common mode and differential mode filtering and a minimum current capacity of 2.5 Amp.

The Federal Communications Commission (FCC), and other regulatory agencies, require that every video game be clearly labeled with the Name and Address of the Original Manufacturer, Date of Manufacture (or Serial Number), Power requirements, Suitability for indoor or outdoor use, and the Model number of the unit. **DO NOT DESTROY OR DEFACE THE ORIGINAL GAME ID TAG.** In addition, the FCC requires that, after conversion, the unit must be labeled with a suitable warning stating that radio frequency interference may result from use in a residential area. An acceptable label is included with this kit.

**IT IS THE RESPONSIBILITY OF THE PERSON INSTALLING
THIS KIT TO COMPLY WITH ALL LABELING REQUIREMENTS!**

2. C. 1. TAKING IT APART

Performing a few simple tasks when preparing a game to be converted can save you much time and effort when you are installing the conversion kit.

Find the Wiring Diagram of the game to be converted. You will need to identify the required DC power supply output wires and the monitor video and sync wires. Note the color coding of these wires, or better yet, label them as to their function. This kit contains a new Main Harness, but you will need to splice it into the existing power supply and video wiring.

Remove the existing game harness parts that will not be used in this conversion. **NOTE:** You are modifying only the secondary (DC from power supply) and I/O (video, speaker, and controls) sections of the wiring. **DO NOT MODIFY OR REMOVE THE PRIMARY AC WIRING.** The original manufacturer should have designed and built it to comply with Local and National Electrical Codes and FCC regulations. It must not be altered.

GATE OF DOOM™ CONVERSION KIT

2. C. 1. *TAKING IT APART (continued)*

Remove the original game pcb from the cabinet. Remove all exterior decals, and repair any cabinet damage. Repaint the cabinet if necessary. Remove the monitor plex (or glass). If your plex has silkscreened art work on it, you will need to strip it off, or replace it with a new piece cut to the same size. Using the old Monitor Plex as a template, cut the Monitor Underlay card, supplied with this kit, to the same size as the old plex. NOTE: Be certain that the opening in the Underlay Card lines up with the monitor screen.

Remove the Marquee Plex from the game and use it as a template to cut the new Marquee Plex down to the correct size. Remove the control panel from the game and remove all controls and graphics from it. Drill and/or punch any required new holes for the control panel. GATE OF DOOM™ is a one or two player game, and requires two joy sticks. The game requires two "ATTACK", and two "MAGIC" buttons, although it is recommended that four of each be installed (to allow the player to attack either left handed or right handed). See the diagram below for a suggested control panel layout. If you are going to cover the control panel with clear plex, you should carefully cut it to fit the control panel at this time. Thoroughly clean the control panel so that the new control panel overlay will adhere to it aggressively.

2. C. 2. *PUTTING IT TOGETHER*

Install the Control Panel Overlay by peeling off the paper backing and carefully laying the overlay down on the panel. Smooth it out starting in the center and working your way out to the edges, removing all of the trapped air pockets. If possible, cut the edges of the overlay oversize and fold the excess under the panel. Cut out the button and joy stick holes. Install the BUTTON ID labels supplied with the kit.

FIGURE 1 - Suggested Control Panel Layout

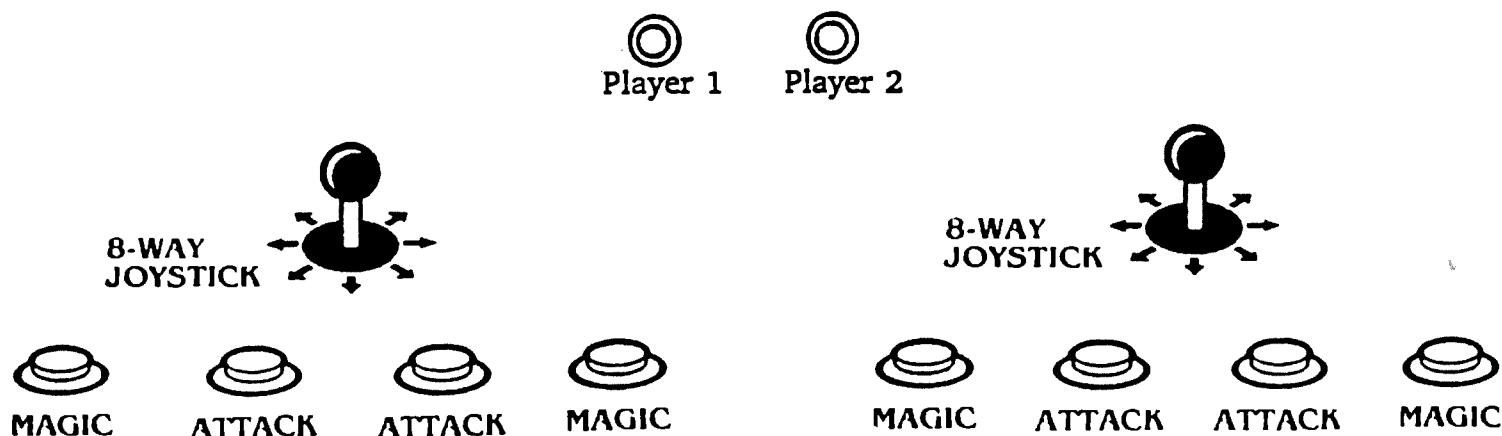

GATE OF DOOM™ CONVERSION KIT

2. C. 2. *PUTTING IT TOGETHER (continued)*

You may wish to cover the control panel overlay and button ID labels with clear plex at this time. Install the new buttons and joy stick at this time. Refer to Figure 1 on the previous page for recommended control layout.

GAME PCB: Mount the Game PCB in a convenient location in the cabinet, using the mounting feet and hardware supplied with the pcb.

MAIN HARNESS: The generic, main harness provided with this kit has a standard, 56 pin JAMMA connector. RFI filtering is incorporated on the PC Board. This filtering is intended to help prevent high frequency signals from being radiated via the cabinet wiring. However, If your converted game causes harmful radio frequency interference, you will be required, at your own expense, to add additional, external filtering, or take whatever steps may be necessary to eliminate the unwanted interference. The Game pcb has a 56 pin, JAMMA connector. Refer to Table 1, on page 12 for information pertaining to signals and functions as they are found on the game pcb edge connector.

POWER SUPPLY WIRING: Separate the DC power wires and route them through the cabinet to the Power Supply. Try to keep the length of these wires to a minimum for best results.

NOTE: USE A MINIMUM OF TWO (2) WIRES EACH FOR THE +5 VOLTS AND THE GROUND LINES BETWEEN THE POWER SUPPLY AND THE PCB. Terminate these wires at the power supply as required.

NOTE: IMPROPER WIRING WILL DAMAGE THE PCB SET AND VOID THE WARRANTY!

PLAYER CONTROL WIRING: Route the push button and joy stick wires up to their proper destinations, cut to length, and terminate as required.

MONITOR WIRING: The game outputs are Positive for the Red, Green and Blue signals, and Negative Composite Sync. If your monitor has separate Horizontal and Vertical sync inputs, hook the Composite sync to the negative Horizontal input. This method will work on most monitors. However, some Electrohome models require that the Composite sync signal be hooked up to both the negative Horizontal and Vertical inputs. Contact your distributor for more information if you are uncertain as to how to hook up the monitor wires.

COIN DOOR: The coin counter(s) may be the 12 volt or the 6 volt type, as the game pcb utilizes an open collector drive circuit. Hook one coin counter wire to the required, positive voltage and the other wire to the coin counter signal wire from the main harness edge connector. Refer to the standard connection diagrams on page 12.

GATE OF DOOM™ CONVERSION KIT

2. C. 2. *PUTTING IT TOGETHER (continued)*

GRAPHICS: The monitor underlay card is pre-printed with game instructions. Carefully trim it, as necessary to fit your cabinet. Install the underlay card under a clean, clear plex or glass. Check any marquee lamps for proper operation. Replace any burned out lamps. The GATE OF DOOM™ marquee overlay must be installed on a piece of clear plex. Before you do that, use the old plex as a guide for cutting the 26 x 9" clear plex (provided with this kit) to the proper size. Next, remove the protective coverings from the clear plex, and carefully clean it with a good, anti-static cleaner to remove any and all specks of dust, etc, that may have been attracted to it. Then remove the paper backing from the marquee overlay, and affix the overlay to the clear marquee plex. Make sure that the copyright notice will not be hidden by any plex retainers when installed. Smooth out any and all bubbles. Install the two GATE OF DOOM side decals.

IMPORTANT! Install the "FCC Warning" label to the upper rear of the cabinet.

THE BIG TEST!

Remove the Main Harness connector from the game pcb. Apply power. Measure the +5 volts at the edge connector of Main Harness (at the point where it would connect to the game pcb). Adjust to +5.15 VDC using a Digital volt meter. Measure the +12 volts and the -5 volts (if any) to ensure that they are connected properly and are on the correct terminals. **TURN THE POWER OFF!** Now reconnect the Main Harness connector to the game pcb, and apply power once again. The attract mode video should appear on the screen. Adjust the picture size and colors on the monitor to get the optimum appearance. Adjust the Sync and Hold controls on the monitor for a stable picture. Coin it up and give it a try! Test all the controls and check the sound for proper operation.

CONGRATULATIONS! You have successfully installed your DATA EAST conversion kit. We hope that it gives you many years of successful operation.

GATE OF DOOM™











UPRIGHT GAME & CONVERSION KIT











3. A. GAME PLAY INSTRUCTIONS

- * Press PLAYER 1 or PLAYER 2 button.
- * Choose the KNIGHT, WIZARD, BARD, or NINJA.

YOUR QUEST: Battle your way to the chamber of evil and close the Gate of Doom, thereby saving the kingdom of Etrulia.

MAGIC Button: Destroy enemies to increase magic power. When magic power is at maximum, select your spell from pictures in spellbook and press MAGIC button to cast spell.

POWER-UP ITEMS		
	PROTECTION FROM FIRE	
	PROTECTION FROM COLD	
	NEUTRALIZE CONFUSION, POISON	
	INCREASE SPEED	
	ATTACKING POWER	
	DEFENDS AGAINST 3 ATTACKS	
		
		HEALING
		DESTROYS ALL ENEMIES
		SCORE BONUS
		SPELL METER MAXIMIZED

MAGIC SPELLS		
	FIRE ELEMENTAL	
	MAGIC PLANT (POISONOUS SPORES)	
	WATER ELEMENTAL	
	MEDUSA	
	THUNDER AND LIGHTNING	
		
		BOULDER (CAUSES EARTH-QUAKES)
		LIGHT ELEMENTAL
		RAT PACK
		
		TORNADO
		
		IRON BALL
		
		MYSTERY SPELL

GATE OF DOOM™

UPRIGHT GAME & CONVERSION KIT

3. A. OPERATOR SELECTABLE OPTIONS

The GATE OF DOOM™ game allows for operator adjustable pricing, number of lives, difficulty, etc. These are accessed by the two 8 position dipswitches located on the main logic pcb. Tables 1 and 2 outline the available options.

TABLE 1 - Dipswitch 1

		1	2	3	4	5	6	7	8
Game Charge (Right) COIN 1	1 coin = 1 credit	OFF	OFF	OFF					S A L W A Y S
	1 coin = 2 credit	ON	OFF	OFF					
	1 coin = 3 credit	OFF	ON	OFF					
	1 coin = 4 credit	ON	ON	OFF					
	1 coin = 5 credit	OFF	OFF	ON					
	1 coin = 6 credit	ON	OFF	ON					
	2 coin = 1 credit 3 coin = 1 credit	OFF ON	ON ON	ON					
Game Charge (Left) COIN 2	1 coin = 1 credit				OFF	OFF	OFF		O F F
	1 coin = 2 credit				ON	OFF	OFF		
	1 coin = 3 credit				OFF	ON	OFF		
	1 coin = 4 credit				ON	ON	OFF		
	1 coin = 5 credit				OFF	OFF	ON		
	1 coin = 6 credit				ON	OFF	ON		
	2 coin = 1 credit 3 coin = 1 credit				OFF ON	ON ON	ON		
Flip Screen?	Normal: Flip:							ON OFF	

TABLE 2 - Dipswitch 2

		1	2	3	4	5	6	7	8
Number of lives	3 Lives:	OFF	OFF						
	4 Lives:	ON	OFF						
	2 Lives:	OFF	ON						
	1 Lives:	ON	ON						
Game Difficulty	Normal:			OFF	OFF				
	Easy:			ON	OFF				
	Hard:			OFF	ON				
	Hardest			ON	ON				
Life Indicator	3 Lives:					OFF	OFF		
	4 Lives:					ON	OFF		
	2.5 Lives:					OFF	ON		
	2 Lives:					ON	ON		
Continuation mode?	YES: NO:							ON OFF	
Attract Mode Sound?	YES: NO:							ON OFF	

GATE OF DOOM™
UPRIGHT GAME & CONVERSION KIT

3. B. PCB EDGE CONNECTOR PIN-OUTS

TABLE 1 - JAMMA Connector

Wire Color	Solder Side Signal	Pin No.	Pin No.	Parts Side Signal	Wire Color
BK	GROUND	A1	B1	GROUND	BK
BK	GROUND	A2	B2	GROUND	BK
RD	+5 VOLTS	A3	B3	+5 VOLTS	RD
RD	+5 VOLTS	A4	B4	+5 VOLTS	RD
BU	-5 VOLTS	A5	B5	-5 VOLTS	BU
OR	+12 VOLTS	A6	B6	+12 VOLTS	OR
VI	BLOCKING KEY COIN COUNTER #2	A7 A8	B7 B8	BLOCKING KEY COIN COUNTER #1	SL
WH/BK	SPEAKER(-)	A9 A10 A11	B9 B10 B11	SPEAKER (+)	BK/WH
GN	VIDEO - GREEN	A12	B12	VIDEO - RED	RD
WH	VIDEO - SYNC	A13	B13	VIDEO - BLUE	BU
YL	SERVICE SWITCH	A14	B14	VIDEO GROUND	BK
RD	COIN SWITCH #2	A15	B15	TEST SWITCH	BK/GN
RD/WH	Player 2 START	A16	B16	COIN SWITCH #1	GN
YL/WH	2 P UP	A17	B17	Player 1 START	BN/WH
GN/WH	2 P DOWN	A18	B18	1 P UP	YL
OR/WH	2 P LEFT	A19	B19	1 P DOWN	GN
RD/WH	2 P RIGHT	A20	B20	1 P LEFT	OR
BL/WH	2 P ATTACK	A21	B21	1 P RIGHT	RD
VI/WH	2 P MAGIC	A22	B22	1 P ATTACK	BL
PK/WH	NOT USED	A23	B23	1 P MAGIC	VI
		A24	B24	NOT USED	PK
		A25	B25		
		A26	B26		
BK	GROUND	A27	B27	GROUND	BK
BK	GROUND	A28	B28	GROUND	BK

GATE OF DOOM™ UPRIGHT GAME & CONVERSION KIT

3. C. STANDARD CONNECTION DIAGRAMS

FIGURE 1 - Coin Counters & Coin Switches

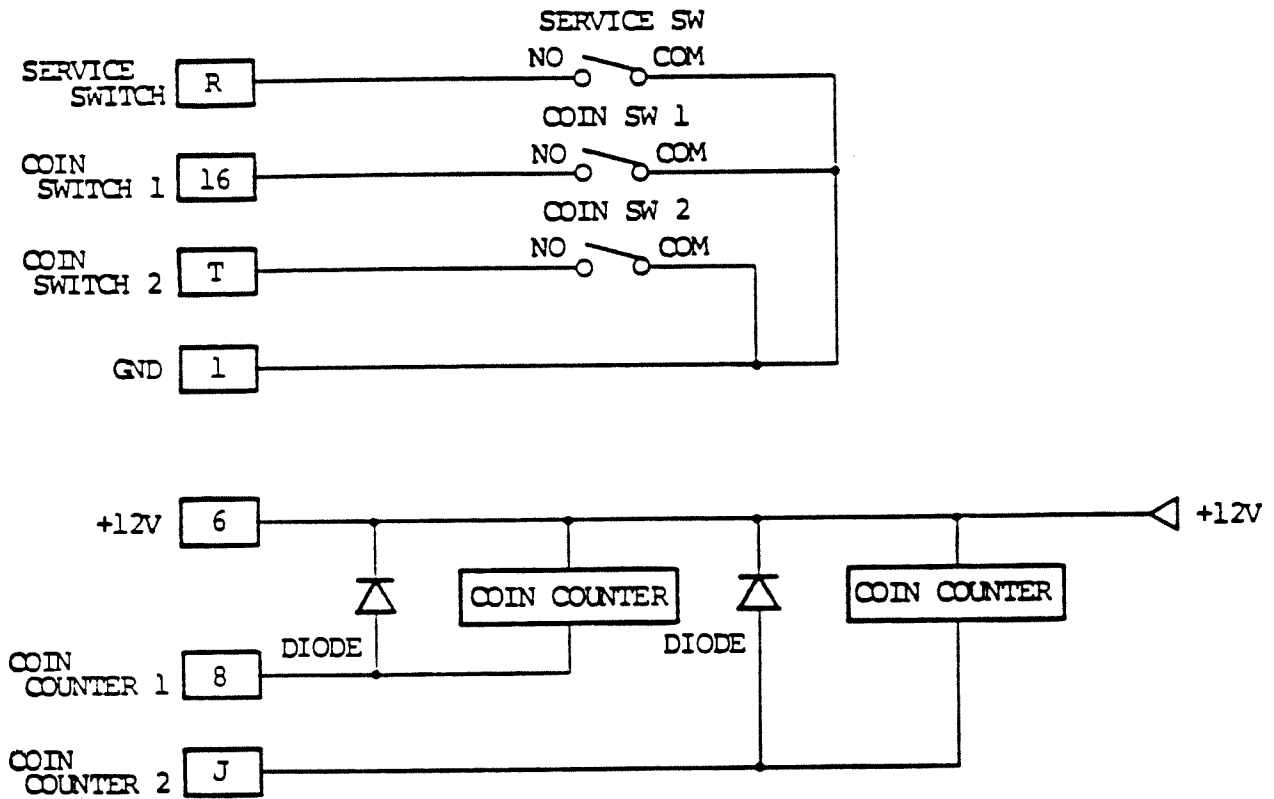
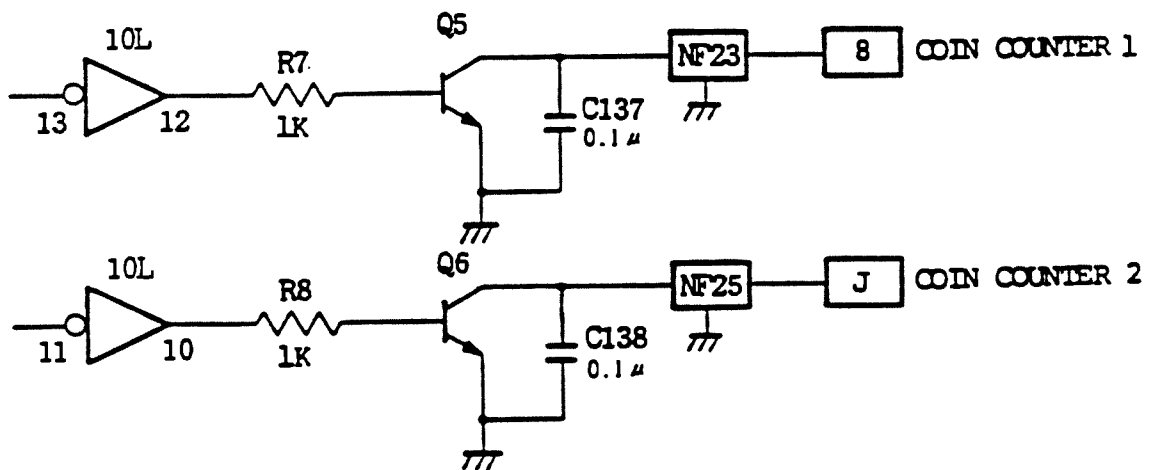

FIGURE 2 - Coin Counter/Coin Switch Circuit



GATE OF DOOM™
UPRIGHT GAME & CONVERSION KIT

4. 0. CUSTOMER RESPONSE CARD

This GATE OF DOOM™ Installation and Service Manual does not include schematic diagrams. However, it should answer most of the technical questions that you may have. Should you require additional, or more detailed information, you should contact the DATA EAST distributor from whom you have purchased the game. His highly qualified staff will, most likely, be able to answer your questions, or give you the proper direction. If, after consulting with your distributor, you still require additional assistance, you may contact the DATA EAST service department at (408) 286-7080, between the hours of 8:00 AM and 5:00 PM Pacific time. When contacting your distributor, or when contacting DATA EAST, please be prepared to provide the serial numbers for the game pcb (printed on the original product seal), the "AAMA PROTECT" sticker, and the game cabinet.

DATA EAST welcomes all constructive feedback, both negative and positive. We would be pleased if you would write us directly with your comments concerning our products and services. Our address is:

DATA EAST USA, INC.
1850 Little Orchard Street
San Jose, CA 95125

GATE OF DOOM™ CUSTOMER RESPONSE CARD

COMPANY NAME: _____

ADDRESS: _____

CITY: _____ STATE: _____ ZIP: _____

TELEPHONE: _____

YOUR NAME: _____ TITLE: _____

GAME CABINET SERIAL NUMBER _____

PCB SERIAL NUMBER _____ AAMA # _____

(from Original Product Seal)

ADD YOUR COMPANY TO OUR DIRECT MAIL LIST? (circle one) YES NO

COMMENTS: _____

WARRANTY INFORMATION

DATA EAST USA, INC., ("Seller"), warrants to the original purchaser ("Buyer"), of its products that the items listed below are free from defects in material and workmanship under normal use and service for the period specified:

GAME LOGIC PRINTED CIRCUIT BOARD(S)

90 DAYS

No other parts of the Seller's products are warranted.

Warranty periods are effective from date of initial shipment from Seller to Buyer. Seller's sole liability shall be, at its option, to repair or replace products which are returned to Seller during the warranty period specified, provided:

1. Seller is notified promptly upon discovery by buyer that stated products are defective.
2. Buyer obtains a valid return material authorization (RMA) number from Seller.
3. Such products are properly packaged and then returned freight pre-paid, to a place specified by Seller

This warranty does not apply to products damaged during shipment and/or due to improper handling, or due to improper installation or usage, or alteration. In no event shall Seller be liable for any anticipated profits, loss of profits, loss of use, accidental or consequential damages, or any other losses incurred by the customer in connection with the purchase of a Data East USA, Inc. product.

Except as specifically provided in a written contract between seller and buyer, there are no other warranties, expressed or implied, including any implied warranties of merchantability or fitness for a particular purpose.