

TM

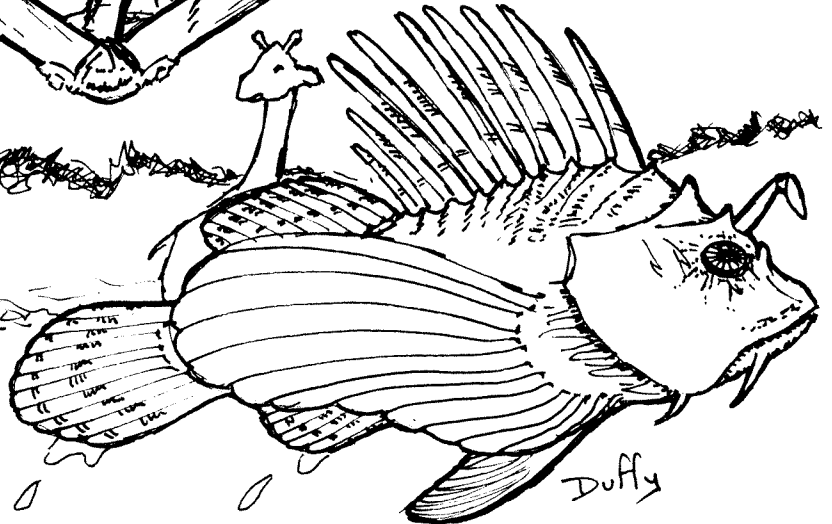
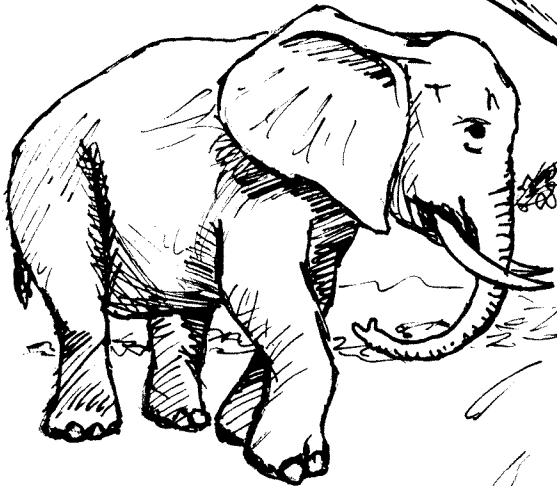

# installation manual

# TAITO<sup>TM</sup>

TAITO AMERICA CORPORATION  
390 Holbrook Drive  
Wheeling, IL 60090

Telephone (708) 520-9280  
Fax (708) 520-1309

PART NO. 352-200701



# TABLE OF CONTENTS

SECTION	PAGE
General Information . . . . .	1
Game Preparation . . . . .	2
Conversion Instructions . . . . .	2 – 3
Game Description . . . . .	4
Cabinet Styles . . . . .	5
Connector Locations . . . . .	6
Dip Switch Settings . . . . .	7
Control Panel Layouts . . . . .	8
Connection Charts . . . . .	10
Parts List . . . . .	11

---

\* ATTENTION \*

THE COPYRIGHTED VIDEO GAME THAT ACCOMPANIES THIS MANUAL CARRIES WITH IT A ROYALTY FREE, NON-EXCLUSIVE LICENSE FROM THE COPYRIGHT OWNER TO THE OWNER OF THE VIDEO GAME TO PUBLICLY PERFORM THE COPYRIGHTED VIDEO GAME IN THE UNITED STATES OF AMERICA, CANADA, AND MEXICO. THIS PUBLIC PERFORMANCE LISCENSE ATTACHES AND APPLIES ONLY TO THE PHYSICAL EMBODIMENT OF THE VIDEO GAME THAT ACCOMPANIES THIS MANUAL. THIS PUBLIC PERFORMANCE LISCENSE MAY ONLY BE TRANSFERRED TO THE SUBSEQUENT OWNER(S) OF THE PHYSICAL EMBODIMENT OF THE VIDEO GAME THAT ACCOMPANIES THIS MANUAL.

# GENERAL INFORMATION

This manual will guide you in the conversion of your color monitor upright video game into a Grawl game. We strongly urge you to read through the instructions carefully before beginning the conversion.

## WARNINGS AND NOTICES

For safety and reliability, Taito America Corporation does not recommend nor authorize any substitute parts or modifications of Taito America Corporation equipment. In addition, any substitute parts or equipment modifications may void FCC compliance.

Use of non-Taito America parts and/or modifications of game circuitry may adversely affect game performance and safety.

Since Grawl is protected by federal copyright, trademark and patent laws, unauthorized altered versions of this game are illegal under Federal law. This also applies to unauthorized facsimiles of Taito America equipment, logos, designs, publications, assemblies and/or games (or features not deemed to be in the public domain) whether manufactured with Taito America components or not.

## NOTICE

Certain parts salvaged from your old game are required to complete your kit. These salvaged parts MUST operate properly to insure the performance and safety level of this game. Always repair electronics malfunctions and cabinet damage before conversion is attempted.

Be sure the power supply from your old game is capable of delivering +5 vdc at 7 amps, -5vdc at 1A, and +12vdc at 1A. These operating voltages must be regulated and are necessary for your kit. Please note the enclosed warning with the PC board assembly.

Check the parts supplied in this kit against the parts list included in this manual.

This kit is not intended for use with X-Y (vector) monitors. Suitable monitors are horizontal raster-scan RGB types with composite negative sync. The monitor must be connected to the A.C. line through an isolation transformer.

## CAUTION

FOR SAFE OPERATION IT IS STRONGLY RECOMMENDED THAT THE CABINET BE PROPERLY GROUNDED. IF YOUR GAME IS EQUIPPED WITH A THREE CONDUCTOR POWER CABLE, THE THIRD PRONG (round) SHOULD AUTOMATICALLY GROUND THE GAME WHEN PLUGGED INTO A PROPERLY GROUNDED THREE PRONG RECEPTACLE. IF IT BECOMES NECESSARY TO USE AN ADAPTER, THE GROUNDING LUG OR WIRE ON THE ADAPTER MUST BE PROPERLY GROUNDED TO ASSURE SAFE OPERATION.

# GAME PREPARATION

All games require a certain amount of maintenance to remain in good operating condition. A periodic check of mechanical controls would be beneficial to guarantee the profitability of your game.

## CLEANING

The exterior of the game, all metal parts and all plastic parts can be cleaned with a non-abrasive cleaner. Caution should be used when cleaning the plastic. A dry cloth can cause scratches and result in a foggy, worn appearance. Plexiglass cleaner on a soft cloth is suggested to keep your monitor crt cover looking new.

Inspect your cabinet for any gouges or items stuck on the cabinet (like chewing gum). Remove all foreign objects and fill in the gouges with any type of quick-hardening wood putty. Sand to ensure a smooth surface. Wipe the outside of the old cabinet clean. Remember that the reason you are converting your old game is to have the increased earnings of a new game, and making your game LOOK new helps spark player interest.

Please make sure you clean the coin mechanisms. It is important that you service them in order for this game to achieve the maximum possible earnings.

# CONVERSION INSTRUCTIONS

## GAME TITLE MARQUEE

Remove the new Grawl marquee from the kit. This marquee is specifically designed for ease of handling. Place and center the old marquee on top of the new marquee. Border the area that you intend to cut with masking tape. Using an X-Acto or similar knife, score the new marquee and simply break at this score. If your old marquee is made of glass, remove the paint of the old marquee and attach the new marquee behind this glass. If your old marquee is made of Plexiglass, it is recommended that a new, clear plexiglass panel be used to show the Grawl marquee sharply.

## MONITOR BEZEL

Remove the new Grawl monitor bezel from the kit. Place the bezel around the existing monitor. Using an X-Acto or utility knife, trim the new monitor bezel to neatly fit around the monitor.

## CONTROL PANEL

Remove the old control panel buttons, joystick(s) and panel overlay. Refer to the final page of this manual for the preferred positions for the joysticks, buttons and button labels.

Leave your 1 and 2 player start buttons where they are on the old control panel. Drill holes as needed for the installation of the joysticks and buttons. Clean any burrs from around holes. Any hole that is no longer needed we suggest plugging with wood putty or epoxy.

Cut the new Growl Lexan panel overlay to the approximate size needed to cover the panel. Leave enough to wrap a small lip around the top and bottom of the panel. Remove the backing from the Growl overlay and apply it over the old control panel, being careful to avoid air pockets.

After the Lexan overlay is securely applied, cut through to the holes in the control panel with an X-Acto or utility knife. Install the joystick, buttons, button labels and any necessary hardware previously removed from the control panel. Tighten and secure all hardware.

### INSTALLING WIRING HARNESS

This game comes with a color-coded cable for easy installation. Refer to the connection diagram included in this manual for quick hook-up.

Disconnect the old wiring harness from the old cpu board and carefully remove the old EMI shields and circuit boards from the game.

Using the wiring diagrams from your old game, carefully note the function of each wire. Cut the wires near the game's coin door, monitor, control panel, power supply and speaker, leaving several inches of wire hanging from each point. Install the new wiring harness to those points referring to the connector diagram. For best results, solder directly to the lugs at the connection points and remove old wiring completely. Use electrical tape or heat-shrink tubing (preferred) to insulate any necessary wire splices. It is recommended that any wire splices be soldered; while an unsoldered twisted connection will work initially, non-conductive oxides will form on the wires that may cause failure of the junction.

Install the RFI "cage" (for FCC compliance) where the old board set was. Mount the Growl pcb assembly with the mounting blocks in the center of the RFI cage. Plug the wiring harness onto the pcb and close the cage securely. To complete proper installation, run a ground termination lead from any available chassis ground to the foil side of the RFI cage.

Check and clean the input jack on the power supply board. Replace any burned or damaged pins.





#### NOTE:

Be sure the power supply from your old game is capable of delivering +5 vdc at 7 amps and +12 vdc at 1 amp. These are the operating voltages and must be regulated and are necessary for your kit. Please note the enclosed warning with the PC board assembly.

## GAME DESCRIPTION

"Growl" casts the player as a ranger protecting endangered wild animals. A group of evil poachers are recklessly hunting the animals to extinction, so the government has hand-picked a few men to stop them. These men are empowered to use any means necessary to stop the poachers.

Each player character has it's strengths and weaknesses, unique, categorized, borrowing from the conventions of role-playing games. The character types are color coded as follows:

PLAYER	COLOR	STRENGTH	ATTACK	JUMP
1 	WHITE	AVERAGE	AVERAGE	HIGH
2 	RED	HIGH	MODERATE	AVERAGE
3 	BLUE	HIGH	MODERATE	HIGH
4 	YELLOW	MODERATE	INTENSE	AVERAGE

This game represents a departure from the convention of using specific button and joystick combinations to select individual attack styles. The game computer selects the optimal attack strategy with each press of the attack button. The player can still direct the computer to use more powerful fighting techniques by pressing both buttons simultaneously, but this will also discard weapons. Weapons are gathered by stooping down (with the joystick) and pressing the attack button. There are over a dozen different weapons, from sticks and stones to rocket launchers. Animals will follow you around and help you when you save them from the poachers.

"Growl" will work with two to four players. There is a buy-in feature that may be disabled (via dip-switch settings) on the final round.

# CABINET STYLES

The "Growl" kit may be installed in a number of different cabinet styles. The dip switch settings shown on this page configure the board to the cabinet and control panel type. A complete list of dip switch functions and settings follows.

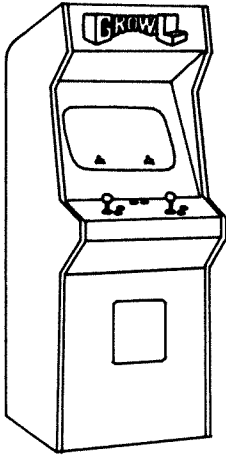

SINGLE UPRIGHT, DUAL CONTROL

DIP SWITCH B

#6	#7
OFF	OFF

4-SLOT UPRIGHT OR TWIN CABINET

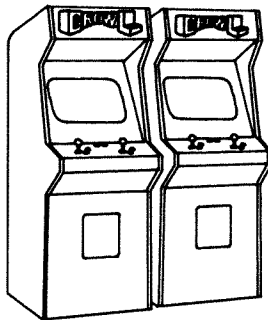
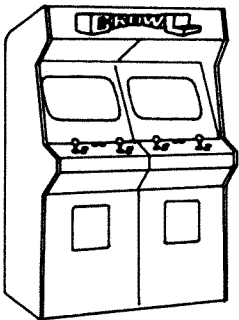

DIP SWITCH B

#6	#7
ON	OFF

NOTE: a separate kit is available for connecting to adjacent game.

2-SLOT, 4-PLAYER CABINET

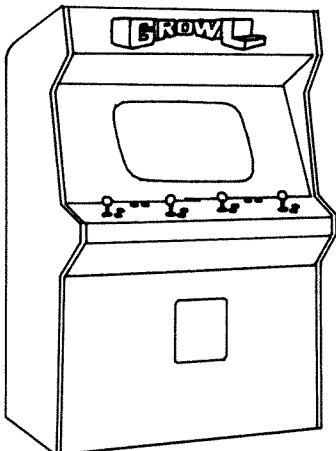

DIP SWITCH B

#6	#7
OFF	ON

# CONNECTOR LOCATIONS

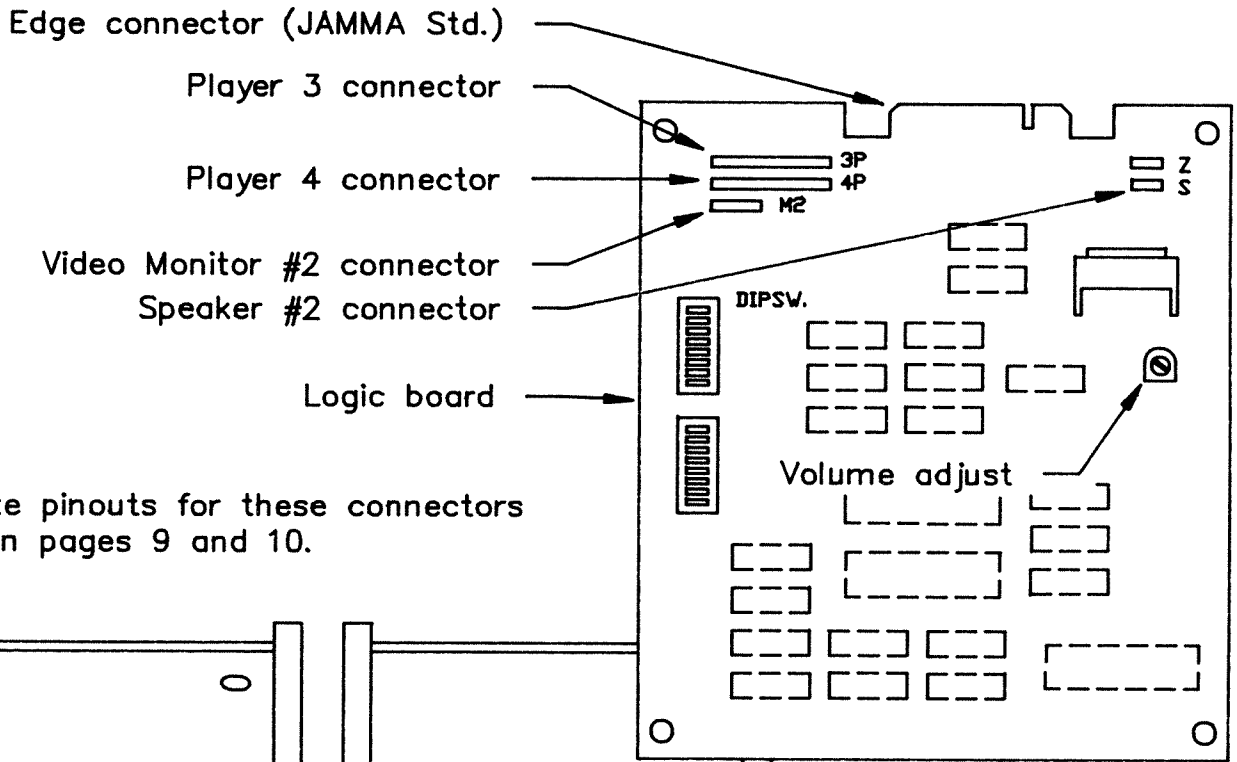

Complete pinouts for these connectors follow on pages 9 and 10.

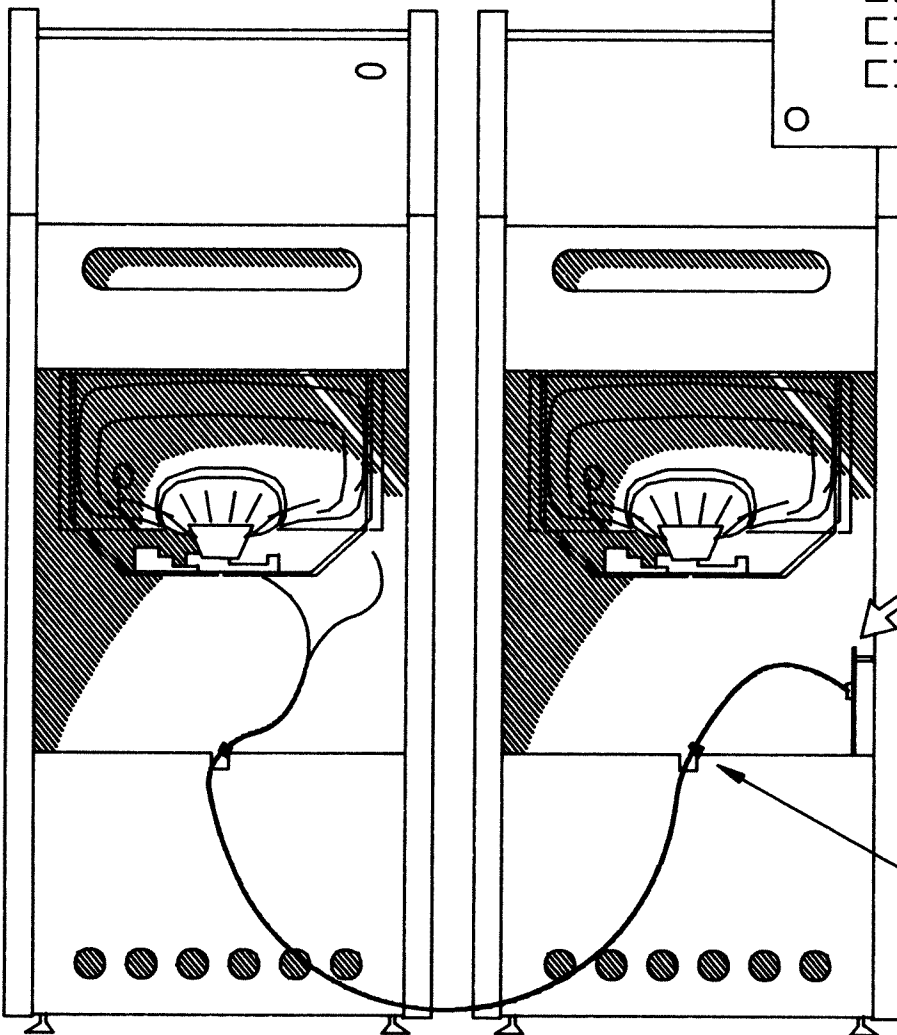

Note: When using the two-cabinet expander kit, please knot the cable inside the door slot as a strain relief.



# DIP SWITCH SETTINGS

DIP SWITCH – A:									
		SWITCH POSITIONS							
FUNCTIONS	SETTINGS	1	2	3	4	5	6	7	8
ALWAYS OFF		<b>OFF</b>							
SCREEN ROTATION	NORMAL		<b>OFF</b>						
	REVERSE		ON						
TEST MODE	NORMAL GAME			<b>OFF</b>					
	TEST MODE			ON					
ATTRACT SOUNDS	WITH					<b>OFF</b>			
	WITHOUT					ON			
PLAY PRICING	1 COIN = 1 PLAY					<b>OFF</b>	<b>OFF</b>		
	2 COINS = 1 PLAY					ON	OFF		
	3 COINS = 1 PLAY					OFF	ON		
	4 COINS = 1 PLAY					ON	ON		
PRICING FOR CONTINUED PLAY	SAME AS ABOVE							<b>OFF</b>	<b>OFF</b>
	1 COIN = 1 CONT.							ON	OFF
	2 COINS = 1 CONT.							OFF	ON
	3 COINS = 1 CONT.							ON	ON

DIP SWITCH – B:									
		SWITCH POSITIONS							
FUNCTIONS	SETTINGS	1	2	3	4	5	6	7	8
DIFFICULTY LEVELS	MODERATE		<b>OFF</b>	<b>OFF</b>					
	EASY		ON	OFF					
	DIFFICULT		OFF	ON					
	VERY DIFFICULT		ON	ON					
ALWAYS OFF						<b>OFF</b>	<b>OFF</b>		
CABINET STYLE *	2 PLAYER					<b>OFF</b>	<b>OFF</b>		
	4 PLAYER, 4 COIN SLOTS					ON	OFF		
	4 PLAYER, 2 COIN SLOTS					OFF	ON		
							ON	ON	
FINAL ROUND CONTINUE	WITH							<b>OFF</b>	
	WITHOUT							ON	
ALWAYS OFF									<b>OFF</b>

\* CHECK TABLE ON PRECEEDING PAGE      **BOLD** TYPE INDICATES FACTORY SETTINGS

# PANEL LAYOUTS

Dual Player Layout

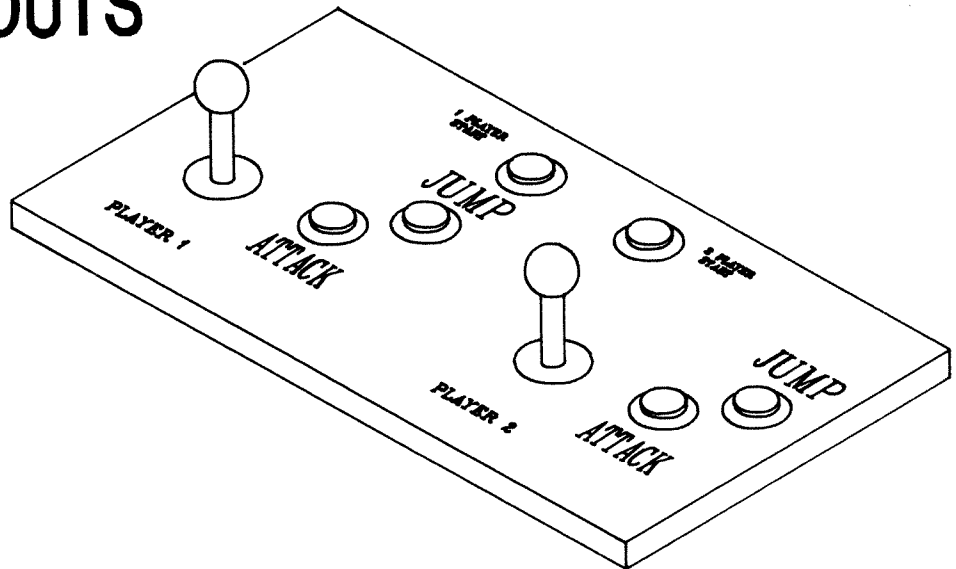

Suggested layout –  
 Recommend 4" between joystick center  
 and adjacent button, use 1.125" diameter holes  
 for button mounting, 1.375" diameter holes for joystick knob openings  
 and .25" diameter holes for the joystick mounting screws.

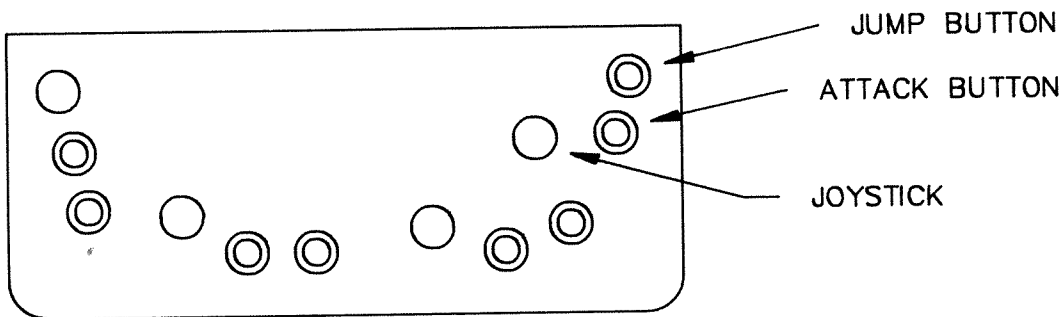

Four-Player layout

Note that game buttons can be used as start buttons. This is to ease installation in cabinets such as "Teenage Mutant Ninja Turtles"® with no start buttons.

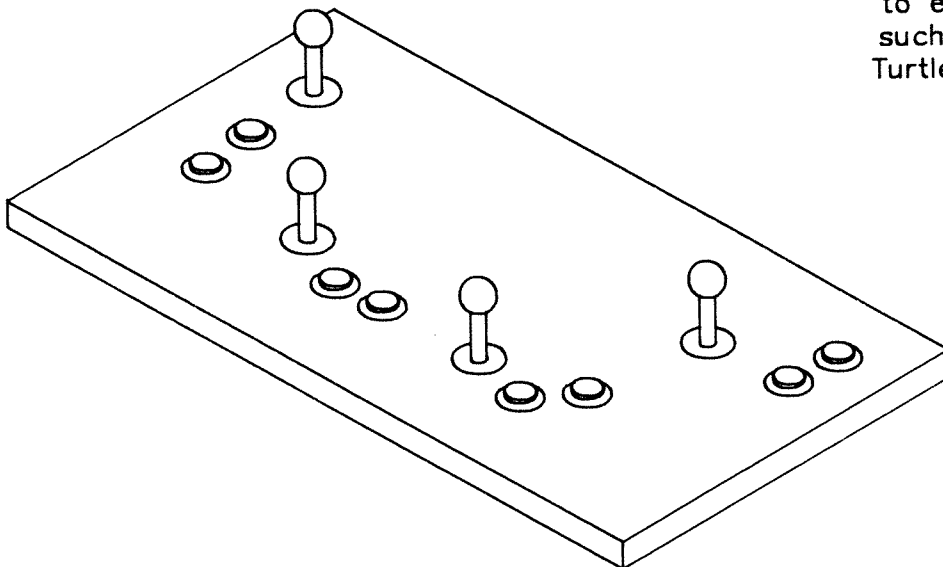

# CONNECTION CHART, MAIN HARNESS

(SOLDER SIDE)		JAMMA EDGE CONNECTOR		(COMPONENT SIDE)	
WIRE FUNCTION	COLOR			COLOR	WIRE FUNCTION
GND	BLK	A	1	BLK	GND
GND	BLK	B	2	BLK	GND
+5VDC	RED	C	3	RED	+5VDC
+5VDC	RED	D	4	RED	+5VDC
-5VDC	BRN	E	5	BRN	-5VDC
+12VDC	BLU	F	6	BLU	+12VDC
KEY		H	7	KEY	
COIN METER B	WHT/VIO	J	8	BLU/BRN	COIN METER A
COIN LOCKOUT B		K	9		COIN LOCKOUT A
SPEAKER (-)	BLK	L	10	WHT/BLK	SPEAKER (+)
VIDEO GREEN	GRN	N	12	RED	VIDEO RED
VIDEO SYNC	WHT	P	13	BLU	VIDEO BLUE
SERVICE SW.	BRN/WHT	R	14	BLK	VIDEO GND
SLAM SW.	WHT/BRN	S	15		
COIN B	GRN/YEL	T	16	WHT/YEL	COIN A
2PL SELECT	RED/BLK	U	17	PNK/BLK	1PL SELECT
2PL UP	BRN/BLU	V	18	ORN/BLU	1PL UP
2PL DOWN	ORN/WHT	W	19	GRN/ORN	1PL DOWN
2PL LEFT	ORN/GRN	X	20	GRN/BLU	1PL LEFT
2PL RIGHT	WHT/ORN	Y	21	RED/YEL	1PL RIGHT
2PL ATTACK	BRN/BLK	Z	22	RED/WHT	1PL ATTACK
2PL JUMP	YEL/WHT	Ā	23	WHT/RED	1PL JUMP
		Ḃ	24		
GND	BLK	Ē	27	BLK	GND
GND	BLK	F	28	BLK	GND

# FOUR-PLAYER OPTION WIRING

**"3P"**

	PLAYER 3	
	COLOR	FUNCTION
1	YEL/BLK	COIN 3
2	RED	3P START
3	YELLOW	3P LEFT
4	ORANGE	3P RIGHT
5	BLUE	3P UP
6	GREEN	3P DOWN
7	BROWN	3P ATTACK
8	VIOLET	3P JUMP
9	GRAY	
10	N.C.	
12	WHT/BLK	COIN METER 3
13	BLU/YEL	LOCK OUT 3
14	BLK	GND
15	BLK	GND

**"4P"**

	PLAYER 4	
	COLOR	FUNCTION
1	BRN/BLK	COIN 4
2	RED/WHT	4P START
3	YEL/WHT	4P LEFT
4	ORN/WHT	4P RIGHT
5	BLU/WHT	4P UP
6	GRN/WHT	4P DOWN
7	BRN/WHT	4P ATTACK
8	VIO/WHT	4P JUMP
9	GRY/WHT	
10	N.C.	
12	WHT/RED	COIN METER 4
13	VIO/YEL	LOCK OUT 4
14	BLK	GND
15	BLK	GND

**"M2"**

	VIDEO MONITOR #2	
	COLOR	FUNCTION
1	RED	VIDEO RED
2	GREEN	VIDEO GREEN
3	BLK	VIDEO BLUE
4	WHITE	VIDEO SYNC
5	BROWN	VIDEO GND

**"S"**

	SPEAKER #2	
	COLOR	FUNCTION
1	RED/YEL	SPEAKER (+)
2	RED/BLK	SPEAKER (-)
3	N.C.	

# PARTS LIST

Qty.	Description	Part Number
1	PCB, Game Logic	325-100001
1	Wiring Harness, JAMMA-standard	900-601001
1	Wiring Harness, four-player option	325-601001
1	RFI shield (for FCC regulations)	900-800401
1	8-way 'Ultimate' Joystick assembly - red	900-401870
1	8-way 'Ultimate' Joystick assembly - blue	900-401871
1	8-way 'Ultimate' Joystick assembly - yellow	900-401874
1	8-way 'Ultimate' Joystick assembly - black	900-401872
2	Ultimate Pushbutton, red	900-400001
2	Ultimate Pushbutton, blue	900-400003
2	Ultimate Pushbutton, yellow	900-400004
2	Ultimate Pushbutton, black	900-400006
1	Monitor bezel	325-200101
1	Marquee	325-200201
1	Control panel overlay	900-200302
1	Kit instruction manual	325-200701

## RECOMMENDED TOOL LIST

- [ ] Screwdriver, flathead
- [ ] Screwdriver, Phillips
- [ ] Pliers
- [ ] Allen wrench set
- [ ] Grease pencil or marker
- [ ] Soldering iron and solder
- [ ] Hacksaw, Jigsaw or Tablesaw  
(with carbide-tipped blade)

- [ ] Wire cutters
- [ ] Utility or X-Acto knife
- [ ] Electric drill
- [ ] 1.125" drill bit (buttons)
- [ ] 1.375" drill bit (joystick)
- [ ] .25" drill bit (joystick screws)
- [ ] Sandpaper, 180 grit
- [ ] Electrical tape or heat-shrink tubing



**TAITO AMERICA CORPORATION**

390 Holbrook Drive  
Wheeling, IL 60090  
Telephone (708) 520-9280  
Fax (708) 520-1309