

SEGA™



TWIN OWNER'S MANUAL



SEGA ENTERPRISES, INC. (USA)

Contents

	<u>Page</u>
INTRODUCTION OF THE OWNER'S MANUAL	1
PRODUCT SEALS AND SAFETY CERTIFICATION	2
HANDLING PRECAUTIONS	3
INSTALLATION AND LOCATION PRECAUTIONS	4
SPECIFICATIONS	5
INSTALLATION ITEMS	6
ASSEMBLING THE MACHINE	7
Uncrate Left-Side Cabinet (Crate #1)	7
Uncrate Right-Side Cabinet (Crate #2)	7
Uncrate Cash Box Tower and Billboard (Crate #3)	7
Prepare Cabinets and Tower for Assembly	7
Install Right-Side Cabinet	8
Install Left-Side Cabinet	8
Install Billboard	9
Adjust Leg Levers	10
Linking Left- and Right-Side Cabinets	11
Power On	12
Check Game Board Parameters	13
HOW TO PLAY	15
EXPLANATION OF TEST AND DATA DISPLAYS	17
Test Mode Scheduling	17
Service Panel	18
Test Menu	19
Memory Test	20
T.G.P. Test	21
Input Test	22
Output Test	23
Sound Test	24
C.R.T. Test (RGB Color Adjustment, Monitor Size Adjustment)	25
Game Assignments	27
Coin Assignment (Coin/Credit, Manual Setting)	29
Control Range ("Volume") Setting	33
Bookkeeping (Credits and Times, Time Histogram)	34
Backup Data Clear	37
PERIODIC CHECK	38
TROUBLESHOOTING	39
MACHINE OPTIONS	40
Linking Instructions (Assembly, Game System Settings, Playing Instructions)	40
PARTS LIST	44



Contents (cont.)

SERVICE INFORMATION	63
Billboard Lamps Replacement	63
Monitor Service	64
Underseat Cabinet Access	67
Replacing Fans and Fuses.....	69
Replacing the Underseat Speaker	69
Lubricating the Seat Rails.....	69
Drive Board DIP Switch Settings	70
Accelerator and Brake Greasing, Adjustment, and Replacement.....	71
Steering Wheel Service	73
Shift Lever Greasing and Switch Replacement	76
Button Lamp Replacement	77
WIRING DIAGRAM	79
INDY 500 TWIN MANUAL COMMENTS	83

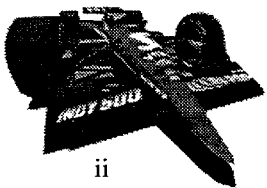

List of Figures

<u>No.</u>	<u>Figure Title</u>	<u>Page</u>
1	Indy 500 Twin Installation Dimensions	5
2	Rear View, Assembled Indy 500 Twin Cabinet	7
3	Right-Side Cabinet Installation	8
4	Left-Side Cabinet Installation	8
5	Billboard Installation Location	9
6	Billboard Installation Details	9
7	Cabinet, Bottom View	10
8	Leg Levelers, Bottom View	10
9	Leg Leveler and Caster, Side View	10
10	Joint Plate Installation	11
11	Fiber Optic Cable Connector	11
12	Two Player Linking	11
13	Power-On Check of Steering Wheel	12
14	Network Check Screens	12
15	Service Panel Controls	13
16	Course Selection	15
17	On-Screen Display Locations	15
18	Control Locations	16
19	Service Panel Controls and Indicators	18
20	Turning the Steering Wheel	33
21	Centering the Steering Wheel	33
22	Fiber Optic Cable Connector	40
23	Four Player Linking Diagram	40
24	Six Player Linking Diagram	41
25	Eight Player Linking Diagram	41
26	Seat Numbering Diagram	41
27	Network Assignments Screen - Stand-Alone Mode	42
28	Network Assignments Screen - Linked Master Cabinet	42
29	Network Checking Screens	43
30	Indy 500 Twin Graphics	44
31	Indy 500 Twin Cabinet Assembly	46
32	Billboard Assembly	47
33	Billboard Upper Assembly	48
34	Billboard Lower Assembly	49
35	Lamp Assembly	50
36	Control Panel Assembly	51
37	Start and View Button Assembly	53
38	Shifter Assembly	54
39	Gas And Brake Pedal Assembly	56
40	Seat Assembly	58

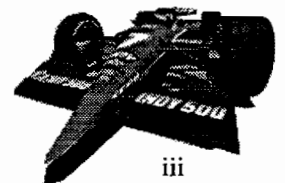

List of Figures (cont.)

41	Game Board Set Assembly	59
42	ROM Board	59
43	Indy 500 Twin Flow Chart	59
44	Drive Control Board	60
45	Motor Drive Board	60
46	Game Board, Power Supply and Fan Locations - Under seat	61
47	Shield Case and Fuse Locations - Under Middle Floorboard	61
48	Shield Case and Fuse Locations - Under Accelerator and Brake Floorboard	62
49	Billboard Lamps Replacement	63
50	Monitor Controls Location	65
51	Nanao Monitor Controls Functions	66
52	Underseat Cabinet Access	67
53	Underseat Cabinet Lid Removal	68
54	AC Fuse Location	69
55	Lubricating the Seat Rails	69
56	Drive Board Location	70
57	Drive Board Dip Switch Location	70
58	Accelerator and Brake Access	71
59	Accelerator and Brake Assembly	72
60	Accelerator and Brake Greasing Access	72
61	Control Panel Access	73
62	Steering Wheel Adjustment	74
63	Steering Wheel Greasing	75
64	Shift Lever Access	76
65	Shift Lever Greasing	76
66	Shift Lever Switch Location	76
67	Button Access	77
68	Wiring Diagram	79

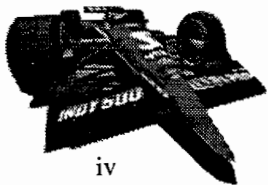

List of Tables

<u>No.</u>	<u>Table Title</u>	<u>Page</u>
1	Indy 500 Twin Specifications	5
2	Installation Items	6
3	Course Descriptions	15
4	On-Screen Indicators	16
5	Test Mode Scheduling	17
6	Service Panel Functions	18
7	Control Value Ranges	22
8	Race Mode Lap Lengths	27
9	Sound Level Settings	28
10	Coin/Credit Settings	30
11	Manual Settings: Coin to Credit	32
12	Manual Settings: Bonus Adder	32
13	Manual Settings: Coin Chute #X Multiplier	32
14	Periodic Check and Maintenance Items	38
15	Troubleshooting Guide	39
16	Indy 500 Twin Graphics Parts List	45
17	Billboard Parts List	47
18	Billboard Upper Parts List	48
19	Billboard Lower Parts List	49
20	Lamp Parts List	50
21	Control Panel Parts List	52
22	Start and View Button Parts List	53
23	Shifter Parts List	55
24	Gas and Brake Pedal Parts List	57
25	Seat Parts List	58
26	Drive Board DIP Switch 1 Settings	70

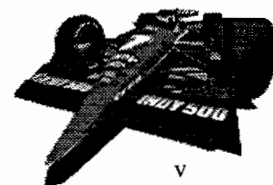

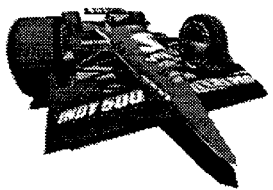

INTRODUCTION OF THE OWNER'S MANUAL

SEGA ENTERPRISES, LTD., supported by its high technology semiconductors, microprocessors, etc. and a wealth of experience, has for more than 30 years been supplying various innovative and popular game machines to the world market. This Owner's Manual is intended to provide detailed descriptions together with all the necessary information relating to servicing, control, spare parts, and so on, for the Indy 500 Twin, a new SEGA product.

This manual is intended for those who have knowledge of electricity and technical expertise, especially in ICs, CRTs, microprocessors, and circuit boards. Read this manual carefully to acquire sufficient knowledge before working on the machine. Should there be a malfunction, nontechnical personnel should under no circumstances touch the interior system. Should the need arise, contact our Main Office or the closest branch office listed:

SEGA ENTERPRISES, INC. (U.S.A.)

Customer Service

41533 Industrial Drive

Fremont, CA 94538 USA

Phone (415) 802-1750

FAX: (415) 802-1754

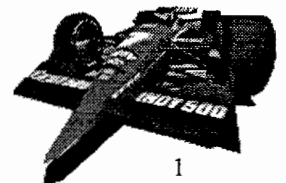

PRODUCT SEALS AND SAFETY CERTIFICATION

PRODUCT LABELING

To prevent counterfeits and conversions, the following labels are put on all SEGA products. When handling such goods, be sure to confirm the labels. They are used to prevent illegal acts such as the unauthorized copying of merchandise or by converting, selling or using products or printed circuit boards.

ORIGINAL SEAL

The following seal is put on all machines manufactured by SEGA.



LICENSE SEAL

The following seal is put on all SEGA kits, such as printed circuit boards.



SAFETY CERTIFICATION

UL[®] Listed Amusement Machine: Model SUR-0017-001
FCC Part 15 Subpart J, class A

This equipment has been tested and found to comply with the limits for a Class A digital device in accordance with the specifications in Part 15 of the FCC rules. Operation is subject to the following two conditions: (1) This device may not cause harmful interference, and (2) this device must accept any interference received, including interference that may cause undesired operation.

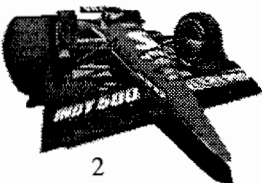

HANDLING PRECAUTIONS

_ When installing or inspecting the machine, be aware of the following safety items. Pay attention so that the players can enjoy the game safely.

- Turn the power off before working on the machine.
- Do not insert or pull out the plug quickly.
- Make sure that the power cord and ground wire are not exposed during transportation. Make sure that all ground connections are made safely at the installation position where specified.
- Do not use any fuse that does not meet the specified rating.
- Make complete connections for the IC board and other connections. Insufficient connections are very dangerous.
- When cleaning the monitor glass, use a soft cloth. Do not apply chemicals such as benzine or thinner.
- Sega Enterprises, Inc. (U.S.A.) is not liable for any damages or injury resulting from use of this equipment in a manner for which it was not designed or intended.

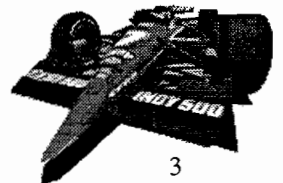

INSTALLATION AND LOCATION PRECAUTIONS

The Indy 500 Twin is an indoor game machine. Absolutely do not install it outside. Even indoors, to ensure proper usage, avoid installing in any of the places mentioned below. Follow all of the installation instructions and precautions when installing the machine.

LOCATION PRECAUTIONS:

- Places subject to rain or water leakage, or condensation due to humidity.
- In the proximity of an indoor swimming pool and/or shower.
- Places subject to direct sunlight.
- Places subject to heat sources from heating units or hot air.
- In the vicinity of highly inflammable/volatile chemicals or hazardous matter.
- On sloped surfaces.
- In the vicinity of anti-disaster facilities such as fire exits and fire extinguishers.
- Places subject to any type of violent impact.
- Dusty places.

INSTALLATION PRECAUTIONS:

- Do not insert more than one electrical plug into the power plug socket.
- The per unit standard voltage/amperage is 120V/10A.
- Use of extension cords should be avoided. If you must use an extension cord, ensure the extension cord is rated at 15A or higher.
- For transporting the machine into the location's building, the minimum necessary dimensions of the opening (doors, etc.) are 35 in. (W) x 70 in. (H).
- For operation of the machine, the minimum installation dimensions are 62 in. (W) x 65 in. (D).
- Due to its size and weight, use at least four (4) people to uncrate this game.

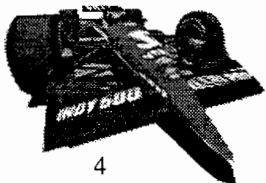

SPECIFICATIONS

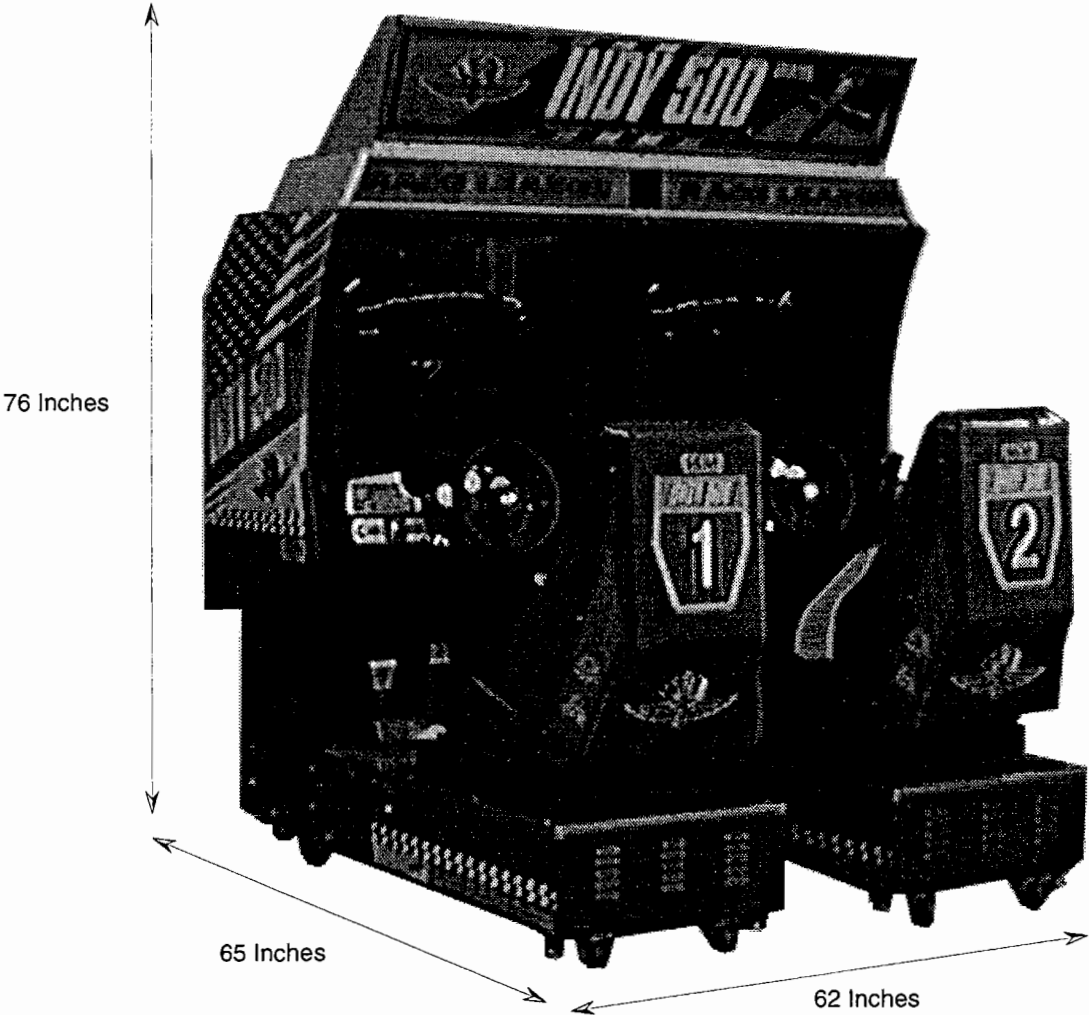
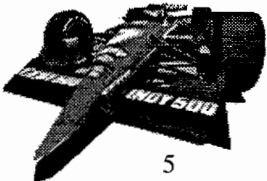

FIGURE 1: INDY 500 TWIN INSTALLATION DIMENSIONS

Table 1: Indy 500 Twin Specifications

PARAMETER	SPECIFICATION
Dimensions:	
Crate 1	33 in. (W) x 67 in. (D) x 62 in. (H)
Crate 2	33 in. (W) x 67 in. (D) x 62 in. (H)
Crate 3	29 in. (W) x 62 in. (D) x 20 in. (H)
Installed	62 in. (W) x 65 in. (D) x 76 in. (H)
Weight	1200 lbs.
Power & Current	900 W, 7.5A (120 VAC, 60 Hz)



INSTALLATION ITEMS

The items listed in Table 2 are supplied with the Indy 500 Twin and should be included with the machine whenever the machine is moved.

TABLE 2: INSTALLATION ITEMS

PART NAME	QTY.	LOCATION	PART NUMBER
Owner's Manual - Indy 500 Twin	1	In Cash Box	4201-6184-03
Quickstart Card - Indy 500 Twin	1	In Cash Box	
Left-side Cabinet	1	Crate 1	
Right-side Cabinet	1	Crate 2	
Cash Box Tower	1	Crate 3 (Crate 3 is strapped to Crate 2)	
Joint Plate	1	Crate 3	
Billboard	1	Crate 3	
Billboard L-Brackets	2	In corners of Crate 3	
Linking Fiber Optic Cable	1	Coiled in Cash Box Tower	600-6275-0500
Mounting Bolts and Washers:		In Installation Holes:	
Left- and Right-side	4	Outside of Inner Panels	
Billboard:			
Top of Right-side Cabinet	4	2 front edge, 2 back edge	
Top of Left-side Cabinet	4	2 front edge, 2 back edge	
Back of Billboard	4	Back Panel of Billboard	
Tools:		In Cash Box	
Allen Wrench	1		
Torx Anti-Tamper Wrenches:			
M5	1		540-0007-01
M8	1		540-0009-01
Keys:			
Coin Mech Door	2	Strapped to Controls	
Cash Box	2	Behind Coin Mech Door	
Underseat Compartments	4	Behind Coin Mech Door	

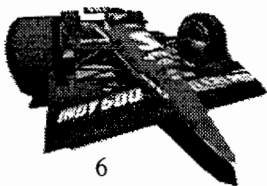

ASSEMBLING THE MACHINE

WARNING!

When moving or lifting the INDY 500 TWIN game cabinet over surfaces of differing levels (steps and stairs), separate the left- and right-hand sides before moving the cabinet. Moving or lifting the cabinet while the left and right sides are connected may cause damage to the cabinet.

UNCRATE LEFT-SIDE CABINET (CRATE #1)

1. Move shipping crate #1 containing the left-side cabinet into location near the final installation location while still on the pallet.
2. Carefully remove the shipping bands, and top and sides of the crate.
3. Lift the left-side cabinet out and set on its casters.
4. Roll the left-side cabinet into its approximate installation location. Note: The left-side cabinet has the power cord and the On/Off switch.

UNCRATE RIGHT-SIDE CABINET (CRATE #2)

1. Move shipping crate #2 containing the right-side cabinet into location near the final installation location while still on the pallet.
2. Carefully remove the shipping bands, set aside crate #3, and remove and top and sides of crate #2.
3. Lift the right-side cabinet out and set on its casters.
4. Roll the right-side cabinet into its approximate installation location.

UNCRATE CASH BOX TOWER AND BILLBOARD (CRATE #3)

1. Move shipping crate #3 containing the Cash Box Tower and the Billboard into location near the final installation location while still on the pallet.
2. Carefully remove the shipping bands, and top and sides of the crate.
3. Lift out the Billboard, two L-brackets, and Joint Plate and set aside in a protected location.
4. Lift the Cash Box Tower out and set near its approximate installation location between the left- and right-side cabinets (see Figure 2).

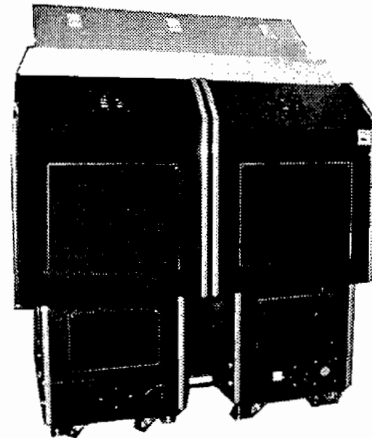
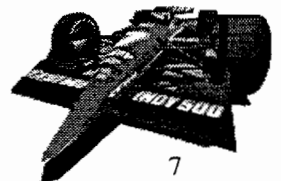

FIGURE 2: REAR VIEW, ASSEMBLED INDY 500 TWIN CABINET

PREPARE CABINETS AND TOWER FOR ASSEMBLY

1. Unscrew and remove the rear cover of the Cash Box Tower and set the cover aside.
2. Untape the wire harnesses from the outside of the inner panels of the left and right-side cabinets and the outside of the Cash Box Tower (see Figure 2).
3. Peel the blue protective covering off all silver trim strips on both left- and right-side cabinets.
4. Remove the upper two bolts and split washers from the outside of the inner panel of the left and right-side cabinets. Keep these bolts and washers available.
5. Loosen approximately 1/4 inch the lower two bolts on the outside of the inner panel of the left and right-side cabinets. Do not remove the lower two bolts.



INSTALL RIGHT-SIDE CABINET

1. Connect the two right-side cable connectors to the Cash Box cable right-side connectors. Feed excess cable into the cabinet or Cash Box Tower.
2. Attach the Cash Box Tower to the inner panel of the right-side cabinet (see Figure 3) by lifting up the Cash Box tower and slipping the lower two slotted holes in the tower side over the lower two bolts and split washers on the right-side cabinet. Watch out for the sloping lower edge of the right-side cabinet monitor when lifting and installing the Cash Box Tower. The fender (large) washer stays between the right-side cabinet and the Cash Box Tower. Be sure that the cables retract into either the cabinet or Cash Box Tower without kinking. Do not tighten the bolts yet.
3. Install the two upper bolts and washers from the inside of the Cash Box Tower (through the non-slotted holes) into the right-side cabinet. After making sure that the cables are not caught between the cabinet and Cash Box Tower, and that the Tower is resting snugly against the cabinet, tighten all four bolts from the inside of the Cash Box Tower.

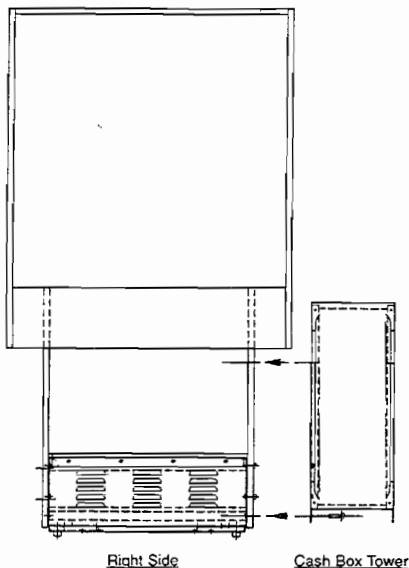

FIGURE 3: RIGHT-SIDE CABINET INSTALLATION

INSTALL LEFT-SIDE CABINET

1. Connect the two left-side cable connectors to the Cash Box cable left-side connectors. Feed excess cable into the cabinet or Cash Box Tower.
2. Attach the Cash Box Tower to the inner panel of the left-side cabinet (see Figure 4) by sliding the lower two slotted holes in the Cash Box tower over the lower two bolts and split washers on the left-side cabinet. Watch out for the sloping lower edge of the left-side cabinet monitor. The fender (large) washer stays between the left-side cabinet and the Cash Box Tower. Be sure that the cables retract into either the cabinet or Cash Box Tower without kinking. Do not tighten the bolts yet.
3. Install the two upper bolts and washers from the inside of the Cash Box Tower (through the non-slotted holes) into the left-side cabinet. After making sure that the cables are not caught between the cabinet and Cash Box Tower, and that the Tower is resting snugly against the cabinet, tighten all four bolts from the inside of the Cash Box Tower.

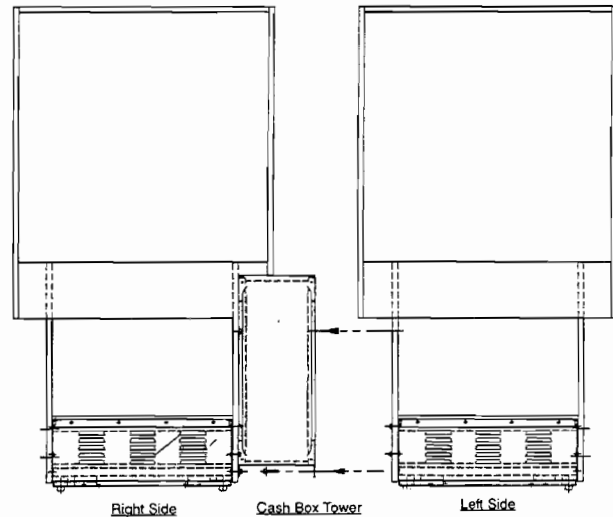
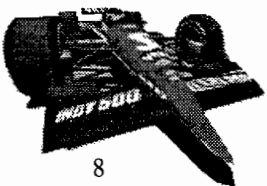

FIGURE 4: LEFT-SIDE CABINET INSTALLATION



INSTALL BILLBOARD

1. Remove four 5/16 hex Billboard installation bolts from the top of both the left and right-side cabinets (8 total). Remove four 5/16 hex Billboard installation bolts from the back edge of the Billboard.
2. Carefully lift the Billboard to the top of the cabinets (see Figure 5).
3. Remove the three access screws from the front edge of the Billboard between the Billboard and Race Leader Marquee.
4. Open the Billboard top section carefully.
5. Attach the Billboard to the top of the game cabinet using four 5/16 hex bolts installed inside the front edge of the Billboard (see Figures 5 and 6). Do not tighten the bolts yet.
6. Attach the Billboard to the top of the game cabinet using 4 5/16 hex bolts installed through the L-bracket along the back outside edge the Billboard (see Figures 5 and 6). Do not tighten the bolts yet.
7. Align the Billboard and tighten all the bolts.
8. From inside the Billboard, connect the three- and four-pin Molex connectors (one each) to provide power to the lamps.
9. Reinstall the three access screws along the front edge of the Billboard to close the Billboard case.

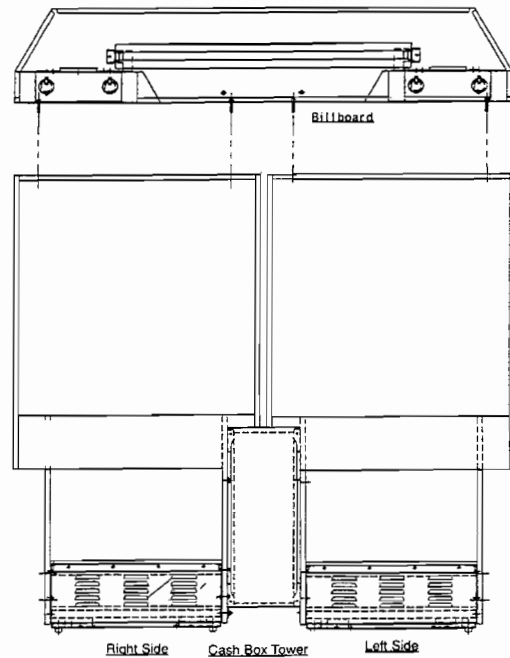

FIGURE 5: BILLBOARD INSTALLATION LOCATION

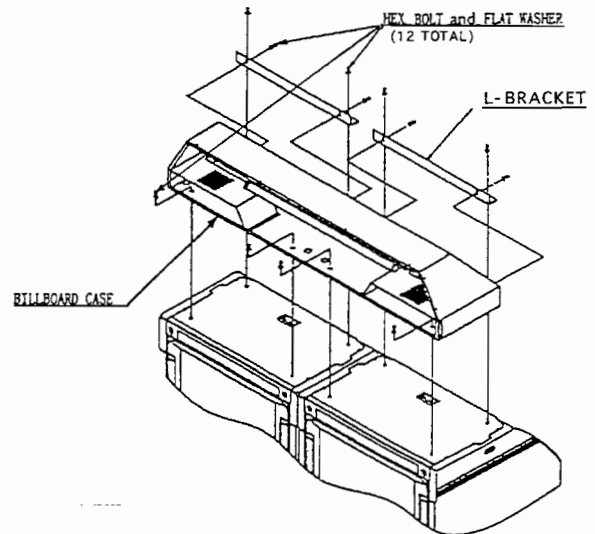
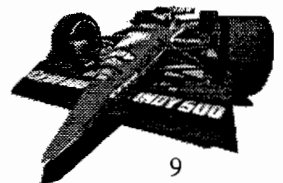

FIGURE 6: BILLBOARD INSTALLATION DETAILS



WARNING!

Make sure that all eight of the leg levelers are in contact with the floor (see Figure 9). If they are not, the cabinet may move and cause an accident.

ADJUST LEG LEVELERS

1. Move the game cabinet to its final installation position. Be sure to allow room for the players to climb on the machine.
2. Adjust the six outboard leg levelers (see Figure 7) on the cabinet by hand so they all make contact with the floor. Continue to adjust levelers until the machine is level and the casters are approximately 5 mm off of the floor (see Figure 8). If the casters are less than 5 mm off of the floor, the game may move during operation and become dangerous.
3. After the adjustments are complete, tighten each leg leveler nut upward to secure the height of the leg leveler. (See Figure 9.)
4. Attach the red joint plate (shipped in Crate 3) to the cabinet's two inner leg levelers (see Figures 7 and 10). Slide the notches in the joint plate over the levelers.
5. Adjust the two inner leg levelers (see Figure 7) on the cabinet by hand so they both make contact with the floor. Continue to adjust levelers until the machine is level and the casters are approximately 5 mm off of the floor (see Figure 8). If the casters are less than 5 mm off of the floor, the game may move during operation and become dangerous.
6. After the adjustments are complete, tighten both leg leveler nuts upward to secure the height of the leg leveler. (See Figure 9.)
7. Since the cabinet is heavy, retract its leg levelers and roll on its casters (see Figure 9) when moving the machine over the floor. Do not move the assembled cabinet over uneven floors, or up or down steps and stairs. Detach the left and right-side cabinets from the Cash Box Tower before moving the cabinets over uneven areas.

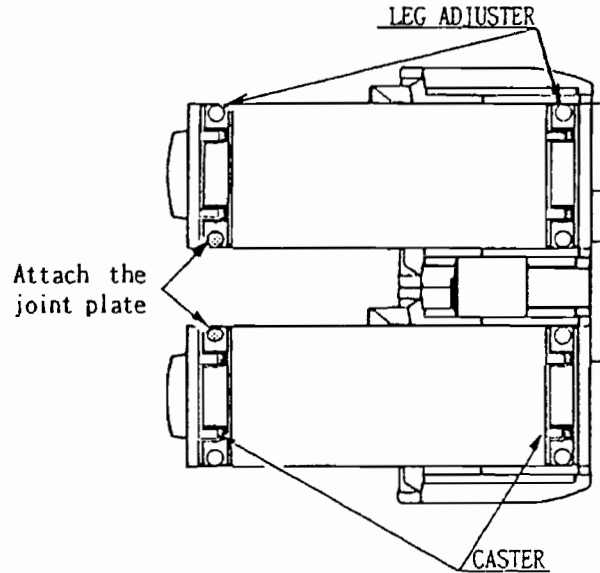

FIGURE 7: CABINET, BOTTOM VIEW

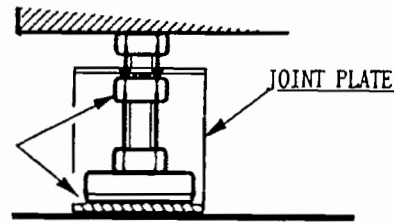

FIGURE 8: LEG LEVELERS, BOTTOM VIEW

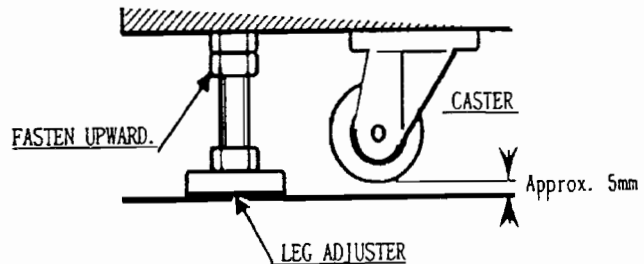
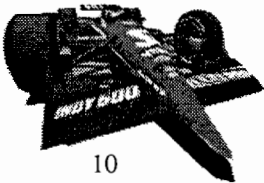

FIGURE 9: LEG LEVELER AND CASTER, SIDE VIEW



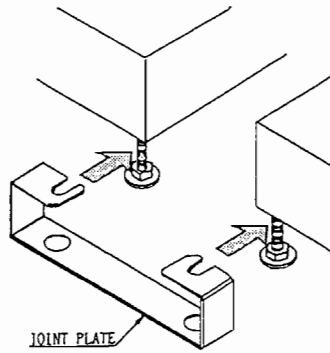

FIGURE 10: JOINT PLATE INSTALLATION

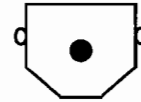

FIGURE 11: FIBER OPTIC CABLE CONNECTOR

LINKING LEFT- AND RIGHT-SIDE CABINETS

1. Locate the fiber optic linking cable (shipped in the cash box).
2. The cable and machine linking connectors are keyed so that they can only be connected when the long flat side of the cable connector is facing up (see Figure 11).
3. At the center rear of the machine, insert the black end of the linking cable into the TX connector and the red end into the RX connector (see Figure 12).
4. For information on linking multiple machines (4, 6, or 8 player linking) see the Machine Options: Linking section.
5. Loop and tuck the excess fiber optic cable between the left- and right-side cabinets. Do not bend the fiber optic cable.

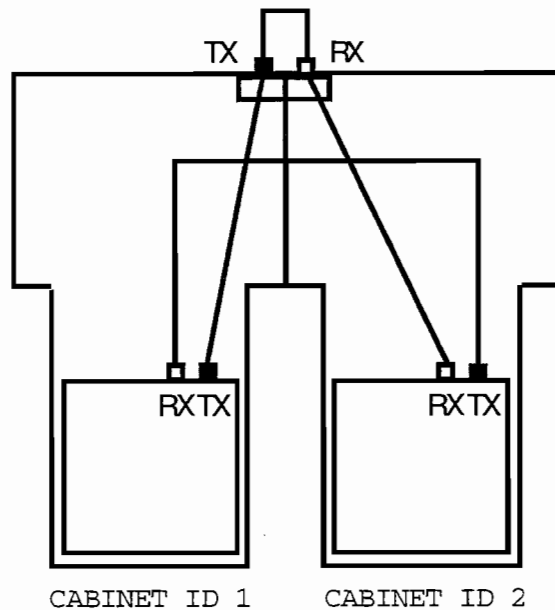
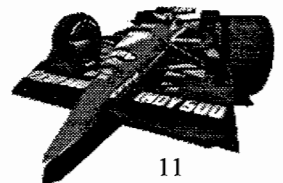

FIGURE 12: TWO PLAYER LINKING



POWER ON

1. Plug the AC cord going from the rear of the left-side cabinet into a dedicated outlet.
2. Toggle the Main AC Switch, located at the lower center rear of the game cabinet. This will cause the machine to power up and run a Power On Check.
3. During the Power On Check, the steering wheel will turn left and right, then returns to the centered position (see Figure 13), allowing the control parameter values to be corrected (on the game board). Do not touch the steering wheel or other controls while the Power On Check is in progress or the steering wheel reaction during the game will be incorrect.
4. After the Power On Check is complete, the machine runs a Network Check to initiate communication with other linked machines. During this check, the Network Check screen appears (see Figure 14). The Network Check should take approximately 10 seconds. If it does not complete in 10 seconds, check the fiber optic cable connections (see the Machine Options: Linking section).

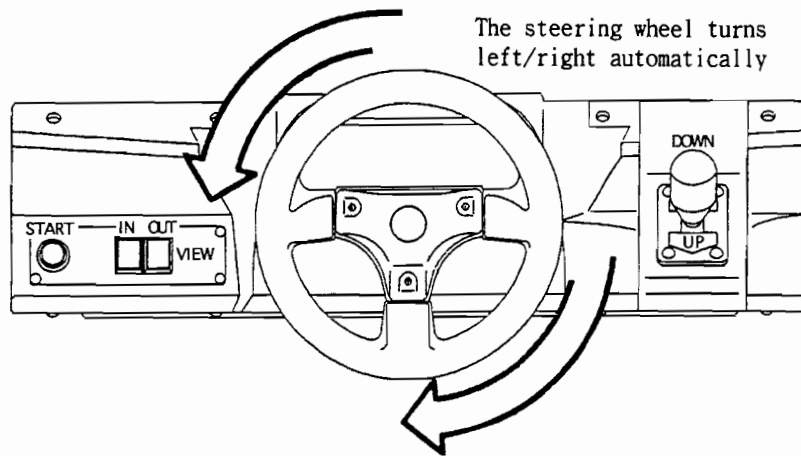

FIGURE 13: POWER-ON CHECK OF STEERING WHEEL

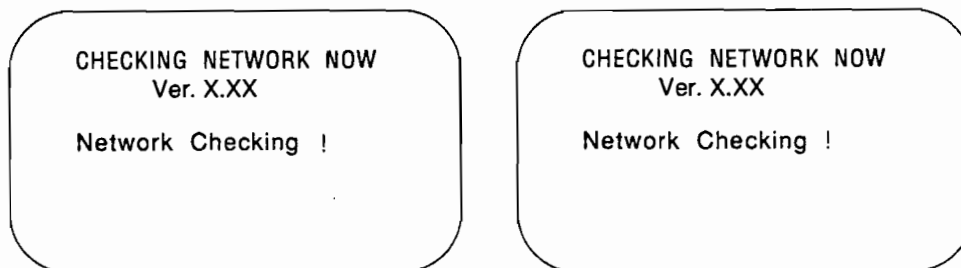
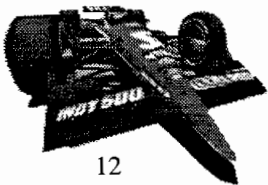

FIGURE 14: NETWORK CHECK SCREENS



CHECK GAME BOARD PARAMETERS

After the Network Check is complete, the Game Board Parameters should be checked. Open the Coin Mech Door and press the Test Button on the Service Panel (see Figure 15) to place the machine in Test Mode. See the Test Menus section for further details.

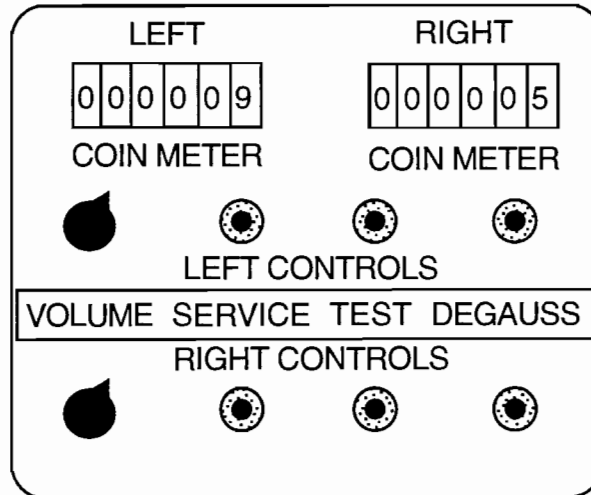
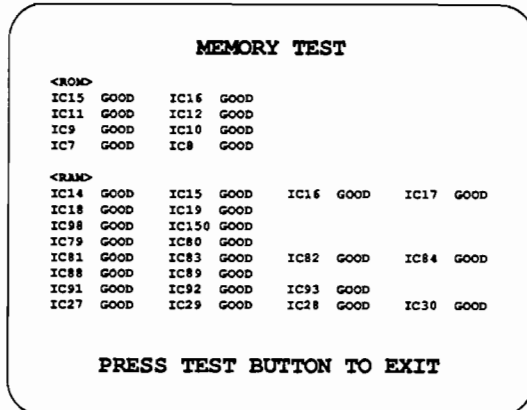
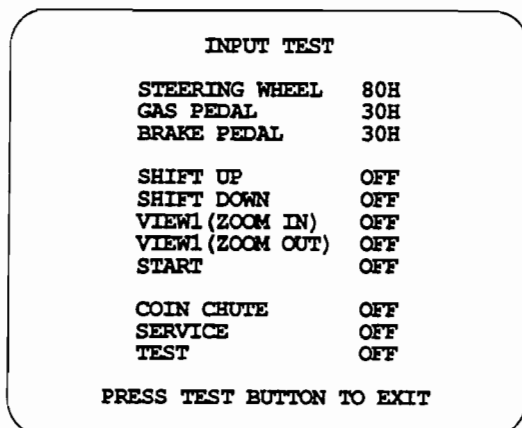

FIGURE 15: SERVICE PANEL CONTROLS

In Test Menu, perform the following tests (see the Test Menu section for detailed instructions):



Selecting the Memory Test from the Test Menu allows the game board memory ICs to be tested. Allow approximately 75 seconds for this test to complete. All ICs should show "GOOD."



Selecting the Input Test from the Test Menu allows each switch and button to be tested. Press each switch and button. For the coin switch test, insert a coin in the coin inlet with the coin chute door open. If the display beside each switch and button shows "GOOD", the switches, buttons, and wiring connections are good. Operate the steering wheel and gas and brake pedals and ascertain that the values shown vary from low to high as given in the Test Menu section for the Input Test.

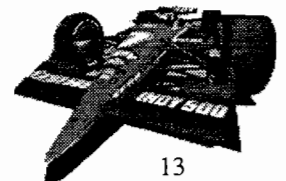

OUTPUT TEST

CENTERING LEVEL 0

START LAMP OFF

VIEW1 LAMP (ZOOM IN) OFF

VIEW2 LAMP (ZOOM OUT) OFF

->EXIT

**SELECT WITH SERVICE BUTTON
AND PRESS TEST BUTTON**

Selecting the Output Test from the Test Menu allows each lamp to be tested and the centering level for the Steering Wheel to be verified and adjusted if necessary. If the Steering Wheel centering level needs adjustments, make them according to the instructions given in the Output Test sections.

SOUND TEST

No. 0

**SELECT WITH SERVICE BUTTON
PRESS TEST BUTTON TO EXIT**

Selecting the Sound Test from the Test Menu allows each speaker to be verified. Be sure to verify that sound is emitted from each speaker at a satisfactory volume.

C.R.T. TEST 1/2

RED
GREEN
BLUE
WHITE

PRESS TEST BUTTON TO CONTINUE

Selecting the C.R.T. Test from the Test Menu allows verification of the CRT's adjustment. Although projector adjustments are made at the time of shipment, color deviation or other maladjustments may occur due to geomagnetism, other game machinery, or other factors. View the test screens and make a judgment as to whether adjustments are necessary. If adjustments are necessary, make them according to the instructions given in the C.R.T. Test and Service Information sections.

C.R.T. TEST 2/2

PRESS TEST BUTTON TO EXIT

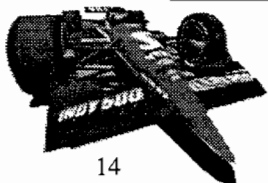

HOW TO PLAY

- The following explanations apply to the case where the Indy 500 Twin is operating in the SINGLE mode. In cases where multiple machines are *linked*, see the Machine Options: Linking Instructions section.

1. Insert a coin(s). Inserting enough coins for one play causes the Game Select mode to appear on the screen.
2. The Course Select screen (see Figure 16) showing “INDY 500”, “HIGHLAND RACEWAY” and “BAYSIDE STREET” appears. The courses are described in Table 3. Turn the steering wheel to select the course, and make the selection by stepping on the Gas Pedal or pressing the Start Button. (See Figure 18 for control locations.) If the game is played in linked mode, the course selection is determined by a majority of the players, or, in the case of a tie, the course is selected from the tied courses in the order listed above.

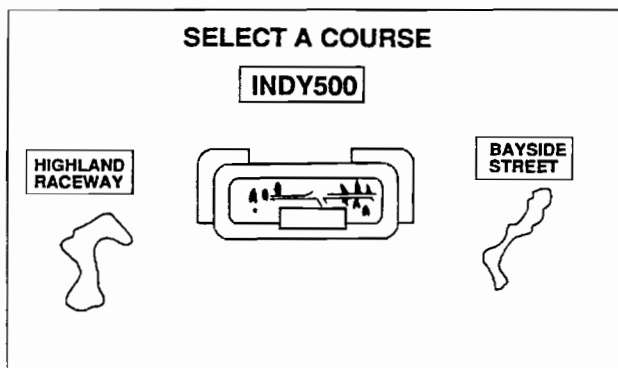

FIGURE 16: COURSE SELECTION

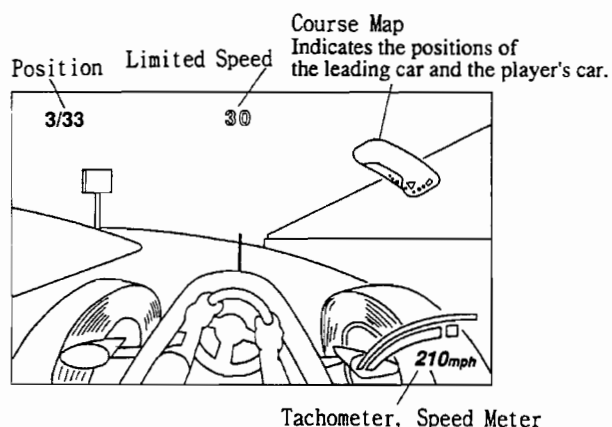

FIGURE 17: ON-SCREEN DISPLAY LOCATIONS

Table 3: Course Descriptions

COURSE	No. of LAPS	CHECK POINTS	COURSE DESCRIPTION
Highland Raceway	3	2	Imaginary course through the folds of the hills. Features sharp ups and downs.
Indy 500	4	1	Reproduction of the actual Indianapolis Motor Speedway. It is an oval course that is almost rectangular.
Bayside Street	4	1	Imaginary course through the streets of town. Both sides of the road are concrete walls. This is the most difficult of the three courses.

3. There are 2 transmissions to choose from: AUTO and 6-speed MANUAL. Turn the steering wheel to select the desired transmission and make the selection by stepping on the Gas Pedal or pressing the Start Button. It is recommended that you choose AUTOMATIC transmission if you are not familiar with the game. When MANUAL SHIFT is chosen, refer to the Tachometer for shifting. Shifting up when the indicator is just below the red zone allows the most efficient acceleration.
4. After the course and transmission have been selected, the race begins with a rolling start.
5. During play, the driver’s perspective can be alternated by using the View Change Buttons to select one of 4 views.
6. To disable the Steering Wheel reactions, press the View Change Zoom Out and Start Buttons simultaneously.
7. The on-screen indicators during a race are shown in Figure 17 and described in Table 4.

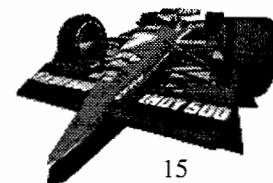

Table 4: On-Screen Indicators

LOCATION	INDICATOR(S)
Upper Left	Player's current numerical position in the field over total field size.
Upper Middle	Remaining time to the next checkpoint.
Upper Right	Section time between checkpoints, with the best section time to date displayed above the player's last section time.
Middle Left	Record Lap time for the current lap, the running Total Time, and the Lap Times for all completed laps, and the current running Lap Time.
Middle Right	Course Map with markers for all cars in the field (purple dots), player's present position (blue triangle), and leader's position (green diamond).
Lower Right	Tachometer (green bar) with Shift Indicator (red bar), Current Speed, and Current Gear (number and bar).

8. After the game is started, the allotted time decreases. Passing the 1 to 3 checkpoint(s) per lap (depends on the course selected) within the time limit allows the game to continue with the previous remaining time added to the time limit up to the next checkpoint. If you fail to pass a checkpoint within the allotted time limit, the game is over.
9. During play, the position of all on-screen cars in the race can be viewed by pressing the Start Button. Press the Start Button again to return to the default view.
10. The top ten players who finish the course with the best results can register his or her name. Turn the steering wheel to choose the alphabetical letters and step on the Accelerator to make the selection. The name will be displayed on the DEMO screen.

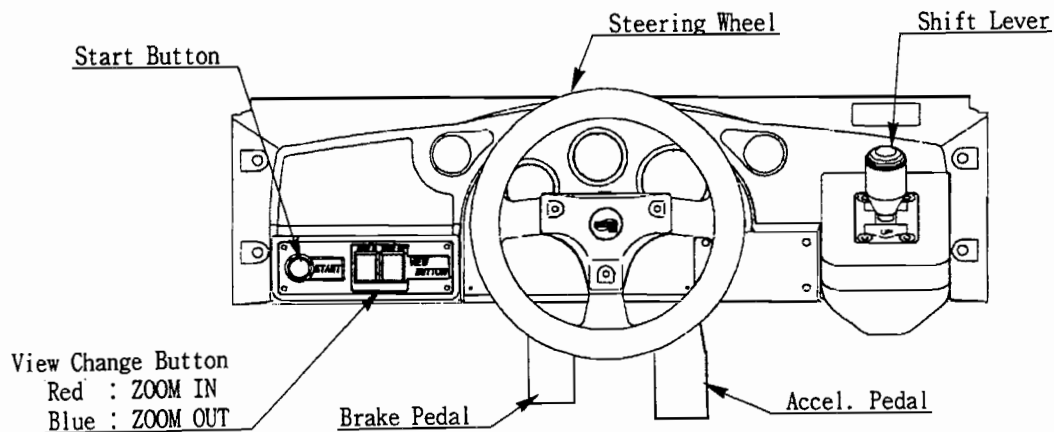
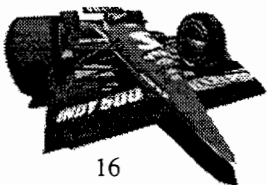

FIGURE 18: CONTROL LOCATIONS



EXPLANATION OF TEST AND DATA DISPLAYS

-TEST MODE SCHEDULING

The machine should be tested whenever it is installed, when cash is collected, monthly, or whenever the machine is not operating correctly. This is done by pressing the Test Button on the Service Panel. The tests and modes listed in Table 5 should be used as applicable.

TABLE 5: EXPLANATION OF TEST MODES

ITEMS	DESCRIPTION
INSTALLATION OF MACHINE	When the machine is installed, perform the following: 1. Check to see that each setting is per the manufacturer's default setting, made at the time of shipment. 2. In the Input Test, check each switch and control. 3. In the Output Test check each of the lamps. 4. In the Memory and T.G.P. Tests, check ICs.
MEMORY	Choose Memory or T.G.P. Test to allow the memory test to be performed. In these tests, PROGRAM RAMs, ROMs, and ICs on the IC Board are checked.
PERIODIC SERVICING	Periodically perform the following: 1. Memory and T.G.P. Tests. 2. Ascertain each setting. 3. In the Input Test, test the control devices. 4. In the Output Test, check each of lamps.
CONTROL SYSTEM	1. In the Input Test, check each switch. 2. Adjust or replace each switch. 3. If the problem can not be solved yet, check the control's motion.
MONITOR	1. In the C.R.T. Test, check to see if the monitor adjustments are appropriate. 2. Demagnetize monitor using degauss switch on Service Panel.
IC BOARD	1. Memory Test. 2. Sound Test.
DATA CHECK	Check such data as game play time and histogram to adjust the difficulty level, etc.

IMPORTANT!

Be sure to exit from the Test Menus before turning off power to the machine.

If power is turned off while in the Test Menus,
the new settings will not be stored correctly.

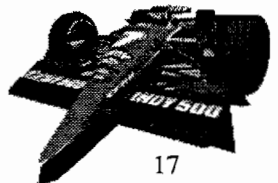

SERVICE PANEL

The Service Panel (see Figure 19) is located behind the Coin Mech Door (see Figure 30). The functions of each control on the Service Unit are described in Table 6. The left- and right-side Service Panels function independently.

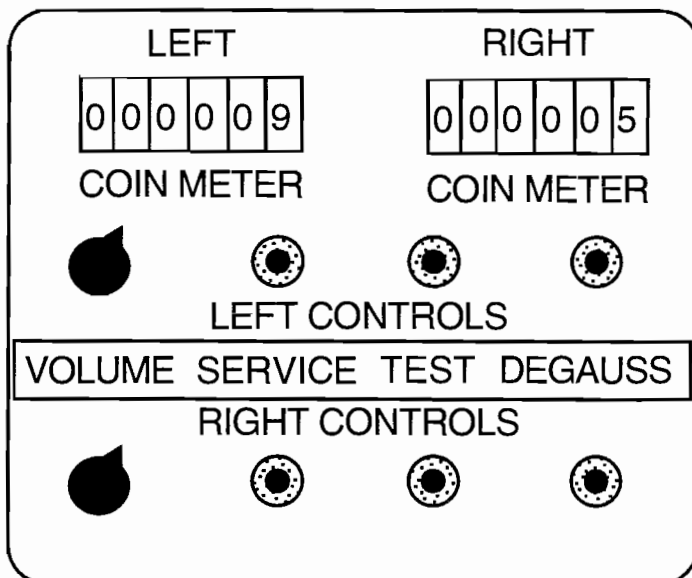
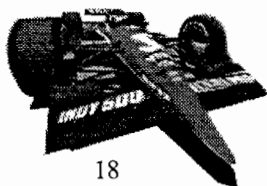

FIGURE 19: SERVICE PANEL CONTROLS AND INDICATORS

TABLE 6: SERVICE PANEL FUNCTIONS

NO.	CONTROL	FUNCTION
1	Service Button	Gives credits without registering on the appropriate coin meter. Also used to select test items (see next sections).
2	Test Button	Enters and runs tests in the Test Menu. For details on the use of the Test Button, see next sections.
3	Volume Knob	Adjusts the volume of the left- and right-side speakers. Volume increases when knob is turned clockwise.
4	Coin Meter	Registers coins accepted for play in left- and right-side coin slots.
5	Degauss Button	Corrects color impurity in the left- and right-side CRTs.



TEST MENU

This menu allows selection of other menus that check the operation of the game board, make monitor color adjustments, and allow for COIN ASSIGNMENTS and GAME ASSIGNMENTS setting adjustments. Each of the Test Items is more fully explained in the following sections.

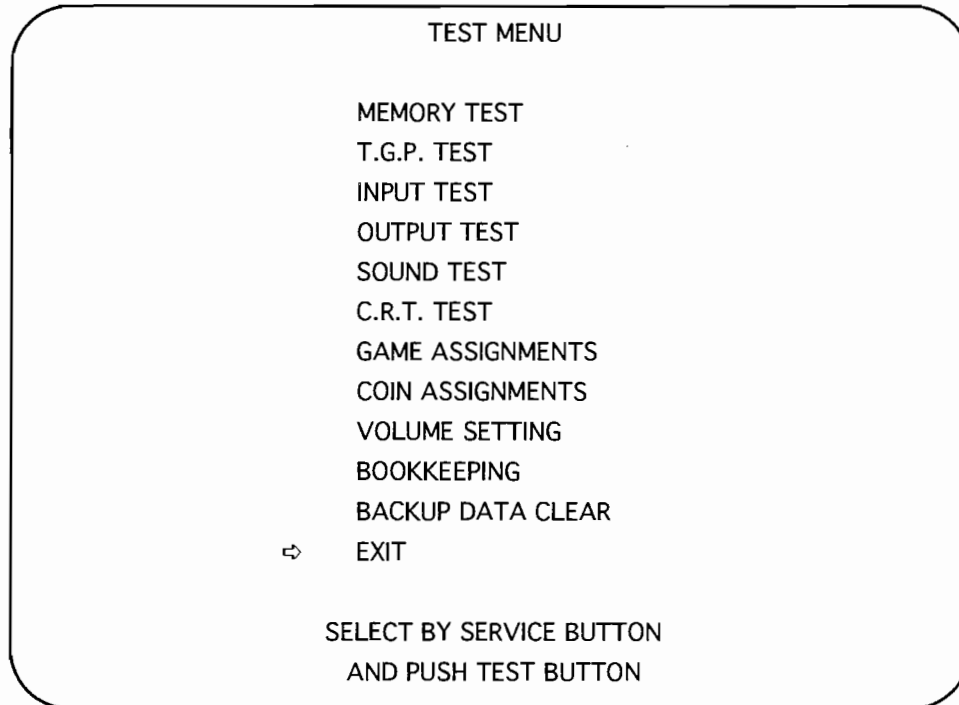

1. Push the Test Button on the Service Panel to cause the Test Menu to appear. Do not enter Test Mode if any linked units are in play. All linked units will enter Test Mode at the same time.
2. Push the Service or View Change Buttons to move the cursor ⇄ to the desired item and press the Test Button.
3. When all testing is completed, move the cursor ⇄ to EXIT and push the Test Button. Be sure to exit from Test Mode before turning off power to the machine. If power is turned off before exiting Test Mode, the new settings will not be saved properly.

IMPORTANT!

Do not enter the Test Mode if any linked machines are in play.
Entering Test Mode causes all linked machines to enter Test Mode.
Be sure to exit from Test Mode before turning off power to the machine. If power is turned off while in Test Mode, the new settings will not be stored correctly.

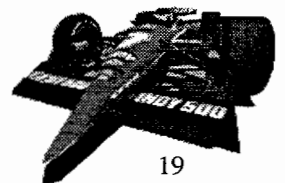

MEMORY TEST

Check the on-board memory ICs.

MEMORY TEST

<ROM >

IC15	GOOD	IC16	GOOD
IC11	GOOD	IC12	GOOD
IC9	GOOD	IC10	GOOD
IC7	GOOD	IC8	GOOD

<RAM>

IC14	GOOD	IC15	GOOD	IC16	GOOD	IC17	GOOD
IC18	GOOD	IC19	GOOD				
IC98	GOOD	IC150	GOOD				
IC79	GOOD	IC80	GOOD				
IC81	GOOD	IC83	GOOD	IC82	GOOD	IC84	GOOD
IC88	GOOD	IC89	GOOD				
IC91	GOOD	IC92	GOOD	IC93	GOOD		
IC27	GOOD	IC29	GOOD	IC28	GOOD	IC30	GOOD

PRESS TEST BUTTON TO EXIT

1. The test takes approximately 75 seconds to complete. If the test exceeds 75 seconds, the board may have malfunctioned.
2. When the IC is in good operating condition, "GOOD" will be indicated.
3. If any of the ICs are malfunctioning, "BAD" will be indicated.
4. Push the Test or Start Button to return to the Test Menu.

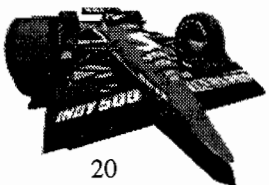

T.G.P. TEST

Check the on-board T.G.P. (screen display) ICs.

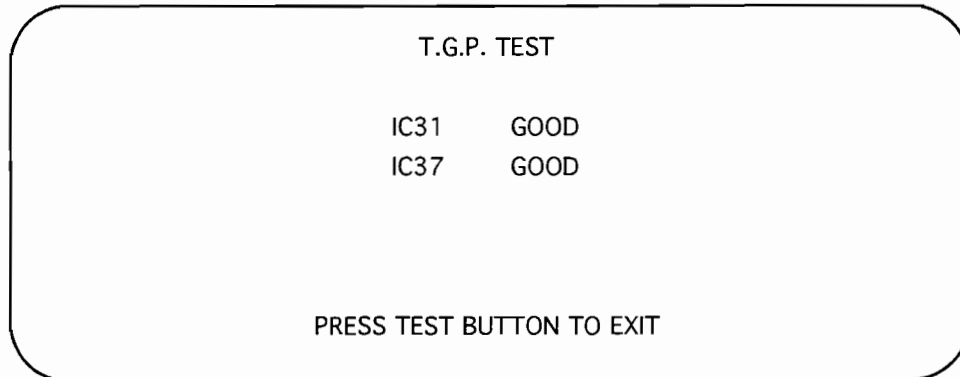

1. When the IC is in good operating condition, "GOOD" will be indicated.
2. If any of the ICs are malfunctioning, "BAD" will be indicated.
3. Push the Test or Start Button to return to the Test Menu.

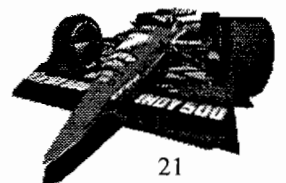

INPUT TEST

This test displays the state of each switch or button and the value of each control, and allows each switch, button, and control to be individually tested.

INPUT TEST	
STEERING WHEEL	80H
GAS PEDAL	30H
BRAKE PEDAL	30H
SHIFT UP	OFF
SHIFT DOWN	OFF
VIEW 1 (ZOOM IN)	OFF
VIEW 2 (ZOOM OUT)	OFF
START	OFF
COIN CHUTE #1	OFF
COIN CHUTE #2	OFF
SERVICE	OFF
TEST	OFF
PRESS TEST BUTTON TO EXIT	

1. Operate each control (steering wheel, gas pedal, and brake pedal). If the values shown range as listed in Table 7, the control is operating satisfactorily.
2. Press each switch or button. If the indicator goes ON when the button is activated, the button is operating and the wiring connections are satisfactory.
3. To check Coin Chutes #1 and #2, open the Coin Chute Door and insert a coin in the slot.
4. Push the Test Button (or the Start and View Change Buttons simultaneously) to return to the Test Menu.

Table 7: CONTROL VALUE RANGES

CONTROL	POSITION	VALUE RANGE
Steering Wheel	Left	Under 2DH
	Right	7DH to 83H
	Centered	Over D3H
Gas Pedal	Released	Under 30H
	Pressed Down	Over C0H
Brake Pedal	Released	Under 30H
	Pressed Down	Over C0H

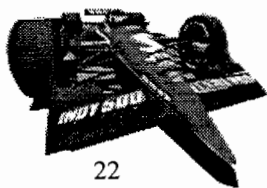

OUTPUT TEST

Allows the Steering Wheel's centering value and the status of each lamp to be checked.

OUTPUT TEST	
CENTERING LEVEL	0
START LAMP	OFF
VIEW 1 LAMP (ZOOM IN)	OFF
VIEW 2 LAMP (ZOOM OUT)	OFF
⇨ EXIT	

SELECT WITH SERVICE BUTTON
AND PRESS TEST BUTTON

1. Press the Service Button or the View Change Buttons to move the cursor ⇨ to the desired test item.
2. Each time the Test Button or Start Button is pressed while CENTERING LEVEL is selected, the CENTERING LEVEL changes in 9 steps (0 to 8 : None to Strongest).
3. If the Steering Wheel's reaction strength cannot be set satisfactorily using this menu, the Drive Board DIP switch settings may need to be changed. See the Service Information: Drive Board DIP Switch Settings section.
4. Lamps should light and the on-screen display should read "ON" when the Test Button is pressed while the corresponding menu item is selected. Press the Test Button again to turn the lamp off and the on-screen display to "OFF".
5. Select EXIT and press the Test Button or Start Button to return to the Test Menu.

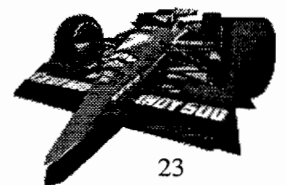

SOUND TEST

This allows each sound and speaker to be verified. Voice and background music (BGM) are emitted from the two round tweeter speakers located one on each side of the control panel, and from the front square speakers also located one on each side of the control panel. Be sure to verify that sound is emitted from each speaker at a satisfactory volume.

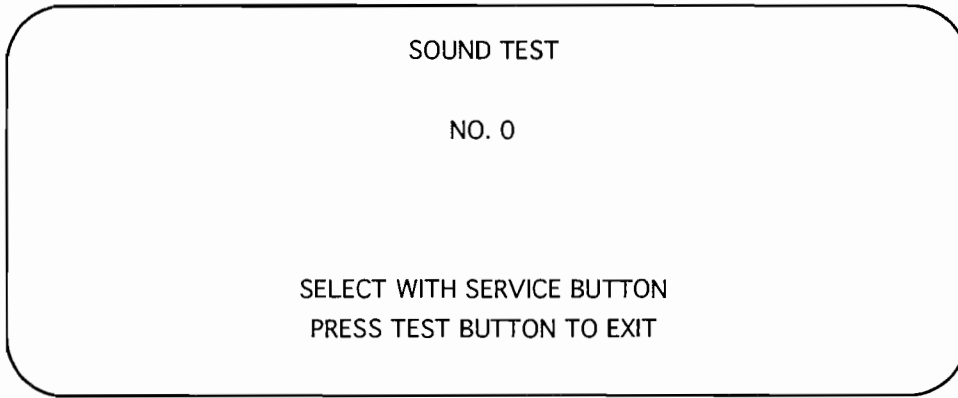

1. Press the Service or View Change Buttons to choose and play the desired sound (No. 0 to 111).
2. Press the Test Button to return to the Test Menu.

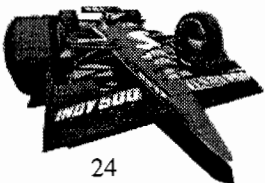

C.R.T. TEST

The two C.R.T. Test screens (RGB Color Adjustment and Monitor Size Adjustment) allow verification of the CRT's adjustment. Although projector adjustments are made at the time of shipment, color deviation or other maladjustments may occur due to geomagnetism, other game machinery, or other factors. View the test screens and make a judgment as to whether adjustments are necessary. If adjustments are necessary, make them according to the instructions given in the Service Information section.

RGB COLOR ADJUSTMENT SCREEN

This screen allows for checking and adjusting the monitor color.

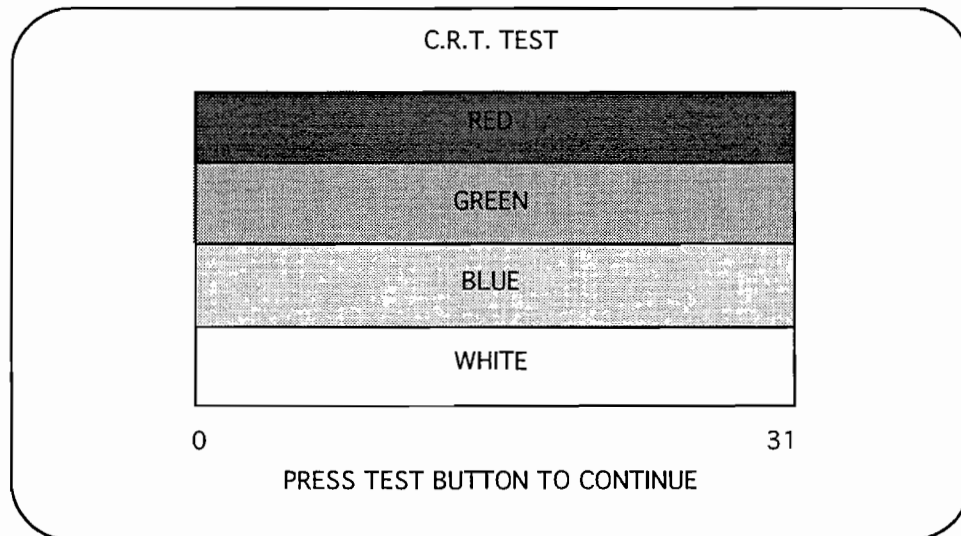

1. View the test screen and decide whether adjustments are necessary.
2. Normally, there is no need to make adjustments.
3. If adjustments are necessary, make them according to the instructions given in the Service Information section.
4. If adjustments are necessary, make them so that each of the R (red), G (green) and B (blue) colors is darkest at the left-hand end and becomes brighter in 16 gradations towards the right-hand end. The monitor brightness is satisfactory if the white color bar is black at the left-hand end and white at the right-hand end.
5. Press the Test or Start Button to go to the Monitor Size Adjustment screen.

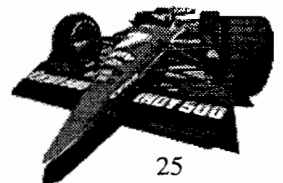

MONITOR SIZE ADJUSTMENT SCREEN

This page allows the monitor size to be checked.

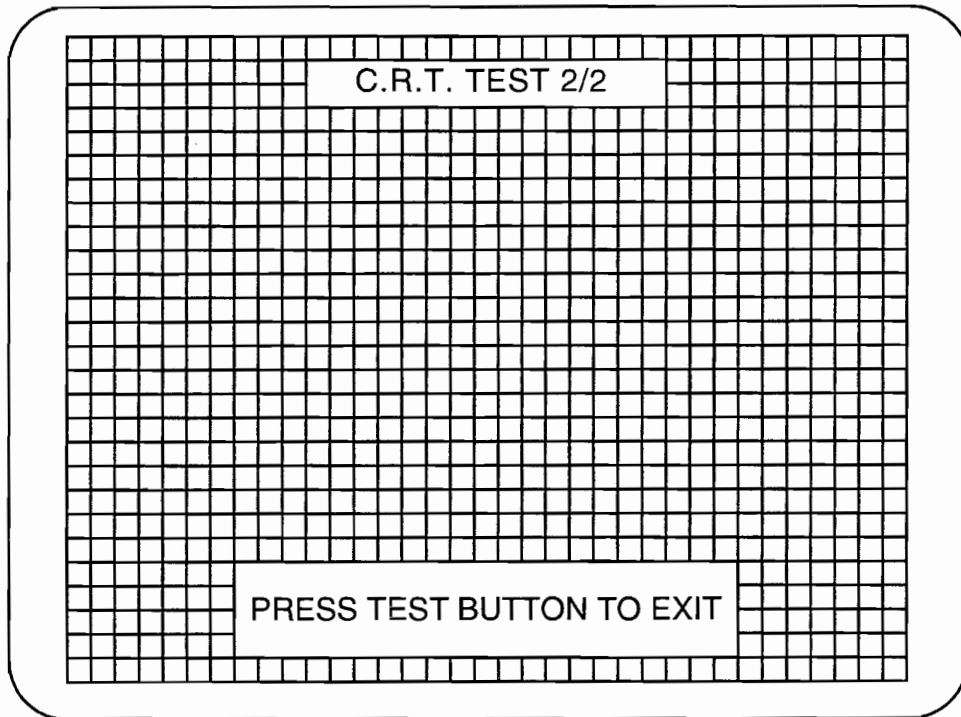

1. View the test screen and decide whether adjustments are necessary.
2. Normally, there is no need to make adjustments.
3. If adjustments are necessary, make them according to the instructions given in the Service Information section.
4. If adjustments are necessary, make them so that the checkered portions of the display do not go beyond the edges of the screen and there is no crosshatch distortion.

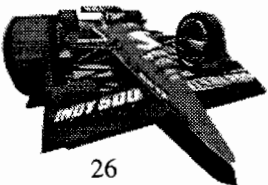

GAME ASSIGNMENTS

Allows game settings to be changed. Ranges are shown in parentheses (). Default values are shown by * =.

GAME ASSIGNMENTS		
GAME DIFFICULTY	NORMAL	A
RACE MODE	NORMAL	B
HANDICAP	ON	C
ADVERTISE SOUND	ON	D
COUNTRY	USA	E
CABINET TYPE	TWIN	F
NETWORK TYPE	NOT LINK	G
CABINET ID	1	H
ENGINE VOLUME	1	I
DEFAULT VIEW	1	J
⇔ EXIT		

SELECT WITH SERVICE BUTTON
AND PRESS TEST BUTTON

1. Press the Service or View Change Buttons to move the cursor ⇔ and bring it to the desired item.
2. Press the Test or Start Button to change the setting.
3. After the desired setting is selected, bring the cursor ⇔ to EXIT and press the Test Button.

(A) GAME DIFFICULTY * = NORMAL
Sets the game's overall difficulty (VERY EASY, EASY, NORMAL, HARD, HARDEST).

(B) RACE MODE * = NORMAL
Sets the lap length per Table 8 (NORMAL, LONG).

Table 8: Race Mode Lap Lengths

MODE	INDY 500	HIGHLAND	BAY SIDE
Normal	4 Laps	3 Laps	3 Laps
Long	20 Laps	17 Laps	15 Laps

(C) HANDICAP * = ON
Speeds up the cars that are in position No. 2 or lower (all cars except position No. 1) in linked play (ON, OFF).

(D) ADVERTISE SOUND * = ON
Determines whether ADVERTISE SOUND is to be emitted or not during Standby Mode (ON, OFF).

(E) COUNTRY * = USA
Selects message language (JPN, EXP, USA).

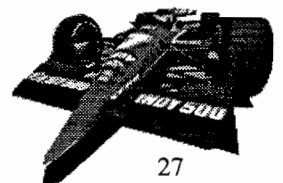

(F) CABINET TYPE

* = TWIN

Setting of cabinet type (DELUXE, TWIN).

(G) NETWORK TYPE

* = STAND ALONE

When machines are not used interactively, set all machines to STAND ALONE. For linked (communication) play, set CABINET ID #1 to MASTER, and the remaining cars to SLAVE, as described in the Machine Options section - Linking Instructions (STAND ALONE, MASTER, SLAVE).

(H) CABINET ID

* = 1

When cabinets are used in linked play, the CABINET ID's must be set as described in the Machine Options section - Linking Instructions or the on-screen displays will be confused (1 to 8).

(I) ENGINE VOLUME

* = 1

Sets the balance between the sound levels of the engine and the background music during the race, as shown in Table 9. (1 to 3).

Table 9: Sound Level Settings

SETTING	ENGINE VOLUME	MUSIC VOLUME
1	Low	Loud
2	Even	Even
3	Loud	Low

(J) DEFAULT VIEW

* = 1

Sets the default view seen before any View Change Buttons are pressed during the race (1:Lowest View Point to 4:Highest View Point).

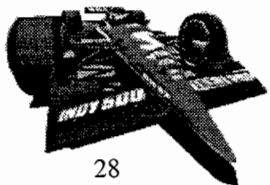

COIN ASSIGNMENT

In this mode, the COIN/CREDIT setting, number of credits to start, and basic coin and credit levels can be changed. Default values are shown by * =.

COIN/CREDIT

COIN ASSIGNMENT

COIN/CREDIT SETTING #18

COIN CHUTE #1
4 COINS 1 CREDIT

COIN CHUTE #2
4 COINS 1 CREDIT

MANUAL SETTING

⇔ EXIT

SELECT WITH SERVICE BUTTON
AND PRESS TEST BUTTON

A

B

1. Press the Service Button or View Change Button to select an item.
2. Press the Test Button or Start Button to change the setting.
3. To activate the change, select EXIT by using the Service Button, and press the Test Button.

(A) COIN/CREDIT SETTING

* = 18

Sets the CREDIT increase increment per coin insertion. There are 27 settings from #1 to #27, expressed in 00 CREDIT against 00 COINS inserted. #27 refers to FREE PLAY (SETTING #1 in the default setting). For details, refer to Table 10.

(B) MANUAL SETTING

The CREDIT's incremental increase settings for each coin insertion are shown in further detail in Tables 11 - 13.
Note: When MANUAL SETTING is selected, the COIN/CREDIT setting (A) becomes ineffective.

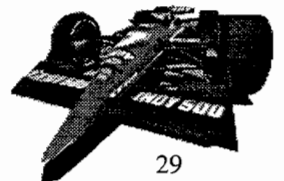
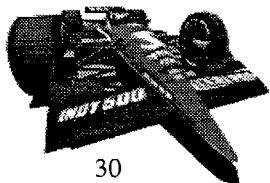

TABLE 10: COIN/CREDIT SETTINGS

NAME OF SETTING	COIN CHUTE 1		COIN CHUTE 2	
SETTING #1	1 COIN	1 CREDIT	1 COIN	1 CREDIT
SETTING #2	1 COIN	2 CREDITS	1 COIN	1 CREDIT
SETTING #3	1 COIN	3 CREDITS	1 COIN	1 CREDIT
SETTING #4	1 COIN	4 CREDITS	1 COIN	1 CREDIT
SETTING #5	1 COIN	5 CREDITS	1 COIN	1 CREDIT
SETTING #6	1 COIN	2 CREDITS	1 COIN	2 CREDITS
SETTING #7	1 COIN	5 CREDITS	1 COIN	2 CREDITS
SETTING #8	1 COIN	3 CREDITS	1 COIN	3 CREDITS
SETTING #9	1 COIN	4 CREDITS	1 COIN	4 CREDITS
SETTING #10	1 COIN	5 CREDITS	1 COIN	5 CREDITS
SETTING #11	1 COIN	6 CREDITS	1 COIN	6 CREDITS
SETTING #12	2 COINS	1 CREDIT	2 COINS	1 CREDIT
SETTING #13	1 COIN	1 CREDIT	2 COINS	1 CREDIT
SETTING #14	1 COIN	2 CREDITS	2 COINS	1 CREDIT
SETTING #15	1 COIN	1 CREDIT	1 COIN	1 CREDIT
	2 COINS	3 CREDITS	2 COINS	3 CREDITS
SETTING #16	1 COIN	3 CREDITS	1 COIN	3 CREDITS
			2 COINS	3 CREDITS
SETTING #17	3 COINS	1 CREDIT	3 COINS	1 CREDIT
SETTING #18	4 COINS	1 CREDIT	4 COINS	1 CREDIT
SETTING #19	1 COIN	1 CREDIT	1 COIN	1 CREDIT
	2 COINS	2 CREDITS	2 COINS	2 CREDITS
	3 COINS	3 CREDITS	3 COINS	3 CREDITS
	4 COINS	5 CREDITS	4 COINS	5 CREDITS
SETTING #20	1 COIN	5 CREDITS	1 COIN	1 CREDIT
			2 COINS	2 CREDITS
			3 COINS	3 CREDITS
			4 COINS	5 CREDITS
SETTING #21	5 COINS	1 CREDIT	5 COINS	1 CREDIT
SETTING #22	1 COIN	2 CREDITS	3 COINS	1 CREDIT
			5 COINS	2 CREDITS
SETTING #23	2 COINS	1 CREDIT	2 COINS	1 CREDIT
	4 COINS	2 CREDITS	4 COINS	2 CREDITS
	5 COINS	3 CREDITS	5 COINS	3 CREDITS
SETTING #24	1 COIN	3 CREDITS	2 COINS	1 CREDIT
			4 COINS	2 CREDITS
			5 COINS	3 CREDITS
SETTING #25	1 COIN	1 CREDIT	1 COIN	1 CREDIT
	2 COINS	2 CREDITS	2 COINS	2 CREDITS
	3 COINS	3 CREDITS	3 COINS	3 CREDITS
	4 COINS	4 CREDITS	4 COINS	4 CREDITS
	5 COINS	6 CREDITS	5 COINS	6 CREDITS
SETTING #26	1 COIN	1 CREDIT	1 COIN	1 CREDIT
			2 COINS	2 CREDITS
			3 COINS	3 CREDITS
			4 COINS	4 CREDITS
			5 COINS	6 CREDITS
SETTING #27	FREE PLAY		FREE PLAY	



MANUAL SETTING

In this mode, the COIN/CREDIT, BONUS ADDER, AND COIN CHUTE settings, etc. can be changed independently.

COIN ASSIGNMENTS		
MANUAL SETTING		
COIN TO CREDIT	3 COINS 1 CREDIT	A
BONUS ADDER	NO BONUS ADDER	B
COIN CHUTE #1	MULTIPLIER	C
	1 COIN COUNTS AS 1 COIN	
COIN CHUTE #2	MULTIPLIER	
	1 COIN COUNTS AS 1 COIN	
⇨ EXIT		

SELECT WITH SERVICE BUTTON
AND PRESS TEST BUTTON

(A) COIN TO CREDIT

Determines Coin/Credit setting. See Table 11.

(B) BONUS ADDER

Sets how many coins should be inserted to obtain one Service Coin. See Table 12.

(C) COIN CHUTE #X MULTIPLIER

Sets how many tokens one Coin represents for COIN CHUTES #1 and #2. See Table 13.

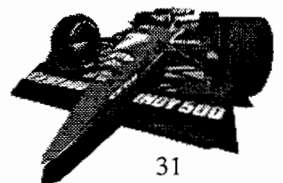

TABLE 11: MANUAL SETTINGS: COIN TO CREDIT

COIN TO CREDIT	1 COIN	1 CREDIT
	2 COINS	1 CREDIT
	3 COINS	1 CREDIT
	4 COINS	1 CREDIT
	5 COINS	1 CREDIT
	6 COINS	1 CREDIT
	7 COINS	1 CREDIT
	8 COINS	1 CREDIT
	9 COINS	1 CREDIT

TABLE 12: MANUAL SETTINGS: BONUS ADDER

BONUS ADDER	NO BONUS ADDER
	2 COINS GIVE 1 EXTRA COIN
	3 COINS GIVE 1 EXTRA COIN
	4 COINS GIVE 1 EXTRA COIN
	5 COINS GIVE 1 EXTRA COIN
	6 COINS GIVE 1 EXTRA COIN
	7 COINS GIVE 1 EXTRA COIN
	8 COINS GIVE 1 EXTRA COIN
	9 COINS GIVE 1 EXTRA COIN

TABLE 13: MANUAL SETTINGS: COIN CHUTE #X MULTIPLIER

COIN CHUTE #1 MULTIPLIER	1 COIN COUNTS AS 1 COIN
	1 COIN COUNTS AS 2 COINS
	1 COIN COUNTS AS 3 COINS
	1 COIN COUNTS AS 4 COINS
	1 COIN COUNTS AS 5 COINS
	1 COIN COUNTS AS 6 COINS
	1 COIN COUNTS AS 7 COINS
	1 COIN COUNTS AS 8 COINS
	1 COIN COUNTS AS 9 COINS

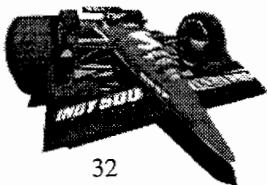

CONTROL RANGE (“VOLUME”) SETTING

Allows the Control Range (“Volume”) of the Gas and Brake Pedals and Steering Wheel to be adjusted.

VOLUME SETTING			
STEERING WHEEL	MAX 93 (DF)	MIN 93 (26)	NEW 93 (93)
GAS PEDAL	MAX 78 (C0)	MIN 78 (78)	
BRAKE PEDAL	MAX 3E (C5)	MIN 3E (3E)	

⇨ CANCEL & EXIT
SET & EXIT

SELECT WITH SERVICE BUTTON
AND PRESS TEST BUTTON

1. To set the Steering Wheel or Pedal (Gas or Brake) values, bring the cursor “Set & Exit”.
2. To cancel, bring the cursor “Cancel & Exit”. Note: if the Steering Wheel or either Pedal is moved even the slightest while you are in this menu, all the settings will be erased. Sega recommends that all settings be reset anytime this menu is entered.
2. Step on the Gas or Brake Pedal fully, then release completely.
3. Turn the Steering Wheel fully to the left and right (see Figure 20) and allow the Steering Wheel to return to level center, as shown in Figure 21.
4. Press the Test Button to store values and return to the Test Menu.

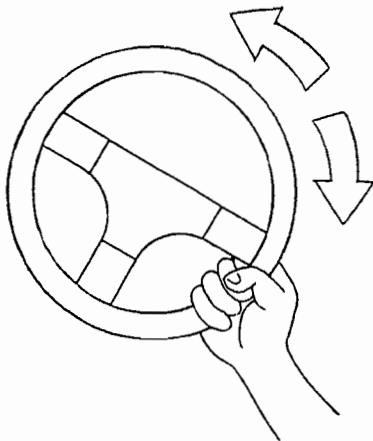

FIGURE 20: TURNING THE STEERING WHEEL

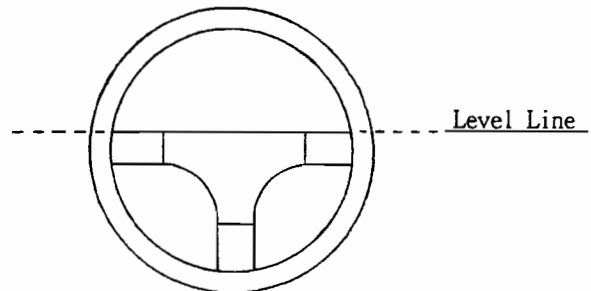
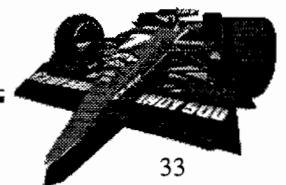

FIGURE 21: CENTERING THE STEERING WHEEL

CAUTION

Sega recommends that all settings be set anytime this menu is entered.



BOOKKEEPING

The two Bookkeeping screens (Credits and Times and Time Histograms) allow display of the game's lifetime bookkeeping data.

CREDITS AND TIMES

BOOKKEEPING 1/2		
COIN CHUTE #1	0	A
COIN CHUTE #2	0	B
TOTAL COINS	0	C
COIN CREDITS	0	D
SERVICE CREDITS	0	E
TOTAL CREDITS	0	F
NUMBER OF GAMES	0	G
TOTAL TIME	0D 0H 0M 0S	H
PLAY TIME	0D 0H 0M 0S	I
AVERAGE PLAY TIME	0H 0M 0S	
LONGEST PLAY TIME	0H 0M 0S	
SHORTEST PLAY TIME	0H 0M 0S	

PRESS TEST BUTTON TO CONTINUE

1. Press the Test Button to proceed to the next page (Time Histograms screen).

(A) COIN CHUTE #1 and #2

Displays the number of coins inserted in COIN CHUTE #1 or #2. From the front of the cabinet, the left-hand side coin chute is Chute #1, and the right-hand side coin chute is Chute #2.

(B) TOTAL COINS

Total number of times both the COIN CHUTES have been actuated.

(C) COIN CREDITS

Number of CREDITS registered by COIN insertion only.

(D) SERVICE CREDITS

Credits registered by Service Button usage.

(E) TOTAL CREDITS

Total number of CREDITS registered (COIN CREDITS + SERVICE CREDITS).

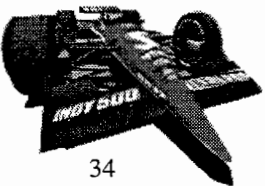

(F) NUMBER OF GAMES

Total number of games played.

(G) TOTAL TIME

Time available for play (excludes time in Test Mode).

(H) GAME PLAY TIME

Total time games were being played (part of the TOTAL TIME; remainder of TOTAL TIME is spent in ATTRACT MODE).

(I) AVERAGE GAME TIME

The GAME PLAY TIME divided by the NUMBER OF GAMES.

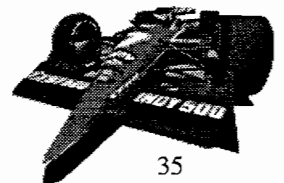

TIME HISTOGRAM

Count of the length of each game played in 30 second intervals.

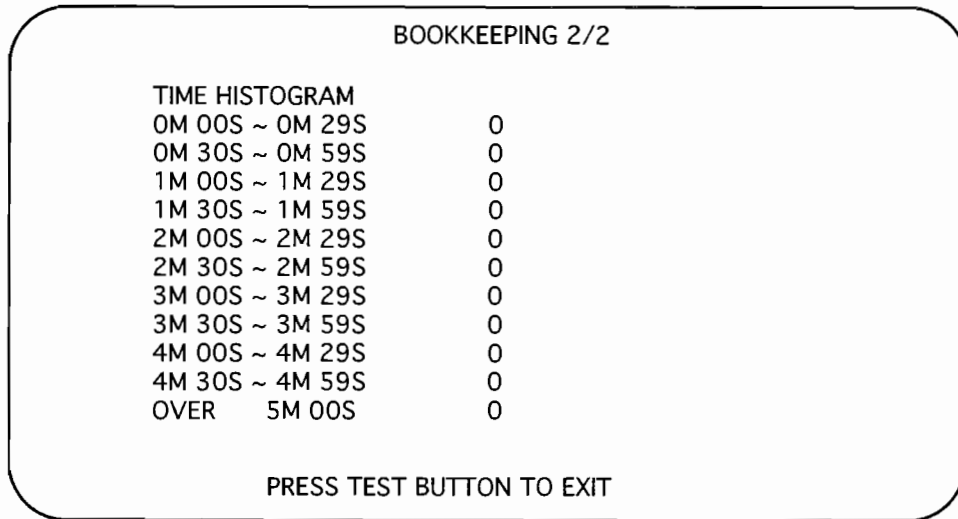

1. Press the Test Button to return to the Test Menu.

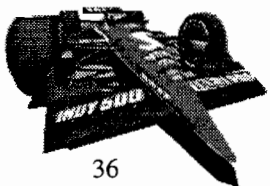

BACKUP DATA CLEAR

Clear the contents of BOOKKEEPING. Does not affect the Game Assignment settings.

BACKUP DATA CLEAR

YES	(CLEAR)
⇨ NO	(CANCEL)

SELECT WITH SERVICE BUTTON
AND PRESS TEST BUTTON

1. When clearing, bring the cursor ⇨ to YES; and when not clearing, to NO, by using the Service Button, and then pushing the Test Button.
2. When clearing is finished, "COMPLETED" will be displayed.
3. Press the Test Button to return to the Test Menu.

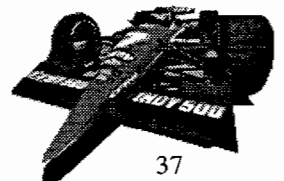

PERIODIC CHECK

The periodic check and maintenance of the items listed in Table 14 is suggested to retain the performance of this machine and to ensure safe operation.

TABLE 14: PERIODIC CHECK AND MAINTENANCE ITEMS

<i>ASSEMBLY</i>	<i>ACTION ITEM</i>	<i>INTERVAL</i>
CONTROL	Check Button lamps	Monthly
	Check VOLUME VALUE	Monthly
	Check ADJUST GEAR	Monthly
	Check GEAR GREASING	Monthly
	Check BEARING	Monthly
OVER/UNDER COIN DOOR ASSEMBLY	Check COIN SWITCH	Monthly
	Clean COIN SELECTOR	Tri-Monthly
MONITOR	Check ADJUSTMENTS	Monthly
GAME BOARD	Run MEMORY TEST	Monthly
INTERIOR	CLEAN	Annually
POWER SUPPLY PLUG	CHECK and CLEAN	Annually
SEAT	Grease RAIL	Trimonthly

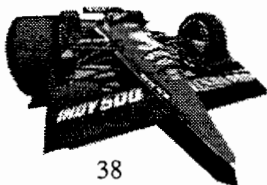

TROUBLESHOOTING

- The items listed in Table 15 will assist in troubleshooting when a problem occurs. As a first step, check all wiring connector connections and verify AC power to the machine.

TABLE 15: TROUBLESHOOTING GUIDE

PROBLEMS	CAUSE	COUNTERMEASURES
When the main SW is turned ON, the machine is not activated.	The cord is not plugged in. Power switch is off. Incorrect power source/voltage. Fuse is blown.	Firmly insert the plug into the outlet. Turn on the cabinet. Make sure that the power supply voltages are correct. First, remove the cause of overcurrent and replace the fuse. Fuse: 12A 250V Slo Blo.
MONITOR screen is blackened and the fluorescent lamp does not light up.	Fuse is blown.	First remove the cause of overcurrent, then replace the fuse. Fuse: 12A 250V Slo Blo.
The color of image on MONITOR screen is incorrect.	Defective connections between boards.	Make sure of correct connections between boards.
The on-screen image of the monitor sways and/or shrinks.	Incorrect monitor adjustment. The power source and voltage are not correct.	Make appropriate adjustments Make sure that the power supply and voltage are correct.
Control panel controls are not operating satisfactorily.	Controls or Button microswitches malfunctioning. Power-on check not performed properly.	Adjust or replace microswitches. Turn off unit and turn on again. Allow power-on check to complete.
Fluorescent lamps don't light up.	Fluorescent lamps need replacement. The connector is disconnected.	Replace the fluorescent lamp. Check connector connections in the billboard.
Sound is not emitted.	Fuse is blown. Sound volume adjustment is not correct.	Replace fuse: 12A 250V Slo Blo. Adjust the Service Panel's volume control knob.
Game makes sounds, but has no picture.	Malfunctioning of sound board and/or memory.	Perform the SOUND TEST.
Interactive play is not working.	Linking cable is disconnected. Linking cable connections are incorrect. Game settings for linked play are not correct.	Connect the cable. Connect the cable correctly - see Machine Options: Linking Instructions section. Reset the Game Assignments - see Machine Options: Linking Instructions section.

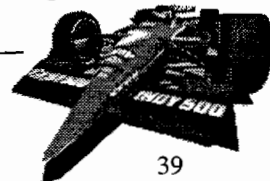

MACHINE OPTIONS

LINKING INSTRUCTIONS

This machine can be linked to similar machines to allow up to eight (8) people (four Indy 500 Twin cabinet sets) to race on the same course. Setting up LINKING requires modifications to the Assembly, Game Assignment and Network Assignments Settings, and Playing Instructions, as described in the following three sections.

ASSEMBLY

1. Due to the length of the fiber optic communications cables, connected machines must be located within 12 feet of each other.
2. For four players, link the machines as shown in Figure 23 (four players), using the fiber optic cable found coiled inside each machine's Cash Box Tower.
3. The user only connects the external fiber optic cabling. The internal cabling is configured at the factory.
4. The cable and machine linking connectors are keyed so that they can only be connected when the longest flat side of the cable connector is facing up (see Figure 22).
5. At the center rear of the MASTER machine (cabinets 1 and 2), insert the black end of the linking cable into the TX connector and the red end into the RX connector.
6. To link additional machines, add SLAVE machines (cabinets 3,4,5,6,7, and 8), connecting TX outputs to RX inputs, as shown in Figure 24 (six players) and Figure 25 (eight players).
7. Loop and tuck the excess fiber optic cable between the left- and right-side cabinets. Do not bend the fiber optic cable.
8. Apply Seat Number stickers to back of each seat, starting from the left-side cabinet of the MASTER cabinet and proceeding to the right (see Figure 26).

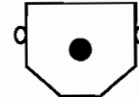

FIGURE 22: FIBER OPTIC CABLE CONNECTOR

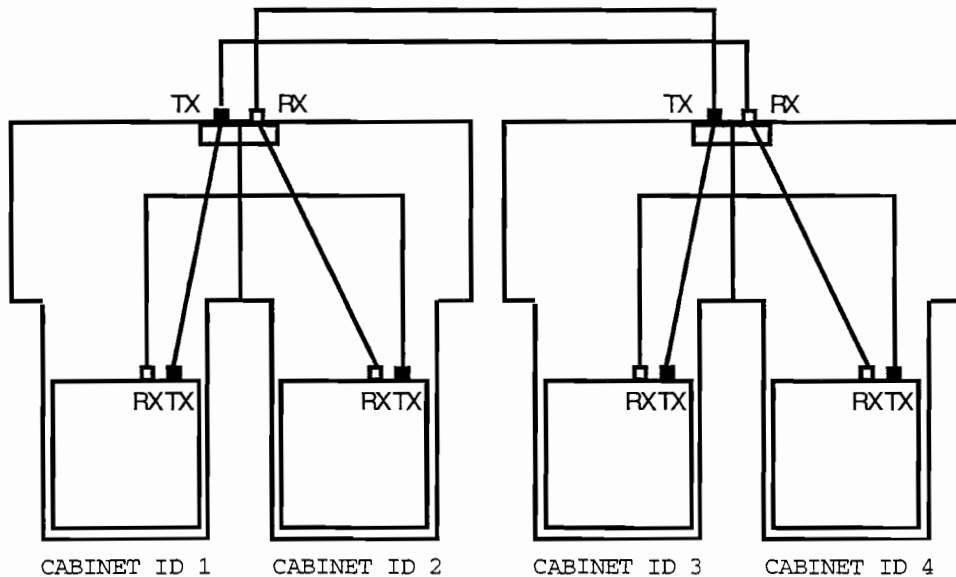
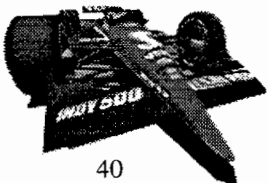

FIGURE 23: FOUR PLAYER LINKING DIAGRAM



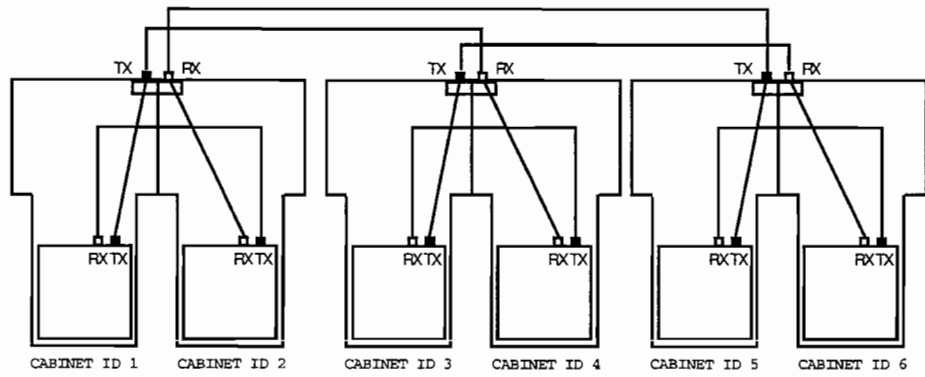

FIGURE 24: SIX PLAYER LINKING DIAGRAM

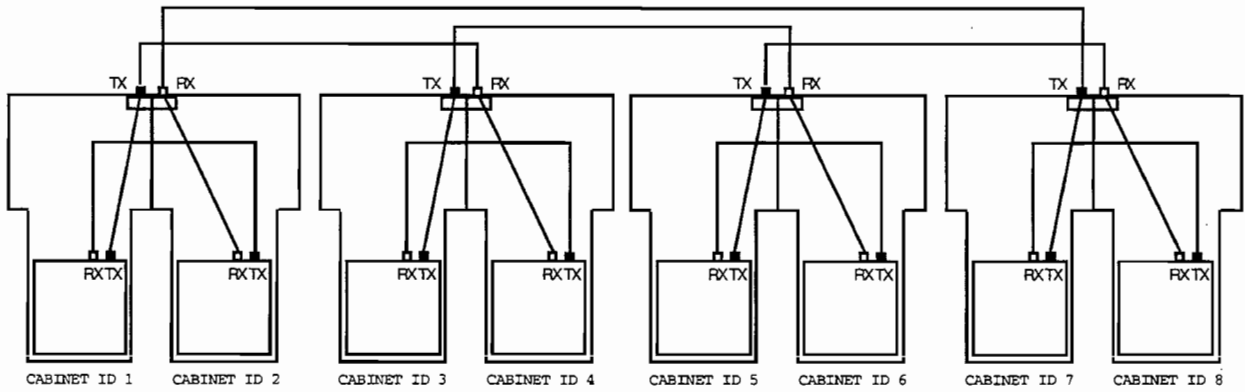

FIGURE 25: EIGHT PLAYER LINKING DIAGRAM

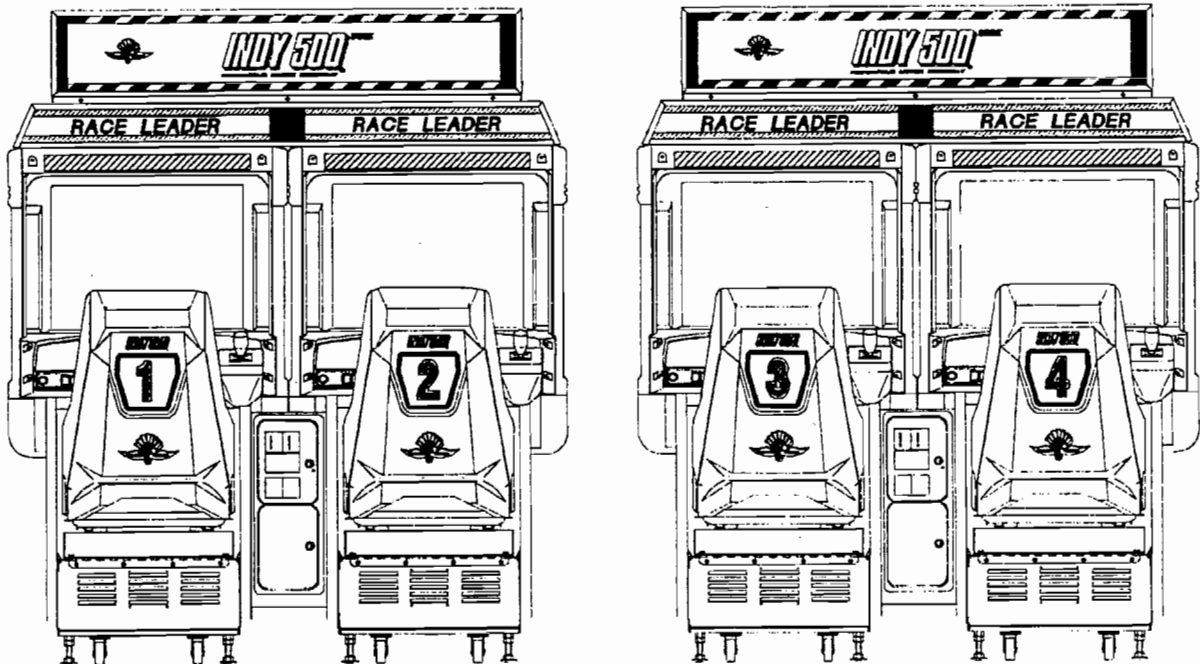
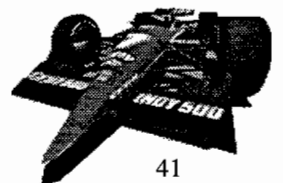

FIGURE 26: SEAT NUMBERING DIAGRAM



GAME SYSTEM SETTINGS

For each linked cabinet, press the Test Button on the Service Panel and modify the Network Assignments menu as shown below. When changing settings, refer to the Test Mode section.

1. Press the Test Button to enter the Test menu and choose NETWORK ASSIGNMENTS (see Figure 27).
2. Bring the cursor ⇄ to COMMUNICATION and press the Test Button to select NETWORK (see Figure 28).
3. Move the cursor ⇄ to PRIVILEGE MODE and press the Test Button to allow one of the cabinets to be set to MASTER. Set all other cabinets to SLAVE.
4. Bring the cursor ⇄ to CABINET ID NUMBER, press the Test Button, and set the machine numbers sequentially (1, 2, 3, ... 8) as applicable, starting from the extreme left cabinet, facing the front of the monitors (matching the seat numbers). If the same number is set for two or more cabinets, or if the sequential order is incorrect, the game display will be confused.
5. In the case of linked play, the Game Assignments settings are made on the MASTER cabinet. Even if the settings are changed on the SLAVE machines, the settings will not be effective. Changing the settings on the MASTER cabinet causes all of the SLAVE machines to change the to MASTER unit's settings.
6. All linked machines perform a NETWORK CHECK (see Figure 29) when the power is turned on, and when exiting the Test Menu. Linked play is not possible unless all of the linked machines simultaneously perform a NETWORK CHECK. Should testing become necessary for one machine, all of the remaining machines will be tested. When testing is finished for the machine which required testing, all of the machines will exit from the Test Menu at the same time.

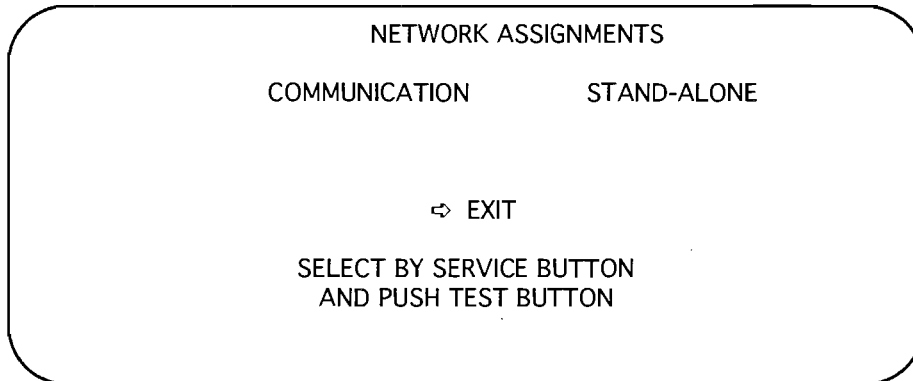

FIGURE 27: NETWORK ASSIGNMENTS SCREEN – STAND-ALONE MODE

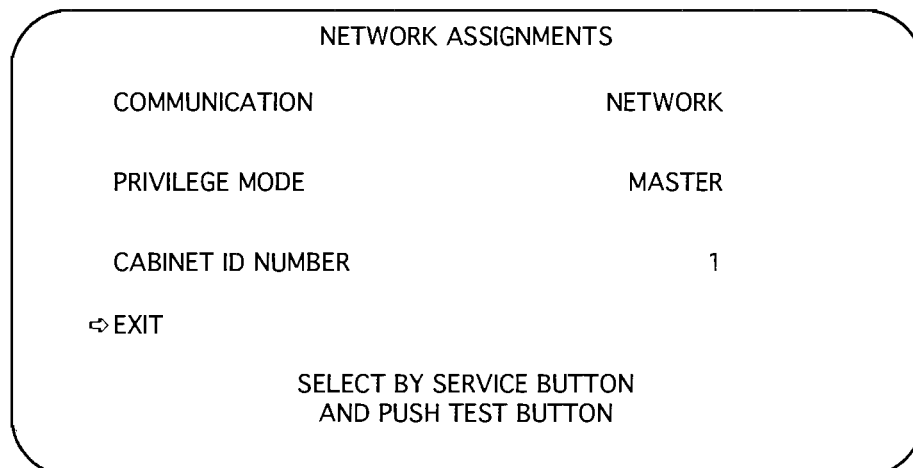
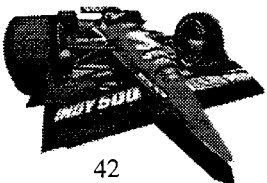

FIGURE 28: NETWORK ASSIGNMENTS SCREEN – LINKED MASTER CABINET



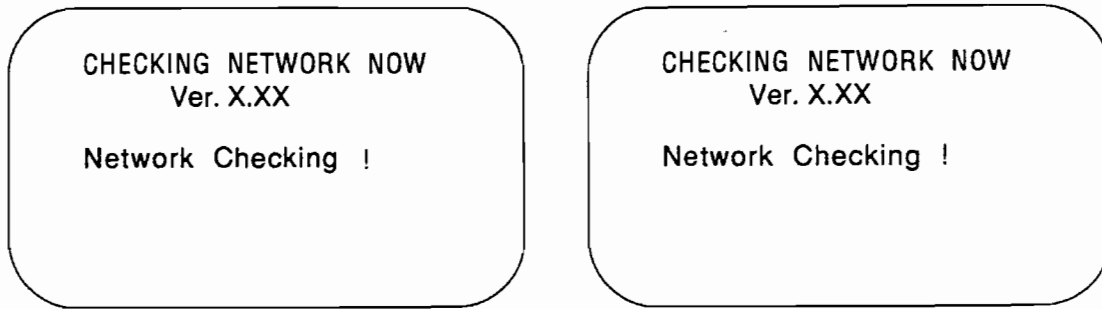
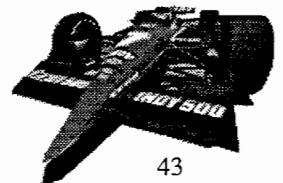

FIGURE 29: NETWORK CHECKING SCREENS

PLAYING INSTRUCTIONS

Most of the instructions in the HOW TO PLAY section apply to linked or unlinked machines, with the following exceptions:

1. The player at the MASTER machine should insert a coin first, and press the start button. A message "WAITING FOR YOUR ENTRY" will appear on the remaining linked machine's monitors.
2. Within 14 seconds, each linked machine player who desires to compete must insert a coin in their coin slot.
3. Each player should select the course that they wish to compete on. Ties will be decided as discussed in the How To Play section.
4. Shift selection is made independently on each machine.
5. After AUTO or MANUAL shift has been selected, the race begins.



PARTS LIST

INDY 500 TWIN GRAPHICS

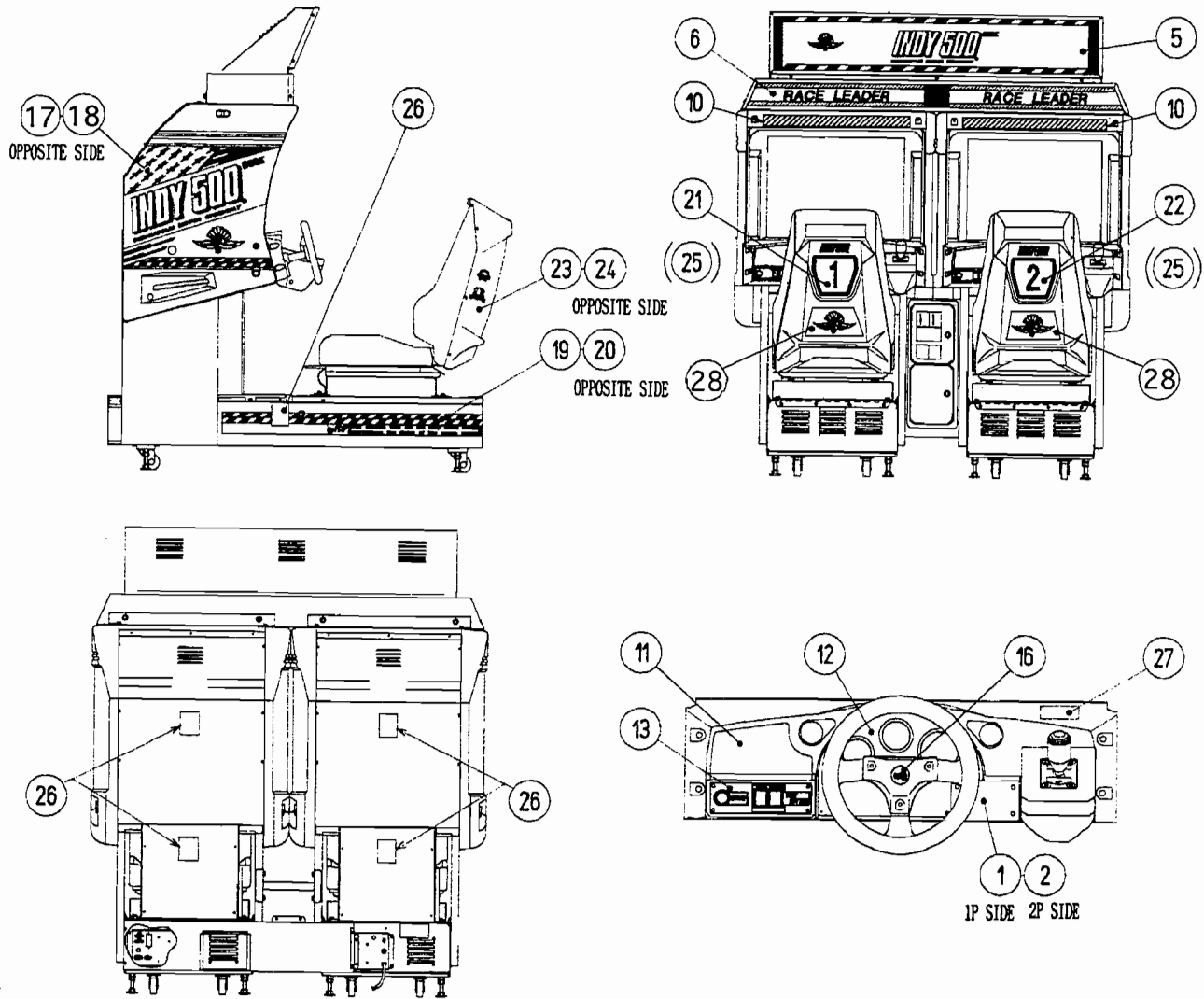
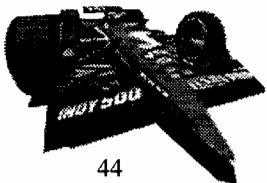

FIGURE 30: INDY 500 TWIN GRAPHICS



INDY 500 TWIN GRAPHICS

Table 16: Indy 500 Twin Graphics Parts List

<u>NO.</u>	<u>PART NO.</u>	<u>DESCRIPTION</u>
1	DYN-0010	DENOMI PLATE
2	DYN-0011	DENOMI PLATE W/O ORIGINAL
5	4230-0250	BILLBOARD PLATE UPPER
6	4231-0251	BILLBOARD PLATE LOWER
10	4220-0537-01	SUB INSTR SH INDY
11	4220-0540-01	PLAY INSTR SH INY TWIN
12	421-8768	STICKER METER PANEL
13	INY-1251-B	SHEET VR SW
16	INY-1203-B	SHEET EMBLEM
17	Silkscreen on panel	STICKER SIDE 1P L
18	Silkscreen on panel	STICKER SIDE 2P R
19	INY0-2001-B	STICKER BASE L
20	INY0-2001-C	STICKER BASE R
21	INY1-1604-B	STICKER 1P
22	INY1-1607-A	STICKER 2P
23	INY1-1604-C	STICKER SEAT L
24	INY1-1604-D	STICKER SEAT R
25	4210-8935	STICKER INDY CAR No. "2-8" (for use with linked machines)
26	4400-WS0002-EG	STICKER "POWER OFF"
27	4400-CS0011-EG	STICKER "GRIP HANDLE"
28	999-0505	STICKER SEAT LOWER

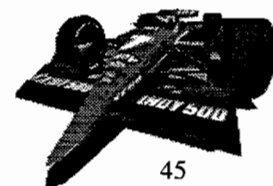

INDY 500 TWIN ASSEMBLY P/N INY-00001

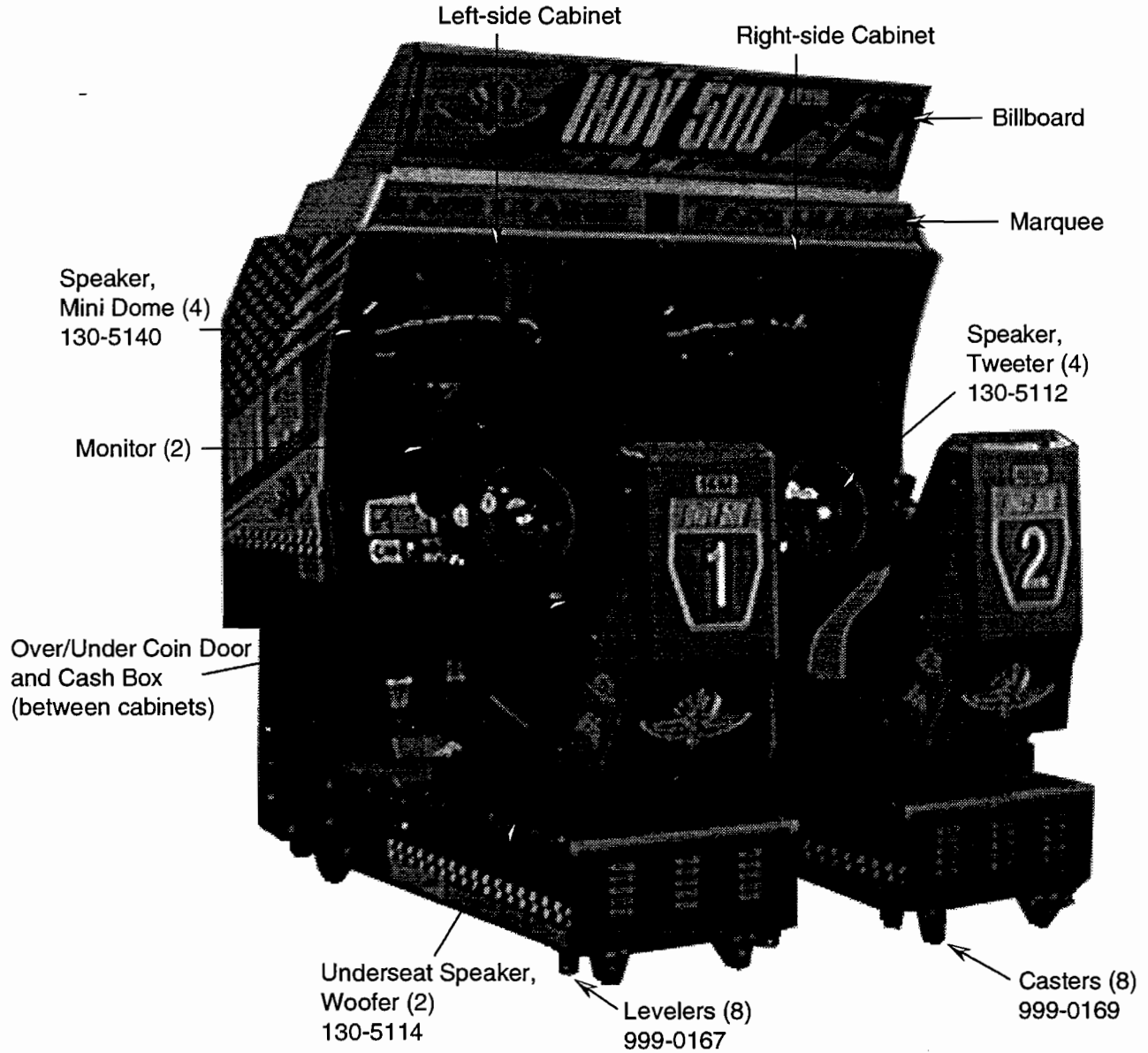
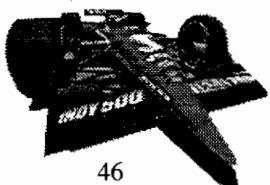

FIGURE 31: INDY 500 TWIN CABINET ASSEMBLY



BILLBOARD ASSEMBLY P/N INY1-0200

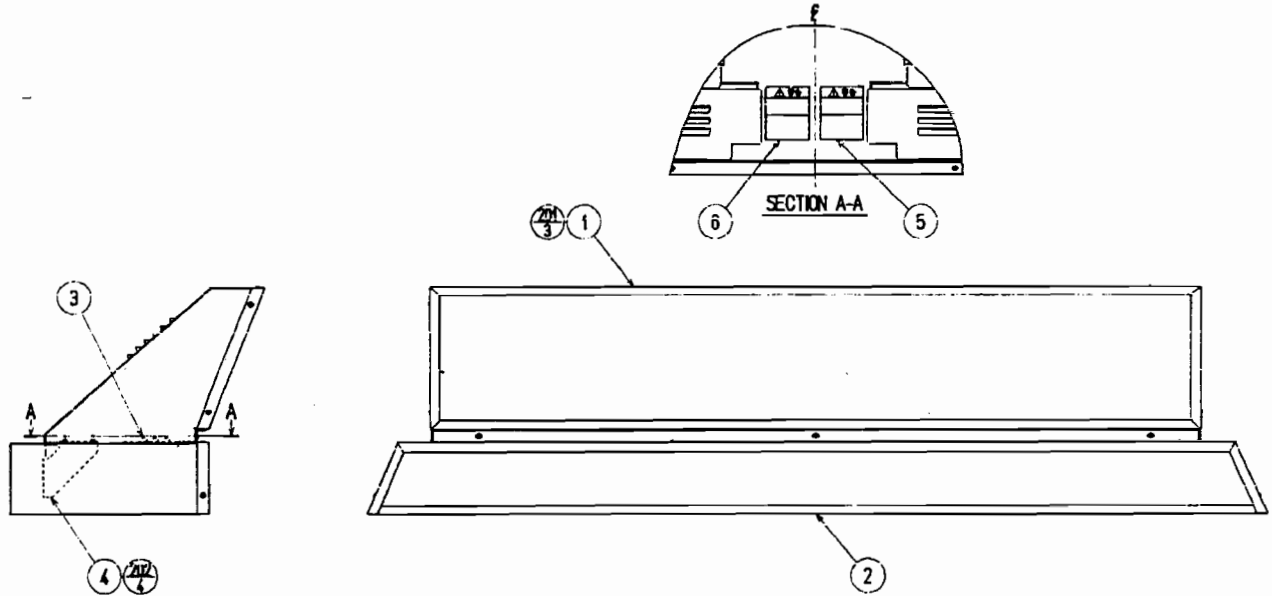
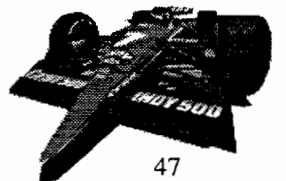

FIGURE 32: BILLBOARD ASSEMBLY

Table 17: Billboard Parts List

<u>NO.</u>	<u>PART NO.</u>	<u>DESCRIPTION</u>
1	INY1-0210	ASSY BILLBOARD UPPER
2	INY1-0220	ASSY BILLBOARD LOWER
3	RAL1-0201	LAMP LID
4	RAL1-0202	STAY BRKT



BILLBOARD UPPER ASSEMBLY P/N INY1-0210

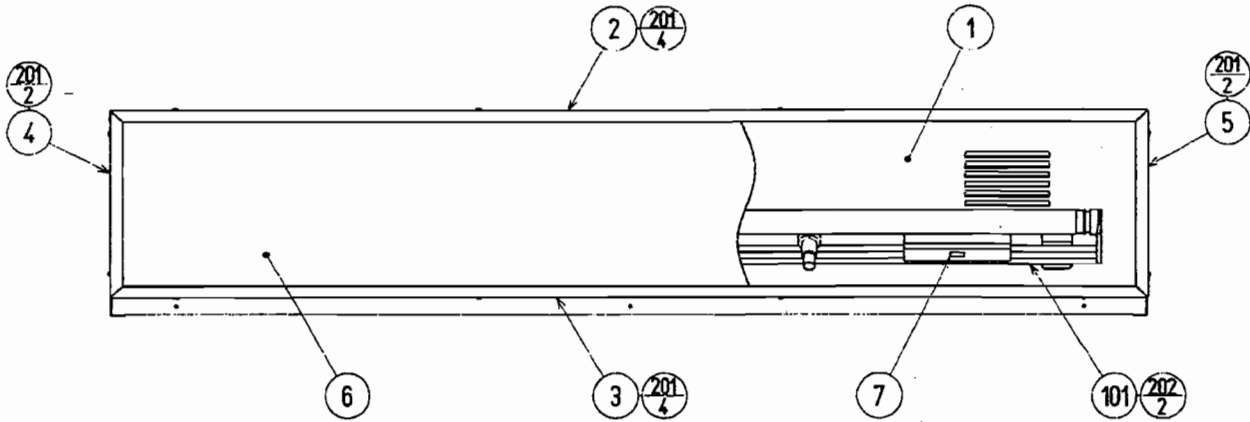
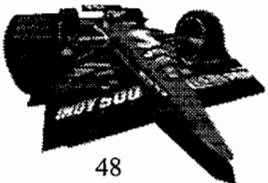

FIGURE 33: BILLBOARD UPPER ASSEMBLY

Table 18: Billboard Upper Parts List

<u>NO.</u>	<u>PART NO.</u>	<u>DESCRIPTION</u>
1	RAL1-0211	BILLBOARD CASE UPPER
2	RAL1-0212	CORNER EDGE UPPER
3	RAL1-0213	CORNER EDGE LOWER
4	RAL1-0214	CORNER EDGE LEFT
5	RAL1-0215	CORNER EDGE RIGHT
6	4230-0250	BILLBOARD PLATE UPPER
7		STICKER FL 40W
101		ASSY FL 40W EX W/CONN HIGH
102		CORD CLAMP Ø21



BILLBOARD LOWER ASSEMBLY P/N INY1-0220

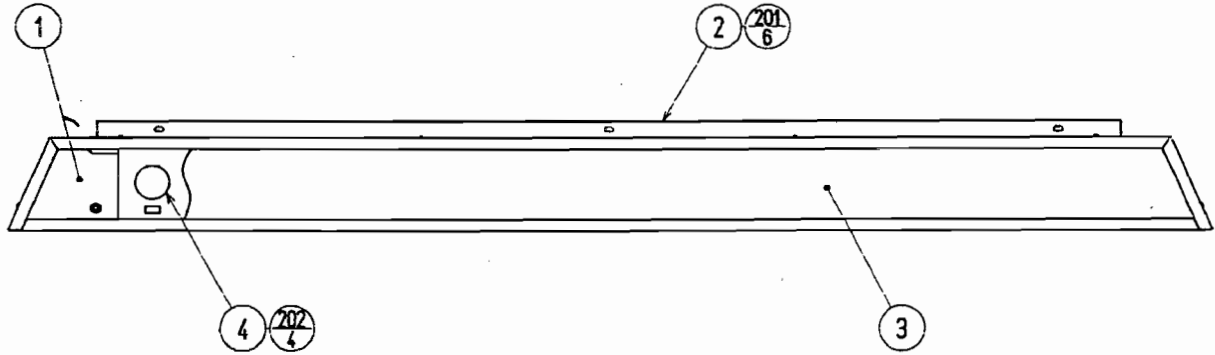
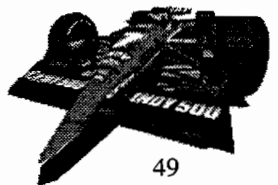

FIGURE 34: BILLBOARD LOWER ASSEMBLY

Table 19: Billboard Lower Parts List

<u>NO.</u>	<u>PART NO.</u>	<u>DESCRIPTION</u>
1	RAL1-0221	BILLBOARD CASE LOWER
2	RAL1-0222	CORNER EDGE
3	4231-0251	BILLBOARD PLATE LOWER
4	RAL1-0230	LAMP UNIT
101		CORD CLAMP Ø21



LAMP ASSEMBLY P/N RAL1-0230

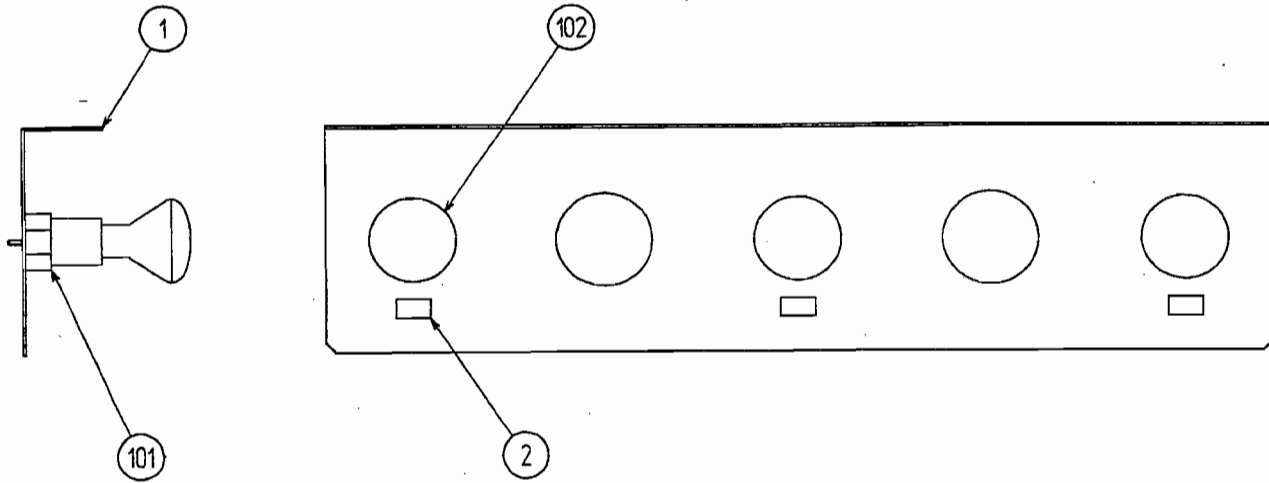
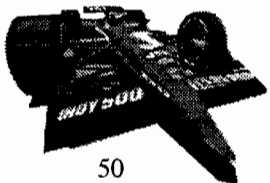

FIGURE 35: LAMP ASSEMBLY

Table 20: Billboard Lower Parts List

<u>NO.</u>	<u>PART NO.</u>	<u>DESCRIPTION</u>
1	RAL1-0231	LAMP PANEL
2		STICKER 110V 30W
101		BULB SOCKET
101		LAMP 110V 30W
101		PLASTIC TIE BELT 110MM
104		CORD CLAMP Ø10



CONTROL PANEL ASSEMBLY P/N INY1-12002

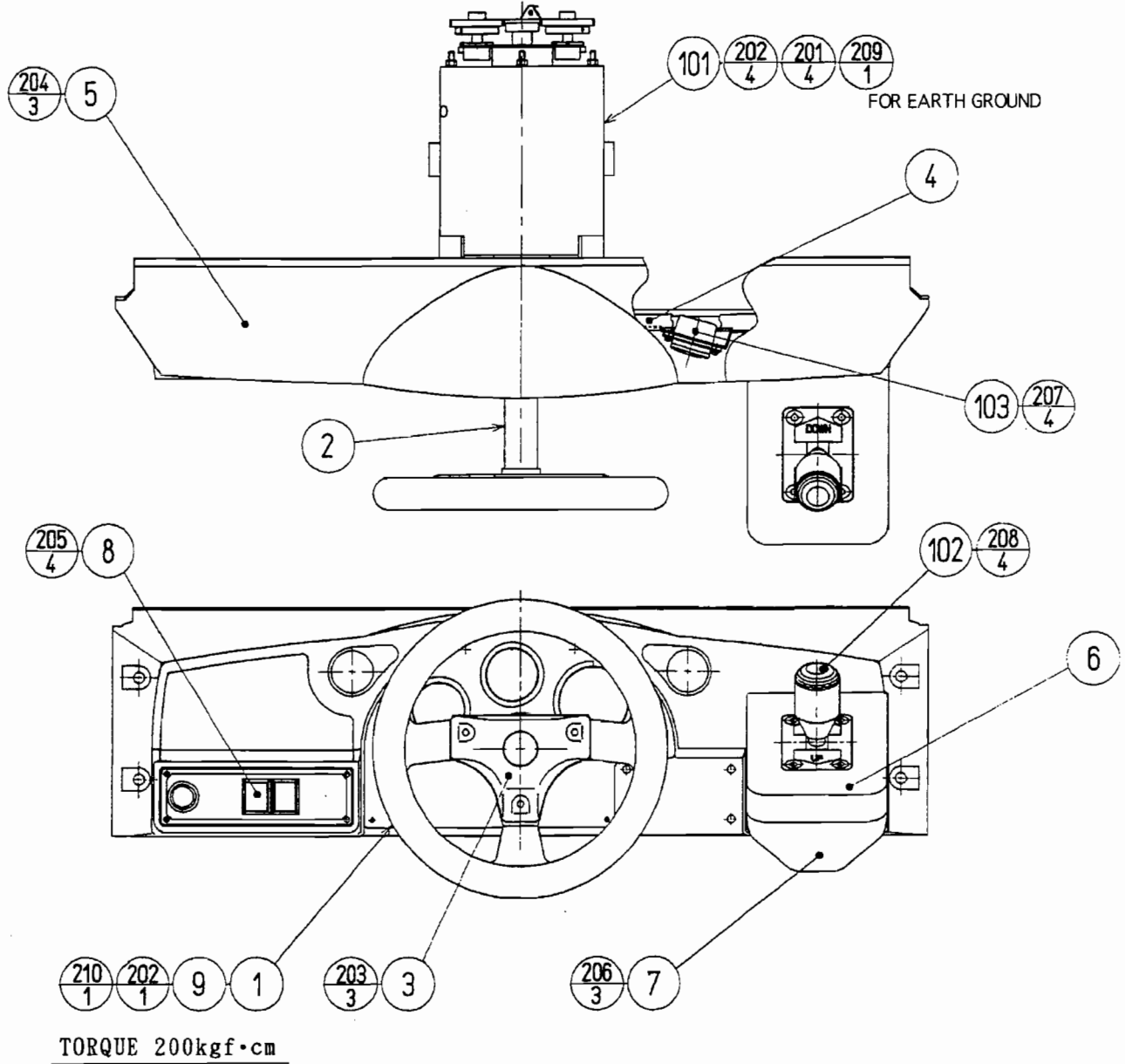
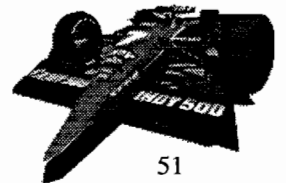

FIGURE 36: CONTROL PANEL ASSEMBLY



CONTROL PANEL ASSEMBLY P/N INY1-12002

Table 17: Control Panel Parts List

<u>NO.</u>	<u>PART NO.</u>	<u>DESCRIPTION</u>
1	DYN-1201	STEERING WHEEL
2	DYN-1209	HANDLE COLLAR
3	INY-1203	STEERING EMBLEM
4	INY1-1205	CONTROL PANEL BRACKET
5	INY-1206-01	CONTROL PANEL COVER
6	INY-1204	SHIFT COVER INDY
7	DYN-1223	SHIFT COVER B
8	INY-1250	ASSY VIRTUAL BUTTON
9	OUT-2026	SPACER
101	610-0383	ASSY HANDLE MECHANISM W/MOTOR
102	6100-0384	UP/DOWN SHIFTER
103	130-5112	TWEETER 8 OHM 2W Ø35
104	601-0460	PLASTIC TIE BELT 100MM
105	280-5009	CORD CLAMP Ø21
201	060-S00800	SPR WSHR M8
202	999-0418	NUT NYLOC M8
203	008-T00512-0B	TMP PRF SCR TH BLK M5 x 12
204	000-T00416	M SCR TH M4 X 16
205	000-T00416-0C	M SCR TH CRM M4 X 16
206	000-P00412-W	M SCR TH W/FS M4 X 12
207		SCR 4-40 X 1/4 SELF-TAPPING
208	008-T00516-0B	TMP PRF SCR TH BLK M5 X 16
209	050-F00400	FLG NUT M4
210	999-0419	FENDER WASHER

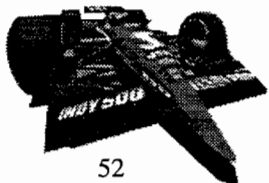

START AND VIEW BUTTON ASSEMBLY P/N INY-1250

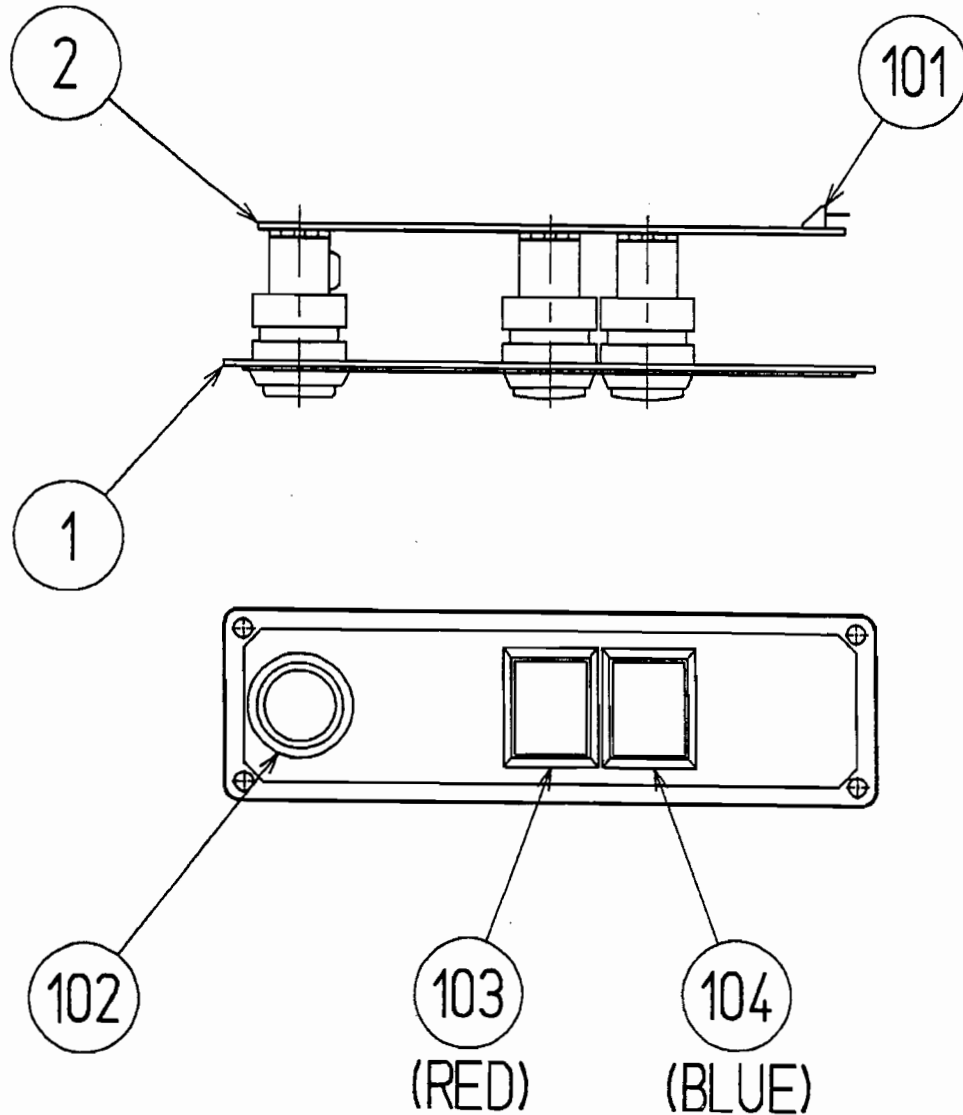
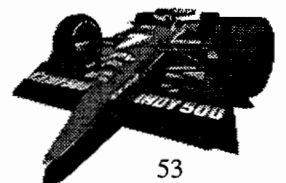

FIGURE 37: START AND VIEW BUTTON ASSEMBLY

Table 18: Start and View Button Parts List

NO.	PART NO.	DESCRIPTION
1	INY-1251	VR SW BRACKET
2	171-6478B	PC BD LIGHTING SWX5
101	212-5205-12	CONN JST M 12P RTA
102	509-5560-Y	PB SW W/L 6V 1L Y
103	509-5561-R	PB SW W/L 6V 5L R
104	509-5561-S	PB SW W/L 6V 5L S



SHIFTER ASSEMBLY P/N 6100-0384

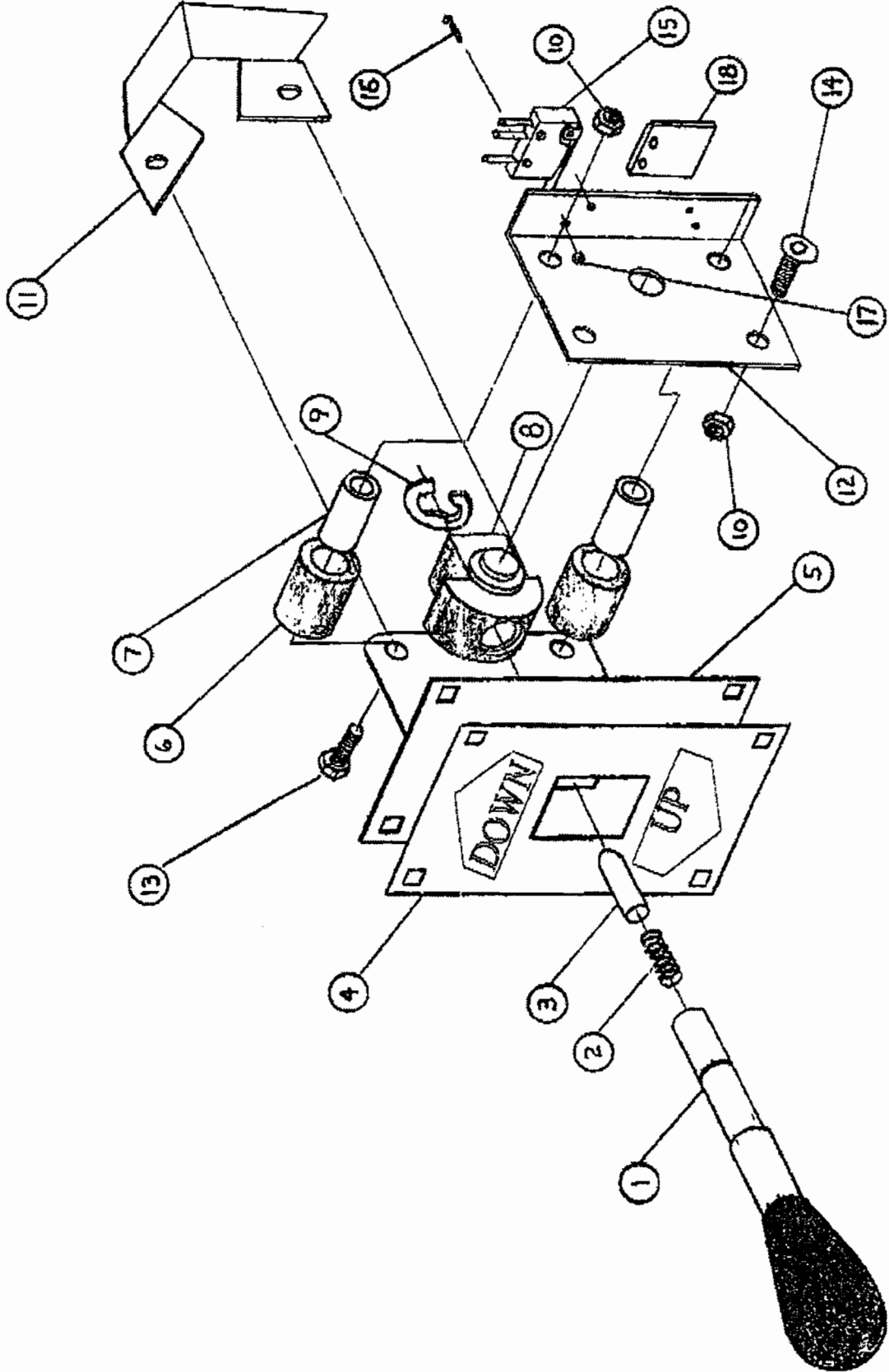
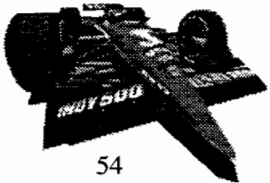

FIGURE 38: SHIFTER ASSEMBLY



SHIFTER ASSEMBLY P/N 6100-0384

Table 19: Shifter Parts List

<u>NO.</u>	<u>PART NO.</u>	<u>DESCRIPTION</u>
1	50-2981-00	KNOB AND SHAFT
2	50-2582-00	SPRING FOR SHAFT
3	50-8392-00	DELTRIN PIN
4	50-1027-02	SHIFTER PLATE
5	50-2983-00	BRACKET, LEFT SIDE
6	50-1031-00	RUBBER BUMPER (2)
7	50-2987-00	METAL SPACER FOR BUMPER (2)
8	50-2986-00	TRUNNION
9	50-8118-00	E-RING
10	43-0292-00	NUT, HEX NYLOCK M6 (4)
11	50-2985-00	BRACKET, RETURN TO CENTER
12	50-2984-00	BRACKET, RIGHT SIDE
13	43-0110-00	CAPSCREW, M6x40 HEX HD (2)
14	43-0415-00	CAPSCREW, M6x16 FLAT HD SOCKET (2)
15	95-4276-00	SWITCH ASSY. (2)
16	43-0368-00	SCREW, M2x12MM PHIL PAN HD (4)
17	43-0367-00	NUT, M2 HEX (4)
18	80-3001-00	FISH PAPER (2)

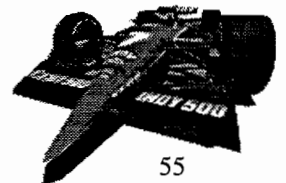

GAS AND BRAKE PEDAL ASSEMBLY P/N DYN1-1300

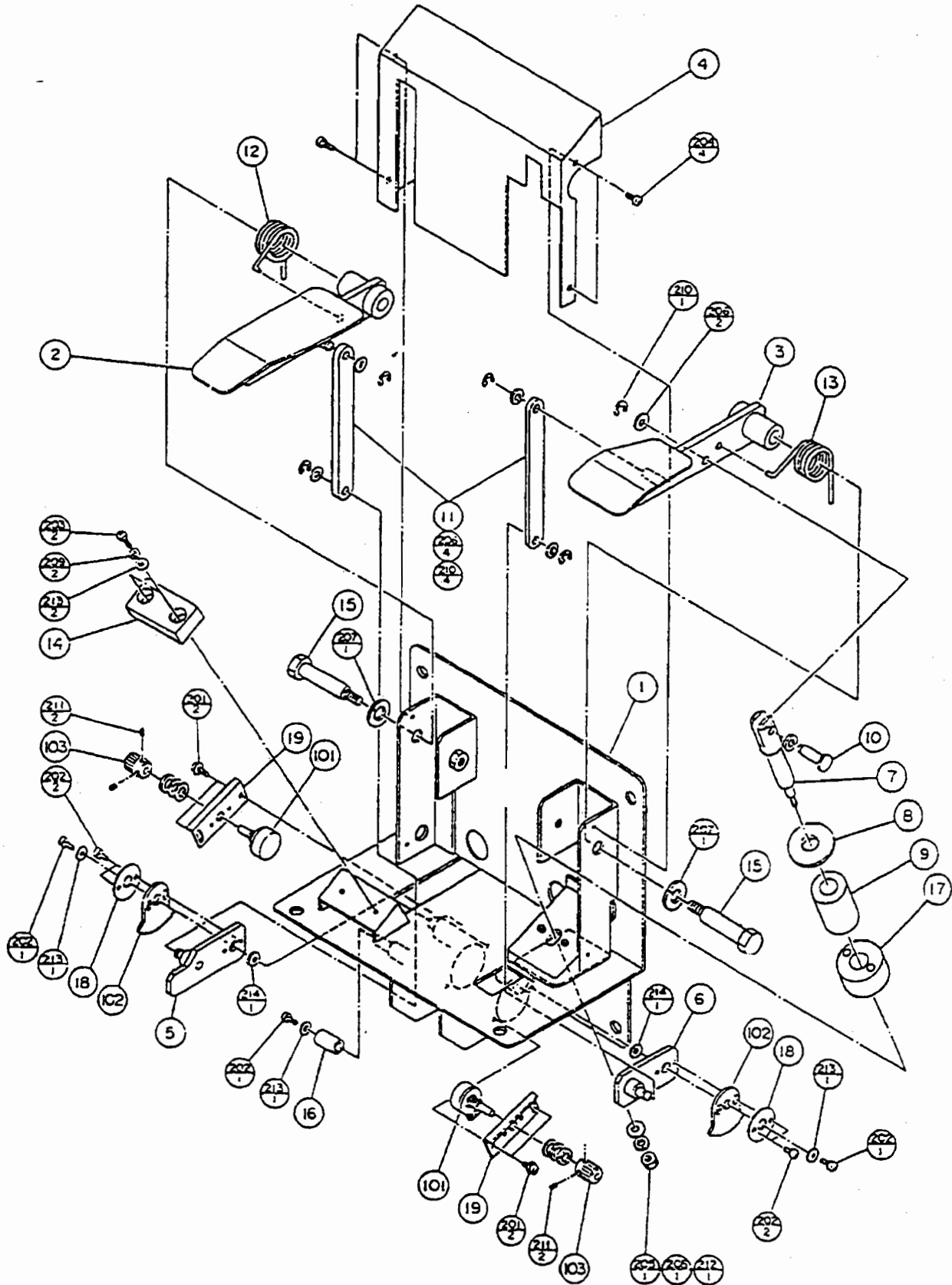
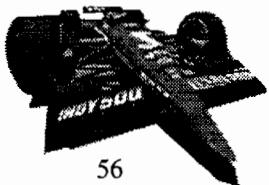

FIGURE 39: GAS AND BRAKE PEDAL ASSEMBLY



GAS AND BRAKE PEDAL ASSEMBLY P/N DYN1-1300

Table 20: Gas and Brake Pedal Parts List

<u>NO.</u>	<u>PART NO.</u>	<u>DESCRIPTION</u>
1	DYN1-1301	PEDAL BASE
2	BVG-1402	ACCEL PEDAL
3	BVG-1403	BRAKE PEDAL
4	BVG-1404	PEDAL COVER
5	BVG4-1405	SWING ARM A
6	BVG4-1406	SWING ARM B
7	BVG-1407	PUSH ROD
8	BVG-1408	PUSH PLATE
9	BVG-1418	RUBBER BUMPER
10	BVG-1410	PUSH ROD PIN
11	BVG-1411	LINK ROD
12	BVG-1412	TORSION SPRING ACCEL
13	BVG-1413	TORSION SPRING B
14	BVG-1414	RUBBER STOPPER
15	BVG1-1415	PEDAL SHAFT
16	BVG-1416	SWING ARM STOPPER
17	BVG-1417	SPACER
18	GLC-2122	GEAR PLATE
19	RDM-1210	VR BRACKET
101	220-5373	VOL CONT B - 5K OHM
102	601-6005	ADJUST GEAR
103	601-5943	GEAR 20 Ø 15
201		SCREW MS ZN 08-32 X 06 PH PN
203		SCREW MS BO 08-32 X 12 PH PN
205		NUT HEX M6
206	use 069-0000A	WASHER FL BO 11/16 X 11/32 X 3/32
207		WASHER SPLIT LOCK 13/16 X 1/2 X 3/32
208		WASHER SPLIT LOCK 1/4
209		WASHER SPLIT LOCK #8
210	use 065-E00600	E RING 05133-25
211		SET SCR 30 M3 X 06MM
212		WASHER FL 1/2 X 7/32 X 1/16
213		WASHER FL 30 #8
214	DYN-1305	FLT WASHER 12.2-22 X 0.5
215		E RING 05133-18

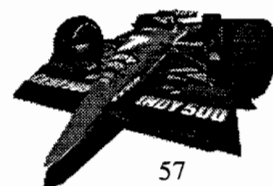

SEAT ASSEMBLY

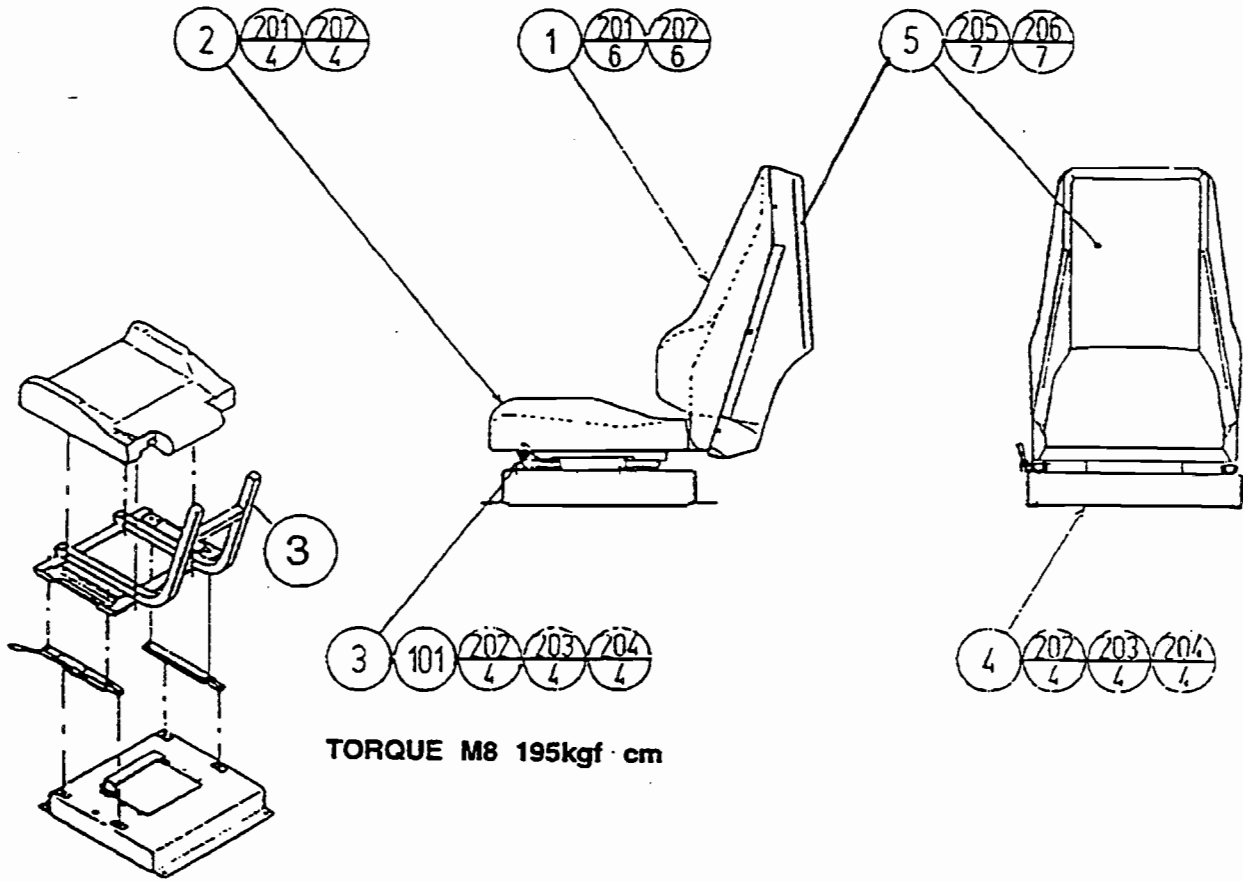
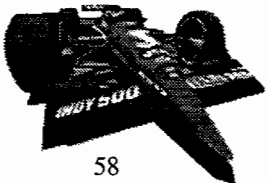

FIGURE 40: SEAT ASSEMBLY

Table 25: Seat Parts List

<u>NO.</u>	<u>PART NO.</u>	<u>DESCRIPTION</u>
1	INY0-1601	UPPER SEAT
2	INY0-1602	LOWER SEAT
3	DYN1-2081	SEAT FRAME TWIN
4	DYN1-2082	SEAT BASE
5	999-0506	SEAT BACK COVER
101	999-0443	SEAT RAIL SET



GAME BOARD SET

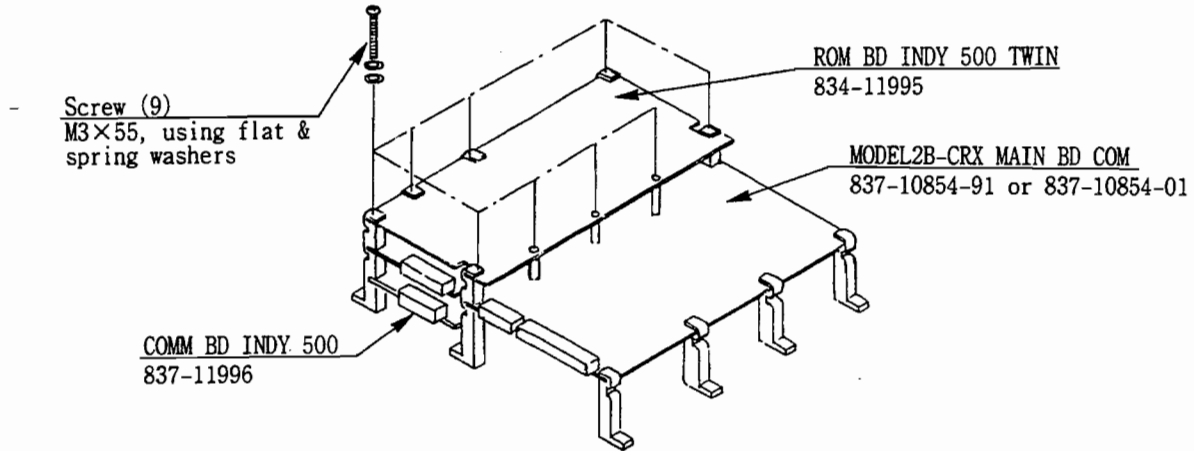

FIGURE 41: GAME BOARD SET ASSEMBLY

ROM BD INDY 500 TWIN (833 - 11995)

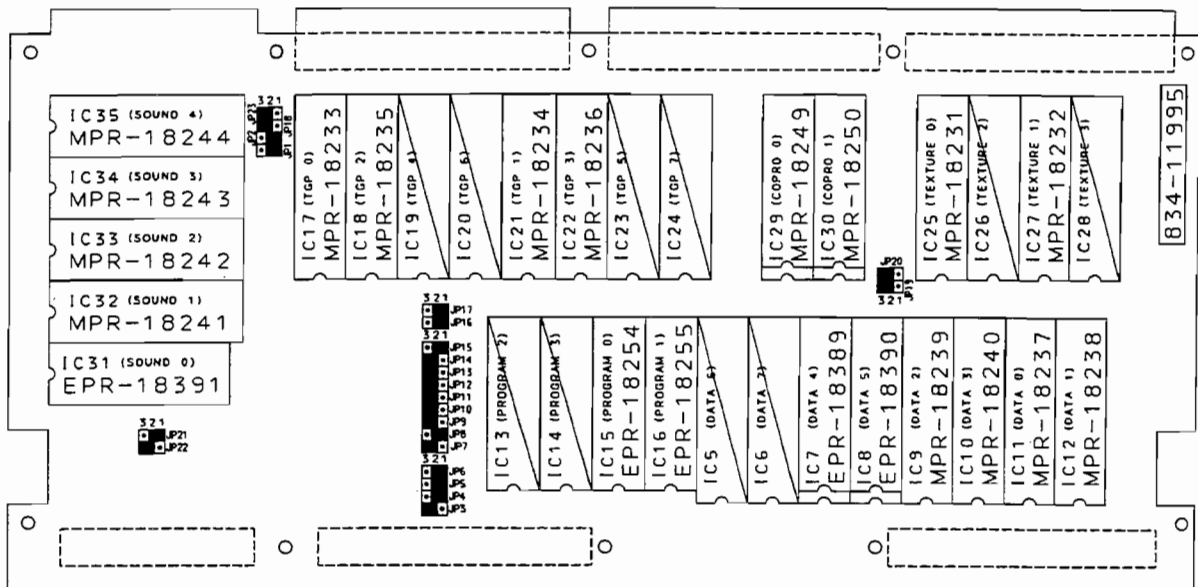

FIGURE 42: ROM BOARD

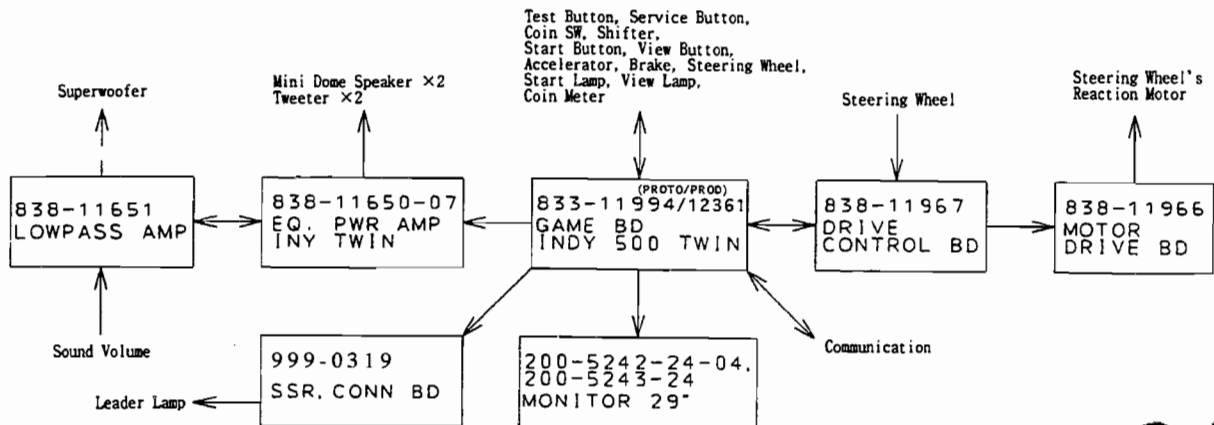
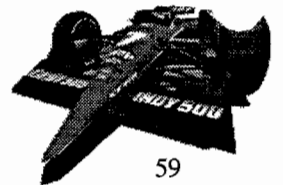
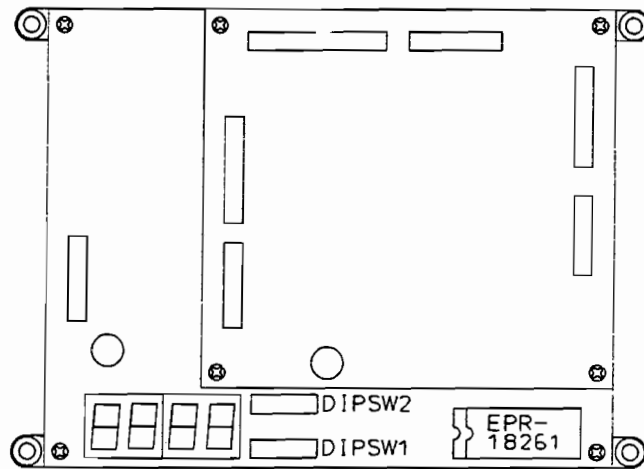

FIGURE 43: INDY 500 TWIN FLOW CHART



GAME BOARD SET



DRIVE CONTROL BD (838-11967)

FIGURE 44: DRIVE CONTROL BOARD

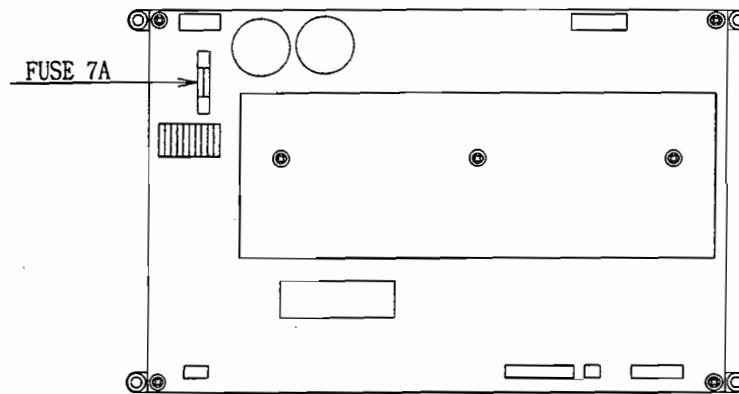

MOTOR DRIVE BD (838-11966)

FIGURE 45: MOTOR DRIVE BOARD

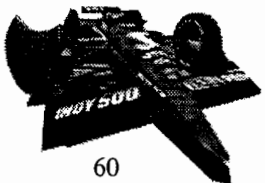

AC SECTION AND GAME BOARD ASSEMBLY

	Inter-Cabinet		
Power Supply	Linking Connectors		
999-0102			
150 W Switching XT		Game Board Case	Fan

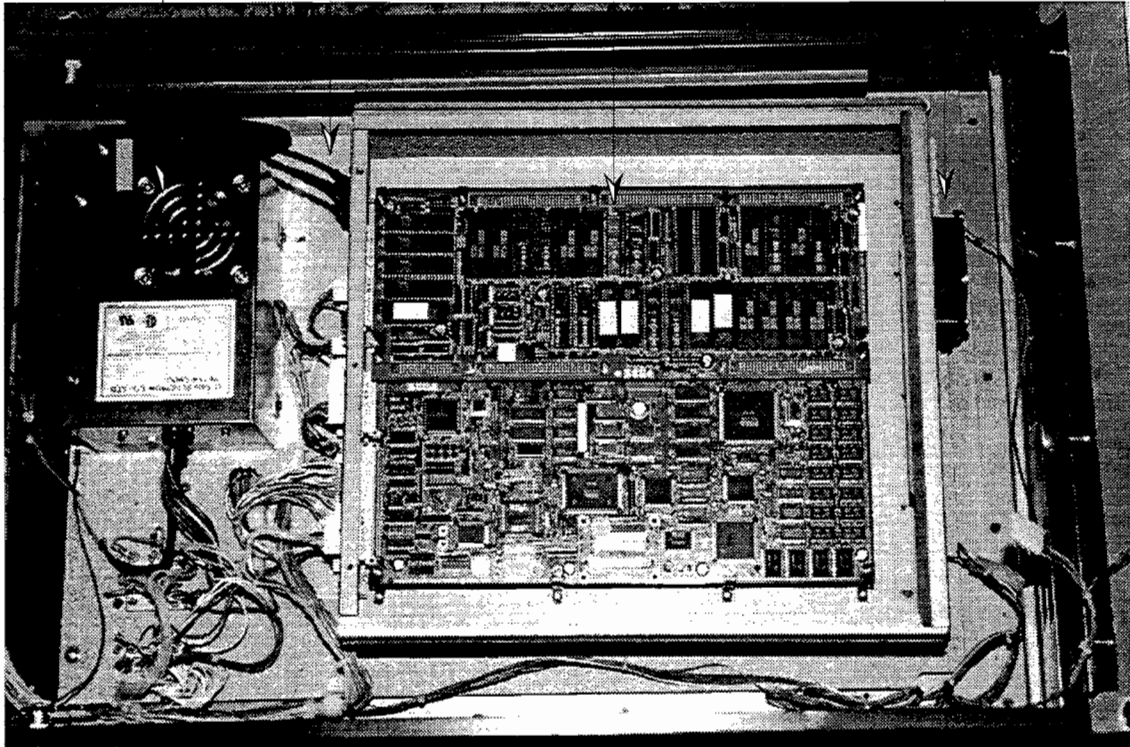

FIGURE 46: GAME BOARD, POWER SUPPLY AND FAN LOCATIONS - UNDER SEAT

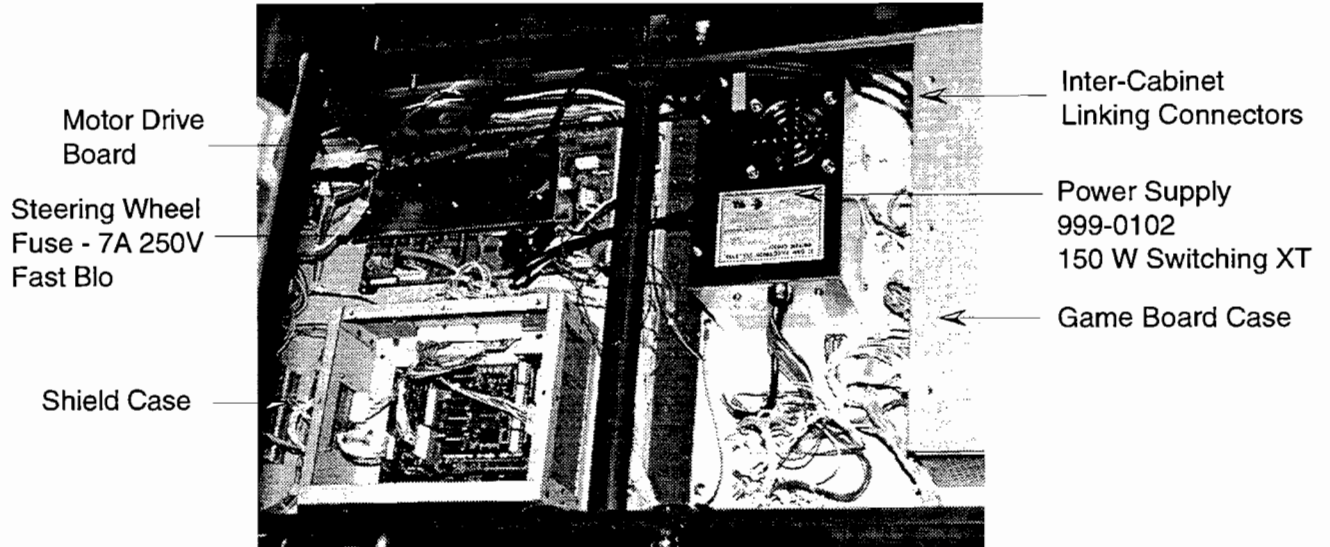
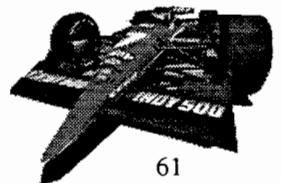

FIGURE 47: SHIELD CASE AND FUSE LOCATIONS - UNDER MIDDLE FLOORBOARD



AC SECTION AND GAME BOARD SET

AC Fuse
12 A 250 V
Slo Blo

Equilizer Board

Transformer
5601-5260
100 V 7 A
12.5 V 10 A

SSR

Shield Case

Motor Drive Board

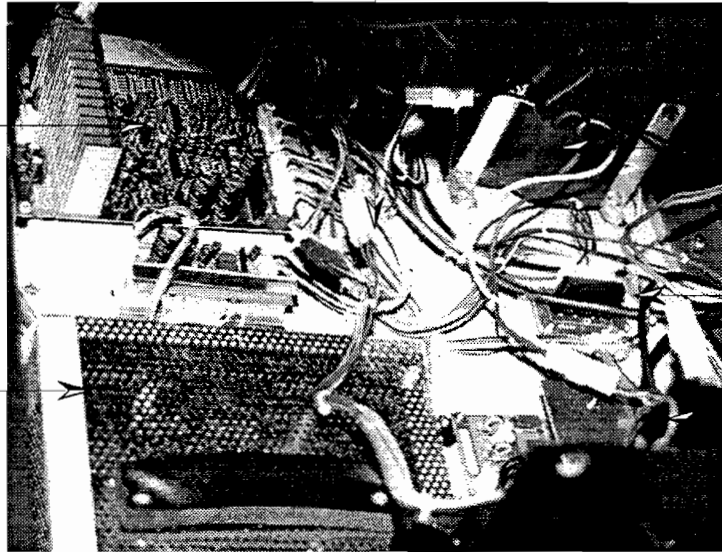
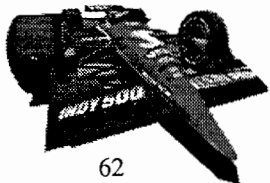

FIGURE 48: SHIELD CASE AND FUSE LOCATIONS - UNDER ACCELERATOR AND BRAKE FLOORBOARD



SERVICE INFORMATION

BILLBOARD LAMPS REPLACEMENT

1. Turn off the game at the power switch and unplug the Indy 500 Twin game.
2. Remove the three screws along the front edge of the Billboard between the Billboard and the Race Leader Marquee.
3. Tilt the Billboard top section open toward the rear, as shown in Figure 49.
4. The lamps are located as shown in Figure 49.
5. Replace the Billboard's fluorescent lamp with a 48 inch, 40 Watt fluorescent lamp.
6. Replace the Race Leader spot light(s) by lifting the Lamp Lid(s) and replacing the burned out bulb(s) with 110V, 30 Watt incandescent spot lamps.
7. Replace the Lamp Lid(s), if necessary
8. Tilt the Billboard top section back into place.
9. Replace the three screws back into the front edge.

CAUTION!

Use caution when removing lamps, they may be very hot.

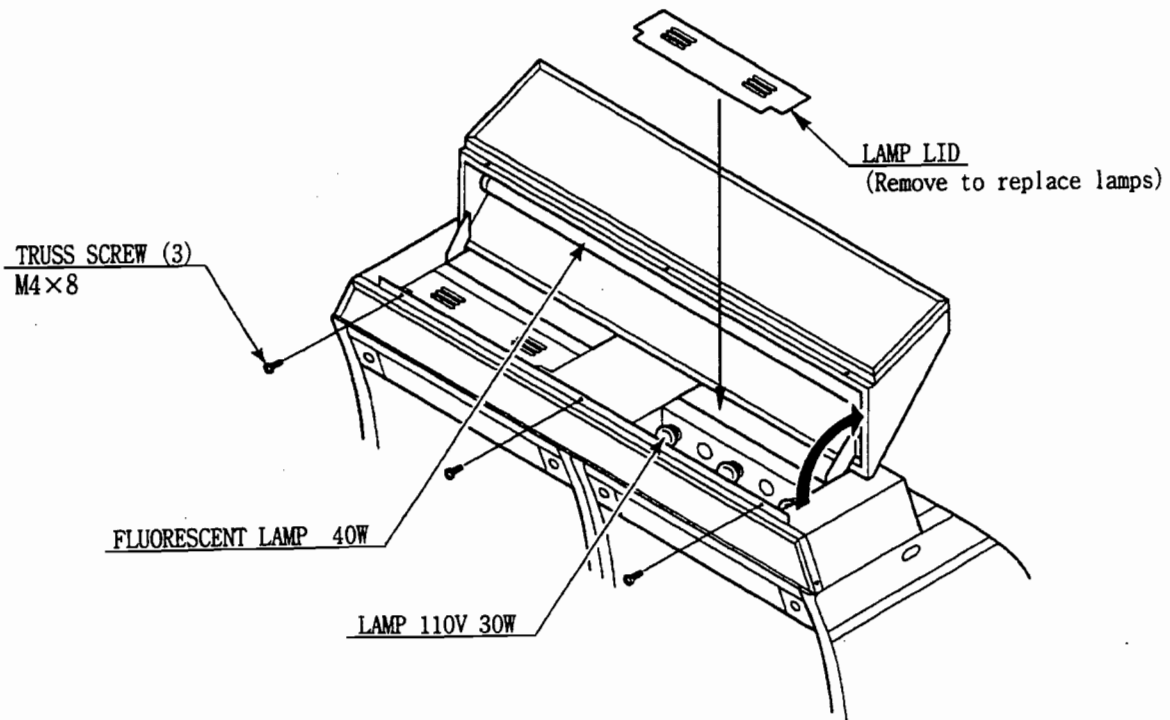
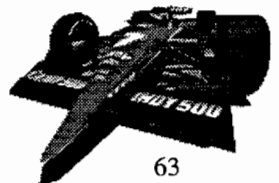

FIGURE 49: BILLBOARD LAMPS REPLACEMENT



MONITOR SERVICE

MONITOR SERVICE CAUTIONS

Before handling the monitors, be sure to read the following explanations and comply with the caution/warning instructions given below.



WARNING

Indicates that disregarding this warning may cause a potentially hazardous situation, which could result in death or serious injury.



CAUTION

Indicates that disregarding this caution may cause a potentially hazardous situation, which could result in personal injury and/or material damage.



Indicates that access to a specific part of the equipment is forbidden.



Indicates the instruction to disconnect a power connector or plug.



WARNING

- When performing such work as installing and removing the monitor, inserting and disconnecting the external connectors to and from monitor interior and the monitor, be sure to disconnect the power connector (plug) before starting the work. Proceeding the work without following this instruction can cause shock or malfunctioning.
- Using the monitor by converting it without obtaining a prior permission is not allowed. SEGA shall not be liable for any malfunctioning and accident caused by said conversion.



WARNING

● Primary side and Secondary side

The monitor's circuit which is divided into the Primary side and Secondary side, is insulated. Do not touch the primary side, or do not touch both the primary side and the secondary side simultaneously. Not following the instruction can cause shock and this is very dangerous. When making monitor adjustments, use a non-conductive driver and make adjustment without touching any part other than the Adjustment V. R. and knob. Also, be sure not to cause a short-circuit to the Primary side and Secondary side. If short-circuited, it may cause shock or malfunctioning, which is very dangerous.

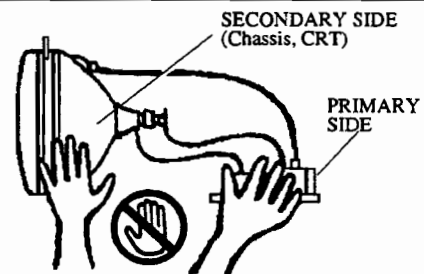

● High-tension Voltage

Some of the parts inside monitor are subject to high-tension voltage in excess of 20,000 volts and very dangerous. Therefore, be sure not to touch the monitor interior. Should soldering & paper wastes, etc. be mixed in the monitor interior, turn the power off so as not to cause malfunctioning or fire hazard.

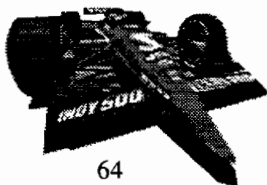
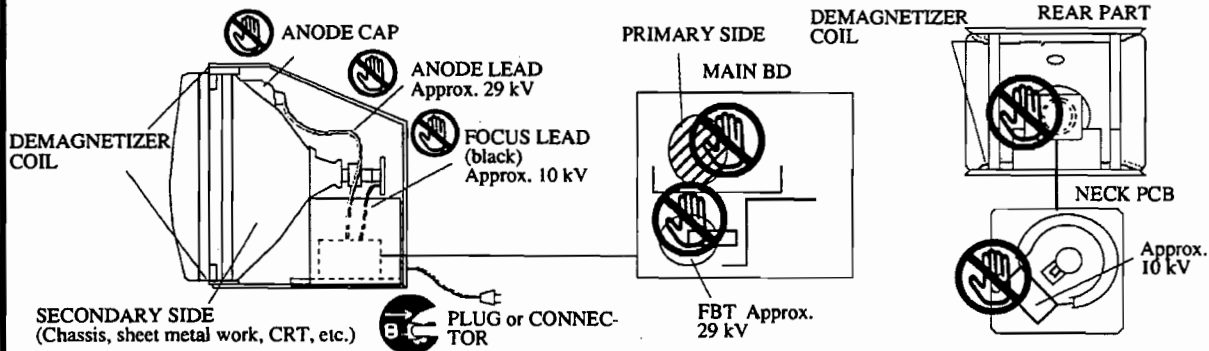



- **Connecting the CRT and PCB**

For combining the CRT and PCB, use the specified part No. to maintain the status of adjustments made at the factory. The anode of the CRT itself will be accumulatively charged as time elapses, generating high-tension voltage which is very dangerous. The monitor should be used with the Chassis, CRT and PCB assembled. When repair, etc. is required at the time of malfunctioning, be sure to send it in an "as is assembled" condition. If these are disassembled, what's charged to said high tension voltage can be discharged, causing a very hazardous situation. Therefore, under no circumstances should it be disassembled.

- **Static Electricity**

Touching the CRT surface sometimes causes you to slightly feel electricity. This is because the CRT surfaces are subject to static and will not adversely affect the human body.

- **Installation and removal**

Ensure that the Magnetizer Coil, FBT (Fly-Back Transformer), Anode Lead and Focus Lead are not positioned close to the sheet metal work's sharp edges, etc. and avoid damaging the insulated portions so as not to cause shock and malfunctioning. (For the name of parts, refer to the above Figures).

MONITOR ADJUSTMENT

The monitor adjustment knobs are located inside the upper rear access panel, as shown in Figure 50. Remove the upper rear service panel to make adjustments to the monitor in conjunction with the CRT Test Menu. The function of each control is shown in Figure 51.

CAUTION!

Do not operate adjustment knobs without a good reason.

Monitor operates on HIGH VOLTAGE - use caution when adjusting.

Use a plastic screwdriver when adjusting monitor.

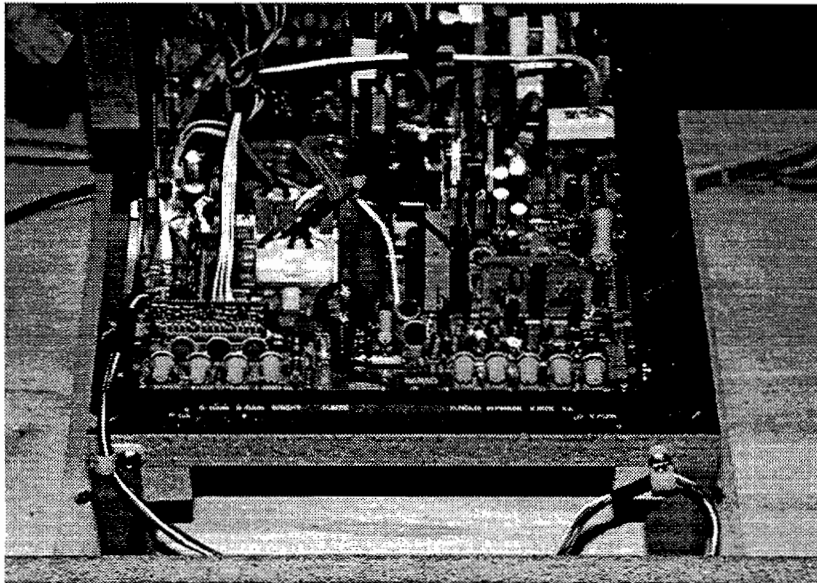
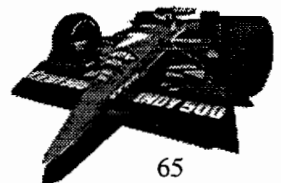
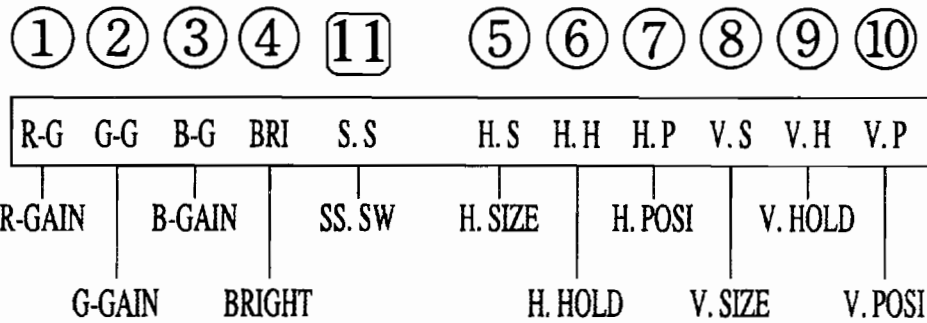

FIGURE 50: MONITOR CONTROLS LOCATION



NANAO monitor: 2 0 0 - 5 2 4 2 - 2 4 - 0 4 (24K mode)



- ① R-GAIN
- ② G-GAIN Controls colors.
- ③ B-GAIN
- ④ BRIGHT Controls screen brightness.
- ⑤ H. SIZE Controls horizontal screen size.
- ⑥ H. HOLD..... Provides horizontal synchronization, i.e., controls right/left blurring of image.
- ⑦ H. POSI Controls horizontal display position on screen.
- ⑧ V. SIZE Controls vertical screen size.
- ⑨ V. HOLD..... Provides vertical synchronization, i.e., controls up-down scrolling of image.
- ⑩ V. POSI Controls vertical display position on screen.
- ⑪ SS. SW Controls the visual quality. (Only applies to Nanao.)

A: Ordinary B: Super-sharpness

FIGURE 51: NANAO MONITOR CONTROL FUNCTIONS

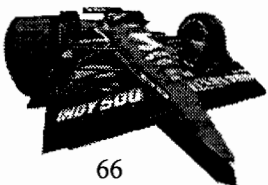

UNDERSEAT CABINET ACCESS

The Indy 500 Twin's Game Board Sets, DIP Switches, Power Supplies, Fuses, and Underseat Speakers are located in the left- and right-slide locked underseat cabinets.

OPENING THE UNDERSEAT CABINET

1. Turn off the game at the power switch and unplug the Indy 500 Twin game.
2. Place a sheet of cardboard or a cloth on the ground along the front edge of the game (behind the seat) to protect the seat from damage.
3. Remove the two #15 anti-tamper Torx screws (and washers) that secure the seat to the underseat cabinet. They are located just above the two locks on the opposing sides of the underseat cabinet (see Figure 52).
4. Unlock the two locks on opposing sides of the underseat cabinet (see Figure 52). The same key is used for both the locks on both the left- and right-side underseat cabinets.
5. Grasp the seat from the side, near the front of the base, not along the top of the seat area. Incline the seat (the hinge is at the back of the seat) away from the monitor.
6. Tip the seat slowly up and back until the seat's back edge is resting on the protected ground (see Figures 52 and 53). Be careful not to catch or pinch your fingers between the seat and the monitor cabinet.
7. Remove the four anti-tamper Torx screws that secure the front floorboard to the cabinet.
8. Perform any necessary servicing - see Design Related Parts section for component locations, and subsequent sections for servicing information on speakers, fuses, DIP switches, etc.

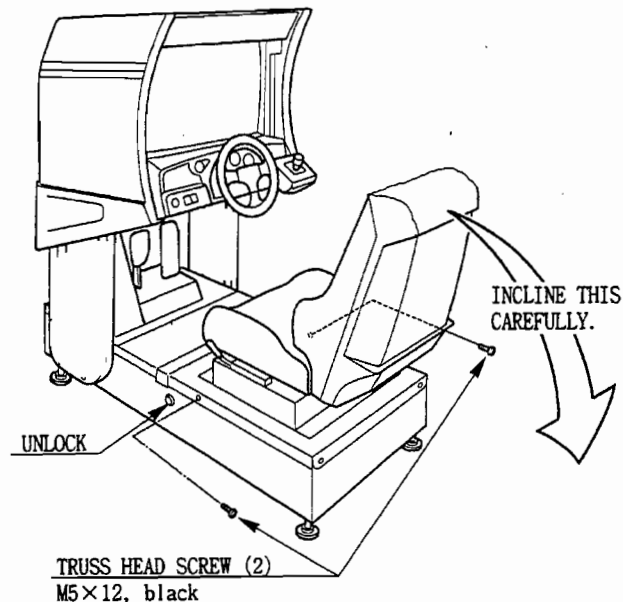
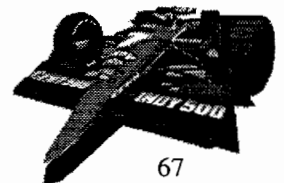

FIGURE 52: UNDERSEAT CABINET ACCESS



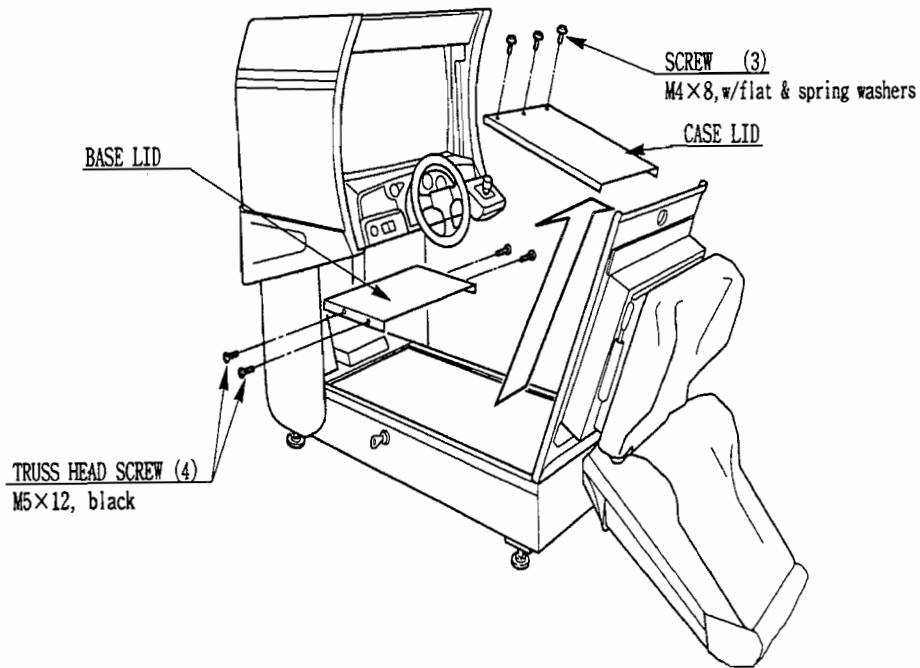
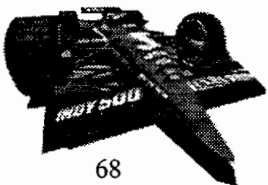

FIGURE 53: UNDERSEAT CABINET LID REMOVAL

CLOSING THE UNDERSEAT CABINET

1. Install the four anti-tamper Torx screws that secure the front floorboard over the game board and power supply.
2. Grasp the seat from the side, near the front of the base, not along the top of the seat area.
3. Tip the seat slowly up and forward until the bottom of the seat rests on the underseat cabinet top edge (see Figures 52 and 53). Be careful not to catch or pinch your fingers between the seat and the monitor cabinet.
4. Lock the two locks on opposing sides of the underseat cabinet (see Figure 53). The same key is used for both the locks on both the left- and right-side underseat cabinets.
5. Install the two #15 anti-tamper Torx screws (and washers) that secure the seat to the underseat cabinet. They are located just above the two locks on the opposing sides of the underseat cabinet (see Figure 53).
6. Plug the Indy 500 Twin game and turn on the power.



REPLACING FANS AND FUSES

The fans, and AC and steering wheel fuses are located in the left- and right-side underseat compartments.

1. Open the underseat compartment on the affected side. See Figure 54 for fuse and fan locations.
2. To replace the AC fuse, remove the floor board and the Throttle and Brake panel on the affected side. Replace with a 12A 250V Slo Blo fuse.
3. The steering wheel fuse is located on the Amp board. Replace with a 7A 250V Fast Blo fuse.
4. The fan is located at the rear of the game board case. Replace with a 4-inch, 12V DC fan.
5. Replace the Throttle and Brake assembly, the floor-board, and close and lock the underseat compartment.

LUBRICATING THE SEAT RAILS

The seat rails should be lubricated once every three months.

1. Move the seat to the rearmost position (away from the monitor).
2. Apply spray lubricant to the portion shown in Figure 55.
3. Move the seat back and forth a few times to distribute the lubricant evenly.
4. Clean up any overspray on the seat, floor, or other surfaces.

REPLACING THE UNDERSEAT SPEAKER

The underseat speaker is located in the underseat compartment lid.

1. Open the underseat compartment on the affected side.
2. Disconnect the underseat speaker cabling.
3. Close and lock the underseat compartment.
4. Remove the four bolts holding the seat to the underseat compartment lid.
5. Carefully lift the seat off the underseat compartment and set it on the floor.
6. Remove the six screws that hold the speaker case to the frame and replace the underseat speaker.
7. Replace the seat.
8. Open the underseat compartment and reconnect the speaker cabling.
9. Close and lock the underseat compartment.

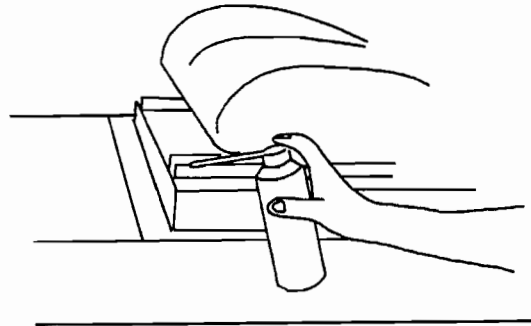

FIGURE 55: LUBRICATING THE SEAT RAILS

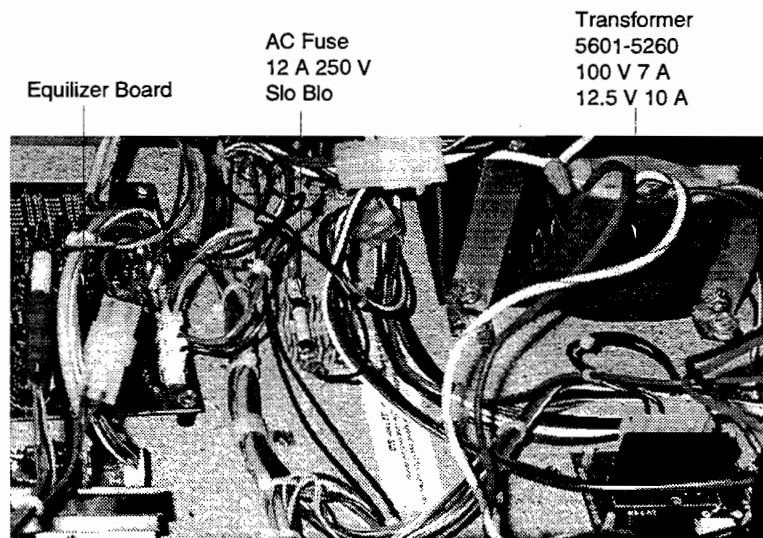
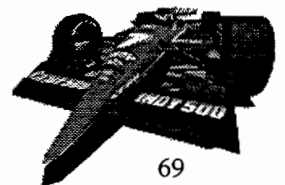

FIGURE 54: AC FUSE LOCATION



DRIVE BOARD DIP SWITCH SETTINGS

If the Steering Wheel Centering Level cannot be set satisfactorily using the Output Test menu, the Drive Board DIP switch settings may need to be changed.

1. Open the underseat cabinet on the same side as the effected steering wheel.
2. Remove the three slotted screws that secure the Shield Case lid and remove the lid (see Figure 56).
3. The Drive Board is located as shown in Figure 48, and the DIP switches are located as shown in Figure 57.
4. Change the settings on DIP switch 1, switches 1-3, per Table 22.
5. Leave the remainder of the DIP switches set as they were.
6. Replace the Shield Case lid and replace the three screws.
7. Close the underseat cabinet.
9. Set the variable values in the Control Range ("Volume") menu.
10. Close the rear access panel.

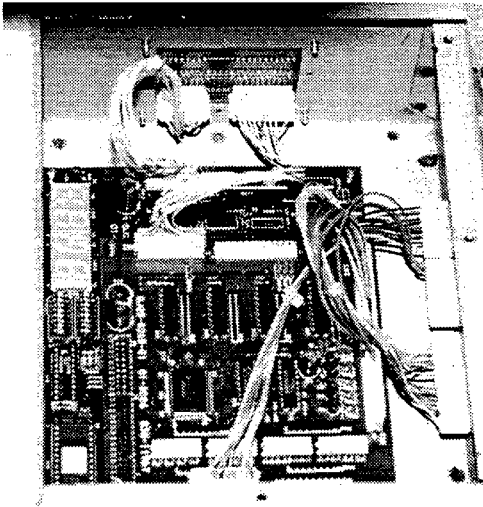
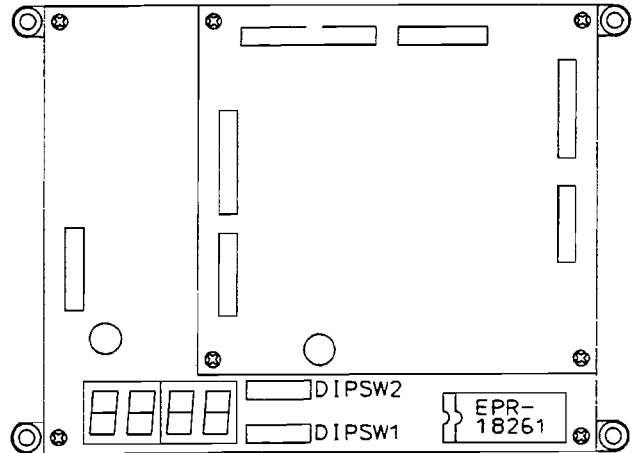

FIGURE 56: DRIVE BOARD LOCATION



DRIVE CONTROL BD (838-11967)

FIGURE 57: DRIVE BOARD DIP SWITCH LOCATIONS

Table 22: Drive Board DIP Switch 1 Settings

NOTE: The shaded portion refers to the setting at the time of shipment.

1	2	3	FUNCTION
OFF	OFF	OFF	Light
ON	OFF	OFF	↑
OFF	ON	OFF	
ON	ON	OFF	↓
OFF	OFF	ON	
ON	OFF	ON	↓
ON	ON	ON	

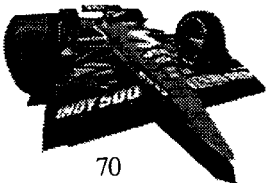

ACCELERATOR AND BRAKE GREASING, ADJUSTMENT, AND REPLACEMENT

If the Gas Pedal and Brake Pedal values cannot be set within the appropriate ranges in the Input Test menu, an adjustment of the accelerator or brake potentiometer is needed. If the accelerator or brake cannot be adjusted appropriately, the accelerator or brake potentiometers need to be replaced. The gears and shafts should be greased every three months.

ADJUSTING

1. The Indy 500 Twin game must be left plugged in and turned on. Exercise caution in using tools around the plugged-in game.
2. Open the lower rear service panel on the affected side. From the rear, the Brake is on the right, and the accelerator is on the left (see Figure 58).
3. Loosen the two screws that secure the potentiometer (V.R.) bracket, and move the bracket to disengage the gears.
4. With the Input Test menu on-screen, make adjustments by releasing the accelerator or brake pedal so that the variable value is below 30H.
5. Mesh the gears to secure the bracket. Be sure that the gear is fully engaged and tighten the bracket screws.
6. Loosen the two screws which secure the adjust gear.
7. With the Input Test menu on-screen, make adjustments by stepping on the accelerator or brake pedal so that the variable value is above C0H.
8. When the desired value has been obtained, retighten the two adjust screws.
9. Close the rear access panel.
10. Set the Gas and Brake Pedal variable values in the Control Range ("Volume") menu.

POTENTIOMETER REPLACEMENT

1. Turn off and unplug the Indy 500 Twin game.
2. Open the lower rear service panel on the affected side.
From the rear, the Brake is on the right, the Accelerator is on the left (see Figure 58).
3. Loosen the two screws which secure the potentiometer (V.R.) bracket (see Figure 59).
4. Remove and replace the potentiometer, bracket and gear.
5. Replace the bracket screws.
6. Close the rear access panel.
7. Turn on the Indy 500 Twin game.
8. In the Input Test menu verify the potentiometer values by stepping on the accelerator or brake pedal and verifying that the variable value is above C0H, and releasing the accelerator or brake pedal and verifying that the variable value is below 30H.
9. Set the Gas and Brake Pedal variable values in the Control Range ("Volume") menu.

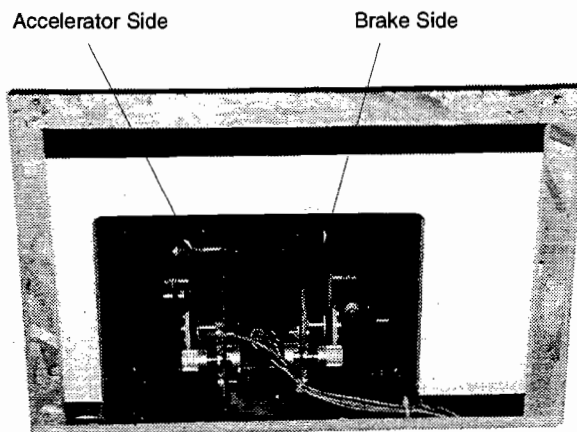
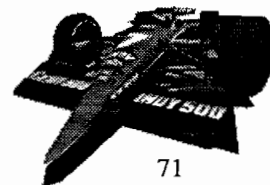

FIGURE 58: ACCELERATOR AND BRAKE ASSEMBLY ACCESS



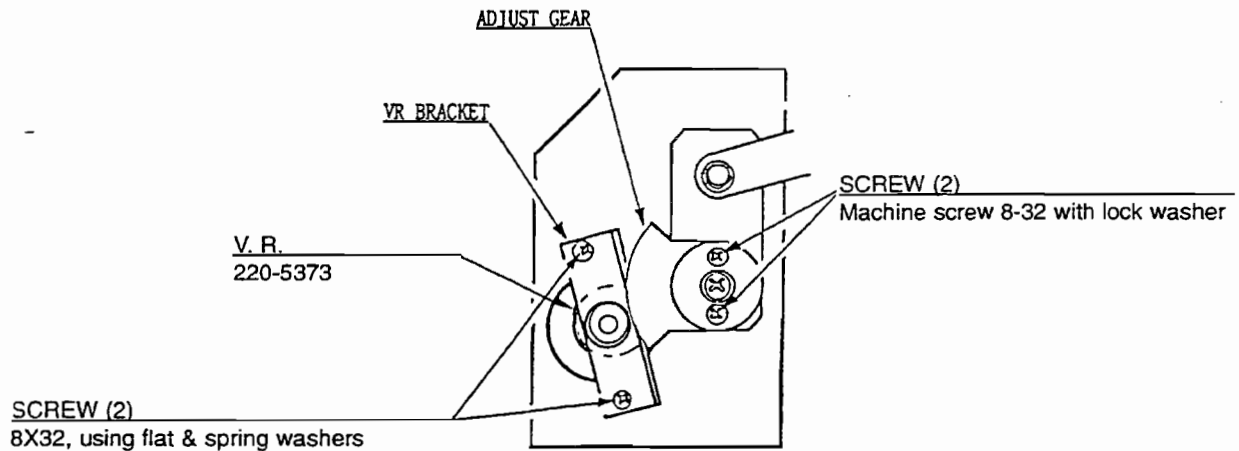

FIGURE 59: ACCELERATOR AND BRAKE ASSEMBLY

GREASING

1. Turn off and unplug the Indy 500 Twin game.
2. Remove the four hex bolts that secure the Accelerator and Brake assembly to the floorboards.
3. Remove the two phillips screws that secure the Accelerator and Brake assembly to the back panel.
4. Carefully slide the Accelerator and Brake assembly toward the seat, using caution to avoid damaging the cable harness.
5. Disconnect the Accelerator and Brake assembly harness.
6. Move the Accelerator and Brake assembly to a work location. The unit weighs approximately 5 lbs.
7. Remove the 4 tamperproof screws which secure the Pedal Cover and remove the Pedal Cover by sliding it forward.
8. Remove the Pedal Shaft from the lower portion of the accelerator and brake pedals. At this time, ensure that the accelerator and brake pedals are firmly secured as they are subjected to the torsion spring force.
9. Apply grease to the torsion spring, the pedal shaft, and the pedal bolt on both the accelerator and brake sides (see Figure 60).
10. Reassemble and install the Accelerator and Brake assembly.

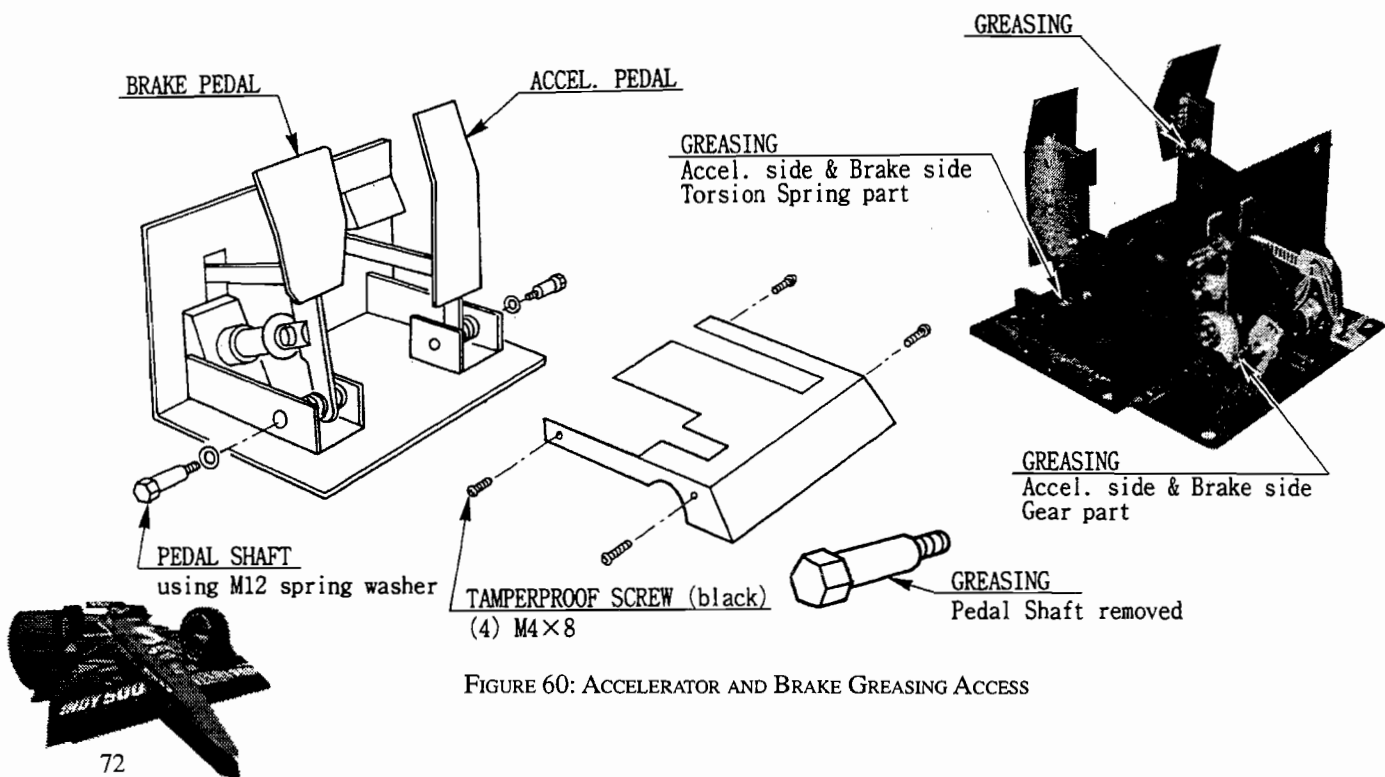

FIGURE 60: ACCELERATOR AND BRAKE GREASING ACCESS

STEERING WHEEL SERVICE

If the Steering Wheel values cannot be set within the appropriate ranges in the Input Test menu, an adjustment of the potentiometer is needed. If the potentiometer cannot be adjusted appropriately, it needs to be replaced. The gears should be greased every three months.

CAUTION!

The Control Panel weighs approximately 10 lbs. Use care in moving and handling.

The Steering Wheel motor may be hot after use. Wait until it cools to service.

ACCESS

1. Turn off the Indy 500 Twin game.
2. Remove the six tamperproof screws that secure the Control Panel to the cabinet on the affected side (see Figure 61).
3. Carefully pull the Control Panel away from the cabinet, using caution to avoid damaging the wiring.
4. To replace, connect the wiring harness, lift into place, and secure the six screws.

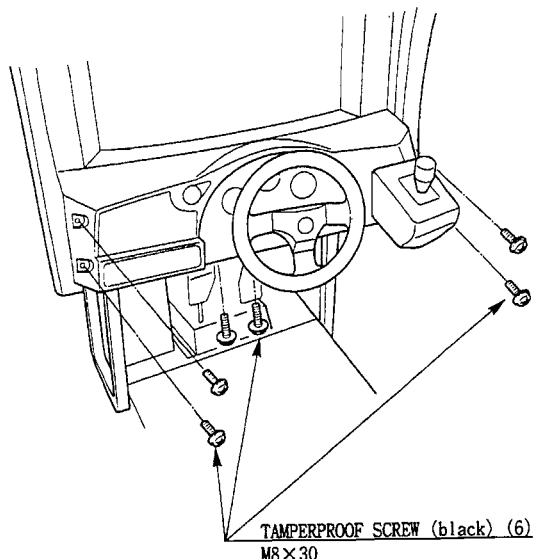
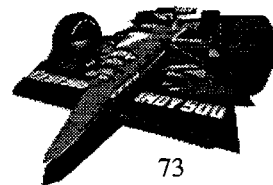

FIGURE 61: CONTROL PANEL ACCESS

ADJUSTING

The gear near the RED cable is connected to the Motor Drive Board. The gear near the YELLOW cable is connected to the Game and Drive Control Boards. Refer to Figure 62 for parts locations.

1. The Indy 500 Twin game must be left plugged in and turned on. Exercise caution in using tools around the plugged-in game.
2. Remove the Control Panel, but do not disconnect the wire harnesses.
3. Loosen the two hex bolts under the appropriate outer gear, move the bracket, and disengage the gear.
4. With the Input Test menu on-screen, make adjustments by turning the Steering Wheel.
5. Mesh the gears to secure the bracket. Be sure that the gear is fully engaged and tighten the bracket screws.
6. While the Steering Wheel is in the centered position, make fine adjustments by loosening the two screws on the top of the gear and turning the gear holder.
7. When the desired value has been obtained, retighten the two upper screws.
8. Reinstall the Control Panel.
9. Set the Steering Wheel variable values in the Control Range ("Volume") menu.



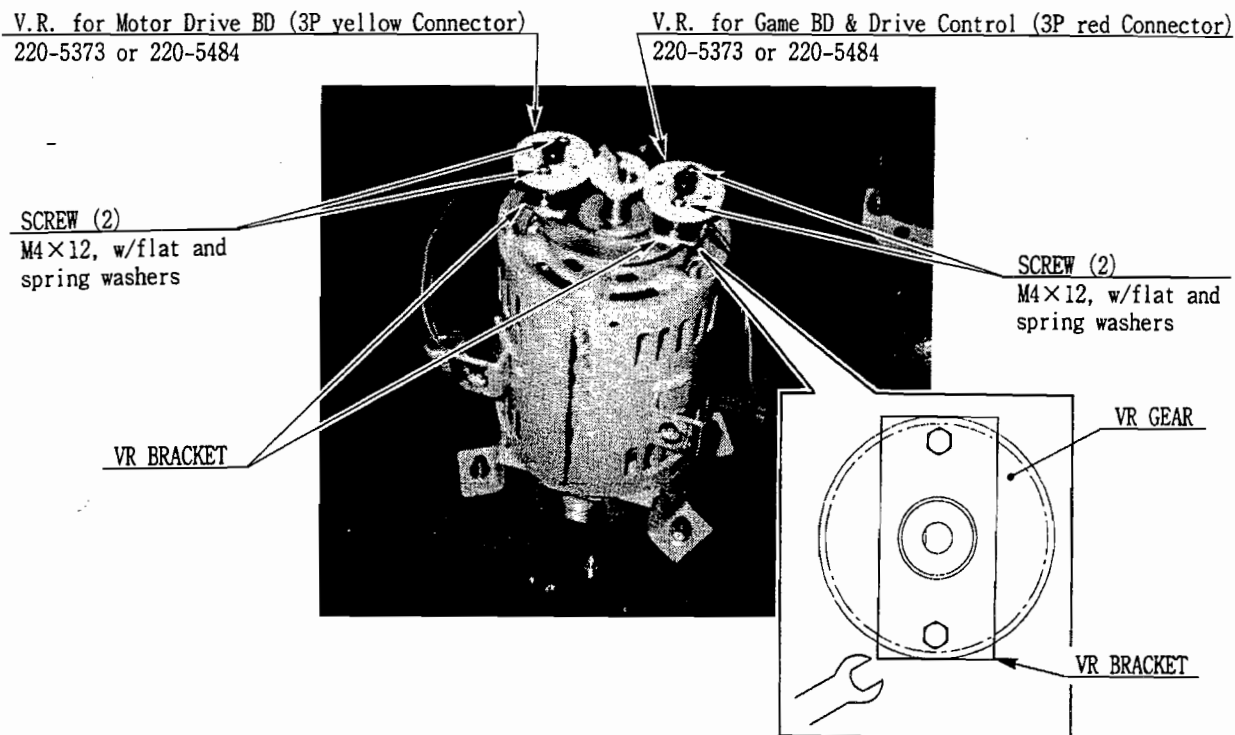
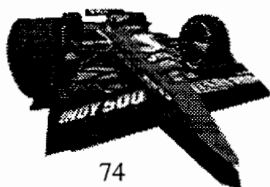

FIGURE 62: STEERING WHEEL ADJUSTMENT

POTENTIOMETER REPLACEMENT

The gear near the RED cable is connected to the Motor Drive Board. The gear near the YELLOW cable is connected to the Game and Drive Control Boards. Refer to Figure 62 for parts locations.

1. Turn off and unplug the Indy 500 Twin game.
2. Remove the Control Panel.
3. Disconnect the three 3-pin wiring harnesses (WHITE: Power, RED: Game Board and Drive Control Board, YELLOW: Motor Drive Board).
4. Loosen the two hex bolts under the appropriate outer gear, and remove the bracket and gear.
5. Replace the gear and bracket.
6. Mesh the gears to secure the bracket. Be sure that the gear is fully engaged and tighten the bracket screws.
7. Connect the three 3-pin wiring harnesses (WHITE: Power, RED: Game Board and Drive Control Board, YELLOW: Motor Drive Board).
8. Reinstall the Control Panel.
9. Set the Steering Wheel variable values in the Control Range ("Volume") menu.



GREASING

1. Turn off and unplug the Indy 500 Twin game.
2. Remove the Control Panel.
3. Apply lubricant to the area shown in Figure 63 once every three months. Use Shell Auto Grease (090-044 Net 300g).
4. Reassemble and install the Steering Wheel assembly.
5. Reinstall the Control Panel.

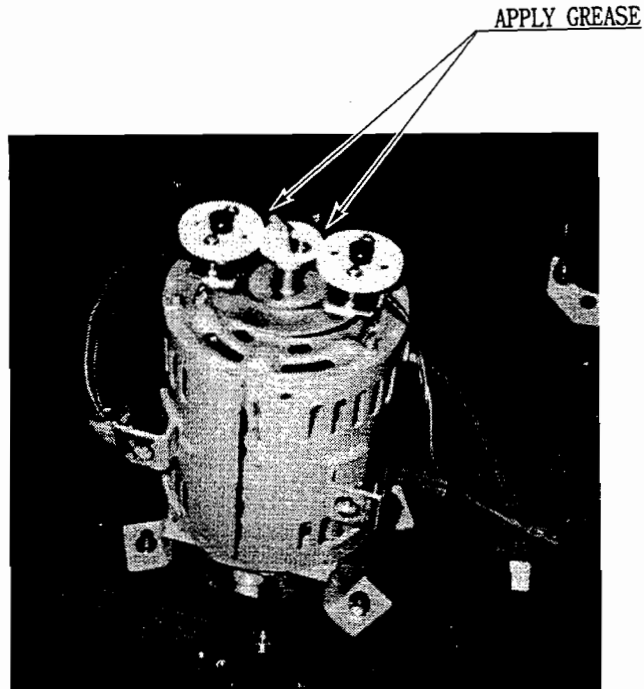
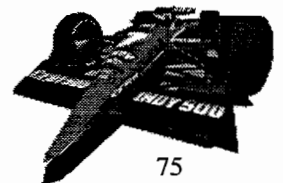

FIGURE 63: STEERING WHEEL GREASING



SHIFT LEVER GREASING AND SWITCH REPLACEMENT

Grease the shift lever every three months. If the shift lever values cannot be set appropriately in Test Menu, replace the shift lever's switch.

REMOVAL

1. Remove the four tamperproof screws that secure the shift lever to the control panel (see Figure 64).
2. Disconnect the connector that connects the shift lever cable to the cabinet wiring harness.

GREASING

1. Apply lubricant to the area shown in Figure 65 once every three months.
2. Use NOK KLUBER L 60 or Grease Mate (Part No. 090-00609).

SWITCH REPLACEMENT

1. Disconnect the wiring connector of the shift lever cable to the affected switch (see Figure 66).
2. Remove the two tapping screws that secure the switch to the shift lever.
3. Replace the malfunctioning switch with a similar switch (Part Number 95-4276-00).
4. Replace the tapping screws.
5. Replace the shift lever cable.

SHIFTER REPLACEMENT

1. Connect the shift lever cable to the cabinet wiring harness.
2. Set the shift lever assembly into position, ensuring that the "DOWN" label is on the upper section of the shift lever.
3. Replace the four tamperproof screws.

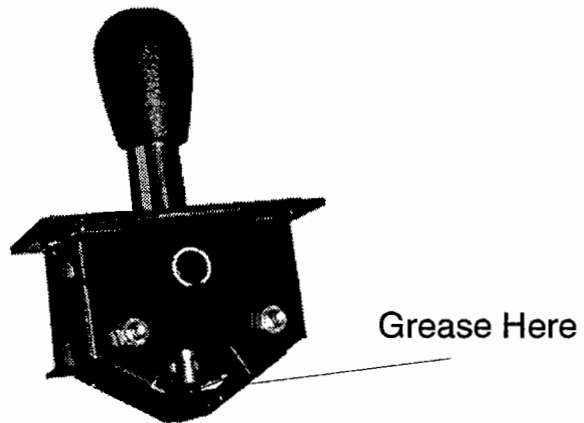

FIGURE 65: SHIFT LEVER GREASING

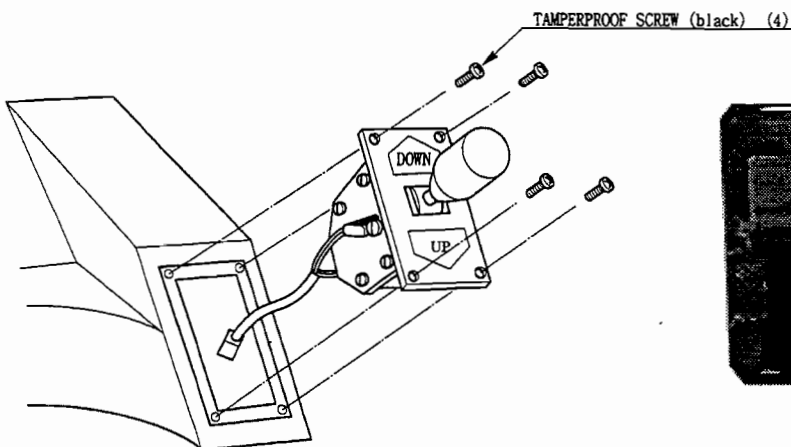

FIGURE 64: SHIFT LEVER ACCESS

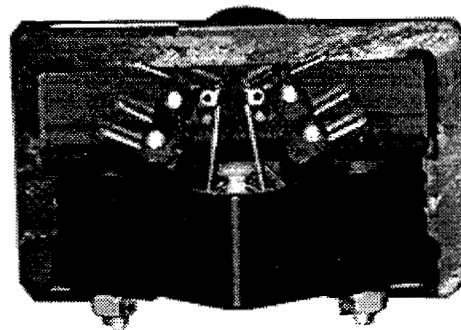
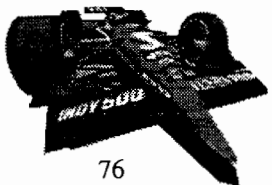

FIGURE 66: SHIFT LEVER SWITCH LOCATION



BUTTON LAMP REPLACEMENT

1. Turn off the game at the power switch and unplug the Indy 500 Twin game.
2. Remove the four tamperproof screws that secure the button cover plate to the Control Panel (see Figure 67).
3. The button cover plate is removed by rotating the three metal tabs that project out of each button at approximately 2 o'clock counterclockwise to 1 o'clock and lifting the cover plate off.
4. Replace the lamp with a 6.3V, 1W lamp.
5. Reinstall the button cover plate to the control panel.

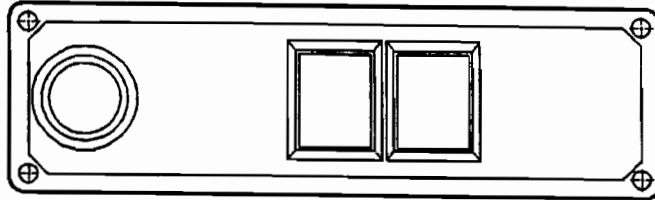
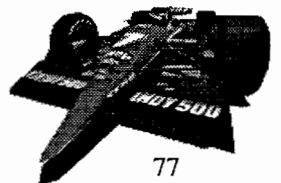
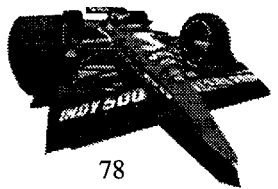
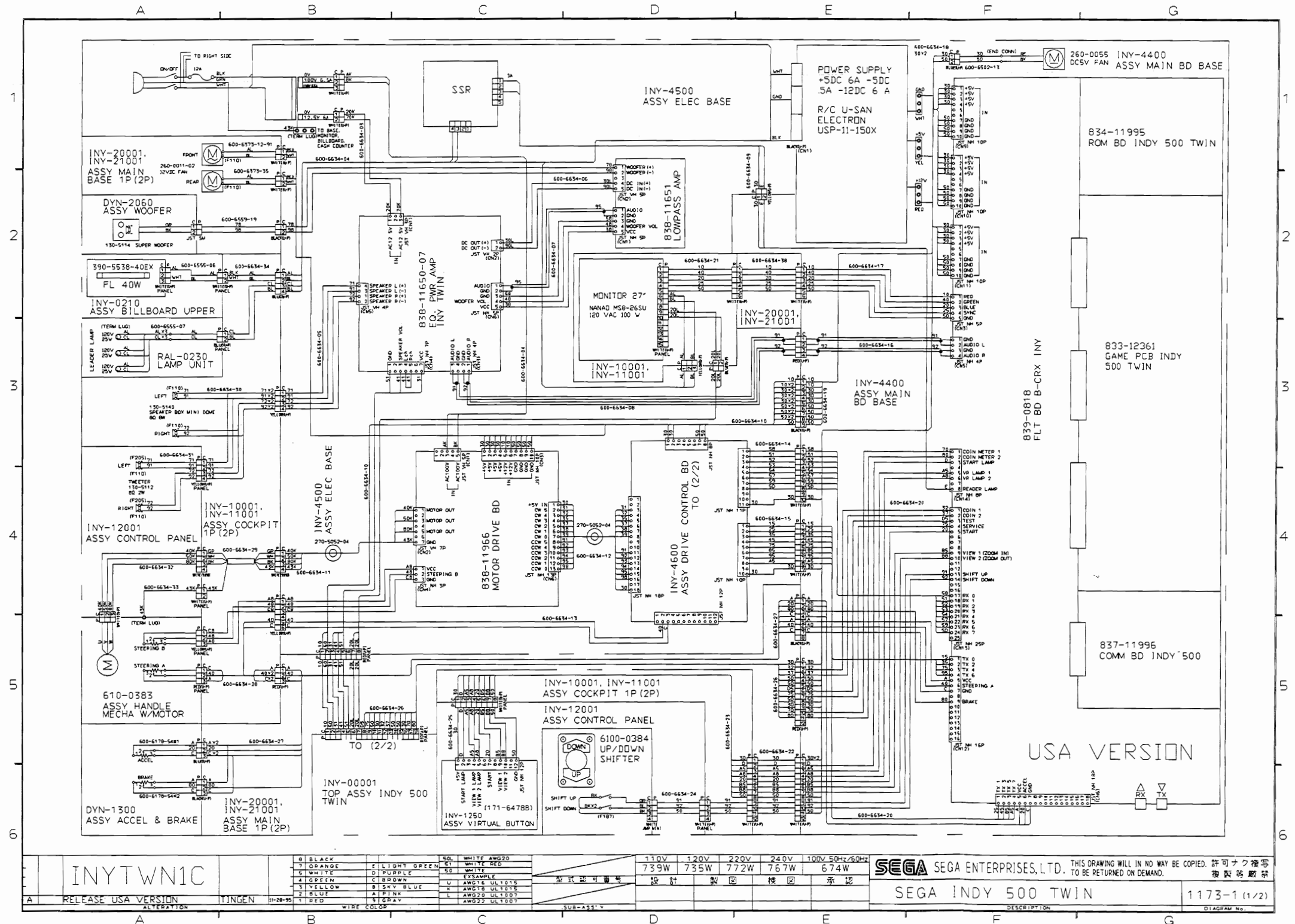

FIGURE 67: BUTTON ACCESS





WIRING DIAGRAM



INYTWN1C		0 BLACK	1 LIGHT GREEN	2 PURPLE	3 BROWN	4 YELLOW	5 BLUE	6 RED	7 WHITE	8 WHITE	9 WHITE	10 WHITE	11 WHITE	12 WHITE	13 WHITE	14 WHITE	15 WHITE	16 WHITE	17 WHITE	18 WHITE	19 WHITE	20 WHITE	21 WHITE	22 WHITE	23 WHITE	24 WHITE	25 WHITE	26 WHITE	27 WHITE	28 WHITE	29 WHITE	30 WHITE	31 WHITE	32 WHITE	33 WHITE	34 WHITE	35 WHITE	36 WHITE	37 WHITE	38 WHITE	39 WHITE	40 WHITE	41 WHITE	42 WHITE	43 WHITE	44 WHITE	45 WHITE	46 WHITE	47 WHITE	48 WHITE	49 WHITE	50 WHITE	51 WHITE	52 WHITE	53 WHITE	54 WHITE	55 WHITE	56 WHITE	57 WHITE	58 WHITE	59 WHITE	60 WHITE	61 WHITE	62 WHITE	63 WHITE	64 WHITE	65 WHITE	66 WHITE	67 WHITE	68 WHITE	69 WHITE	70 WHITE	71 WHITE	72 WHITE	73 WHITE	74 WHITE	75 WHITE	76 WHITE	77 WHITE	78 WHITE	79 WHITE	80 WHITE	81 WHITE	82 WHITE	83 WHITE	84 WHITE	85 WHITE	86 WHITE	87 WHITE	88 WHITE	89 WHITE	90 WHITE	91 WHITE	92 WHITE	93 WHITE	94 WHITE	95 WHITE	96 WHITE	97 WHITE	98 WHITE	99 WHITE	100 WHITE
RELEASE USA VERSION		TJNGEN		01-28-95		WIRE COLOR		SUB-ASSY		110V		120V		220V		240V		100V 50Hz/60Hz		739W		735W		772W		767W		674W		SEGA		SEGA ENTERPRISES, LTD.		THIS DRAWING WILL IN NO WAY BE COPIED. 許可なく複写 複製等厳禁		TO BE RETURNED ON DEMAND.		SEGA INDY 500 TWIN		1173-1 (1/2)		DIAGRAM No.																																																												

FIGURE 68: INDY 500 TWIN WIRING DIAGRAM - PAGE 1 OF 2

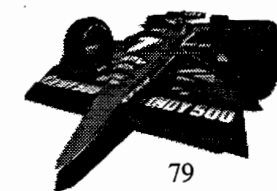

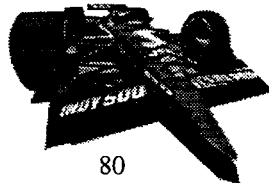

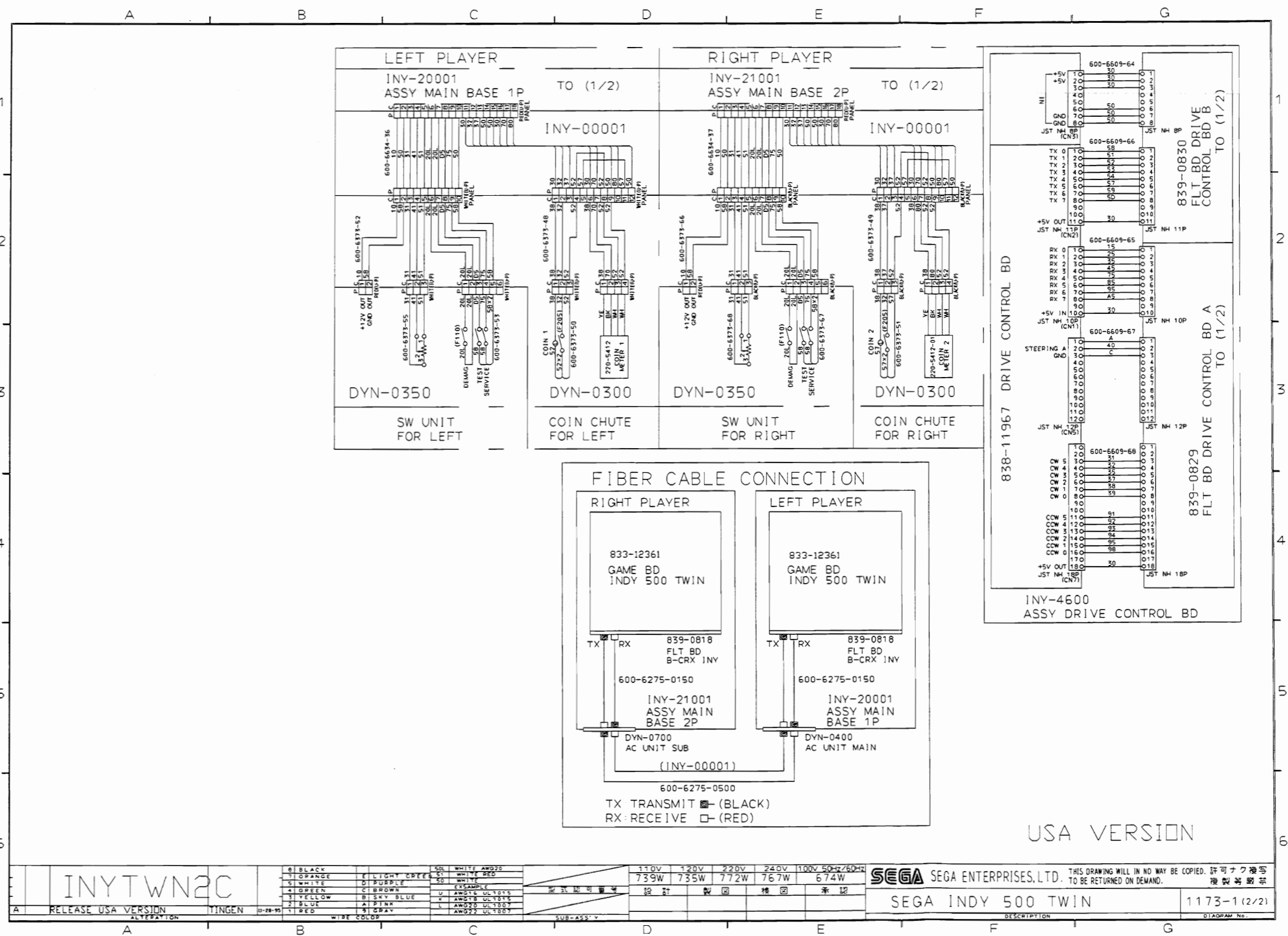
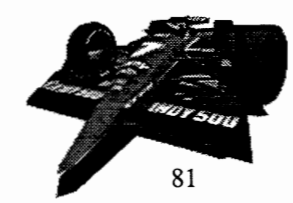
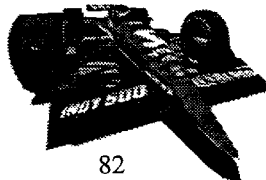

FIGURE 68 (CONT.) : INDY 500 TWIN WIRING DIAGRAM - PAGE 2 OF 2





COPYRIGHT NOTICE

This SEGA product has a copyright notice as follows:

© 1995 Sega Enterprises, Inc. (USA) All rights reserved.

This signifies that this work was disclosed in 1995 and is the property of SEGA ENTERPRISES, INC. (USA)

Every effort has been made to ensure that this manual is accurate. Sega Enterprises, Inc. (USA) is not liable for any printing or clerical errors.

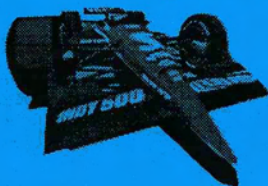

Specifications noted herein are subject to change without notice.