



STREET FIGHTER™

THE MOVIE



OPERATOR'S MANUAL
PM00120-KIT 5/95

CAPCOM®

COIN-OP, INC.

THANK YOU FOR PURCHASING *STREET FIGHTER : THE MOVIE™*.
CAPCOM® INVITES YOU TO USE THE FOLLOWING MAILING ADDRESS,
TELEPHONE OR FAX NUMBER FOR PARTS OR SERVICE INFORMATION
CONCERNING THIS GAME:

CAPCOM® COIN-OP, INC.
ATTN: FIELD SERVICE - VIDEO PRODUCTS
3311 N. KENNICOTT ROAD
ARLINGTON HEIGHTS, ILLINOIS 60004
PHONE: (708) 797-6100
FAX: (708) 797-6306

THE SERIAL NUMBER OF YOUR GAME IS LOCATED ON THE PRINTED
CIRCUIT BOARD SET AND STARTS WITH THE PREFIX *SFM* (Ex. SFM10001).

PLEASE HAVE THIS SERIAL NUMBER AVAILABLE WHEN CONTACTING US
FOR SERVICE INFORMATION.



WARNING

Federal law provides severe civil and criminal penalties for the unauthorized reproduction, distribution, or exhibition of copyrighted audiovisual works and video games.

The Federal Bureau of Investigation investigates allegations of criminal copyright infringement.

TABLE OF CONTENTS

<i>Warranty Information</i>	i
<i>Kit Inspection and Installation</i>	1
<i>Test Mode</i>		
Operator Adjustables Menu	5
Game Mode Selection	6
Game Resets	6
Attract Mode Sounds	6
Credit Settings	7
Violence Settings	7
Skill Level Adjustment	7
Horizontal Screen Adjustment	8
Game Audits Menu	8
Review Audits	8
Reset Audits	10
System Tests Menu	11
Video Screen Test	11
Sound Test	11
GROM Checksum Test	12
Video RAM Test	12
Player Control Test	13
Volume Settings	13
Palette RAM Test	13
Notes	14
<i>General Troubleshooting</i>		
Power-up Problems	15
Control Problems	15
Video Problems	16
Sound Problems	17
<i>Auxiliary JAMMA Cable Connections</i>	18
<i>Main JAMMA Harness Connections</i>	19
<i>Dip Switch Settings</i>	20
<i>Diagnostic Switch Settings</i>	20
<i>Fuse Information</i>	20

LIMITED PRODUCT WARRANTY (APPLIES TO DOMESTIC SALES ONLY)

CAPCOM® (Seller), warrants only to the initial purchaser of its products, that the items listed below are free from material and workmanship under normal use and service for the warranty periods specified:

- A. Printed Circuit Boards: (90) days
- B. Electronic and Mechanical Components: (90) days

No other part of Seller's products are warranted.

Warranty periods are effective from the initial date of shipment from seller to its authorized distributors.

Seller's sole liability shall be, at its option, to repair or replace products which are returned to Seller during the warranty periods specified, provided:

- A. Seller is notified promptly upon discovery by buyer that stated products are defective.
- B. Such products are properly packaged and then returned, prepaid to Seller's designated plant.

This warranty does not apply to any parts damaged during shipment or handling, or due to improper installation or alteration. In no event shall Seller be liable for any anticipated profits, loss of profits, loss of use, incidental or consequential damages or any other losses incurred by the customer in connection with the purchase of a CAPCOM® product.

WARRANTY DISCLAIMER

EXCEPT AS SPECIFICALLY PROVIDED IN A WRITTEN CONTRACT BETWEEN SELLER AND PURCHASER, THERE ARE NO OTHER WARRANTIES, EXPRESSED OR IMPLIED, INCLUDING ANY IMPLIED WARRANTIES OF MERCHANTABILITY OR FITNESS FOR A PARTICULAR PURPOSE.

IMPORTANT NOTICE

THIS SHIPMENT HAS BEEN CAREFULLY INSPECTED AND PROPERLY PACKAGED BEFORE LEAVING THE FACTORY. WE CANNOT ASSUME RESPONSIBILITY FOR BREAKAGE THAT MAY OCCUR DURING TRANSPORTATION OF THE GAME. IF THIS GAME IS DAMAGED UPON RECEIPT FROM THE CARRIER, IMMEDIATELY NOTIFY THE CARRIER AND FILE A DAMAGE REPORT.

KIT INSPECTION

The *STREET FIGHTER: THE MOVIE™* Kit is used to convert or update older video games to the newest version of this popular game. Open the packing carton and remove the parts. Check that all parts are in the kit. If any parts are missing or damaged, contact your distributor.

Kit Parts List

Part No.	Description	Qty.
GE2030	Joystick (4/8 way)	2
A-0016500	Complete Game PCB Set	1
LBO0128	Label, Notice, FCC Compliant	1
LBO0131	Label, Game Features	1
PM00120-Kit	Manual, Operator	1
SC00119-04	Screw #8 x 1/2 SLHWH "AB" ZC	6
16-0130	Switch, Push-button Micro, 1-Player, White	1
16-0131	Switch, Push-button Micro, 2-Player, White	1
16-0133	Switch, Push-button Micro, Red	4
16-0134	Switch, Push-button Micro, Blue	4
16-0136	Switch, Push-button Micro, Green	4
AW00144	Marquee	1
AW00145-1	Overlay, Control Panel	1
AW00146	Decal, 6-Button and Joystick	1
C-00144-7	Cable Assy, JAMMA Auxiliary	1
PM00121	Template, control panel Drill Hole	1

KIT INSTALLATION



WARNING:

MAKE SURE THAT ELECTRICAL POWER TO THE GAME IS OFF PRIOR TO STARTING THE KIT INSTALLATION.

Old Component Removal

- 1) Disconnect and remove the old printed circuit board(s) from the cabinet.
- 2) Remove or open the control panel, and disconnect and remove the buttons and joystick(s) from the control panel.
- 3) Remove any covering from the control panel overlay, and then remove the control panel overlay.

Preparation:

1. Place the PM00121 joystick and button template supplied in your kit over the control panel to determine where any new holes should go. Center punch any needed new holes on the control panel.
2. Cut out the new holes.
3. If there is an additional control panel cover (such as plastic or lexan) that will be utilized, cut any additional holes using the same template.
4. Plug up unused holes with a wood dowel (1-1/8" diameter) and sand any rough edges.

Control Panel Overlay Installation:

1. The control panel overlay in the kit is oversized to accommodate most control panel sizes. Center the overlay on the control panel, leaving some excess material at the edges.
2. Remove the protective backing from the overlay and press it down on the control panel, keeping it properly aligned. Press it down firmly, smooth out any bubbles, and press it over the edges.
3. Trim any excess from the overlay. Place the drill hole template on top of the overlay, aligning it with the joystick holes. Pierce through the overlay at each control panel hole. Then, cut away overlay material covering the joystick and button holes. Cut out holes for the Player 1 and Player 2 Start buttons. Remove the template and clean off the overlay.
4. Peel off the backings of the 6-button and joystick decals AW00146, align over the control panel holes, and press in place on the overlay.

Replace the control panel plastic. See Figure 1.

FIGURE 1
Overlay Installation

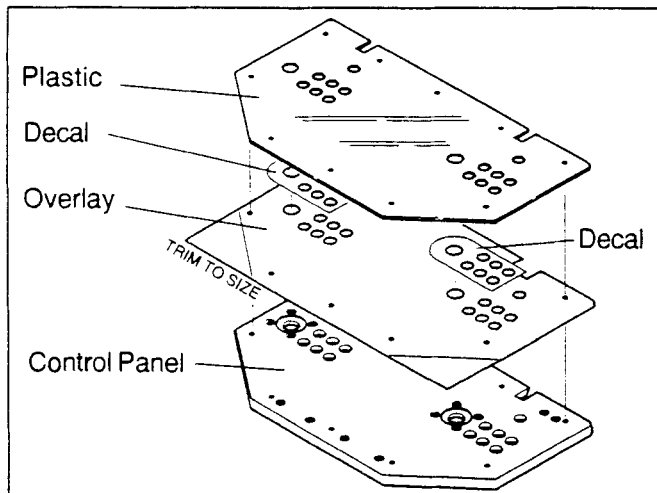

Marquee Installation

1. Remove the marquee glass, old marquee overlay, and the old cabinet graphics.
2. Install the new marquee graphics and replace the glass.

Wiring and Harness Assembly

NOTE:

All switch wires used in this game must be wired to the normally-open connection on the switches. Each switch requires a ground wire on the common connector and the appropriate control or switch wire on the normally-open connector of the switch.

Buttons and Joysticks

1. Install all buttons and retaining rings on the control panel as shown in Figure 2. Install two RED buttons to the immediate right of each joystick, install two BLUE buttons to the right of the red ones, and install two GREEN buttons to the right of the blue ones.

FIGURE 2
Control Panel Buttons and Switches

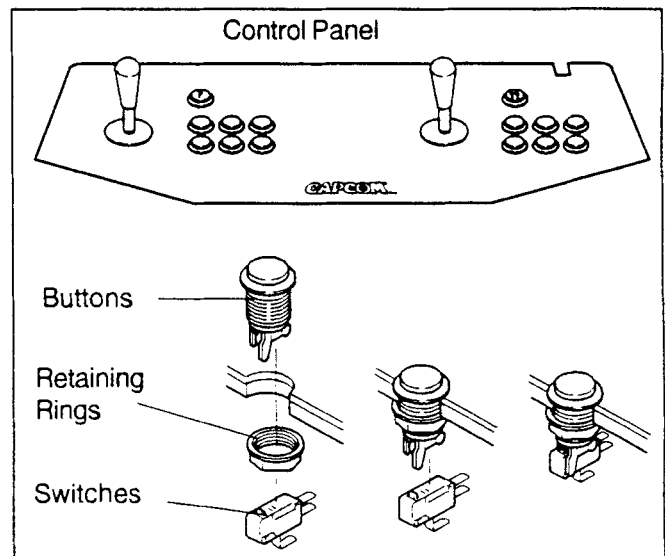

2. Notice that there are two white buttons. (See Figure 3.) Install the PLAYER ONE button on the top left-hand side of the control panel, and the PLAYER TWO button on the top right-hand side of the control panel. The WHITE buttons are START buttons.

FIGURE 3
Function and Start Buttons

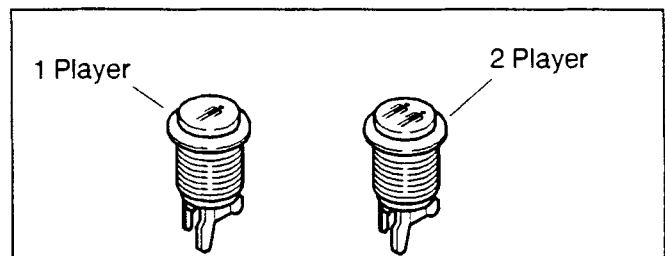

3. Install the switches on the buttons as shown in Figure 2. Orient the switches so that when a button is pressed, the red contact on the switch is depressed.

4. Install the joysticks on the control panel as shown in Figure 4.

FIGURE 4
Joystick Installation

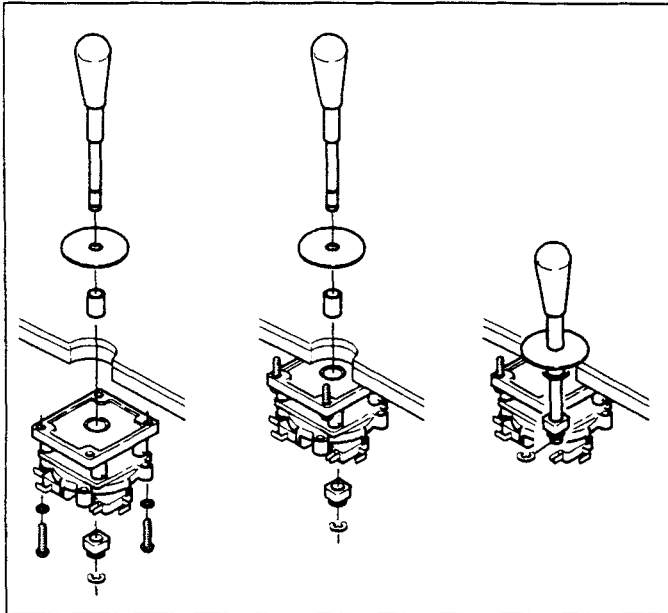

5. Connect the FIERCE, SHORT, and FORWARD button switches to the JAMMA auxiliary cable shown in Figure 5. Connect the JAMMA auxiliary cable leads (female spade) to the FIERCE, SHORT, and FORWARD control panel button switches as shown in the following chart.

FIGURE 5
JAMMA Auxiliary cable

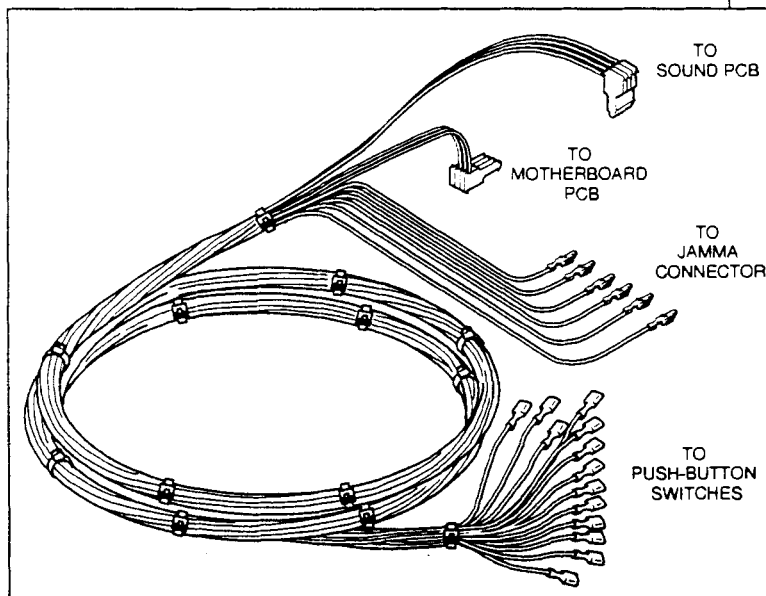

PLAYER No. 1		PLAYER No. 2	
Button	wire color	Button	wire color
FIERCE	White-Violet	FIERCE	Violet-Black
SHORT	White-Gray	SHORT	Violet-Gray
FORWARD	White-Black	FORWARD	Violet-White

The Black lead goes to the switches' ground connection, and the red and green leads are for speaker connections.

6. Install the other ends of these wires into the game's original JAMMA wiring harness connector as shown in Figure 6.

FIGURE 6
JAMMA Connector

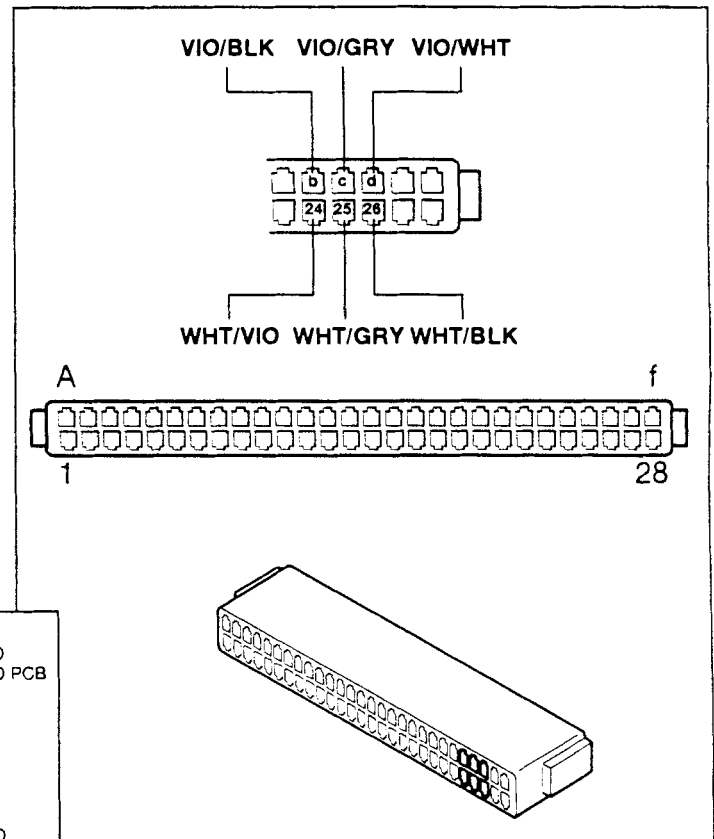

Press the pins into pin locations b, c, and d, and 24, 25, and 26, from the backs of the connector's pin openings. Follow the wire colors shown in Figure 6.

7. Connect the remaining buttons and the joysticks to the original JAMMA harness according to the wiring chart shown in this manual.

Printed Circuit Board

1. Mount the PCB to the cabinet in the space where the old PCB was mounted. Mark and drill pilot holes. Attach the PCB standoffs to the cabinet using wood screws and spacers. Do not overtighten the screws or the board may warp or crack.

Wire Harness

1. Attach the kit wire harness connectors to the new PCB as shown in Figure 6. Notice that the 3-pin connector goes to JP12.

FIGURE 6
Kit Wire Harness PCB Connections

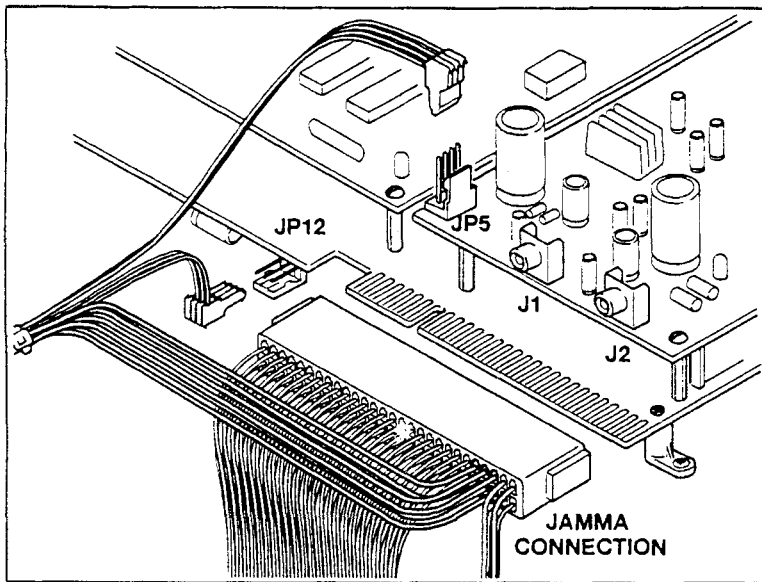

These outputs connect directly to the left and right speakers.

The connectors are keyed. Be sure they are mounted correctly.

WARNING:

Plugging the JAMMA connector in backwards will cause damage to the PCB.

NOTE:

This game requires a JAMMA standard wiring harness. If your original game does not use a JAMMA harness, you should change to one.

Audio Level

Audio output level is changed by going to Test Mode and adjusting Volume Level setting.

Label Instructions

There are two stick-on labels that come with the kit. LB00128 is an FCC Compliance Notice Label. Peel off the backing from the sticker and apply it to the back of the game, as shown in Figure 7. LB00131 is a Game Features Label that goes on the monitor bezel or on the control panel. Peel off the backing and apply the sticker to either of the locations shown in Figure 7.

FIGURE 7
Sticker Locations

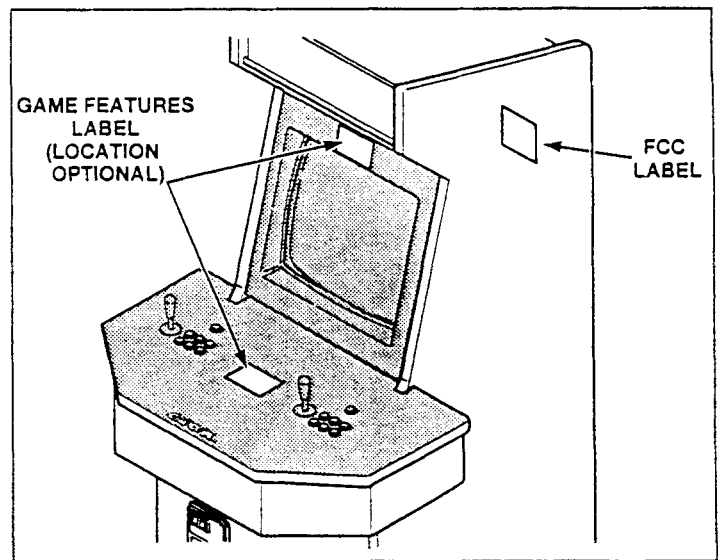

JP 12 Connections

wire color

- Pin 1 - Player 1 RoundHouse
- Pin 2 - Ground
- Pin 3 - Player 2 RoundHouse

- Wht
- Blk
- Vo

(See Pinout Table)

JP 5 Speaker connections

wire color

- Pin 1 - L (+)
- Pin 2 - L (-)
- Pin 3 - R (+)
- Pin 4 - R (-)

- Red/Gry
- Red/Blk
- Gm/Gry
- Gm/Blk

(See Pinout Table)

J1 and J2 are low-level stereo audio outputs. If used, they require amplification or an amplifier board.

TEST MODE

To enter the Test Mode, press the Test Button, located just inside the coin door. When the Test Button is pressed or DIP Switch 1 is flipped to the OFF position, the screen displays the Main Service Menu.

NOTE

If you used the DIP switch to enter the TEST MODE, you will need to flip the DIP switch back to the ON position in order to return to the game.

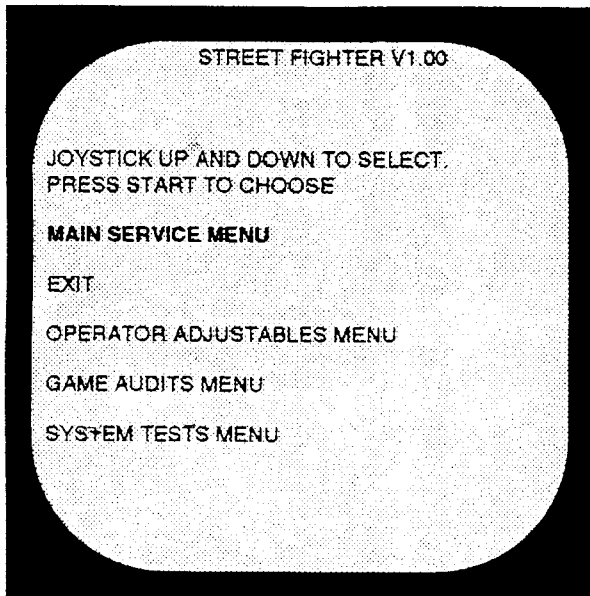

MAIN SERVICE MENU

The Main Service Menu allows you to enter into three different areas.

OPERATOR ADJUSTABLES is used for customizing your game for your location. Some of the features in Operator Adjustables are number of coins per game, sounds on or off when no one is playing, difficulty settings, etc.

GAME AUDITS allow you to check your games' overall earnings, game times, game scores, etc. The Audits can be reset through this menu as well.

SYSTEM TESTS verifies the operation of the hardware, controls, and monitor through easy and automatic procedures accessed through these menus.

To exit any of these tests and return the game to its normal state, use any player joystick to highlight the line that says EXIT and press any player start button.

COLOR KEY NOTE

For easy identification, all test screens have been color-coded. Items displayed in GREEN are the MENU titles. This is the name of the menu that is currently displayed. Items appearing in YELLOW are the menu's instructions. The BLUE items are choices available in this menu. The WHITE item is the selection that is currently highlighted. If RED is ever displayed, there is a problem with that item and it should be corrected.

OPERATOR ADJUSTABLES

The Operator Adjustables section is accessed through the main service menu. From the Main Service Menu, move any player joystick down until the word **OPERATOR ADJUSTABLES MENU** appears in white letters. Now press any player start button, and the Operator Adjustables Menu will appear on the screen.

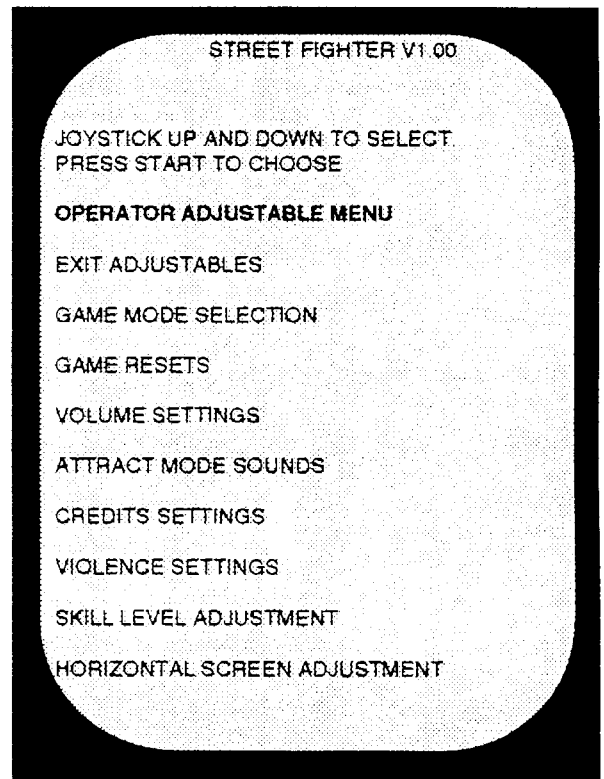

OPERATOR ADJUSTABLES MENU

There are many possible customizing procedures available with the game. Below is a brief description of each adjustable function and what the screen looks like when displayed. Remember, to select an item from any menu, use any player joystick to highlight the item in white, and then press any player start button.

Game Mode Selection

This menu allows you to place the game in standard Coin Mode, or choose free play.

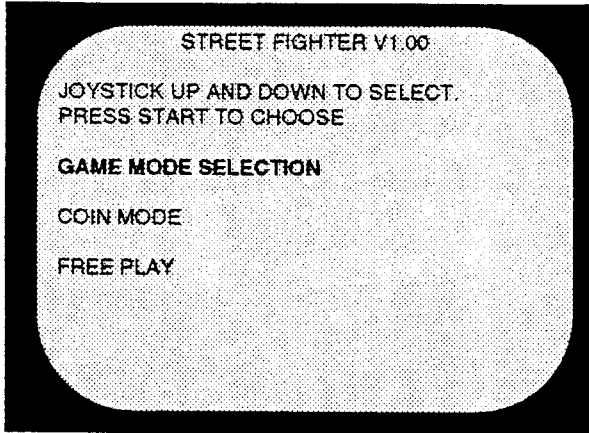

GAME MODE SELECTION SCREEN

In **COIN MODE**, the game will only work if coins are deposited into the game.

In **FREE PLAY**, coins are not needed for play and the Start buttons are always active.

GAME RESETS

The Game Resets Menu will cancel or zero-out any custom features or bookkeeping figures that are no longer wanted.

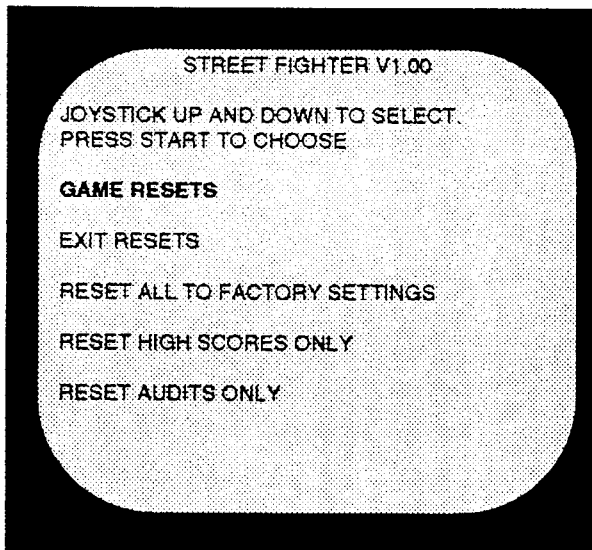

GAME RESETS SCREEN

RESET ALL TO FACTORY SETTINGS will change the game back to the game was pre-set when new. Any custom features, such as Free Play and Skill Levels, will be changed back to the original settings set at the factory.

RESET HIGH SCORES ONLY is used to erase all of the high scores stored in memory.

RESET AUDITS ONLY is used when all of your bookkeeping and statistics have been gathered from the Audits section and are no longer needed. If you like to gather all of your accounting information each week or after each collection, it is a good practice to reset all of the audits so your coin count will match the audit information.

ATTRACT MODE SOUNDS

This menu is used to adjust the sounds that are heard while the game is is not being played.

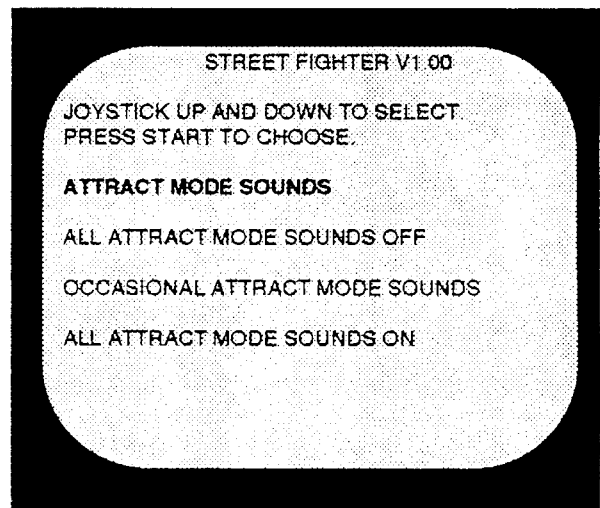

ATTRACT MODE SOUNDS MENU

ALL ATTRACT MODE SOUNDS OFF will not allow any sounds to be played during the attract mode.

OCCASIONAL ATTRACT MODE SOUNDS plays sounds about every ten to twelve times the attract mode is repeated.

ALL ATTRACT MODE SOUNDS will play sounds during every attract cycle.

CREDITS SETTINGS

This menu allows you to change the number of coins needed to play the game.

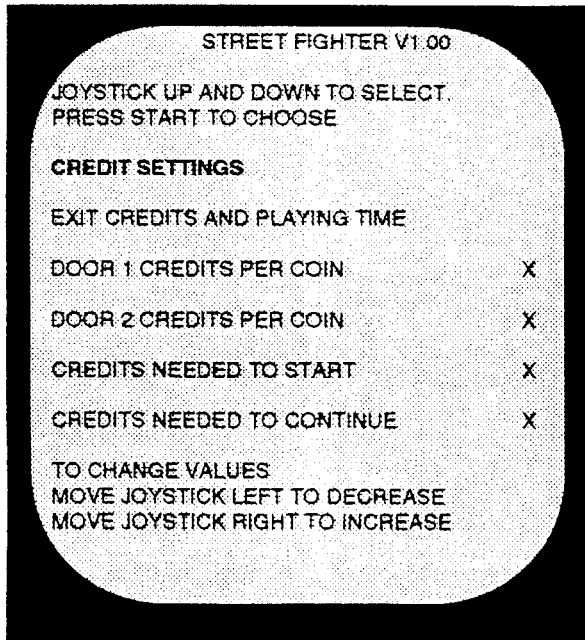

CREDIT SETTINGS SCREEN

You can set each coin door at different credit values by highlighting: **DOOR 1 CREDITS PER COIN** for coin door 1 or **DOOR 2 CREDITS PER COIN** for coin door 2. Moving the Player 1 joystick left or right will change the number of credits that each coin represents.

CREDITS NEEDED TO START will adjust the number of credits it takes for a player to begin a game. For example, the factory setting is 1 coin per credit but it takes 2 credits to begin a game. Therefore, two coins are needed to begin a game. If you want the number of credits needed to continue a game already in progress to be different than the number of credits needed for the initial game start, you can set the new value using **CREDITS NEEDED TO CONTINUE**.

VIOLENCE SETTINGS

Street Fighter: The Movie™ allows for a "no violence" setting or, if violence is desired, changing the various violent elements of the game.

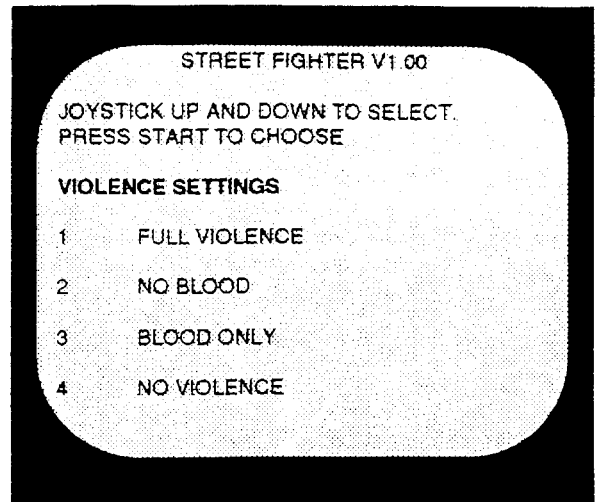

VIOLENCE SETTINGS SCREEN

SKILL LEVEL ADJUSTMENT

STREET FIGHTER : THE MOVIE™ allows for changing the level of skill needed to play the game. This feature is good for locations with younger or novice players who are less skilled at the game or accomplished players who demand a greater challenge.

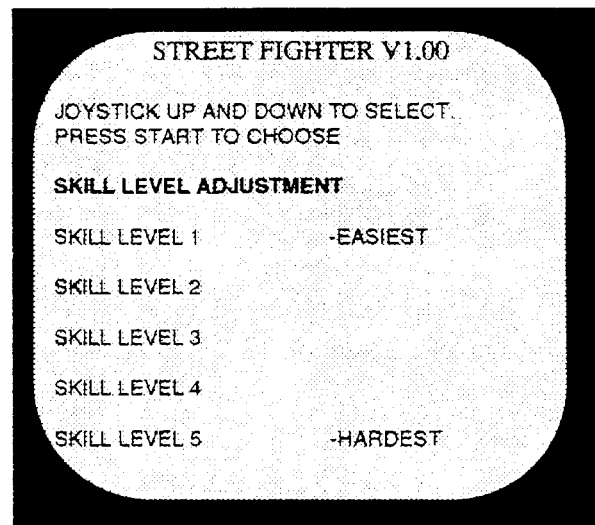

SKILL LEVEL ADJUSTMENT SCREEN

To set the game to an easy skill level, highlight "**SKILL LEVEL 1 - EASIEST**"; to set the game to a difficult skill level, highlight "**SKILL LEVEL 5 - HARDEST**". Skill levels 2, 3, and 4 are settings that should be adjusted gradually over a period of time.

HORIZONTAL SCREEN ADJUSTMENT

If for some reason the picture is not centered properly on the screen, use this menu to correct the problem.

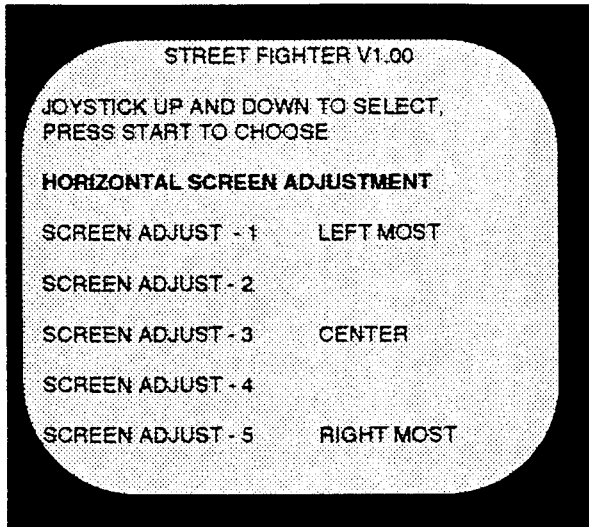

HORIZONTAL SCREEN ADJUSTMENT SCREEN

SCREEN ADJUST - 1 LEFT MOST

will move the picture far to the left.

SCREEN ADJUST - 3 CENTER

will attempt to center the picture on the monitor.

SCREEN ADJUST - 5 RIGHT MOST

will move the picture far to the right.

GAME AUDITS

The Game Audits section will supply you with a detailed accounting of helpful and informative bookkeeping and statistics. To enter the Audits section, first go to the Main Service Menu by pressing the test switch located just inside the coin door of the cabinet or DIP switch 1 to the OFF position on the PCB. From the Main Service Menu, move the Player 1 joystick down until the phrase **GAME AUDITS MENU** appears in white letters. Now press any player start button and the Game Audits menu appears on the screen.

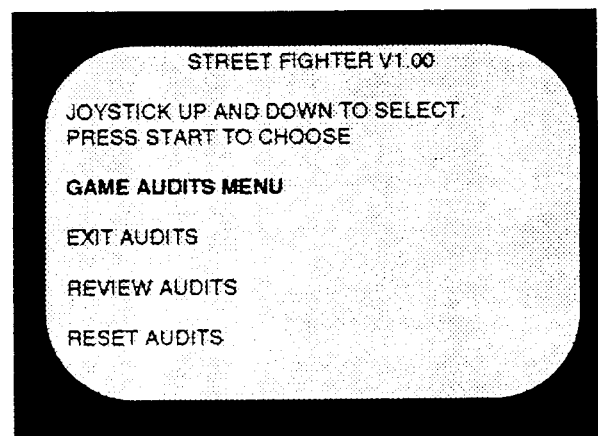

GAME AUDITS SCREEN

To look at the current statistics, highlight the **REVIEW AUDITS** and press any player start button.

To set all the statistics back to zero, highlight **RESET AUDITS** and press any player button.

REVIEW AUDITS

When you choose to review the audits, a series of four Audits Review Screens will appear. These are read-only screens that do not require the operator to make selections. By pressing any player start button, Audit Screen 1 will exit to Audit Screen 2. By again pressing the player start button, Audit Screen 2 will exit to Audit Screen 3. After reviewing Audit Screen 3, the operator may then access Audit Screen 4 by pressing the player start button. Finally, Audit Screen 4 will exit to the Game Audits Screen by again pressing the player start button.

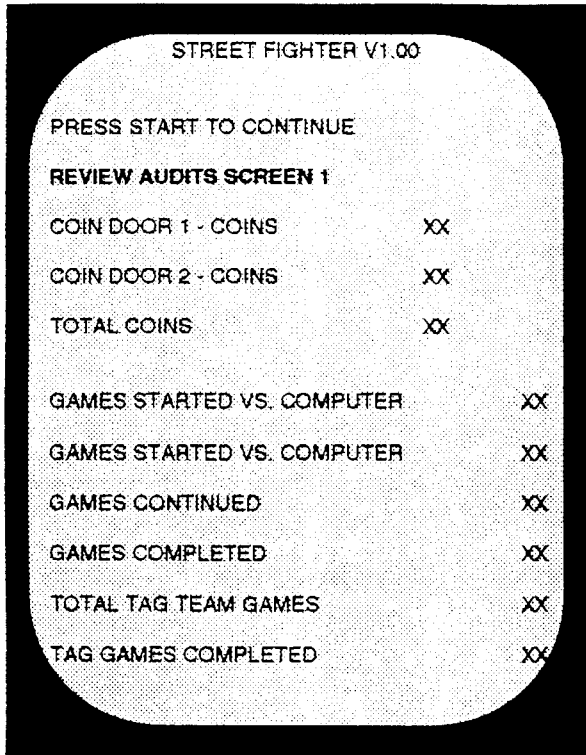

AUDITS REVIEW SCREEN 1

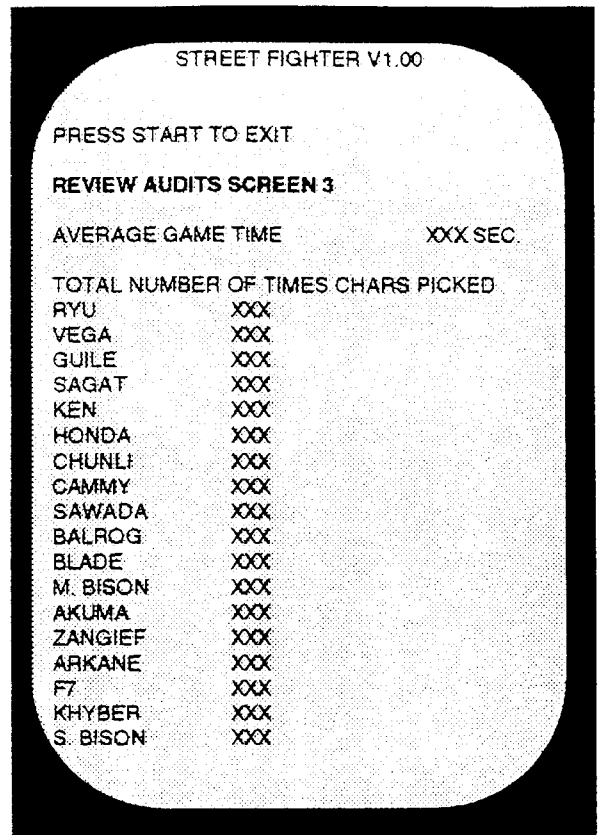

AUDITS REVIEW SCREEN 3

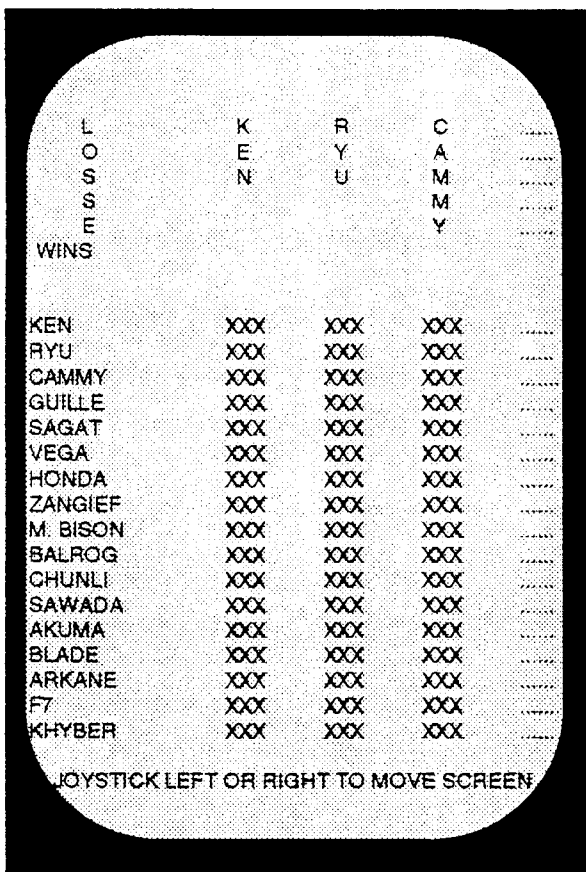

AUDITS REVIEW SCREEN 2

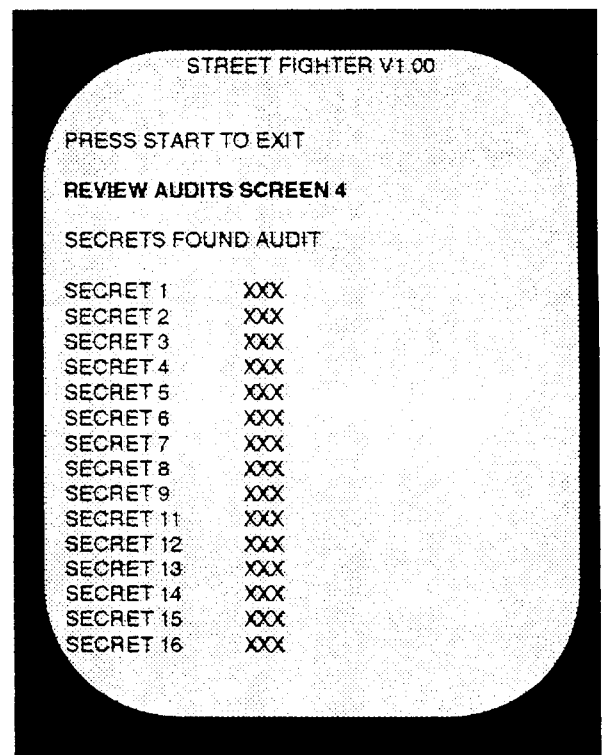

AUDITS REVIEW SCREEN 4

RESET AUDITS

When you choose to reset the audits, use the Game Resets Screen and select RESET AUDITS.

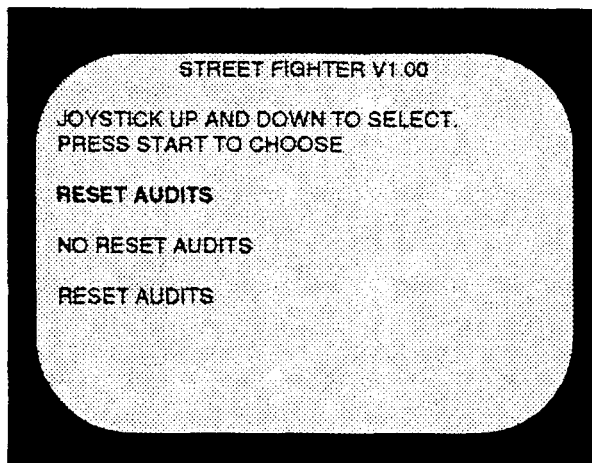

GAME RESETS SCREEN

If you wish to reset all of the game audits (described above) to zero, highlight **RESET AUDITS** from this menu and press any start button. The screen will briefly display AUDIT RESET.

If for some reason you wish to undo the RESET AUDIT function before you have left the the GAME RESETS SCREEN, highlight **NO RESET AUDITS** and press any player start button. This action allows you to exit the screen without having cleared the current audit values.

SYSTEM TESTS

If you are experiencing any problems with the operation of the game, the System Tests are an excellent troubleshooting tool. To enter the System Tests section, first go to the Main Service Menu by pressing the test switch located just inside the coin door of the cabinet, or set DIP switch 1 on the PCB to the OFF position. From the Main Service Menu, move any player joystick down until the phrase **SYSTEM TESTS MENU** appears in white letters. Now press any player start button and the System Tests Menu will appear on the screen.

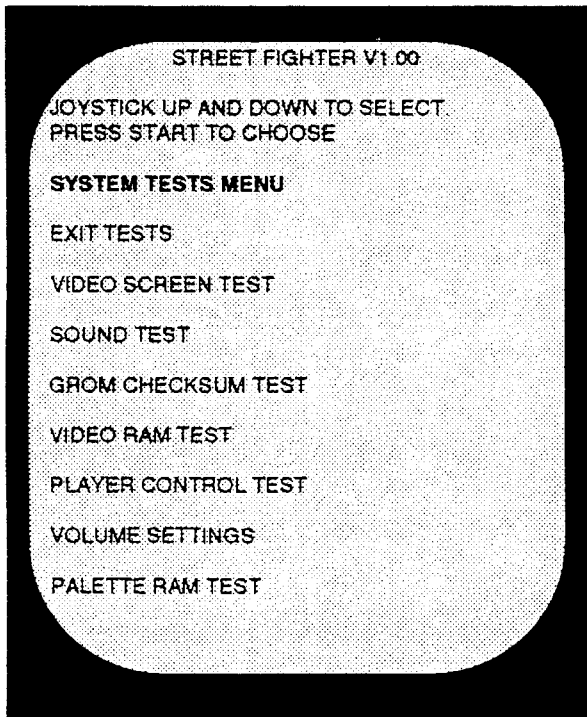

SYSTEM TESTS MENU

VIDEO SCREEN TEST

You can test your monitor and adjust colors by choosing **VIDEO SCREEN TEST** and pressing any player start button.

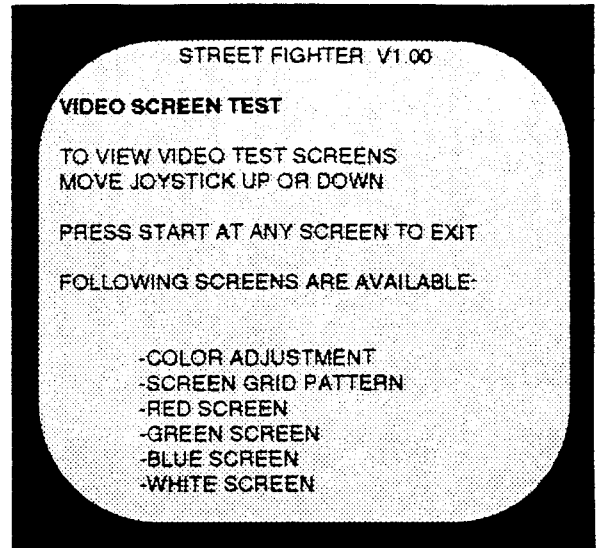

VIDEO SCREEN TEST MENU

When a player joystick is moved up or down, the screen changes to display a grid of colored rectangles. Use these colors as a guide and adjust your monitor so they look as good as possible. This test can be exited at any time by pressing any player start button.

SOUND TEST

Choose **SOUND TEST** from the System Test Menu to test the sounds and speakers in the game.

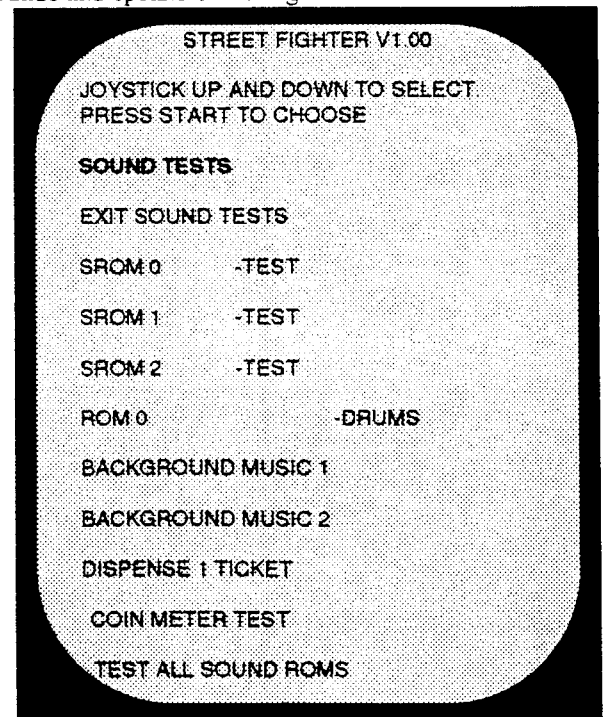

SOUND TESTS SCREEN

To test the coin meter, choose COIN METER TEST from this menu. Each time the player start button is pressed, you should observe the coin meter (located inside the coin box) incrementing.

GROM CHECKSUM TEST

Choose GROM CHECKSUM TEST from the System Test Menu to test the graphics chips on the PCB. This test performs a complete test of the graphic ROM's. While the test is in progress, the following message is displayed:

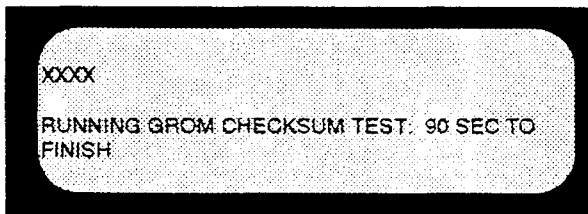

GROM TEST SCREEN (Test in Progress)

When the test is completed, the GROM Test Screen is displayed:

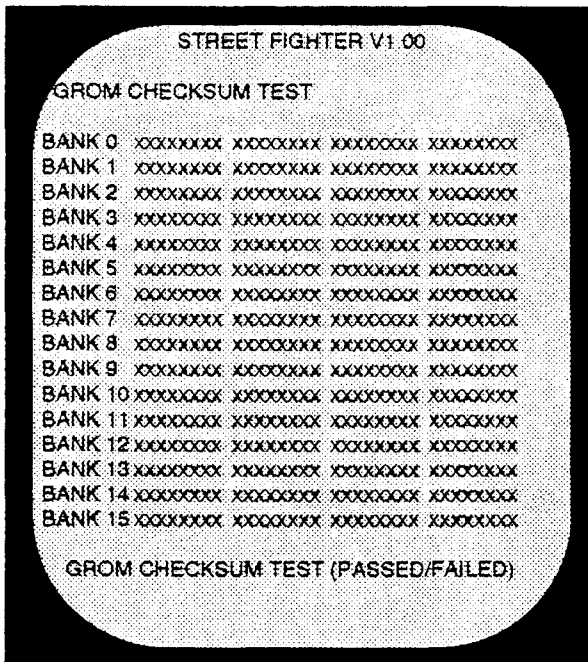

GROM TEST SCREEN (Test Completed)

1) If all checksums are shown in blue, the test passed and the game is in good working order.

- 2) If any checksums are bad, they will displayed in red text on this screen. This means that the GROM is defective and needs to be replaced. Call your distributor for further help.
- 3) To exit this test, press any player start button.

VIDEO RAM TEST

This test performs a complete test of the Graphics video RAM. The video RAM is tested in two pages. The following message will be displayed as each page is tested:

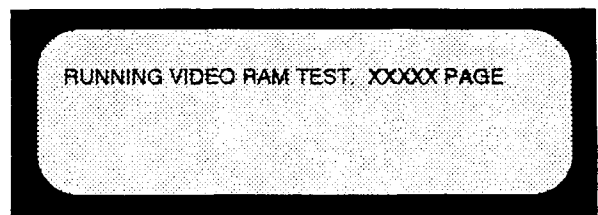

RAM TEST SCREEN (Test in Progress)

When the test is completed, the results will be displayed as follows:

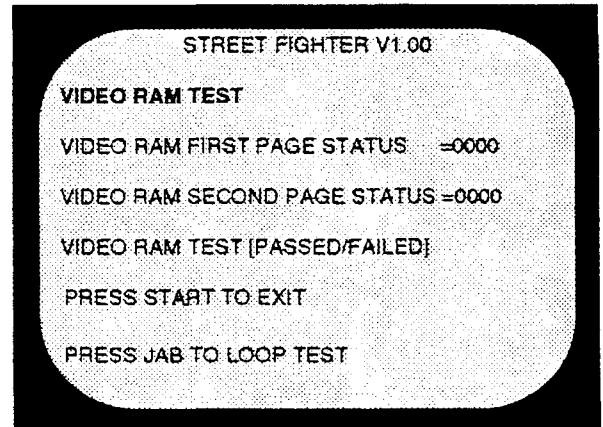

VIDEO RAM TEST SCREEN

- 1) If the game passes this test, zeros will be displayed in white along with a VIDEO RAM TEST PASSED message.
- 2) If the test fails, a non-zero status and VIDEO RAM TEST FAILED message will be displayed in red. Call your distributor for further assistance.
- 3) To exit this test, press any player start button.

PLAYER CONTROL TEST

Choose PLAYER CONTROL TEST from the System Test Menu to test the switches and controls of your game cabinet.

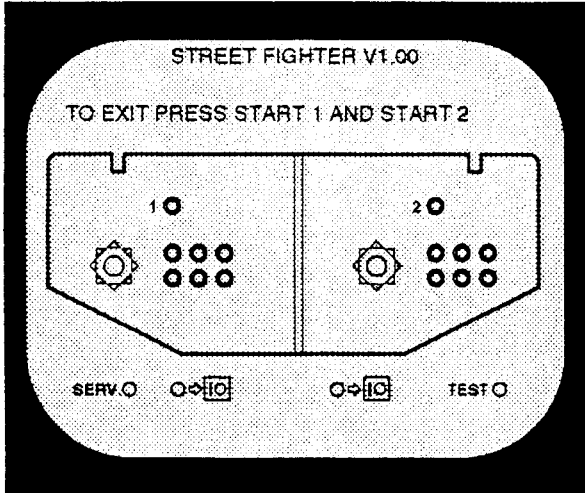

PLAYER CONTROL TEST SCREEN (6-Buttons)

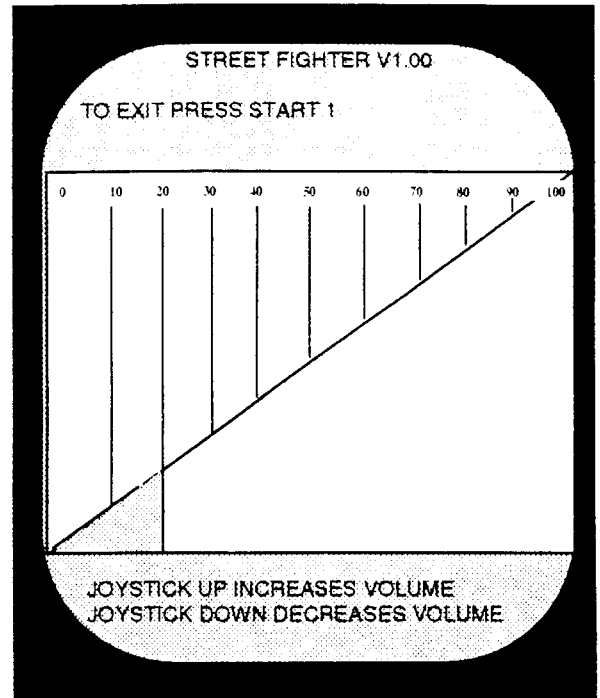

VOLUME SETTINGS SCREEN

- 1) The screen displays a graphic representation of the players' control layout. The screen should contain blue images of the Player #1 joystick, Player #1 Control buttons, and Coin Acceptor #1. Green images appear on the screen of the Player #2 joystick, Player #2 Control buttons, and Coin Acceptor #2. Lastly, gray images of the Start and Test buttons appear on the screen.
- 2) Images on the screen will change color when the control is activated. Coin slots can also be tested from this screen.
- 3) Pressing the Start or Test button will also be highlighted on the screen.
- 4) To exit the test, Player 1 and Player 2 Start buttons must be pressed at the same time.

VOLUME SETTINGS

To adjust the sound volume of the game, move the joystick up to increase the volume or move the joystick down to decrease the level of sound. For example, the following screen displays a user-selected Volume Setting of 20% :

PALETTE RAM TEST

The PALETTE RAM test performs read/write operations from the main CPU to the static RAMs to determine RGB conformity. Select PALETTE RAM TEST and press any player Start button to begin the test.

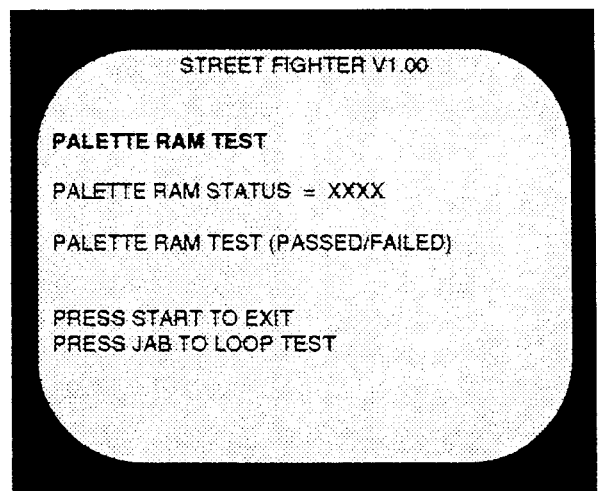

PALETTE RAM TEST SCREEN

NOTES

GENERAL TROUBLESHOOTING GUIDE

POWER-UP PROBLEMS

REF	SYMPTOM	POSSIBLE SOLUTION (S)
1	NO RESPONSE WHEN GAME IS TURNED ON	<p>Check A.C. line cord.</p> <p>Check the power supply switch is in the "on" position; also, check the circuit breaker for proper operation.</p> <p>Check the +5VDC, -5VDC, and +12VDC outputs of the power supply; replace power supply if any of these readings are not within spec.</p> <p>Check for a blown fuse on the motherboard PCB; replace if necessary, also, check the +5VDC supply voltage on the motherboard PCB; if it doesn't read between +5VDC and +5.2VDC, adjust power supply trim pot.</p> <p>Check the JAMMA harness for shorts, such as frayed wires or contact with bare metal; replace harness if required.</p> <p>Check for loose or foreign material on all PCB's.</p>
2	GAME WILL NOT BOOT; POWER-UP SOUNDS ARE REPETITIVE	<p>Check all PCB's for bent pins on socketed parts; re-align pins and seat IC's properly.</p> <p>Check the +5VDC supply voltage on the motherboard PCB; it doesn't read between +5VDC and +5.2VDC, adjust power supply trim pot.</p>
3	GAME BOOTS UP IN TEST MODE	<p>Check the position of DIP switch 1; it should be in the ON position for normal game play.</p>

CONTROL PROBLEMS

REF	SYMPTOM	POSSIBLE SOLUTION (S)
1	BUTTONS OR JOYSTICKS DO NOT WORK OR OPERATE INTERMITTENTLY	<p>Perform the Player Control Test to verify operation (refer to the System Tests section of this manual).</p> <p>Check the common post of the button switch for a good connection to ground.</p> <p>Check the normally "open" post of the button switch for a good connection to the signal wire.</p> <p>Check the button switch terminals with an ohmmeter.</p> <p>Check the wiring between the JAMMA connector and the particular button switch.</p>

GENERAL TROUBLESHOOTING GUIDE

CONTROL PROBLEMS (continued)

REF	SYMPTOM	POSSIBLE SOLUTION (S)
2	COIN METER INOPERATIVE	Check for +12VDC power on the "+" terminal of the meter switch. Check the continuity of the signal wire from the meter switch to the JAMMA connector.
3	SCREEN BLANKS OUT AND/OR GAME RESETS WHEN A COIN IS INSERTED	Check the junction resistance of the IN4004 diode on the coin meter harness receptacle.

VIDEO PROBLEMS

REF	SYMPTOM	POSSIBLE SOLUTION(S)
1	NO PICTURE	Check the position of DIP switch 4; it should be in the ON position for a negative sync monitor. Check all wiring connections from the motherboard PCB video outputs to the monitor's video inputs. Check the operation of the monitor by testing with another, compatible logic board.
2	NO RASTER/NO VIDEO	Check the A.C. line cord. Check the power supply switch is in the "on" position; also, check the circuit breaker for proper operation. Adjust the monitor brightness control.
3	RASTER/NO VIDEO	Check all motherboard PCB-to-monitor connections. Check power supply voltages on the motherboard PCB.
4	NO VIDEO (GAME SOUNDS CAN BE HEARD)	Adjust monitor brightness control. Check all motherboard PCB-to-monitor connections.
5	SCRAMBLED PICTURE	Check DIP switch 4 is in the ON position.

GENERAL TROUBLESHOOTING GUIDE

VIDEO PROBLEMS (continued)

REF	SYMPTOM	POSSIBLE SOLUTION (S)
6	MISSING COLORS, WRONG COLORS, OR A WASHED-OUT COLOR	<p>Check all red, green, and blue (RGB) connections on the video PCB.</p> <p>Check for proper wiring between the motherboard PCB and the monitor.</p> <p>Check all monitor adjustments; re-adjust as necessary.</p> <p>Degauss the monitor.</p>
7	BRIGHT, BLURRY, OR WAVY PICTURE	<p>Check monitor ground for proper connection to the monitor.</p> <p>Check sync inputs for proper connection to the monitor.</p> <p>Check horizontal hold adjustment; re-adjust as necessary.</p>
8	ROLLING PICTURE	<p>Check horizontal and/or vertical hold adjustments; re-adjust as necessary.</p> <p>Check sync inputs for proper connection to the monitor.</p>
9	PICTURE IS TOO LARGE, TOO SMALL, OR OFF-CENTER	<p>Check width and height adjustments; re-adjust as necessary.</p>
10	VIDEO IMAGE IS FLIPPED	<p>Change the position of DIP switch 3.</p> <p>Reverse the monitor's convergence wires (refer to the Monitor Appendix section of this manual).</p>
11	POOR IMAGES	<p>Perform GROM checksum test (refer to the System Tests section of this manual).</p>
12	DIAGONAL WHITE LINES	<p>Check earth and logic ground connections at the power supply.</p>

SOUND PROBLEMS

REF	SYMPTOM	POSSIBLE SOLUTION (S)
1	NO SOUND	<p>Check the volume setting of the game (refer to the System Tests section of this manual).</p> <p>Check speakers for an "open circuit" between the "+" and "-" terminals.</p> <p>Check the status LED on the sound PCB for a continuous flashing condition.</p> <p>Check power connections and voltage levels on the audio amplifier PCB.</p>
2	BAD SOUND	<p>Check speaker wiring.</p> <p>Check each speaker by replacing it with a known, working speaker.</p>

AUXILIARY JAMMA CABLE CONNECTIONS

CONNECTOR	WIRE COLOR	PIN	CONNECTS TO	LOCATION	FUNCTION
FEMALE SPADE	WHITE/VIOLET	-	CONTROL PANEL BUTTON SWITCH	-	PLAYER 1 - FIERCE
FEMALE SPADE	WHITE/GRAY	-	CONTROL PANEL BUTTON SWITCH	-	PLAYER 1 - SHORT
FEMALE SPADE	WHITE/BLACK	-	CONTROL PANEL BUTTON SWITCH	-	PLAYER 1 - FWD
FEMALE SPADE	VIOLET/BLACK	-	CONTROL PANEL BUTTON SWITCH	-	PLAYER 2 - FIERCE
FEMALE SPADE	VIOLET/GRAY	-	CONTROL PANEL BUTTON SWITCH	-	PLAYER 2 - SHORT
FEMALE SPADE	VIOLET/WHITE	-	CONTROL PANEL BUTTON SWITCH	-	PLAYER 2 - FWD
FEMALE SPADE	BLACK	-	CONTROL PANEL BUTTON SWITCH	-	GROUND
FEMALE SPADE	VIOLET	-	CONTROL PANEL BUTTON SWITCH	-	PLAYER 2- ROUNDHOUSE
FEMALE SPADE	WHITE	-	CONTROL PANEL BUTTON SWITCH	-	PLAYER 1- ROUNDHOUSE
SNAP-IN PIN	VIOLET/BLACK	-	MOTHERBOARD PCB	JAMMA 'b'	PLAYER 2 - FIERCE
SNAP-IN PIN	VIOLET/GRAY	-	MOTHERBOARD PCB	JAMMA 'c'	PLAYER 2 - SHORT
SNAP-IN PIN	VIOLET/WHITE	-	MOTHERBOARD PCB	JAMMA 'd'	PLAYER 2 - FWD
SNAP-IN PIN	WHITE/VIOLET	-	MOTHERBOARD PCB	JAMMA '24'	PLAYER 1 - FIERCE
SNAP-IN PIN	WHITE/GRAY	-	MOTHERBOARD PCB	JAMMA '25'	PLAYER 1 - SHORT
SNAP-IN PIN	WHITE/BLACK	-	MOTHERBOARD PCB	JAMMA '26'	PLAYER 1 - FWD
3-PIN MOLEX	WHITE	1	MOTHERBOARD PCB	JP12	PLAYER 1- ROUNDHOUSE
3-PIN MOLEX	BLACK	2	MOTHERBOARD PCB	JP12	GROUND
3-PIN MOLEX	VIOLET	3	MOTHERBOARD PCB	JP12	PLAYER 2- ROUNDHOUSE
4-PIN MOLEX	RED/GRAY	1	SOUND PCB	JP5	LEFT SPEAKER (+)
4-PIN MOLEX	RED/BLACK	2	SOUND PCB	JP5	LEFT SPEAKER (-)
4-PIN MOLEX	GREEN/GRAY	3	SOUND PCB	JP5	RIGHT SPEAKER (+)
4-PIN MOLEX	GREEN/BLACK	4	SOUND PCB	JP5	RIGHT SPEAKER (-)
FEMALE SPADE	RED/BLACK	-	CABINET	-	LEFT SPEAKER (-)
FEMALE SPADE	RED/GRAY	-	CABINET	-	LEFT SPEAKER (+)
FEMALE SPADE	GREEN/BLACK	-	CABINET	-	RIGHT SPEAKER (-)
FEMALE SPADE	GREEN/GRAY	-	CABINET	-	RIGHT SPEAKER (+)

JAMMA HARNESS CONNECTIONS

WIRE COLOR	COMPONENT SIDE			SOLDER SIDE	WIRE COLOR
	GND	A	1	GND	
	GND	B	2	GND	
	+5 VDC	C	3	+5 VDC	
	+5 VDC	D	4	+5 VDC	
	-5 VDC	E	5	-5 VDC	
	+12 VDC	F	6	+12 VDC	
	KEY	H	7	KEY	
	COIN COUNTER 2	J	8	COIN COUNTER 1	
	COIN LOCK 2	K	9	COIN LOCK 1	
	* LEFT SPEAKER (-)	L	10	*LEFT SPEAKER (+)	
	* RIGHT SPEAKER (-)	M	11	*RIGHT SPEAKER (+)	
	VIDEO GREEN	N	12	VIDEO RED	
	VIDEO SYNC	P	13	VIDEO BLUE	
	SERVICE 1	R	14	VIDEO GND	
	TILT SWITCH	S	15	TEST MODE	
	COIN 2	T	16	COIN 1	
	START 2	U	17	START 1	
	PLAYER 2 - UP	V	18	PLAYER 1 - UP	
	PLAYER 2 - DOWN	W	19	PLAYER 1 - DOWN	
	PLAYER 2 - LEFT	X	20	PLAYER 1 - LEFT	
	PLAYER 2 - RIGHT	Y	21	PLAYER 1 - RIGHT	
	PLAYER 2 - JAB	Z	22	PLAYER 1 - JAB	
	PLAYER 2 - STRONG	a	23	PLAYER 1 - STRONG	
**VIOLET/BLACK	PLAYER 2 - FIERCE	b	24	PLAYER 1 - FIERCE	**WHITE/VIOLET
**VIOLET/GRAY	PLAYER 2 - SHORT	c	25	PLAYER 1 - SHORT0	**WHITE/GRAY
**VIOLET/WHITE	PLAYER 2 - FWD	d	26	PLAYER 1 - FWD	**WHITE/BLACK
	GND	e	27	GND	
	GND	f	28	GND	

- * SPEAKER CONNECTIONS ARE MADE THROUGH THE SOUND PCB; SUPPLY WIRES ARE INCLUDED WITH THE AUXILIARY JAMMA CABLE INCLUDED IN THIS KIT (SEE CHART FOR CONNECTION INFORMATION)
- ** YOU MUST REMOVE THESE PIN CONNECTIONS FROM YOUR EXISTING JAMMA CONNECTOR AND INSTALL THE SNAP-IN PINS SUPPLIED WITH THE AUXILIARY JAMMA CABLE (SEE CHART FOR DETAILS)

DIP SWITCH SETTINGS

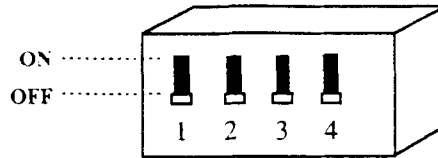

1) MOTHERBOARD PCB

SWITCH #	ON	OFF
1	NORMAL PLAY MODE	TEST MODE
2	NORMAL SCREEN	SCREEN FREEZE
3	SCREEN UPRIGHT	SCREEN FLIP
4	NEGATIVE VIDEO SYNC (-)	POSITIVE VIDEO SYNC (+)

NOTE: ALL OF THE ABOVE SWITCHES ARE NORMALLY ON

2) VIDEO ROM PCB (NOT USER CONFIGURABLE)

SWITCH #	ON	OFF
1	FACTORY PRESET	UNDEFINED
2	FACTORY PRESET	UNDEFINED
3	UNDEFINED	FACTORY PRESET
4	UNDEFINED	FACTORY PRESET

FUSE INFORMATION

REF	LOCATION	DESCRIPTION	CAPCOM® P/N
F1	MOTHERBOARD PCB	FAST-ACT 2.5A 250V TYPE 3AG	FS00103-025

NOTES

NOTICE

This equipment has been tested and found to comply with the limits for a Class A digital device, pursuant to Part 15 of the FCC Rules. These limits are designed to provide reasonable protection against harmful interference when the equipment is operated in a commercial environment. This equipment generates, uses, and can radiate radio frequency energy and, if not installed and used in accordance with the instruction manual, may cause harmful interference to radio communications. Operation of this equipment in a residential area is likely to cause harmful interference, in which case the user will be required to correct the interference at his own expense.

CAPCOM[®] COIN-OP, INC.

3311 N. Kennicott

Arlington Heights, Illinois 60004

Phone: (708) 797-6100 Fax: (708) 797-6306