

# CONTRAPTION ZACK™

## Employee Handbook



---

## Copyrights and Trademarks

This program is licensed for use only in accordance with the accompanying license agreement and limited warranty.

Copyright© 1992 Presage Software Development.  
Copyright© 1992 The Software Toolworks, Inc. All rights reserved.

Contraction Zack is a trademark of The Software Toolworks, Inc. IBM is a registered trademark of International Business Machines Corp. Amiga is a registered trademark of Commodore - Amiga, Inc. Mindscape and logo are registered trademarks of Mindscape Inc. The Software Toolworks is a registered trademark and its logo is a trademark of The Software Toolworks, Inc.



**Table of Contents**

Introduction .....4

Primary Machines and Systems .....5

Spikes, Buttons and Switches .....12

Transport and Access Devices.....14

Access Gates .....16

The Tool Box.....18

Repairing Components and Transistors.....21

Summary.....24



## Introduction

Dear New Employee,

Welcome aboard! We congratulate you on your first day on the job at Gadgetco, Inc., Plant No.4. We hope that you will be successful as the plant's Electro Mechanical Technician, and that you find the position responsibilities listed below both satisfying and challenging.

### POSITION:

Electro Mechanical Technician

### RESPONSIBILITIES:

- Keeping all Primary Machines & Operating Systems running efficiently.
- Resetting all plant Timing Mechanisms. (TMs)
- Maintaining and operating all Transport and Access Devices. (TADs)
- Repairing or replacing malfunctioning Components and Transistors.
- Getting the Master Machine working by the end of the day.

Our plant No.4 has been designed with the most sophisticated, up-to-date technology in the world. The following chapters will guide you through the easy-to-maintain & quick-to-repair environment of this facility.

At Gadgetco, Inc., the Golden Rule is team work. You can always rely on the support of your fellow workers. Good luck, and once again, welcome aboard!

Sincerely,

*B.S. Flanagan*

B.S. Flanagan

cc: A.D. Nauseam

## Primary Machines and Systems

**T**HE PLANT relies on six Primary operating systems that must be running efficiently to utilize the energy generated by the Primary Machines (PM) on each floor. For maximum efficiency the Electro Mechanical Technician (EMT) must keep the operating systems and the primary machines running between MV7 and MV8 diode rates. This is especially true under higher kelitic bore rates. The primary machines below are responsible for driving the functions of the Master Machine.

### Water Reservoir/P.M.1

The water reservoir system provides needed Friction Inhibitors or FIBS to the progressive balsamic oil lines enabling lubrication of all phalanx resistors. All Holding Tank Planks (diagram 1, fig. #682V) must be securely fitted into the High Pressure Plates (fig. #784Z) before the main valve (fig. #913H) can be safely engaged. When resetting timing mechanisms be sure that all access paths are cleared, and tools are secured before initiating final phase of the water reservoir system test.

WATER RESERVOIR

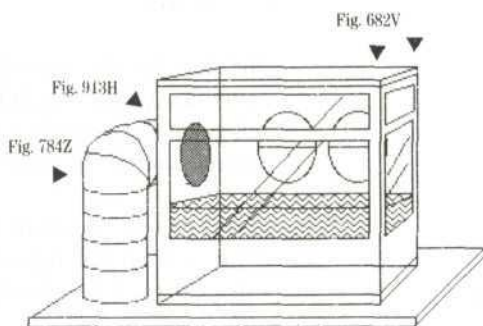
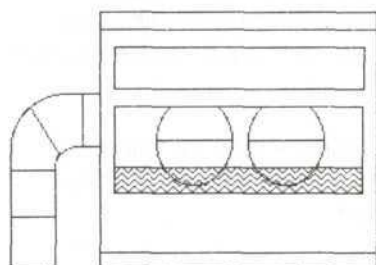

### Pump/P.M.2

The pumping system regulates the flow and pressure to all the hydraulic and hydrolytic fusion complexes. It is here that the heavy fluids are forced through the pressurized sprockets (diagram 2, fig. #73G) enabling the major pathways to spew freely. The relief cycle is then engaged as the particle filters (fig. #81L) screen the corrosive isotopes that can corrupt pipe linings. Particle screen boxes (fig. #91H) must be cleaned at regular intervals, and are located under the reinforced floor plates in the southwest corner of every level.

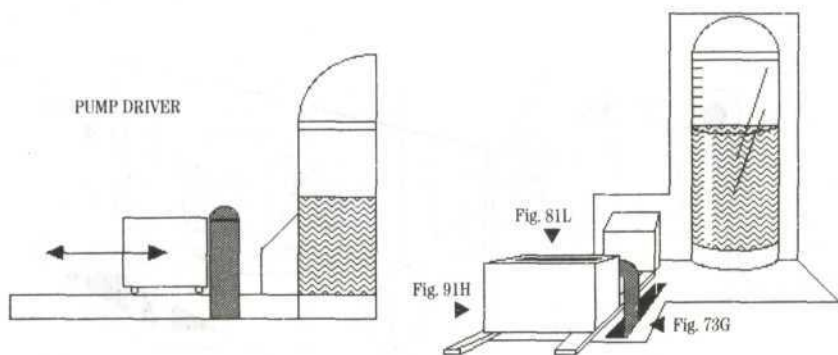

### Feeder/P.M.3

The feeder system launches and cuts power to the primary electric friction generator. An ancillary function of the feeder system is to dispose of excess glutinous enzymes. All magnetos and circuit terminals must be lubricated with company issued Lubricant Oil #Y940 at the center of their generator rotor joints (diagram 3, fig. #59H). The flow-temperature of the glutinous enzymes must be at a constant 104 degrees to eliminate clogging of waste paths.

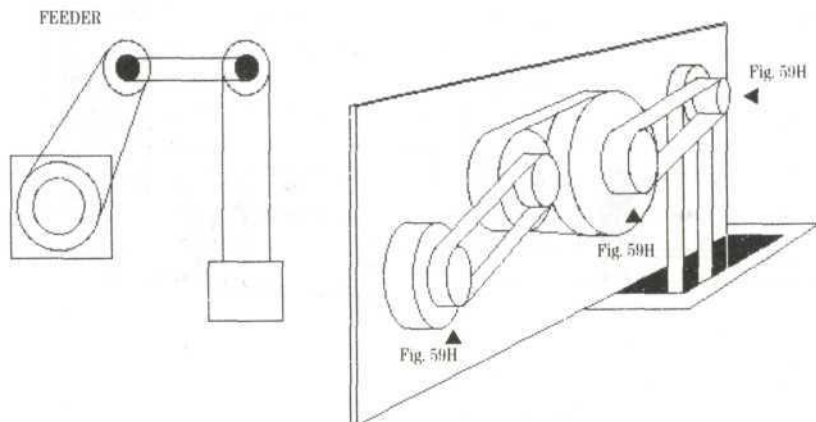



### Cutter/P.M.4

The cutter system restores normal system efficiency and is sometimes coupled with the central molar gear (diagram 4, fig. #991) to improve incisor and bicuspid mastication rates. The cutting surfaces of the incisor and bicuspid blades (fig. #002) should have a density reading of 5.993 kilo grams per cubic centimeter, even though both devices are pitched at opposing angles of 60 degrees. Daily maintenance of the molar gear housing (fig. #990) and bushings will eliminate static drag.

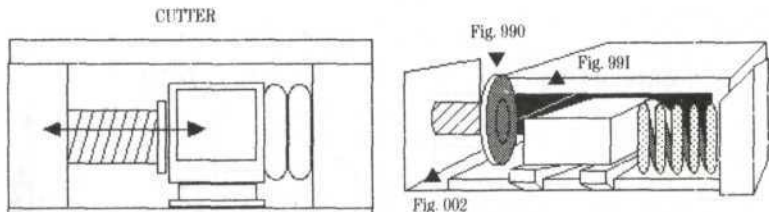

### Conveyor/P.M.5

The conveyor system freely transports and regulates the crystalline boron compound mix to the davit, enabling proton formulas to pass freely through the converter pathways (diagram 5, fig. #B4I). The conveyor system also connects all the external primary machine functions that enable the Master Machine to produce the finished product. The conveyor belt wire-modules (fig. #B67) are located behind the central rollers. These wire-modules should be replaced at regular intervals or each time the conveyor belt is serviced according to manual specifications.

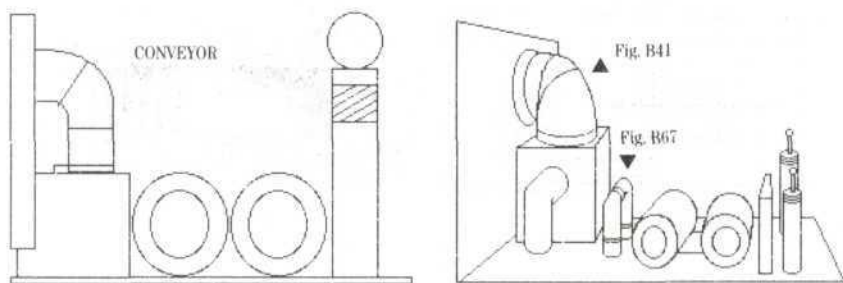

**Stomper/P.M.6**

The stomper system or STMS ensures overall current balance between the networks of voltage synthesizers (diagram 6, fig. #6JR). Maximum STMS performance regulators are activated before and after the introduction of every isotopical element. The preflush chemical solutions must have a pH reading (fig. #6JS) no higher than +12 to activate the isotopic elements that convey the proper voltage levels to the Master Machine.

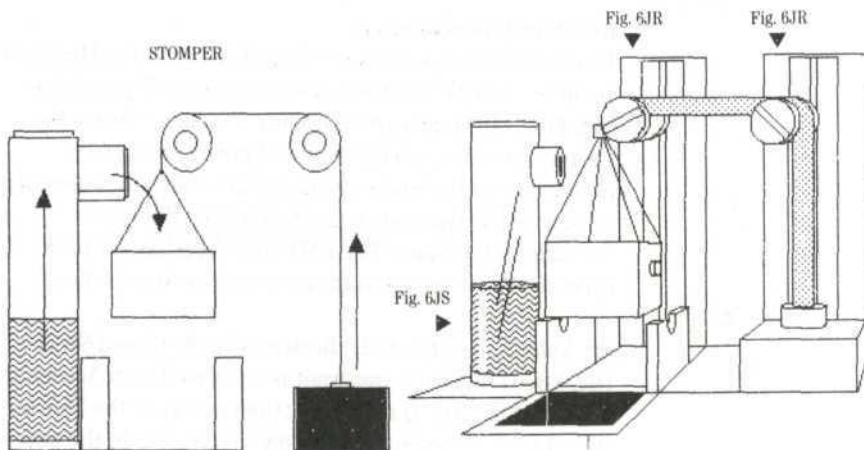

### **Timing Mechanisms**

Now that the Primary Machines and Operating Systems have been fully explained, we can move on to Timing Mechanisms (TMs). The TMs regulate the flow of electricity, hydro-fluids, lubricating petrochemicals, resource materials, and mechanical parts between the PMs and OSs. They are crucial to the quality of the finished product, and must be reset properly on all floors of the plant before the Master Machine initiation.

### **Resetting Mechanisms**

To successfully accomplish this task, the Electro Mechanical Technician (EMT) must depress buttons or flip switches (fig. #B13) in the proper sequence to raise or lower the various sets of color-coordinated Spikes. The correct positioning of the Spikes will automatically reset sensitive timing mechanisms above and below the floor level throughout the plant. The EMT will often have to lower specific sets of spikes to gain access to a room or floor.

☛ *Note:* Spike (fig. #V9), Buttons (fig. #3-6) and Switch (fig. #B13) functions must not be confused with Access and Transport devices (i.e. Gates & Conveyors). If the TMs are reset properly, Spikes will not prevent access to the pathways.

**Spikes, Buttons and Switches**

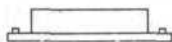

Fig. 3

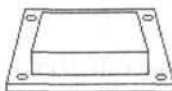
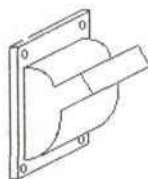

Fig. 4  
SQUARE  
BUTTONS



BASIC SWITCH  
Fig. B13

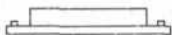

Fig. 5

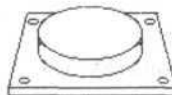
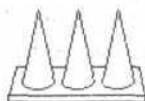

Fig. 6  
ROUND  
BUTTONS



TIMING SPIKES  
Fig. V9

**Retro Hydrolating Spikes / Buttons (Blue)**

Resets the phalanx resistor timing node's vertical pitch to 40 degrees to accurately regulate the release of FIBS through the hydraulic ducts.

**Auxiliary Pressure Spikes / Buttons (Purple)**

Resets all microsecond pressure release fittings so that sprockets routinely adjust to the various thicknesses of the hydrolitic fusion complexes.

**Voltage Power Reduction Spikes / Buttons (Orange)**

Resets all voltage regulators (housed under circuit C boards) to the proper feed rates while all systems are working at maximum performance levels.

**Ancillary Density Spikes / Buttons (Yellow)**

Resets the measuring device clocks that record the density of the incisor and bicuspid blade surfaces in kilograms per cubic centimeters.

**Trans Relay Spikes / Buttons (Green)**

Resets traffic sensors that determine the mix of crystalline boron levels in formulas passing through the converter pathways.

**Tertiary Generator Spikes / Buttons (Gray)**

Resets critical isotope meters that scan for irregular pH levels in voltage transported to the Master Machine receptors.

## Transport and Access Devices

**T**ADs control the operation of all plant entrance, exit, and access functions. They also control device drivers above and below floor level that move people or materials through the pathways. (e.g. the electronic eye transistors regulate photo-zircal recognition to the thermo sensor pads determining electronic gate pressure and conveyor belt speed settings.) The plant access and transport devices are:

### Launch Plates

These devices provide quick easy transport from one area of the plant to another through the use of highly compressed spring mechanisms (fig. #78H). Make sure the bottom of your work boots are free of any lubricants before stepping onto plates.

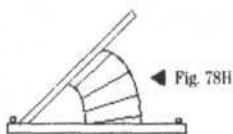

LAUNCH PLATE



### Conveyor Belts

These belts were designed to move heavy materials (fig. #71K) from place to place on rollers wrapped in belts of nylon & titanium fabric. These conveyor belts can also be adjusted to move materials in either direction.

CONVEYOR BELT

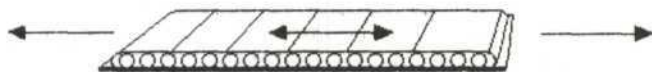

Fig. 71K

## Elevators

Plant 4 elevators types are:

Heavy Load Freight. (fig. #21A)

Gated Ferry Lifters. (fig. #22A)

Flush with Floor Single Man. (fig. #23A)

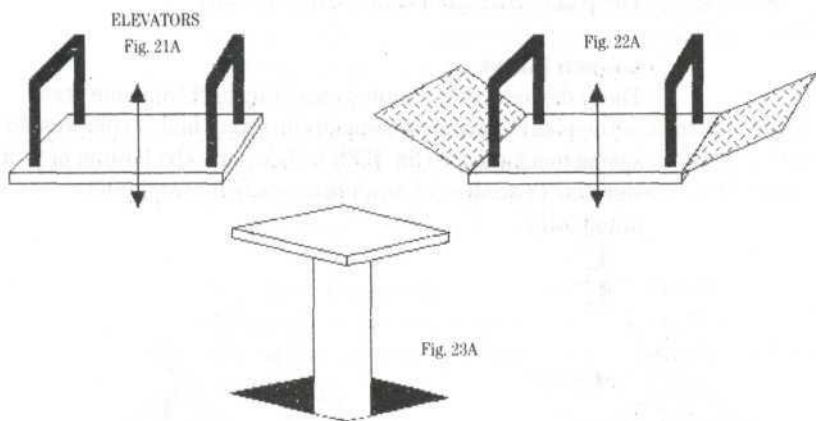

## Hydra Valves

Hydra valves (fig. #76X) are used to transport and redirect large volumes of water used to cool or lubricate various plant components.

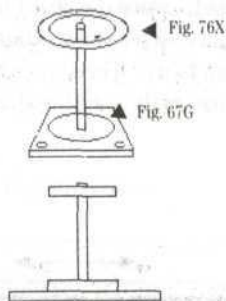



## Access Gates

**T**HERE ARE many different kinds of access gates throughout the plant. All plant gates are electronically controlled to open and close through the use of electric eyes, switches, and floor plates. The plant access gates are:

1. Horizontal Wedge Gates (fig. #7Y8)
2. Cube Gate (fig. #17N)
3. Vee Gate (fig. #7Y9)
4. Electric Gate (fig. #47Q)
5. Cyclone Mesh Gate (fig. #12B)

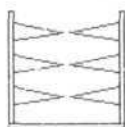

▲  
HORIZONTAL  
SPIKE GATE  
Fig. 7Y8

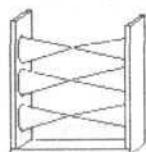

▶  
CUBE GATE  
Fig. 17N

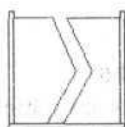
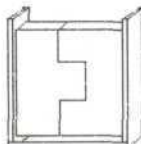

▲  
VEE GATE  
Fig. 7Y9

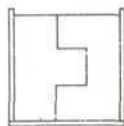
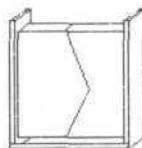

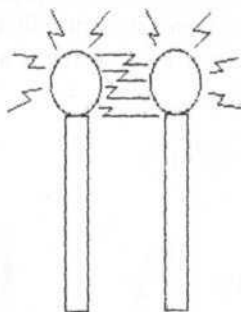

ELECTRIC GATE  
Fig. 47Q

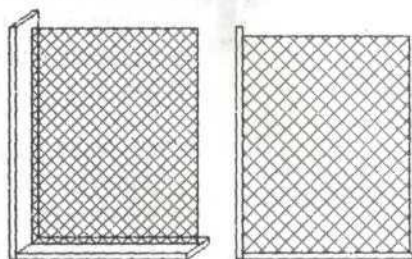

CYCLONE MESH GATE  
Fig. 12B

### Rafts

Rafts are stationary floating devices (fig. #88J) that automatically activate when the hydra valves are deployed. They enable direct access to areas that would otherwise be cut off by water flow.

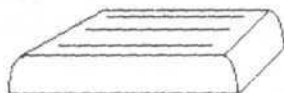

RAFT  
Fig. 88J

## The Tool Box

**Y**OU HAVE been issued the Super Deluxe Gadgetco, Inc. Tool Box 39C containing 9 state-of-the-art tools. These tools are indispensable for completing your assigned tasks. The tools are of the highest quality. Gadgetco, Inc. contracted the same Tool & Die manufacturer used by the Pentagon. You need these tools throughout the plant, and must have them in your possession at all times. No tools should ever be left in the plant. EMTs will be held financially responsible for lost or damaged tools. The following list provides a description, function, and the replacement cost (RP) for each tool in your possession.

### The 9 tools are:



Fig. 5B6 ← Fig. 5B9



Fig. 10Z



Fig. 7R8 ← Fig. 7R1



Fig. 7N5



Fig. 7R7 ← Fig. 7R1



Fig. 6R9  
Fig. 6R3



Fig. 7N7 ← Fig. 7N9



Fig. 4C3 ← Fig. 4C9



Fig. 30Z ← Fig. 30Z

### **1. Titanium Screwdriver**

The screwdriver (fig. #5B6) fitted with non-slip heavy vinyl hand-grips (fig. #5B9) is used for loosening, tightening, and inserting "screws." Replacement Cost - \$850.00

### **2. Barbed Wire Cutter**

The barbed wire cutters (fig. #10Z) are coated with precise pressure hand-grip sensors (fig. #10X), and are used for cutting wires when Primary Systems malfunction and must be temporarily disabled. Replacement Cost - \$450.00

### **3. Robotic Pipe Wrench**

The tungsten steel robotic pipe wrench (fig. #7R8) is fitted with robotic auto self-adjusting chips (fig. #7R1) that apply the exact torque necessary to remove pipes without stripping threads. Replacement Cost - \$1376.00

### **4. Silicon Tape**

The silicon tape (fig. #7N5) is designed to insure maximum conduction of electric current. Silicon tape also withstands extremely hot temps. Used to secure wire in modules. Replacement Cost - \$199.00

### **5. Pipe**

The pipe (fig. #7R7) with poly-adhesion corrosion-proof thread coverings (fig. #7R1) guarantees instant sealing & easy removal. Used as re-usable replacement for plant pipework. Replacement Cost - \$317.00

### **6. Hexnut Wrench**

The hexnut wrench (fig. #6R3) is used for tightening all hexnut plates in the plant (see pg.22, fig. #6R2). The diamond cut hexagon fitting (fig. #6R9) is designed for 100 years of accuracy. Replacement Cost - \$900.00

### **7. Catalytic Wire**

The catalytic wire (fig. #7N7) forged with poly alloy inhibitors (fig. #7N9) is almost guaranteed to withstand mega voltage overloads. Used to replace failed wire in modules (fig. #7N4).  
Replacement Cost - \$327.00

### **8. Oil Can**

The oil can (fig. #4C3), made of high density chromium plated steel contains oil #Y940 with high volume applicator (fig. #4C9) used for lubricating Oil Plates (fig. #4C2).  
Replacement Cost - \$629.00

### **9. Hammer**

The hammer (fig. #20Z) with gyro-centering head (fig. #30Z) is used throughout the plant to gently persuade components to function. Replacement Cost - \$629.00

## Repairing Components and Transistors

**E**VEN THOUGH Plant No.4 is equipped with the most up-to-date technology, there will still be some occasions when components and transistors do fail. Below please find the recommended Repair Procedure (RP) for fixing components and transistors.

### Wire Module

The fuse-like components (fig. #7N4) occasionally fail when the primary machines redirect mega masses of voltage, causing wire modules to fail (fig. #8U7).

☛ RP: Remove failed wire module (fig. #8U7), and replace with wire module from toolbox (fig. #7N7), then secure in place with Tool Box Silicon Tape (fig. #7N5).

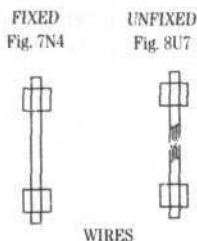

### Pipework

Pipe failure is due to dirty particle screen boxes in the PM2 (page 6, fig. #81L). Isotopes corrode pipe linings resulting in pipe failure under high pressure (fig. #7R6).

☛ RP: Remove corroded pipe (fig. #7R6) with Tool Box Pipe Wrench (fig. #7R8) and replace with Tool Box Pipe (fig. #7R7).

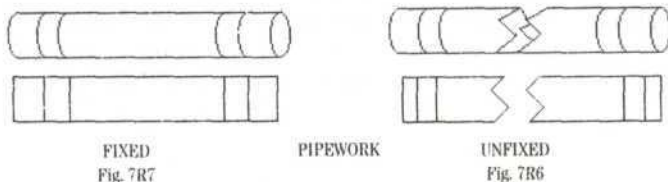

### Screw Plates

Due to machine vibration, Screw Plates must be routinely tightened in the fixed position (fig. #5B3).

➤ RP: Tighten loose Screw Plates (fig. #5B4) with Tool Box Titanium Screwdriver (fig. #5B6).

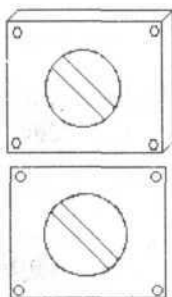

FIXED  
Fig. 5B3

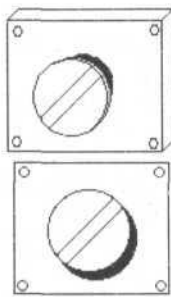

UNFIXED  
Fig. 5B4  
SCREWPLATE

### Hexnut Plates

Hexnut failures (fig. #6R2) due to metal fatigue will raise hexnuts out of cylinder tracks disengaging Access Systems.

➤ RP: To repair broken Hexnut Plate turn Hexnut Wrench (fig. #6R3) counter clock-wise until Hexnut is depressed (fig. #6R4).

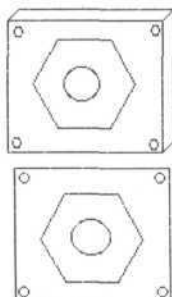

FIXED  
Fig. 6R4

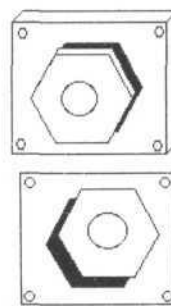

UNFIXED  
Fig. 6R2  
HEXNUT

### Oil Plates

Plant Oil Plates need to be routinely lubricated with Oil #Y940. Plate meters will indicate when lubrication is needed (fig. #4C2).

➤ RP: Use Oil Can #Y940 (fig. #4C3) to lubricate Oil Plate until meter registers full. (fig. #4C4).

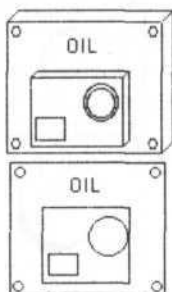

FIXED  
Fig. 4C4

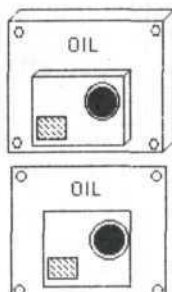

UNFIXED  
Fig. 4C2  
OIL





## Summary

You have been fully briefed on all the internal workings of Plant No.4. We are confident that you will be able to maintain this facility and keep your job by getting the Master Machine working in time for the head office inspection. Good luck—no pressure intended.

## Technical Support

### USA

Mindscape Inc.  
A Software Toolworks Company  
60 Leveroni Court  
Novato, CA 94949

Telephone: (415) 883-5157  
Fax: (415) 883-0367

### Europe

Mindscape International  
P.O. Box 51  
Burgess Hill RH15 9FH  
West Sussex, England, UK

Telephone: (0) 444 239-600  
Fax: (0) 444 248-996

### Australia, New Zealand

Mindscape International  
5/6 Gladstone Road  
Castle Hill, New South Wales  
Australia 2154

Telephone: (02) 899-2277  
Fax: (02) 899-2348



The Software Toolworks, Inc.

60 Leveroni Court

Novato, CA 94949

415/ 883-3000

