

SUNRACER OWNER'S GUIDE

AND NAVIGATION MANUAL

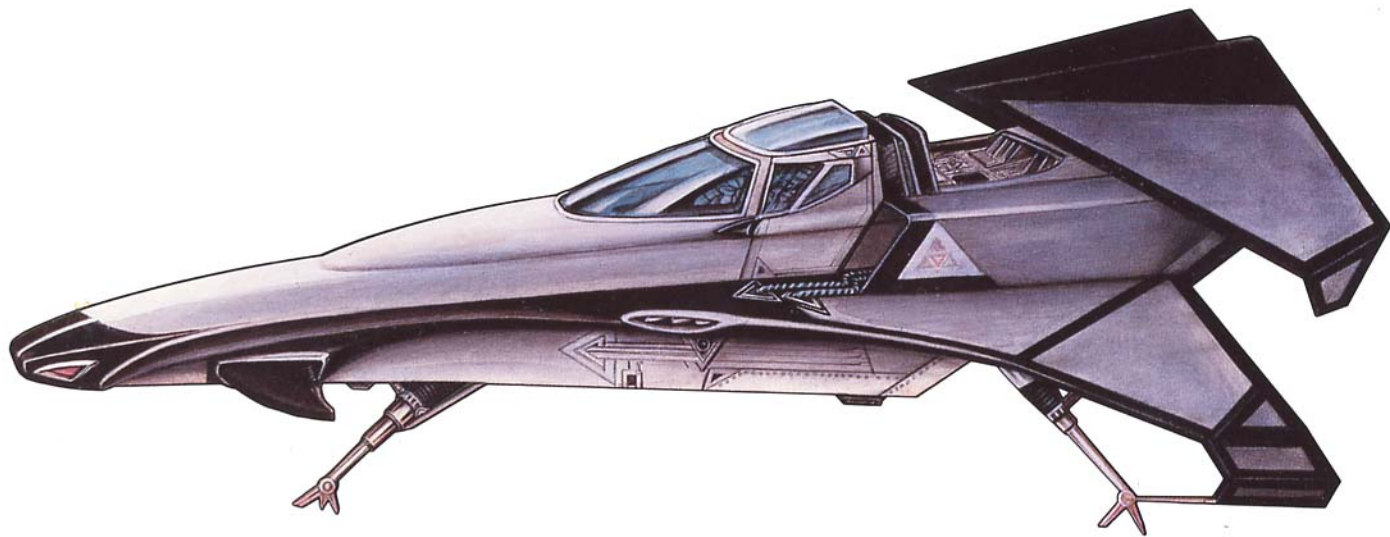

<http://www.replacementdocs.com>

The Making of Space Rogue™ ...

Paul Neurath was planning a sophisticated 3D flight simulation when he started developing *Space Rogue* in 1987. In fact, his first year was spent polishing the flight dynamics and solid, filled 3D graphics to create a truly accurate simulation of space flight. While he succeeded in that original quest, his vision of the game soon changed — or perhaps was changed for him.

“*Space Rogue* seemed to take on a life of its own,” said Paul, “and I realized it would have to become a role-playing game embedded in a space flight simulation. It was the only way to provide a full spectrum of experiences for the game player — to immerse them in a universe where economics, culture, politics and technology affect the course of events.”

The most difficult aspect of development was to make the 3D simulation work efficiently with 6502 processors and only 64K of memory. Only slightly less demanding was trying to seamlessly integrate the role-playing and simulation game elements.

Sophisticated entertainment software development is no longer a solitary endeavor, and *Space Rogue* is no exception. Only the special talents of ORIGIN's professional team of producers, graphic artists, programmers and sound engineers made such a trend-setting game possible.

Table of Contents

Congratulations	1	Traveller's Recognition Guide	26
Your Ship	2	Planets	26
Finding Your Way Around the Sunracer Cockpit	3	Ships	26
The Viewscreen	3	Hazards of Astrogation	38
Engine Instrumentation	4	A Traveller's Guide to the Far Arm	41
Combat Instrumentation	4	Facts and Fallacies . . .	43
The Target Acquisition Computer (TAC)	6	Base Facilities	44
Maneuvering in Space	8	Other Things to do at Bases	46
Inertia	9	Playing Space Rogue	47
Docking with Bases	10		
Collisions	11		
Combat	12		
Damage	12		
Weapons	13		
Defenses	16		
Using the TAC in Combat	17		
Surviving Combat	19		
Navigating Within a Star System	21		
Travel Between Star Systems	24		

Congratulations!

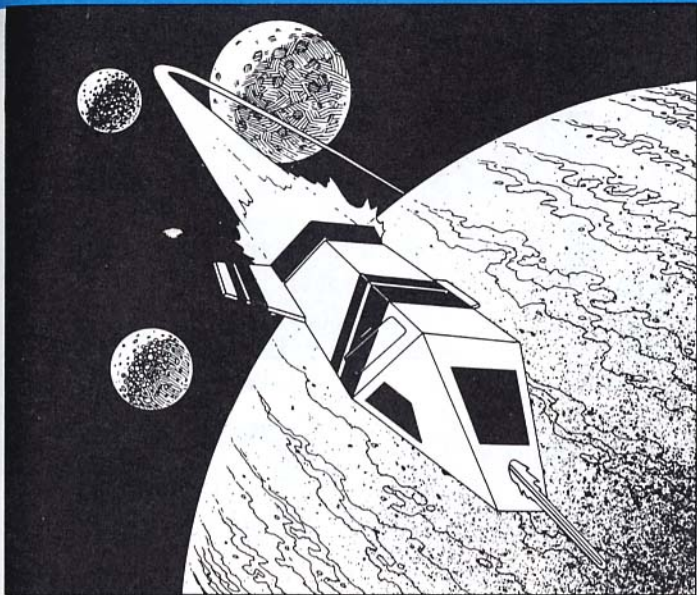

When you bought this MANDENWORKS ship, you made a fine purchase!

Your Sunracer scout ship embodies the research and manufacturing efforts of Mandenworks employees on 217 worlds throughout the Imperium. The Sunracer sets new standards for reliability, and can easily be customized to meet your specialized needs.

Sunracers travel the space lanes, their holds laden with manufactured goods for the outposts and vital raw materials for the settled homeworlds. Sunracers travel the ancient Malir gates, crossing light-years of deep space in a breath. Sunracers even explore the remote frontiers of the Far Arm!

but we don't last long unless we upgrade!

Won't you take a few moments to review this Owner's Guide for your new Sunracer?

Your Ship

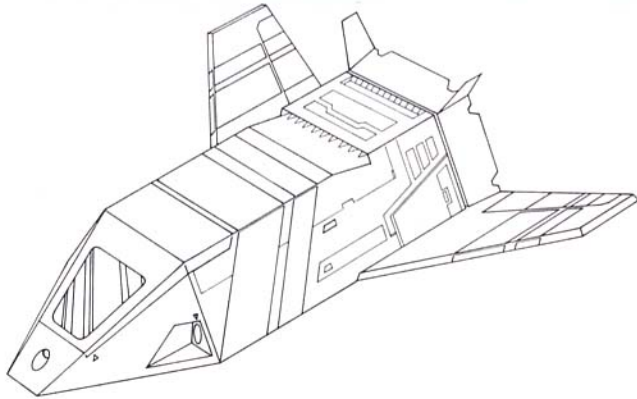

For nearly a decade the Mandenworks Sunracer-class model has been the Imperium's standard among the small, maneuverable ships of its class.

With an extensive selection of options, four tons of cargo capacity, and easy upgrade abilities, the Sunracer is the choice of scouts, couriers, families, joyriders, and anyone looking for a small ship and a price to match.

Class designation:	Sunracer (scout)
Length:	12 meters
Displacement:	14 tons
Armor:	300 units, upgradable (500 units maximum)
Beam:	Garnet laser (10 mw/ns), upgradable as option standard launch tube
Missile:	Forward-1, upgradable available as option
Shield(s):	Radionix cold fusion reactionless drive
ECM:	0.20 G-standard (turbo booster upgrade available)
Propulsion:	45
Acceleration:	4 (upgradable to 8)
Turn (°/sec):	
Cargo pods:	

*Including bureaucrats
in the Procurement Dept.
Sons of*

Finding Your Way Around The Sunracer Cockpit

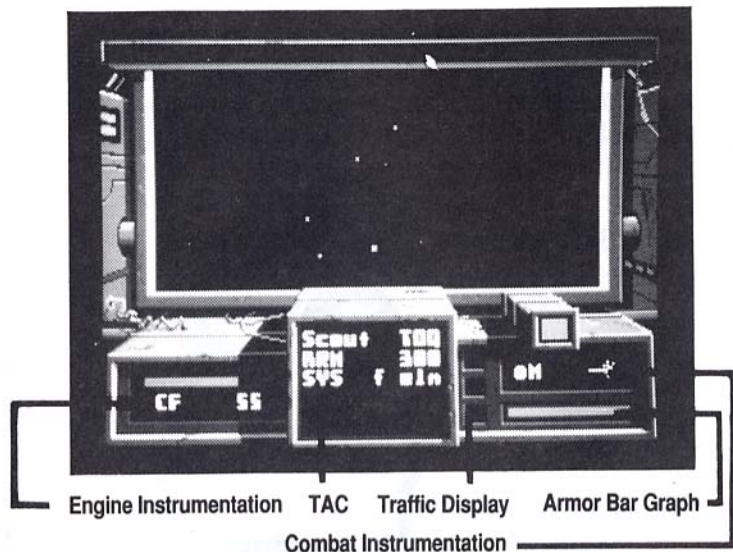

The Viewscreen

Seated in the cockpit you can see a 90-degree field of view showing the depths of space. Actually, this is your ship computer's simulation of the view outside. All the stars, bases, asteroids, antimatter shards, and drifting interstellar grit are created by the computer to represent real objects detected by the ship sensors.

With this simulation you can vary the view . . . quite an advantage over a mere porthole into space. Two alternate views are available.

Cinematic view shows your ship travelling through space just as you might see it in a sensotheater. Novice pilots understand their maneuvers better when they see the effects on movement "cinematically."

Chase view follows your ship at a distance, as though another ship were chasing you.

Engine Instrumentation

The left console contains engine instrumentation.

The bar graph shows your current speed; the longer the colored bar, the faster you are travelling. Beneath the bar graph is your speed in meters per second. A negative number means you are flying backward. The letters "CF" or "NF" indicate whether you are in Cruise Flight or Newtonian Flight mode; see below.

The number beneath the bar graph is your actual speed in Newtonian Flight mode. However, in Cruise Flight mode, it is your desired cruise setting. The bar graph shows your actual speed in either mode.

Combat Instrumentation

The right console contains combat instrumentation.

Ready Weapon

On top, one of four symbols indicates your ship's ready weapon and its status. The symbols represent your beam weapon and three kinds of missiles. Here are the weapon symbols:

Beam weapon



Plasma torpedo



SM-1



Nova missile



If your ship does not carry a given weapon, you will not see its symbol. Broken weapons have inverse symbols.

These weapons are described in the Combat section of this manual.

Armor Bar Graph - see diagram on page 3.

The bar graph beneath the weapon status field graphically shows how much ship armor remains intact. The longer the colored bar, the more armor you have left.

Traffic Display - see diagram on page 3.

The three-space traffic light display indicates the status of up to three other ships in your sector of space. Each lit light corresponds to an active ship in your sector. The color of the lights shows their status.

Green: *The ship is friendly. Friendly ships typically hail you when they pass, as a courtesy.*

Violet: *The ship is attacking another ship, not you. You may*

happen on a battle in progress, between a merchant and a pirate, for example.

Orange: *The ship is hostile to you and is attacking.*

Incoming Missile Warning Light

The incoming missile warning light above the right console lights up when an enemy is tracking your ship. You can dodge with an abrupt maneuver just before it hits.

The Target Acquisition Computer (TAC)

The TAC screen is located in the center console, below the main viewscreen. It displays data collected by your Target Acquisition Computer; a fifth generation system capable of discerning and tracking all targets in your sector. With its visual and data modes, you can locate and identify targets, get tactical readouts during combat, and coordinate weapon fire. You will find the TAC to be an indispensable tool for navigation and combat.

Selecting a Target

When you activate the TAC, it searches for any targets ships, bases, or Malir gates in your sector. If there is more than one target, the TAC will cycle from one target to the next with each key press.

To help pinpoint your target's location, the TAC superimposes a "heads up" cross hair on your main viewscreen. The cross hair appears as two pairs of arrowheads, which slide along the edges of the viewscreen. If your target is dead ahead, the arrowheads will be centered on the viewscreen edges, and

point inwards. As your target moves off to one side, the arrowheads will follow. If your target moves off the screen entirely, the arrowheads will flip to point outward, and continue to track.

Data Mode

In data mode, the TAC screen displays vital information on your target. Depending on the type of target selected, 2 to 5 lines of data are displayed.

If you are targeting another ship, the following 5 lines of data are displayed:

1st line - Class Name and ID beacon. The ship's official class type followed by a 3 letter/number unique ID beacon. Any messages transmitted by the ship will be preceded by this ID beacon. Warning: if this line is highlighted, this ship is attacking you!

2nd line - Range in Meters. The distance to the targeted ship in meters. Keep in mind that many ships have passive stealth devices that will render them invisible to the TAC beyond a range of about 10km. The TAC will lose its lock on out-of-

range ships and automatically disengage.

3rd line - Tactical Analysis. The AI module aboard your TAC continuously gathers telemetry data on your target. It then performs a sophisticated analysis on this data and determines the most likely tactic the ship is employing.

4th line - Armor Remaining. The amount of armor remaining on the ship. The hull will rupture when all the armor is destroyed, and the ship will perish.

5th line - Onboard Systems. Single letter abbreviations indicate which particular systems are installed onboard the ship. The six systems are: C - Countermeasures (ECM), F - Forward Shield, A - Aft Shield, E - Engine, B - Beam Weapon, M - Missile Launcher. A highlighted letter indicates that the system is damaged and non-functional.

If you are targeting a base or Malir gate, only the first two lines are displayed. If you have no selected target, the TAC gives you data on your Sunracer, with only the 1st, 4th, and 5th lines shown.

Visual Mode

In Visual Mode, the TAC screen shows a close-up view of your target. This can be useful for identifying targets, and for determining their orientation relative to yourself. If you have no selected target, the TAC screen shows your Sunracer.

Maneuvering in Space

Your scout ship has two steering systems. In the more primitive mode, Newtonian Flight (NF), your engines are fixed to thrust your ship straight ahead. As long as you increase thrust, your velocity increases in the current direction.

To change course, you must turn the ship and increase engine thrust as two separate actions. Turning your ship without adding thrust has no effect on your course. Newtonian Flight maneuvering is not recommended for novice pilots.

Your ship's standard mode, Cruise Flight (CF), links the engines to the steering system. When you turn, powerful electromagnets redirect engine thrust to aid in the turn.

In CF mode, thrust works as a cruise control. That is, you set the speed you desire, and the engines thrust until you reach that speed. When you change course, the engines thrust the ship in the new direction, trying to keep a steady speed.

Why wouldn't you always use Cruise Flight mode? Newtonian Flight is useful in strafing runs during combat, and in slingshot maneuvers around gravity wells -- stars, planets, and black holes.

To strafe, plot a fly-by course past your target in NF mode. As you pass, you can reorient the ship to keep the target in your viewscreen while still following the original fly-by course. In Cruise Flight mode, you would tend to ram your target instead.

To slingshot around a gravity well, accelerate to a rapid speed on a Newtonian fly-by course close to the well. The slingshot effect as you leave the well can amplify your velocity tremendously -- useful when you want to escape pursuit. (You can also put your ship into orbit around the well.) Cruise Flight mode during a slingshot can result in undesirable braking.

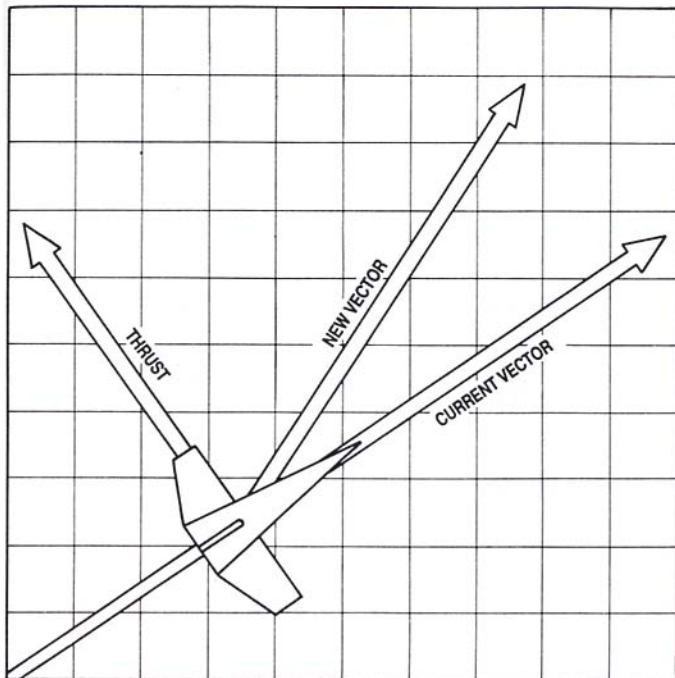

Inertia

In CF mode the illusion of smooth, inertialess flight can be very convincing, especially at low speeds.

However, Cruise Flight is subject to the same physical laws as Newtonian Flight. Foremost among these is inertia. The tendency to continue moving in a straight line affects every maneuver a pilot makes.

The faster you move, the higher your inertia. At high velocity, your ship's controls may feel sluggish and slow to respond. Gradual turns swing wide, and sharp turns become impossible. There is nothing wrong with the controls! You simply must overcome a greater amount of inertia to change your heading.

High-speed maneuvers are not recommended for novices. However, seasoned pilots develop a sense of inertia, and can actually use it to their advantage.

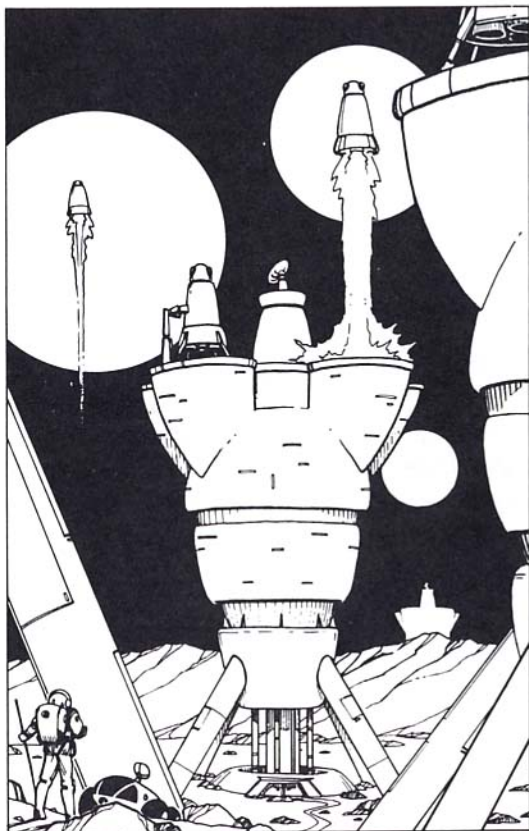

Docking With Bases

Your Sunracer is not equipped to land on planetary surfaces. Dock only in space, at one of the four recognized types of bases: starbases, outposts, mining stations, and carriers.

To dock your Sunracer at any base, simply "nudge" the base's docking platform with the nose of your ship. Automated docking equipment will take it from there. Be alert! Striking the wrong part of a base or docking at too high a speed may result in armor damage.

Here are the docking platforms for each kind of base.

Starbase:

The brightly lighted axial pillar that connects the two pyramidal halves.

Outpost:

The bright inner wall containing the black access door.

Mining station:

Nudge any part of a mining station to activate its docking equipment.

Carrier:

The main deck, marked by a landing stripe.

These four base types are described in the "Traveller's Recognition Guide" later in this manual.

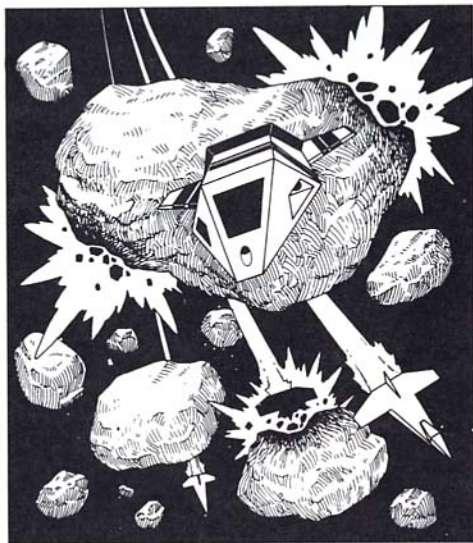

Collisions

Your Sunracer's armor and forward shield are designed to absorb some damage from collisions with solid objects. Remember, though, that the damage you incur from collisions varies as the square of your velocity.

In other words, if you hit an obstacle, your armor takes damage; if you hit the same obstacle going twice as fast (relative to it), you take four times as much damage as before!

Combat

Scouts must often venture into lawless areas. Your Sunracer is very capable of defending itself in unpleasant circumstances.

Always keep in mind that if your ship has more than one weapon system, you must choose one as your "ready weapon," using the ready weapon command. The dashboard ready weapon display symbolically shows which weapon is ready.

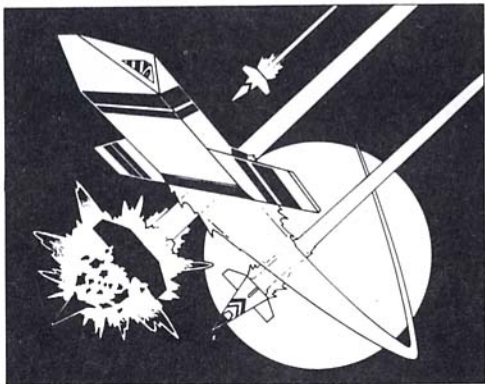

Damage

Damage from enemy fire is incurred to either your hull armor or to individual ship systems.

Damaged ship systems appear on your dashboard readout in inverse letters. If the engine is damaged, your ship reverts to backup thrusters, and your acceleration is cut to one-quarter normal. If any ship system is damaged, that system becomes non-functional.

Your current armor is shown on the dashboard readout and on the bar graph on the right console. If armor is reduced to zero, your ship is destroyed.

Weapons

Beam Weapons

Laser and particle beams are the standard weapons of ship combat. They strike instantly, penetrate force shields well, and ammunition is both free and unlimited.

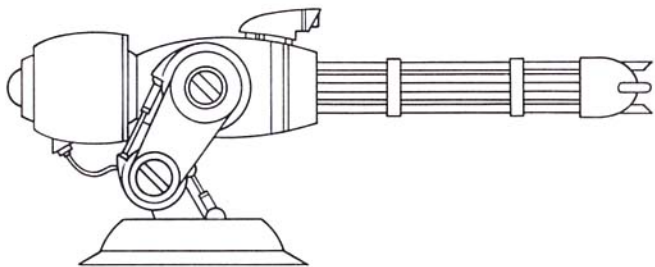

Lasers come in three varieties, designated "garnet" (10 megawatts/second output); "beryl" (15 mw/s); and "sapphire" (20 mw/s). Despite the names, these are not optically-pumped solid lasers but mode-locked gas dynamic models with opaque dye Q-switches. Your Sunracer sports a Taurietten garnet laser as standard equipment under full warranty.

Particle beams are CMG (coherent monopole-guided) beams of heavy W particles. Like sapphire lasers, they are rated for 20 mw/s damage. However, unlike lasers, particle beams cut through defensive force shields without any reduction in cutting power.

Recharging: *All beam weapons run on self-contained batteries that are recharged from the ship's power plant. If you fire before the battery has recharged completely, your shots are reduced in strength. A short time without firing allows the battery to recharge completely.*

Near the beam weapon symbol on your dashboard's ready weapon display is a circular indicator. Its size shows the current recharge status. The circle begins at full size; heavy fire reduces it to half size, and then one-quarter size. This shows that the beam weapon is firing at half or quarter power.

Missiles

Manual and automatic fire: Beside the recharge circle on the ready weapon display is a letter "M." This stands for "manual fire." You fire each shot manually.

Though not widely available in most areas, automatic lock-on and firing equipment changes the letter to "A" for "automatic fire." With this equipment you simply start the firing sequence, and the ship fires every two seconds. You can even change ready weapons and fire a missile while the beams continue firing.

Unlike beam weapons, missiles are expensive. Targets can jam their telemetry or dodge them. And once you fire one, it's gone. But nothing else matches their ability to inflict damage on the enemy.

Your ship includes one standard missile-launch tube with automatic reloading. It can hold a mix of up to 10 missiles or 20 plasma torpedoes. If the missile system is damaged, you cannot launch.

Reloading after a shot takes five seconds. When the tube is ready to fire again, the ready light glows green in the center of your dashboard's ready weapon display.

Check with Avenstar to see
if these have arrived yet.

Missiles accelerate at 2 G standard, and carry 30 seconds' worth of fuel. There are three types of missiles available for your Sunracer:

Plasma torpedoes, balls of superheated gas, inflict a rated equivalent of 75 megawatts of damage on a target. Plasma torps are cheap and compact, but they are not true missiles. Rather, they are dumb weapons without heat-seeking ability.

The **SM-1**, for "Standard Missile 1," inflict 100 mw of damage. These have heat-seeking ability, and target whatever enemy you have acquired with the TAC. See "Using the TAC in Combat," below.

Nova missiles, extremely deadly nuclear-tipped heat-seekers, inflict 250 mw of damage. Like the SM-1, the Nova zeroes in on whatever target you have selected with the TAC.

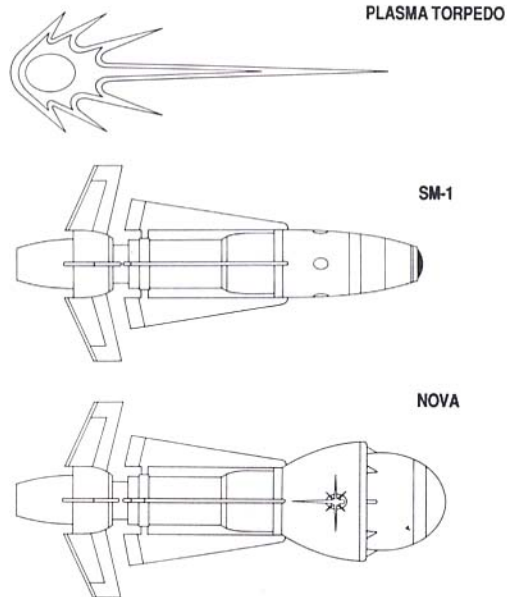

Defenses

Armor

Armor, standardized on all ships as sloped superconducting ceramic, spreads collision and energy damage equally throughout its structure. Therefore, each ship's armor is numerically rated in standard units of protection.

Armor is affixed in individual plates. The Sunracer comes with four plates (300 units) standard. Optional upgrades are available.

Force shields

Force shields reduce damage from collisions and, less effectively, from lasers. Originally designed to cope with navigation hazards such as asteroids, shields work best against collision with physical objects such as asteroids and missiles. Against lasers their effectiveness drops by one class. Against particle beams they have no effect.

Force shields are numerically rated according to their ability to reduce damage to your armor. Shield #1 stops 1/2 of incoming damage; #2 stops 3/4; and #3 stops 7/8 damage. Shields cover half of the spacecraft, and so are described as either "forward" or "aft."

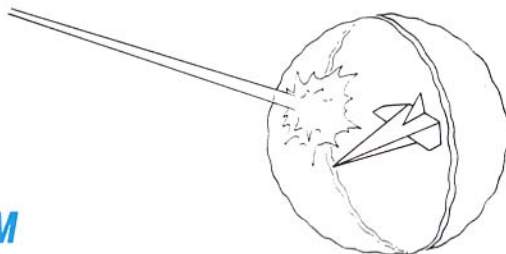

ECM

ECM (electronic countermeasures) uses X-ray cathode technology to jam the enemy's targeting devices. Put more directly, it interferes with the ability of heat-seeking missiles to target your ship.

ECM, rated by its percentage of effectiveness, is available in three levels: 25%, 50%, and 75%. The percentage indicates the ECM's chance to jam the missile and send it off on an erratic course. If the ECM fails, the missile targets you normally. Note that ECM does not reduce damage from hits.

Using the TAC in Combat

You'll find the Target Acquisition Computer a great ally when you enter combat. It not only provides vital data for making tactical decisions, but also coordinates the targeting and firing of your weapon systems.

Data Mode

In Data Mode the TAC displays several key pieces of information which can aid in your tactical decision making.

The Tactical Analysis (3rd line) provides an assessment of your target's intent. Extensive combat studies have proven the TAC to be 99.8% accurate, so don't hesitate to rely on its judgement. The TAC characterizes an enemy's intent as one of the following 10 tactics:

- Circle** - The enemy is circling around you trying to stay out of your arc of fire. Counter by circling behind the enemy.
- Close** - The enemy is making quick fly-bys designed to offer good, close shots. Fast ships often favor this tactic. Try to get your shots in just after the enemy passes.

- Cruise** - Your TAC displays this "tactic" for any ship not engaged in combat.
- Elude** - The enemy is accelerating and turning away from your field of fire. Plot an intercept course - try to head him off.
- Flee** - A running, zigzag course. The enemy has broken morale and is attempting to escape. You'll have to fly fast to catch him.
- Follow** - The enemy mimics your maneuvers. This tactic is only effective if the enemy gets behind you.
- Pursue** - The enemy is trying to catch you as quickly as possible. If you don't want to be pursued, don't try to run away.
- Ram** - Prepare for a collision!
- Stand** - The enemy stops and faces you. Big ships often do this just before they launch an attack.
- Swerve** - An erratic, high speed maneuver that is designed to avoid a collision or weapon fire. Don't waste missiles trying to hit a swerving ship. Just stay at a distance and keep him in your sights.

The Armor Remaining display (4th line) is a prime indicator of an enemy's battle worthiness. When this drops below zero, the hull ruptures, and the ship will perish. Most ships will try to flee when this nears zero. When you hit a ship with a missile or beam weapon, note how much damage it takes. This will give you a feel for the effectiveness of various weapons against shielded and unshielded targets.

The Onboard Systems display (5th line) reveals what functioning systems the enemy can bring to bear. Monitoring this display offers great tactical insight. For instance, if the enemy's engines are damaged, he won't be able to pull hard-G maneuvers; if his ECM or shields are damaged, he'll be vulnerable to missile attacks; if his weapons are damaged, you've pulled his teeth.

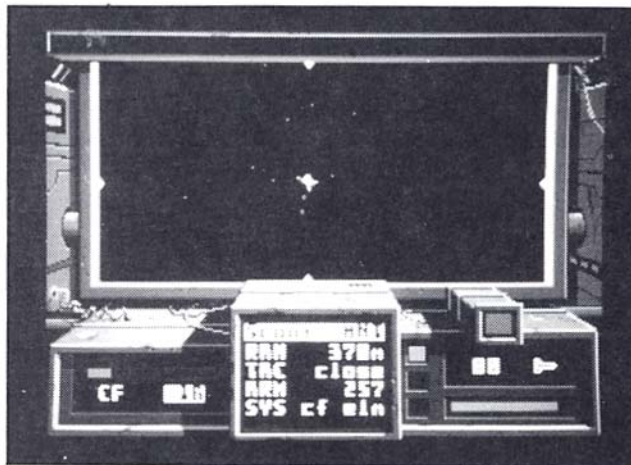

Weapon Fire Coordination

Your TAC coordinates weapons fire to hit your selected target. For smart missiles (SM-1 and NOVA), the TAC provides the heat signature of your target. For beam weapons, the TAC checks for a clear, line-of-sight path to your target. If the target lies out of the path, is too far away, or is blocked by another object, your TAC will stop the beam weapon from firing. This prevents needless discharging of the beam weapon's batteries (and embarrassing attacks on friendly ships that fly unexpectedly in your path).

Under certain conditions you may find it advantageous to disengage your TAC. For instance, if your target has powerful ECM, it will likely jam your smart missiles. However, if you launch a smart missile with your TAC disengaged, the missile will act as an unjammable, dumb missile. Aim well and it will always hit.

Surviving Combat

Do not pick fights recklessly! Not only can this incur severe damage, it also affects your reputation. Unlawful battle can bring police retribution and the attention of bounty hunters.

If you do enter combat, remember several points that are essential to your ship's safety.

Standing still is deadly. It simplifies your targeting, but unfortunately it also simplifies the enemy's. The veteran pilot keeps maneuvering at all times.

Some specific combat maneuvers that have proven useful include all the tactics the opponents use, as displayed on your TAC. In addition, you may create your own. For example, consider "overshooting." When an enemy is pursuing, reverse thrust rapidly. The opponent often flies on by, presenting a clear target profile.

If there is terrain in your sector, use it! You can hide behind asteroids; draw your enemy into collisions with antimatter shards; you can even slingshot around stars or planets to put on extra speed for escape or pursuit.



*Never known a Manchi
to accept surrender*

If your target has shields, try to knock them down with beam weapons. Then go in for the kill with missiles. Beam weapons can penetrate an opponent's shields more effectively, increasing your chance to knock out a critical system.

If the opponent proves too dangerous, try to escape. If you can get ten kilometers away from your enemy, his sensors will no longer be able to detect you, and he must break off pursuit.

You can improve your escape speed by jettisoning cargo. A full hold reduces your acceleration dramatically, so in desperate circumstances you can empty cargo bay contents into space and make a quick getaway.

As a last resort, you can try to surrender. After a standard radio call of surrender, pirate and merchant ships may plunder your cargo in return for your life. Imperial ships require you to pay off your bounty.

Navigating Within A Star System

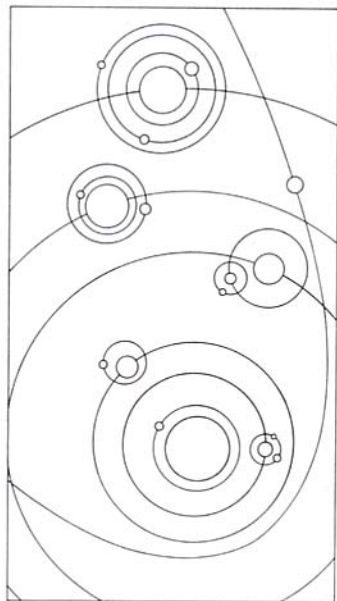

Navigation Control is the only way to travel the long distances between bases; to view the layout of star systems; and to review the status of your ship. Navigation Control also gives an overview of the system you occupy, shows the locations of the Malir gates used to travel between systems, and tells the date and time.

Unlike the cockpit viewscreen, Navigation Control does not show you a first-person view of your surroundings. The Navigation Control screen shows, at upper left, a part of the system you currently occupy, with your ship in the middle. Each system is subdivided into 1024 sectors in a 32x32 grid. Each sector is 1,000,000 kilometers on a side. Sectors are marked on the map with a grid of dots.

The map is not a simple record, but an electronic database that is constantly updated. As you journey across space, your ship moves to its new position on the map. Note how the system's planets move along their orbits with the passage of time.

When you encounter another ship in a sector, Navigation Control alerts you with a status message at the bottom of the panel. At upper right are the commands you can give, as follows:



Chart lets you chart a course anywhere in the system. When you select this command, brackets appear around the current sector. Using the keyboard or joystick, move the brackets to the destination sector. The computer lays in the course along the most direct route.

Helm is only available after you have charted a course. Select the Helm command to embark on the journey via autopilot. The Navigation Control screen shows the time at each stage of the journey. Press a key to stop the journey in the current sector.

If you come under attack in a sector, your journey will be halted automatically. You will only be able to resume your journey after you have resolved the battle.

In autopilot mode your Sunracer safely navigates the hazards of space -- asteroids, antimatter shards, and so on. Be aware, however, that your autopilot requires much more time to safely navigate these hazards (particularly if your engines are damaged). A straight course through hazards is not always the shortest one. For more about these hazards, see later sections.

Status shows your possessions; your reputation with the Imperium, pirates, and Manchi, based on monitoring of

radio traffic; and your ship's weaponry, armor, equipment, and state of repair.

Query retrieves data, when available, about a given sector: bases, significant hazards, even choice bits of lore or history. ~~You can also record your own sector notes using the Query function.~~

Scan lets you see other parts of the system. When you select this command, brackets appear around your current sector. Move the brackets around the map; new areas scroll onscreen. You can choose a sector and then Query for data about it.

Cockpit returns you to the viewscreen.

Broken!! No one can fix. Never
got to use it more than half a
dozen times! Thank you Mandenworks!

Travel Between Star Systems

Warp drive has yet to be invented. All spacecraft must travel at sub-light speeds. Therefore, crossing the empty gulfs between systems would take months or years.

How fortunate then, that the ancient Malir gates link Imperial systems through wormholes. Each pair of gates connects two star systems. Your Navigation Control database shows each system's Malir gate(s).

Your Sunracer has been approved by Imperial authorities for travel through all known interstellar Malir gates. When using one of these teleportation devices, keep several safety tips in mind.

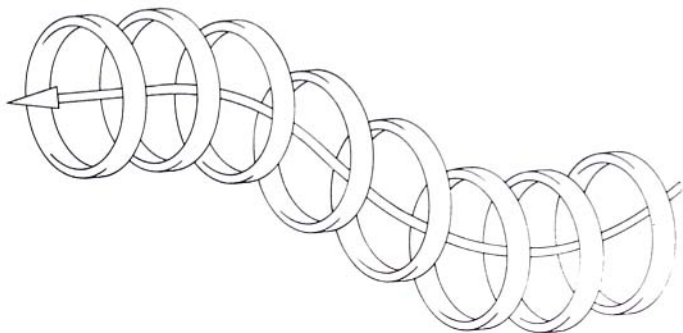

*Heard rumors
of breakthroughs here*



1. Known sentient beings that can use the Malir gates without harmful effects include humans, Baakili, Sishaz-ahng, doven, Braunigala, and ssathlar. When some other sentient races, such as the Manchi, use the gates, they invariably die.

2. The gates are long, hollow cylinders. Pilot your ship down the center of the cylinder toward the glowing end. You must achieve a minimum speed of 21 m/sec to activate the gate's wormhole effect.

3. Once within the wormhole, remain within the glowing rings. When you reach the end of the wormhole, you will be dropped back into normal space by the Malir gate at the destination system. Should you stray outside the wormhole before you reach your goal, the jump is faulty and you reappear at the gate of origin.

4. Move through the wormhole as quickly as possible. Corrosive gases within the hole damage all known classes of hull armor.

Imperial researchers have devised the null damper to counteract this effect. However, for tariff reasons null dampers are not available in some parts of known space. Check with your ~~Mandenworks~~ dealer for more information.

the black market.

Traveller's Recognition Guide

Mandenworks offers this handy guide to the objects you may encounter in space. Each entry shows the screen symbol that represents the object in your viewscreen simulation or Navigation Control system maps.

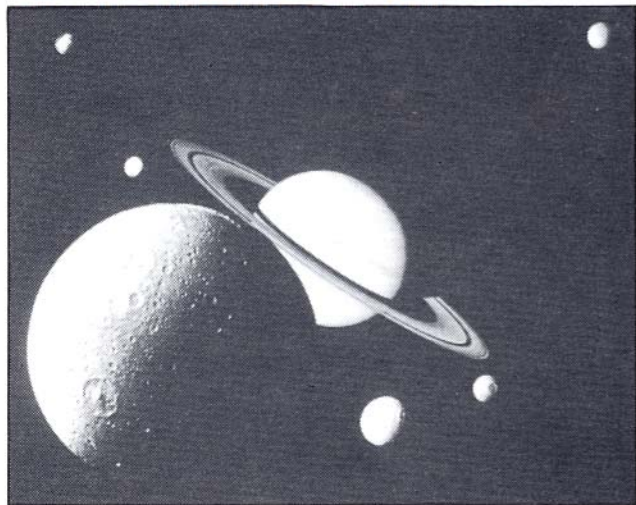

Planets

There are three principal types of planets you may encounter. Warning: Do not try to pilot your Sunracer into a planetary atmosphere. The ship is not equipped for planetary exploration, and will burn up due to air resistance and the heat of friction.

Ships

As space travel increases in popularity, the traveller encounters more vehicles every day. For your safety and convenience, this section describes some of the most widespread types of ships.

Abbreviations used: m = meter; t = ton; mw/s = megawatts per second; Fwd = forward; °/sec = degrees per second; g = gravities (standard units of acceleration).

TITAN

Type:	<i>Imperial</i>
Class designation:	<i>Heavy cruiser</i>
Predominant color:	<i>Green</i>
Length:	<i>95 m</i>
Displacement:	<i>2,232 t</i>
Armor:	<i>1,000</i>
Beam:	<i>particle (20 mw/s), turreted.</i>
Missile:	<i>Nova</i>
Shield(s):	<i>Fwd-3, Aft-3</i>
ECM:	<i>50%</i>
Propulsion:	<i>Imp. Shipyards positron drive</i>
Acceleration:	<i>0.15 g</i>
Turn (°/sec):	<i>10</i>

The glory of the Imperial fleet, the Titan-class cruiser reduces piracy in a system by its mere presence. Titans lack nothing in state-of-the-art armaments and defenses.

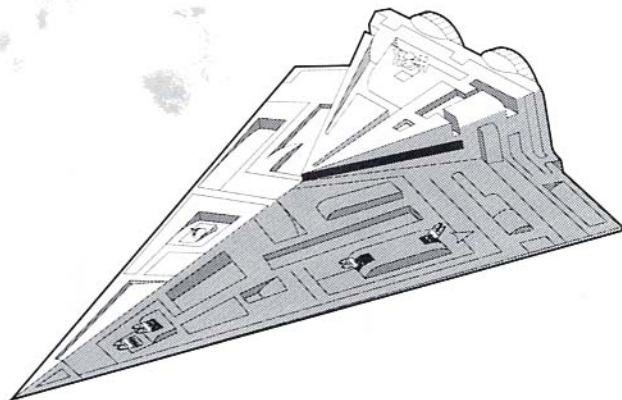

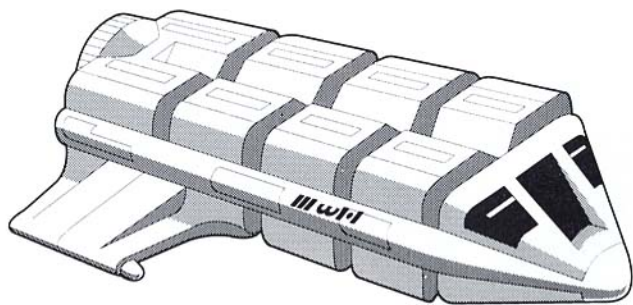

TANKER

Type:	Merchant
Class designation:	Trader (50 t capacity)
Predominant color:	Blue
Length:	45 m
Displacement:	371 t
Armor:	360
Beam:	Beryl laser (15 mw/s), turreted
Missile:	SM-1
Shield(s):	Fwd-1, Aft-2
ECM:	20%
Propulsion:	Varies
Acceleration:	0.20 g
Turn (°/sec):	15

The vehicle of choice for the prosperous trader, this sturdy model emphasizes cargo capacity but does not neglect defense. Though not flashy, a Tanker fusing skillful defense tactics can often send a more maneuverable Dart packing.

CRUISER

Type:	Imperial
Class designation:	Light cruiser
Predominant color:	Green
Length:	50 m
Displacement:	478 t
Armor:	435
Beam:	sapphire laser (20 mw/s), turreted
Missile:	SM-1
Shield(s):	Fwd-3, Aft-2
ECM:	30%
Propulsion:	5 Radionix MEGA reactors
Acceleration:	0.30 g
Turn (°/sec):	25

Whereas Titans patrol the lawless frontiers of space, Imperial cruisers customarily anchor support fleets in settled systems. However, heavy pirate activity can draw cruisers into deep space. They are a match for any pirate vessel.

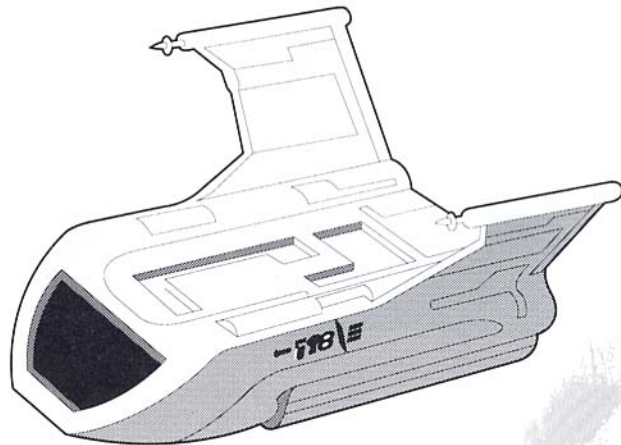

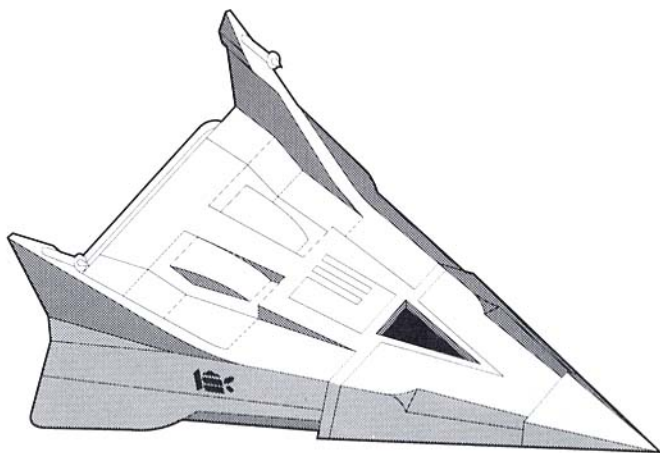

CORSAIR

Type:	Pirate
Class designation:	Light cruiser
Predominant color:	Orange
Length:	48 m
Displacement:	434 t
Armor:	405
Beam:	Beryl laser (15 mw/s), turreted
Missile:	SM-1
Shield(s):	Fwd-2, Aft-2
ECM:	25%
Propulsion:	5 Radionix MEGA reactors;
Acceleration:	0.30 g
Turn (°/sec):	30

Still extremely dangerous after more than two decades of service, the Corsair model remains popular along the frontier and in lawless areas. Facing a hostile Corsair, your best tactic is to surrender your cargo and hope the pilot is in a friendly mood.

SCOW

Type:	Merchant
Class designation:	Trader (10 t capacity)
Predominant color:	Blue
Length:	23 m
Displacement:	74 t
Armor:	210
Beam:	Garnet laser (10 mw/s), turreted
Shield(s):	Aft-1
ECM:	--
Propulsion:	Varies widely
Acceleration:	0.25g (varies)
Turn (°/sec):	20

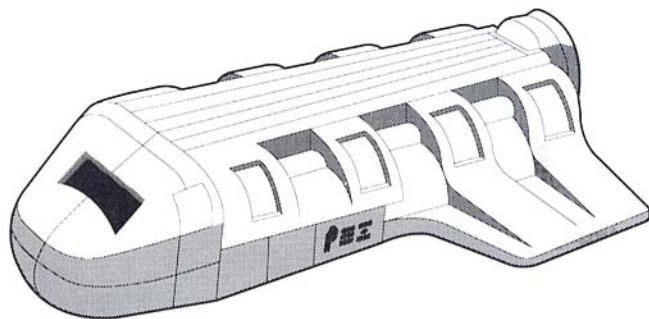

More of these dependable workers travel the spaceways than any other ship type. Scows place cargo capacity above all else.

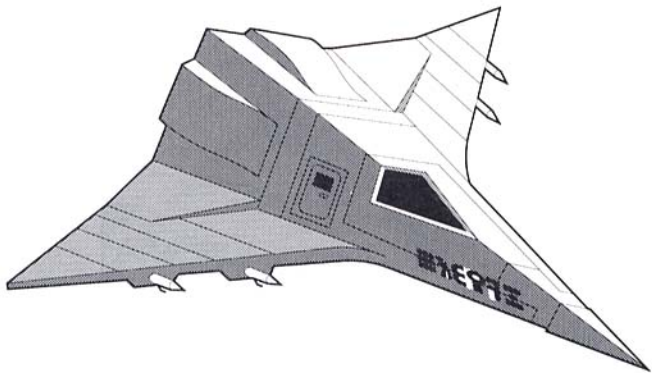

DART

Type:	Pirate
Class designation:	Fighter
Predominant color:	Orange
Length:	12 m
Displacement:	16 t
Armor:	245
Beam:	Garnet laser (10 mw/s)
Missile:	SM-1
Shield(s):	Fwd-2
ECM:	10%
Propulsion:	Borelle High Performance
Acceleration:	0.30 g
Turn (°/sec):	45

A ship for pirates on a budget -- no interior comforts, but it sports a highly-tuned engine and astounding maneuverability. In combat with a Dart, fly an erratic course and try to wear down its armor.

HUNTER

Type:	<i>Independent</i>
Class designation:	<i>Fighter</i>
Predominant color:	<i>Green</i>
Length:	<i>21m</i>
Displacement:	<i>90t</i>
Armor:	<i>350</i>
Beam:	<i>Particle (20 mw/s)</i>
Missile:	<i>Sm-1</i>
Shield:	<i>Fwd-3</i>
Propulsion:	<i>3 Radionix MEGA reactors</i>
Acceleration:	<i>0.31 g</i>
Turn (s/sec):	<i>40</i>

With their particle beams and Fwd-3 shields, Hunters are efficient killers. A favorite of bounty hunters, they are often found prowling the lawless regions for prey.

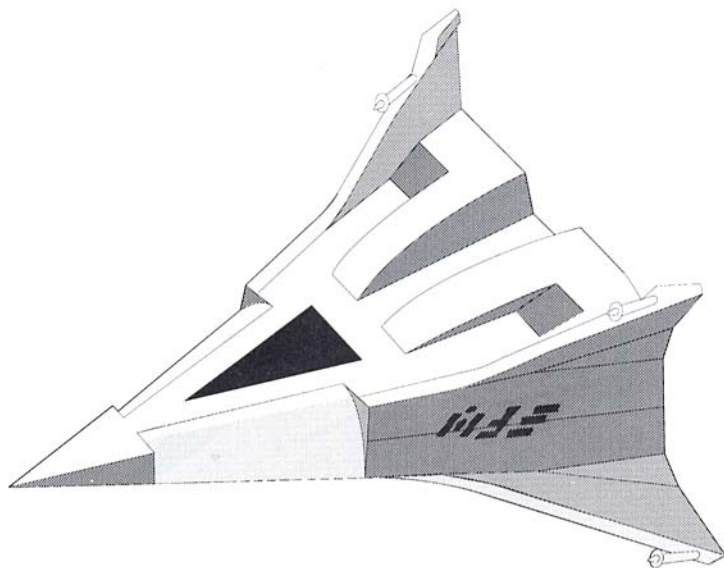

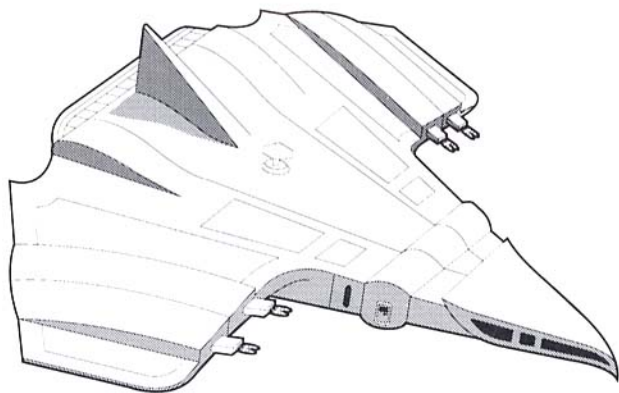

Not all ships you meet belong to the Imperium. The hostile aliens called the Manchi pilot ships of bizarre design. By request of the Imperial admiralty, Mandenworks offers what is known about these aliens' principal ship types.

VULTURE

Type:	Manchi
Class designation:	Light cruiser
Predominant color:	Violet
Length:	49 m (est.)
Displacement:	456 t (est.)
Armor:	480 (est.)
Beam:	sapphire laser (20 mw/s)
Missile:	Plasma torpedo
Shield(s):	Fwd-2, Aft-1 (est.)
ECM:	--
Propulsion:	Unknown
Acceleration:	0.30 g
Turn (°/sec):	25

In every encounter with Imperial ships, Manchi Vultures have attacked to kill, given no quarter, and have never accepted surrender. Exercise extreme caution.

WASP

Type:	<i>Manchi</i>
Class designation:	<i>Fighter</i>
Predominant color:	<i>Violet</i>
Length:	<i>11 m</i>
Displacement:	<i>13 t</i>
Armor:	<i>180 (est.)</i>
Beam:	<i>Beryl laser (15 mw/s)</i>
Missile:	<i>Plasma torpedo</i>
Shield(s):	<i>--</i>
ECM:	<i>--</i>
Propulsion:	<i>Unknown</i>
Acceleration:	<i>0.45 g</i>
Turn (°/sec):	<i>50</i>

These incredibly fast and maneuverable fighters appear to double as scouts, for they are often found deep inside Imperial space without evident support craft. Pilots often display suicidal attack tactics.

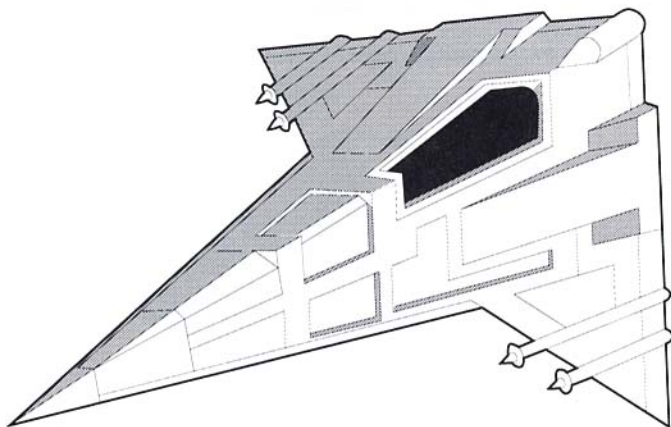

Bases

The life's blood of all star travellers, bases provide protection, repair facilities, trading posts, and a friendly cantina. Only at bases can you meet people, get your ship repaired, or purchase new equipment and cargo.

There are four principal types of bases:

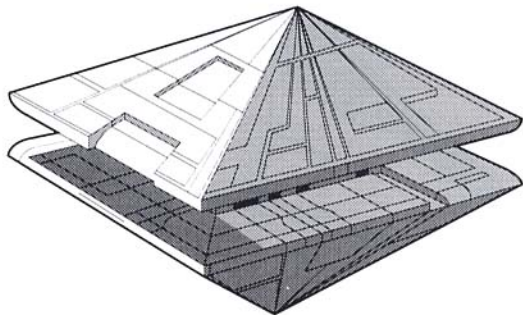

Starbases are the Imperium's grandest achievements, full cities in space that can supply all of a traveller's needs. Each starbase is the work of generations, and each draws the finest pilots and most desirable trade goods in known space.

Unlike other bases, Imperial starbases routinely check incoming ships for contraband cargo. Any contraband discovered is immediately confiscated.

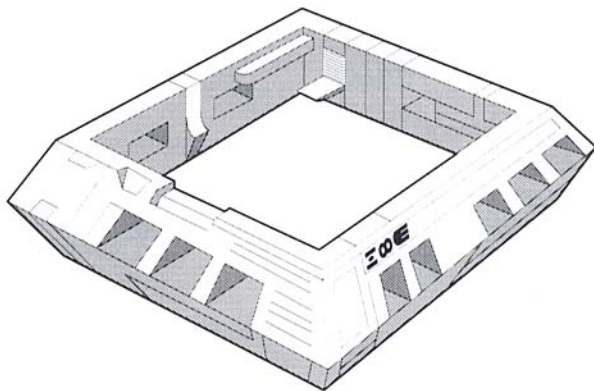

Outposts are centers of commerce for systems that have not yet constructed a starbase. They offer no-frills service for the traveller's immediate needs.

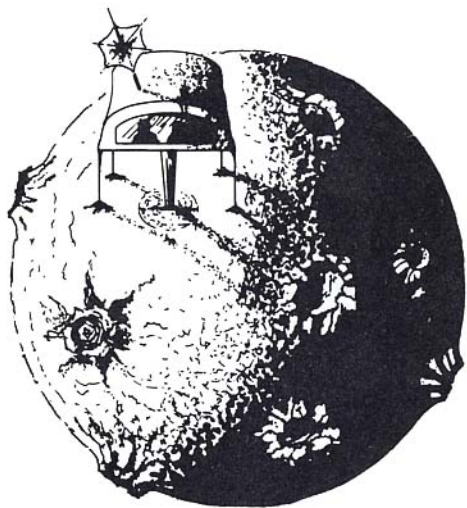

Mining stations -- solitary frontier depots -- pioneer new sections of space and supply civilization with vital raw materials. Many mineral-rich planetoids host these rugged commercial stations. They are usually operated by gigantic megacorporations such as MiCon or ConVec.

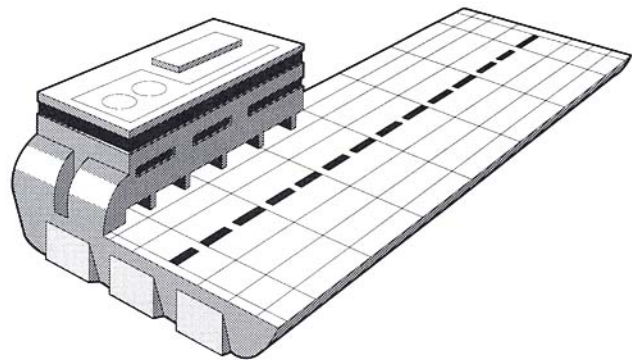

The new *Imperial carrier* serves as a platform for an entire squadron of the Imperial fleet. It provides police protection and asserts civilized authority in lawless areas. Private ships may dock at carriers for security, supplies, and repairs.

The first of these amazing new bases, the Koth, is named for the heroic admiral who led the Imperium to victory in the Battle of Binary Stars. It is stationed in the Arcturus system in the Far Arm. Other carriers are under construction.

Hazards of Astrogation

The pilot can encounter many hazards in the wilds of deep space. Some, such as pirates, can be fought. Others are natural and can only be avoided. Natural hazards are summarized below.



Antimatter shard fields form deadly obstacles. Antimatter atoms carry electric charges opposite to those of conventional matter. When matter and antimatter meet, the charges cancel out explosively, destroying both.

Conventional force shields provide little protection against antimatter shards. The only safe tactic is to avoid them through slow and painstaking piloting.

Asteroids are small boulders or ice chunks. Your ship's shield provides effective protection against collision with an asteroid, so long as you travel slowly.

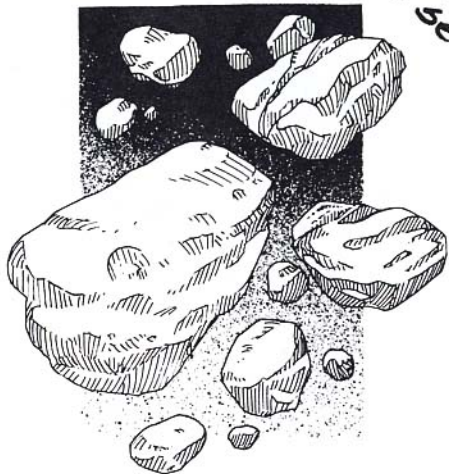

Watch for
uncharted hole
in sector m

Black holes are the invisible remnants of massive stars. A black hole's gravity is so strong that no ship -- in fact, not even light -- can escape its fatal pull. Known black holes are noted in your ship's database. However, theorists believe there may be many more uncharted black holes, so beware.

Ion storms, dangerous clouds of charged particles, form from whorls in turbulent stellar winds. Traders sometimes report spoilage of cargo due to ionization.

Nebulae are clouds of interstellar gas and dust. They slow ship passage and therefore increase travel time. Some nebulae gases are corrosive, and can eat away at your ship's hull armor.

Should your destination lie within a hazard field, consider travelling elsewhere for a time. Some destinations, such as planets, may orbit out of the field with the passage of time.

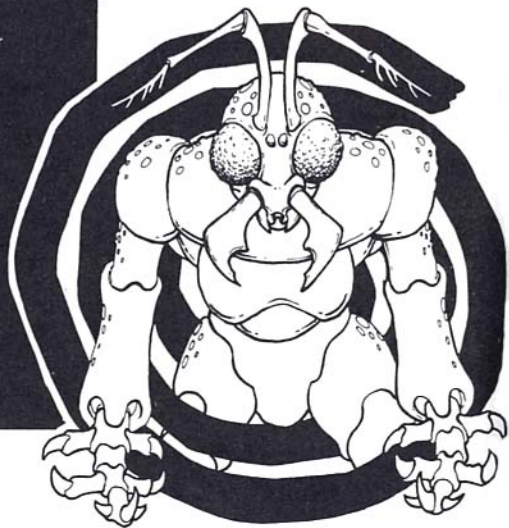

A TRAVELLER'S GUIDE TO THE FAR ARM

THANK YOU for purchasing this spacecraft at a Far Arm dealership! Merchants of the Far Arm count on your support to push back our expanding frontier. And in return, you can count on the same top-quality service and attention to detail offered in the busiest sectors of the Imperial Arm.

*plus pirates, Manchi raids,
uncharted black holes,
no extra charge.*

*In the 2300-year history of the Imperium, the Far Arm is a newcomer to the galactic stage. Our small but durable net of Malir gates was discovered hardly a century ago. As late as 2217 the exploration ship *Leading Edge* crashed in an ion storm in the Sigure system, its fate unknown until a generation later.*

Though colonization proceeded over the next century, the sleepy Far Arm attracted little attention until the ill-advised Rebellion, an abortive uprising by seedy frontiersmen in the Gryphon system.

The Imperium crushed these scoundrels at the famed Battle of Binary Stars in 2303. For his heroism in this battle, Imperial Admiral Koth received the Golden Sunburst of Valor, the only living person so honored.

The Far Arm's path to Imperial acceptance began when Emperor Hiathra assigned our Deneb System to Duchess Avenstar. No one could have envied the young Duchess her task of cleaning up the rowdiest system in the Galaxy. But to the critics' surprise, Avenstar has turned Deneb into one of the shining spots of the Far Arm, a safe harbor and prosperous home for any citizen.

Today the Far Arm is home to a dozen thriving bases in eight systems. The Far Arm is represented in the 100-member Ruling Council on the Imperial homeworld. Multi-system corporations like MiCon and ConVec co-exist peacefully with independent operators on Ross, Lagrange, and Trochal. All supply the raw materials that make possible YOUR standard of living!

While you travel the Far Arm, be sure to stop and visit these exciting systems, all conveniently connected to the reliable network of Malir gates:

Karonus: Site of magnificent Hiathra Starbase and the historic MiCon I mining station. Piracy has been virtually wiped out in this sector.

Deneb: Impressive Denebprime Starbase is the home of Duchess Avenstar. Piracy has been much reduced under her wise rule.

Gryphon: ConVec East mining station welcomes all miners, mineralogists, and tourists. See the deep-space monument commemorating the Battle of Binary Stars.

Arcturus: MiCon II mining station awaits the visitor with a taste for industrial technology. At this writing, Arcturus hosts the Imperium's fabulous carrier Koth, newest addition to the fleet and a shining symbol of the rule of law in the Far Arm.

Nar'see: Lagrange mining colony produces the finest titanium in the galaxy. Nar'see's fields of antimatter shards have attracted much attention in popular entertainment; but space is a big place, so they're easy to avoid!

Bassruti: The Free Guild Independent Outpost experiments with new social attitudes toward taxation and authority. Meanwhile, the advanced Bassruti Genetics Research Center is making exciting new discoveries about the nature of life.

Signature: Trochal Independent Outpost stalwartly holds down the frontier against Manchi incursions. Piracy is no longer a significant problem.

Zed: The MiCon IV outpost is proud to announce that the distinguished gravitation physicist Zoriah Prosk is pursuing further research breakthroughs in its laboratories. Another sign that the Far Arm is attracting the movers and shakers of the Imperium!

FACTS AND FALLACIES ABOUT THE FAR ARM

Our home has attracted attention throughout the Imperium, both in action-adventure entertainment and, sadly, in the news of the MiCon III tragedy. As you visit the Far Arm, take this opportunity to get the facts!

1. The Imperial government extends across the Far Arm. As governing body, defense force, and police power, the Imperium retains authority in all systems. So-called "lawless areas" are fiction. Of course, any traveller in deep space takes certain risks. But deep space can be risky in the Imperial Arm itself!

The Imperial bounty system instituted by Duchess Avenstar has produced a significant reduction in crime. By this system, a lawbreaker incurs a bounty for each misdeed. This gives incentive for the Far Arm's clever and well-armed bounty hunters to pursue and punish the wrongdoer.

A criminal can also visit any Imperial starbase and

pay off his bounty, which (after processing fees are deducted) goes into a restitution fund for victims.

2. The Scarlet Brotherhood are not pirates. This guild of free traders believes in the conduct of trade without onerous government restraints. Past incidents of sub-standard behavior no longer represent the Brotherhood's methods. Piracy has decreased every year since the failed rebellion of 2303.

3. There is no "Black Hand." We enjoy the action stories about this supposed cult of "psychic assassins" as much as the next sentient being. But believe us, no one in the Far Arm can kill you at a touch, hypnotize you at a distance, or drive you crazy by looking at you. We can all rest more easily for that!

4. The Manchi threat is under control. The Far Arm's proximity to Manchi space should not worry tourists. No Malir gate connects their territories to ours, so Manchi ships can reach only the most distant worlds, and only in small numbers. Imperial police are well able to protect citizens from these mindless insects.

Do not let Manchi hostility color your attitudes

So is believing everything you read

not so I've noticed

right!

toward the many other valued and trusted sentient races found throughout the Far Arm. By and large these nonhuman races engage in honest trade, in material goods and, in the case of the Baakili Far Traders, information. Treat them well and they treat you the same way.

BASE FACILITIES

Because travellers speak different languages or perceive in different bands of the spectrum, bases use a uniform code of symbols to designate facilities.

Repair



A wrench indicates a repair station. Move up to the counter, in front of the friendly staffer on duty, and ask about repairs or supplies.

If you ask for supplies, the staffer gives a price list of your ship automatically while you are on base.

If you ask for repairs to your armor or ship systems, the staffer provides a speedy cost estimate according to how much damage you would like repaired. If you pay the fee, the repairs will be performed automatically while you are on base. Remember: It's always cheaper to repair than to replace!

Trade



A "\$" symbol (family crest of the legendary trader Igon Stowellon, whose exploits spawned much folklore) indicates a trading post. The easiest and most widespread method of income in the Far Arm, trade offers beginning spacefarers the opportunity to visit many systems and serve the Far Arm community.

Move up to the counter in front of the friendly trader and ask to buy or sell merchandise.

If you ask to buy, the trader gives you a manifest of cargo available for purchase. All goods are sold in convenient one-ton shipping containers. For raw materials like minerals or agriproducts, the weight is simple bulk; for high technology items or luxury goods, much of the weight is taken by frameworks, padding, and shield generators to prevent damage in transit.

If you ask to sell, the trader makes an offer on the cargo in each of your holds.

Outfitting



Look for the rocket symbol to find an outfitter, a dependable supplier of weapon and defense systems, engine upgrades, and a wide selection of equipment for that special need. Whether you want an armor upgrade, a spare cargo pod or a turbo thruster, just go up and ask your friendly Far Arm merchant. And remember, installation is free!

Cantina

In these convivial taverns and eateries, travellers from every sector of space converge for good fellowship and conversation. You might run into anyone from an Imperial captain to a Baakili Far Trader.



OTHER THINGS TO DO AT BASES

On bases, you can talk to anyone. When you respond to a remark, the responses you can make appear at the bottom of the screen. Select the one you want. The conversation continues based on that selection, and it may offer you further responses.

You can examine or take items, or even pick the locks on locked doors or safes. (The Far Arm Amalgamated Chambers of Commerce do not endorse theft or illegal entry; this is mentioned for informational purposes only.)

You can get a list of your current possessions, the condition of your ship, and your reputation with various factions in the Far Arm.

To leave a base, move next to your ship's hatch and enter. Your ship leaves the base automatically. You're ready to head elsewhere in the exciting, enchanting Far Arm!

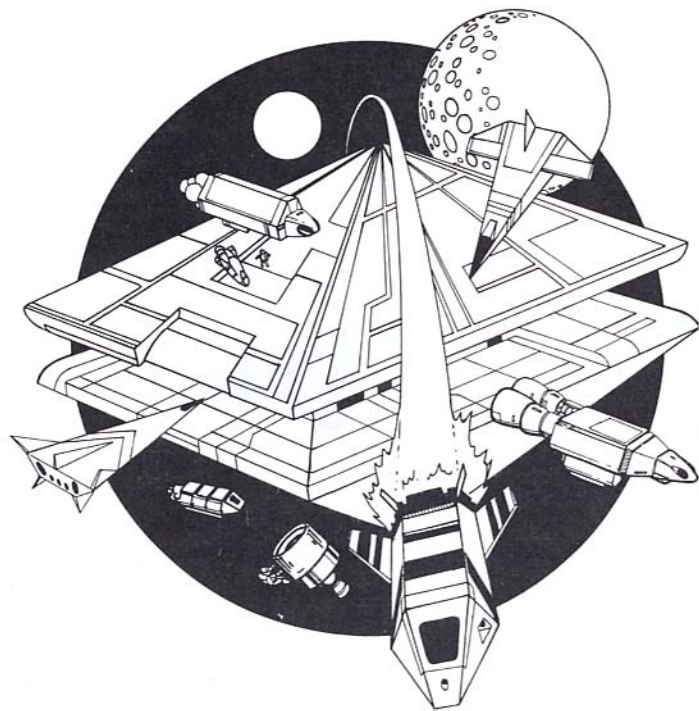

Playing Space Rogue

WHAT YOU DO IN THIS GAME

Space Rogue is not just a spaceflight combat simulator it's a role playing game.

In the role of a space pilot you do lots of different things besides fly your ship. You must pursue a career to generate income, so you can undertake long-range goals beyond your immediate mission.

Talk to everyone you meet. Some will offer you missions. Many have information you need to survive.

You have a reputation in the Far Arm, and what you do in the game affects it. For example, if you come across a space combat between a merchant and a pirate, you can get involved on one side or the other, and that affects your reputation with both merchants and pirates.

Your personnel status screen shows your standings with the Imperium, the Merchant Guild, and the pirates. These stand-

ings directly reflect your dealings with these organizations and affect your ability to travel peacefully in space, to gain the aid of others, and therefore to achieve your goals in the game.

Repute is your reputation as a combat pilot. Each victory in combat increases your repute; however, as your repute grows, it takes progressively more (and more spectacular) kills to further increase your repute. Repute also governs the likelihood that an opponent will break morale and flee from combat.

WHAT DIRECTION TO TAKE

As the game begins, you have no clear goal. But the Far Arm offers many career opportunities. You can pursue any or all of the following activities.

Trading. *This is the easiest way to make money and the best way to get started in the game. Luxury and high-tech goods are cheap at Karonus, whereas raw materials are expensive. In*

the distant systems, just the opposite is true. You can exploit the differences to make credits. See what cargo is available.

Be wary of combining radically different kinds of cargo, as some types have unusual effects on others. Some kinds of cargo are also perishable; make sure you sell them quickly.

Piracy. *Raiding merchant ships is lucrative, and they usually surrender rather than fight to the death. However, piracy brings a bounty on your head, and the bounty hunters will descend in force unless you pay off the bounty at a starbase. You need a fast, well-equipped ship for this roguish life.*

Bounty hunting. *Search for and destroy pirate ships to collect Imperial bounties. This is profitable but extremely dangerous. Only the best-equipped ships try bounty hunting.*

If you pursue these activities, explore known space, and talk to everyone you meet, you will eventually find a clear goal. You can achieve that goal while following any career. But your methods will vary according to whether you are a trader, pirate, or bounty hunter.

Good luck!



Credits

Game Design

Paul Neurath

Producer

Dallas Snell

Associate Producer

Alan Gardner

Programming

*Paul Neurath, Steve Muchow
Ned Lerner, John Miles*

Additional material

Warren Spector, Allen Varney

Computer Graphics

*Keith Berdak, Jeff Dee,
Denis Loubet*

Product Packaging

*Lori Ogwulu, Cheryl Neeld,
Sabrena Allen*

Photography

Ray Studios

Playbook

Allen Varney

Playbook Art

Studio X

Playtesting

*John Aslin, Chris Whiteside,
Kirk Hutcheon, Jonathan Lamy,
Dan Coughlin, Steve Cantrell,
John Watson, Jon Nials,
Joel Manners, Paul Malone*

WARRANTY

ORIGIN SYSTEMS, Inc. LIMITED 90 DAY WARRANTY. ORIGIN warrants to the original purchaser of this computer software product that the recording medium on which the software programs are recorded will be free from defects in material and workmanship for 90 days from the date of purchase.

If the recording medium is found defective within 90 days of original purchase, Origin agrees to replace, free of charge, any such product upon receipt at its Factory Service Center of the product, postage paid, with proof of date of purchase. This warranty is limited to the recording medium containing the software program originally provided by Origin. This warranty shall not be applicable and shall be void if the defect has arisen through abuse, mistreatment or neglect. Any implied warranties applicable to this product are limited to the 90-day period described above. If failure of the software product, in the judgment of Origin, resulted from accident, abuse, mistreatment or neglect, or if the recording medium should fail after the original 90-day warranty period has expired, you may return the software program to Origin, at the address noted below with a check or money order for \$5.00 (U.S. currency), which includes postage and handling, and Origin will mail a replacement to you. To receive a replacement, you should enclose the defective medium (including the original product label) in protective packaging accompanied by: (1) a \$5.00 check (2) a brief statement describing the defect, and (3) your return address.

EXCEPT AS SET FORTH ABOVE, THIS WARRANTY IS IN LIEU OF ALL OTHER WARRANTIES, WHETHER ORAL OR WRITTEN, EXPRESS OR IMPLIED, INCLUDING ANY WARRANTY OF MERCHANTABILITY OF FITNESS FOR A PARTICULAR PURPOSE, AND NO OTHER REPRESENTATION OF CLAIMS OF ANY NATURE SHALL BE BINDING ON OR OBLIGATE ORIGIN. IN NO EVENT WILL ORIGIN BE LIABLE FOR SPECIAL, INCIDENTAL OR CONSEQUENTIAL DAMAGE RESULTING FROM POSSESSION, USE OR MALFUNCTION OF THIS PRODUCT, INCLUDING DAMAGE TO PROPERTY AND TO THE EXTENT PERMITTED BY LAW, DAMAGES FOR PERSONAL INJURY, EVEN IF ORIGIN HAS BEEN ADVISED OF THE POSSIBILITY FOR SUCH DAMAGES. SOME STATES DO NOT ALLOW LIMITATIONS ON HOW LONG AN IMPLIED WARRANTY LASTS AND/OR THE EXCLUSION OR LIMITATION OF INCIDENTAL OR CONSEQUENTIAL DAMAGES, SO THE ABOVE LIMITATION AND/OR EXCLUSION OR LIMITATION OF LIABILITY MAY NOT APPLY TO YOU. THIS WARRANTY GIVES YOU SPECIFIC LEGAL RIGHTS. YOU MAY HAVE OTHER RIGHTS WHICH VARY FROM STATE TO STATE.



P.O. Box 161750 • Austin, Texas 78716

About the Author . . .



Paul Neurath

"I've always been fascinated by space exploration," begins Paul Neurath in a recent interview. "The Apollo missions, the planetary probes, the shuttle launches - these momentous achievements made science fiction a fact."

Paul has captured this fascination with space into a career as

a game designer. His first published work, entitled *Deep Space*, put you in the cockpit of a futuristic spacecraft, battling hordes of nasties. His latest release explores this theme more deeply. "*Deep Space* was fun," continues Paul, "but I wanted to design a game that would really immerse you in a futuristic, starfaring universe. One with its own geography, history, and cast of characters. So I wrote *Space Rogue*."

Prior to embarking on his career in game design, Paul attended Wesleyan University, studying Astrophysics and Environmental Science. When he isn't cooped up inside with his computer, he enjoys backpacking, camping, and white-water canoeing. He resides in New Hampshire with his wife, Karen, and two year old daughter, Rachel.

SPACE ROGUE
Proof of
Purchase



P.O. Box 161750, Austin, Texas 78716