

MPs MicroProse Software

# Decision in the Desert



**“YOU are in Command —  
North Africa 1940-42!!”**

# DECISION IN THE DESERT

"YOU are in Command — North Africa 1940-42!!"

By Sid Meier and Edward Bever

Dusk, October 24, 1944 – North Africa. Three hundred enemy tanks coming straight at you! Suddenly, the sky lights up with a thousand gun artillery barrage! The Battle of El Alamein begins! YOU ARE IN CHARGE!! Experience the thrill and excitement of one of history's greatest events. The action is non-stop in this accelerated real-time simulation. You'll be in the thick of this action packed strategic simulation in minutes even if you've never played a simulation before!

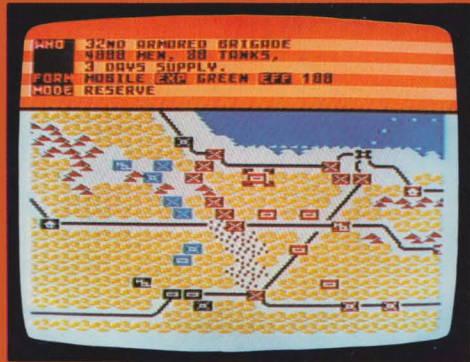

Actual Screen Picture

Decision in the Desert is a "Command Series" product with real-time, continuous action. You're in command as you lead the armies of either side or compete head-to-head between the two opposing generals. The computer handles all the rules.

Decision in the Desert is an historically accurate, fast moving simulation with colorful animated graphics and sound! Best of all you'll be deploying tanks, artillery, air cover, and your combat divisions in minutes even if you've never played a strategic Simulation before! Like the REAL generals...

**The Decision is up to YOU!!!**

Try these other exciting simulations from MicroProse:



"YOU are in Command  
— D-Day to the Battle  
of the Bulge!!"



Thrilling Head-to-Head  
Sabre Jet Aerial  
Dog Fighting!



Exciting Speech and  
Graphic Air Traffic  
Control Action!!!

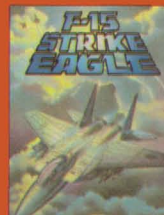

Challenging and Exciting  
Air Combat from the  
Modern Electronic Cockpit!

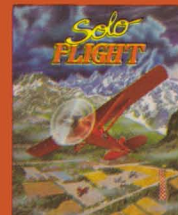

As Close to the  
Real Thrill of Flying  
as You Can Handle!

## MicroProse Software

120 Laketront Drive, Hunt Valley, Maryland 21030 (301) 667-1151

Commodore-64, Atari, Inc., IBM and Apple are registered trademarks of Commodore Business Machines, Inc., Atari, Inc., International Business Machines, Inc., and Apple Computer, Inc., respectively.

# Decision *in the* Desert



**MicroProse Software**

120 Lakefront Drive, Hunt Valley, MD 21030  
(301) 667-1151

**"YOU are in Command —  
North Africa 1940-42!!"**

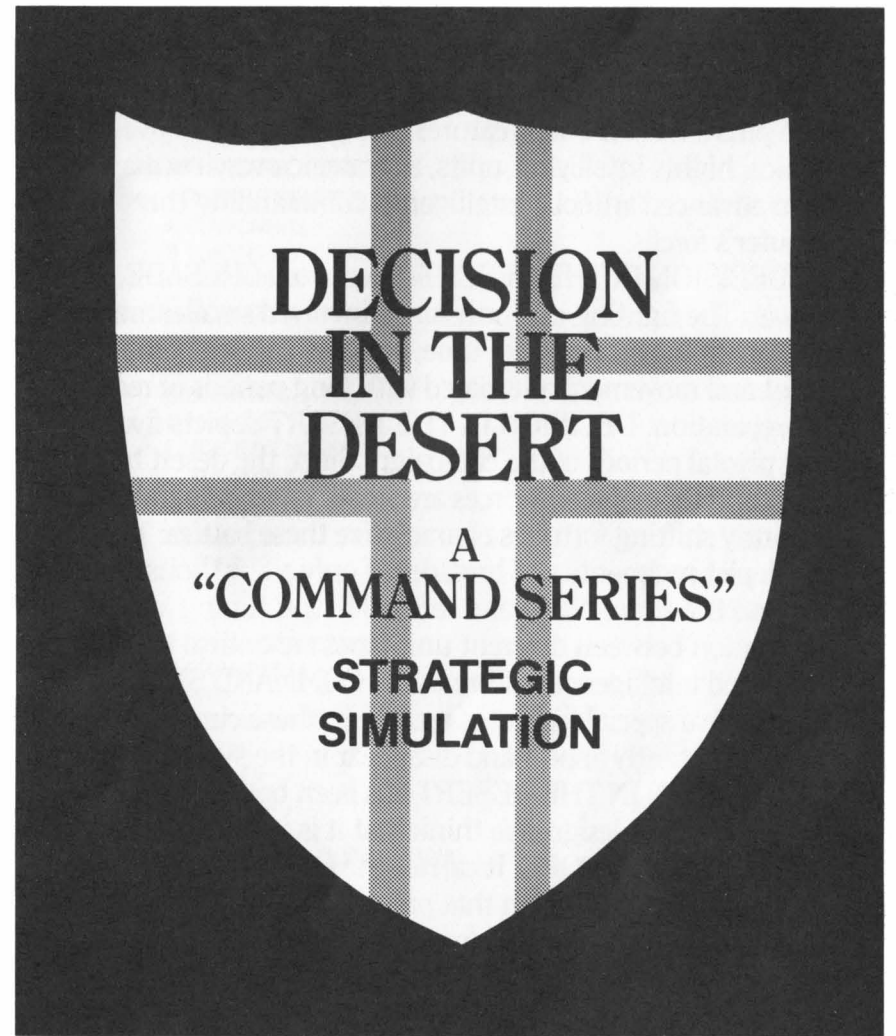

**DECISION  
IN THE  
DESERT**

A  
"COMMAND SERIES"

**STRATEGIC  
SIMULATION**

**EIGHTH ARMY  
1940-42**

**MICRO PROSE**  
SIMULATION • SOFTWARE

120 Lakefront Drive, Hunt Valley, MD 21030 (301) 667-1151  
©1985

## A note from the designers...

DECISION IN THE DESERT is the second of the COMMAND SERIES simulations. Like its predecessor CRUSADE IN EUROPE, DECISION IN THE DESERT puts YOU in command of some of the great battles of World War II. As in CRUSADE, this simulation gives you continuous "accelerated realtime" action plus a host of other features that gamers want: lively graphics, highly intelligent units, a strategic overview map, and an advanced artificial intelligence commanding the computer's forces.

DECISION IN THE DESERT differs from CRUSADE, however. The fighting in North Africa involved smaller armies over a much longer period of time, so short periods of intensive combat and movement alternated with long periods of recovery and preparation. DECISION IN THE DESERT depicts five of the short, pivotal periods of the campaign. Since the desert terrain is open and the opposing forces are small, rapid maneuvers and constantly shifting fortunes characterize these battles. The units depict regiments and brigades of only a few thousand men apiece, so the simulation has a tactical flavor; timing and coordination between different unit types are critical to victory. The limited intelligence feature of the COMMAND SERIES system adds a special feeling of realism in these circumstances, as units constantly appear and disappear in the swirl of battle.

DECISION IN THE DESERT has been both a challenge and a pleasure to design. We think that it is a worthy successor to CRUSADE IN EUROPE. It carries the COMMAND SERIES system into a new situation that presents new challenges and new insights into one of the great campaigns of the Second World War. Once again we hope that our efforts will bring you many hours of exciting and enlightening entertainment.

*Sid Meier*  
*Ed Bever*



30TH CORPS

# DECISION IN THE DESERT

## TABLE OF CONTENTS



BRITISH 13TH CORPS

INTRODUCTION, OVERVIEW AND QUICK START INSTRUCTIONS .....	4
Section I - GETTING STARTED .....	6
A. COMPONENTS .....	6
B. LOADING INSTRUCTIONS .....	6
C. SELECTION OF GAME OPTIONS .....	8
Section II - HOW TO PLAY .....	9
A. THE SCREEN .....	9
B. PACE OF PLAY .....	10
C. COMMANDS .....	12
D. MESSAGES .....	14
E. VICTORY CONDITIONS .....	16
Section III - HOW TO PLAY WELL .....	18
A. BEFORE YOU BEGIN .....	18
B. GAME SCALE .....	18
C. UNIT TYPES .....	18
D. EXPERIENCE .....	22
E. EFFECTIVENESS .....	23
F. COMMANDS AND MODES .....	23
G. FORMATIONS .....	24
H. SUPPLY .....	24
I. REINFORCEMENTS AND REPLACEMENTS .....	25
J. TERRAIN .....	25
K. WEATHER .....	27
L. MOVEMENT .....	27
M. COMBAT .....	28
N. EXAMPLE OF PLAY: SIDI BARRANI .....	29
Section IV - NOTES .....	31
A. HISTORICAL NOTES .....	31
B. RECOMMENDED READINGS .....	41
Section V - SCENARIOS .....	43
1. SIDI BARRANI .....	43
2. OPERATION CRUSADER .....	46
3. GAZALA .....	48
4. FIRST ALAMEIN .....	51
5. ALAM HALFA .....	53

© Copyright 1985 by MicroProse Software.  
120 Lakefront Drive, Hunt Valley, MD 21030 (301) 667-1151  
Original Software by Sid Meier, and Ed Bever, Ph.D.

Apple Conversion by Jim Synoski

IBM Conversion by Don Awalt

Commodore 64, ATARI, IBM PC/PC JR and APPLE are registered trademarks of Commodore Business Machines Inc., Atari Inc., International Business Machines Inc., and Apple Computer Inc., respectively.

Portions produced using copyrighted products of Monarch Data Systems and Drive Technology, Ltd.

APPLE: Operating system is copyrighted by Apple Computer, Inc., with portions also copyrighted by Diversified Software Research, Inc.

Integer Runtime Library copyrighted by Galfo Systems.

## INTRODUCTION

DECISION IN THE DESERT is an operational level simulation of five of the most important battles of the North African campaign. The first, SIDI BARRANI, recreates Britain's early victories over the Italian army, and serves as an introduction to the system. The second, OPERATION CRUSADER, simulates the sprawling and confused fighting in the winter of 1941 that broke the Axis siege of Tobruk and drove the German and Italian armies far back into Libya. The third, GAZALA, shows the German General Erwin Rommel at his finest, as his Afrika Korps swept back across the desert to defeat the British army and storm into Tobruk. The last two scenarios reproduce the bitter fighting at El Alamein: the FIRST BATTLE OF ALAMEIN and the BATTLE OF ALAM HALFA, in both of which Rommel tried and failed to push past the British into the Nile Valley. In the First Alamein, Rommel lost his chance to drive through the British before they recovered from the disaster of Gazala. In the battle of Alam Halfa, Rommel first confronted Bernard L. Montgomery, and dashed his army in vain against the solid defenses this new adversary had forged. Rommel was the first German general to feel the weight of Allied material superiority and the emergence of commanders who knew how to use it.

Each of the five scenarios includes several variants. SIDI BARANNI introduces the system with a short variant recreating the initial spectacular British advance. It also includes two longer variants that present greater challenges to your generalship. OPERATION CRUSADER presents both the historical situation and a "what-if" variant in which Rommel gets to storm Tobruk before the British field forces are ready to attack him. GAZALA and FIRST ALAMEIN both include variants of different lengths, while ALAMHALFA contains both an historical variant and a "what-if" variant that explores "what-if" Rommel had had more men and material when attacking Montgomery.

COMMAND SERIES simulations can be played by one player against the computer or by two players, head to head against one another. Either way they are fast moving and easy-to-play, while including a wealth of detail and historical realism. Play balance can be adjusted so that players ranging from beginners to expert strategists will find the computer to be a comfortably challenging opponent. Furthermore, two players of widely differing abilities can play a satisfying game against each other!

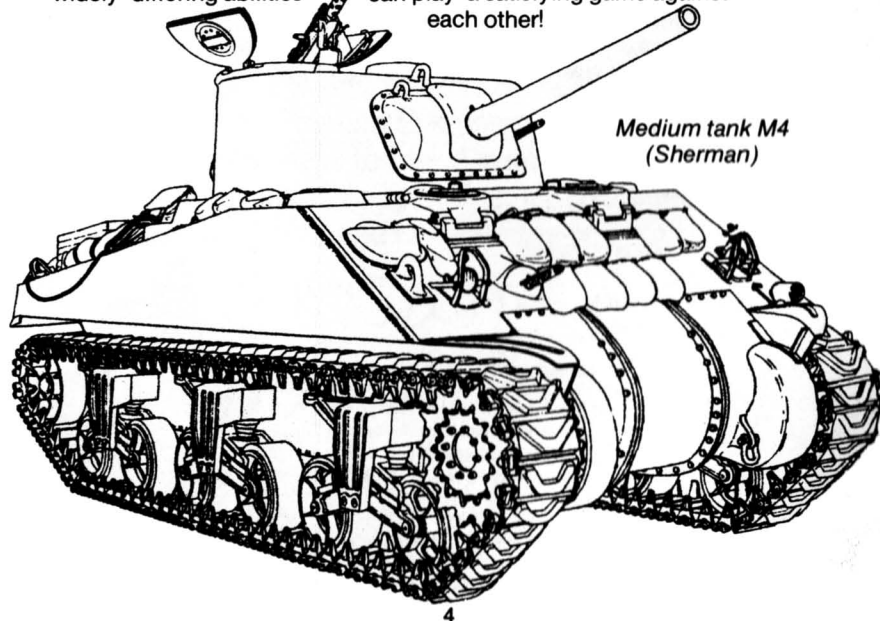

## RULES ORGANIZATION

This booklet is organized into five main sections. Section I, "Getting Started", tells you how to load the simulation and choose among the various options. Section II, "How to Play", describes the basics of how to control your troops. After reading Section II, you should be able to play. Section III, "How to Play Well", provides more detail on the game mechanics and some tips on strategy and tactics. Section IV, "Notes", includes Historical Notes giving a brief description of the actual campaign, and recommended readings. Section V, "Scenarios", presents the starting conditions, duration, reinforcement schedules, victory conditions, and special rules for each of the scenarios and variants.

## OVERVIEW OF PLAY

Play in DECISION IN THE DESERT proceeds in accelerated real-time. This means that there are no turns; instead time flows by continuously, as in real life. The playing field is a map of the area in which the campaign took place, and the "pieces" represent actual units that took part in it. Players can learn the strength of and issue orders to a unit by moving a cursor over it and pressing either the joystick trigger or the appropriate key on the keyboard. By ordering his forces to move, attack, and defend, the player attempts to gain enough Victory Points to win. Victory Points are awarded for conquest of territory, destruction of enemy units, and infliction of casualties. Play proceeds until certain "critical" locations are taken or a prescribed amount of gametime has elapsed.

## QUICK START

Players can begin playing quickly by skimming Sections I and II, booting the introductory scenario, reading along with the Example of Play (Section III, Part N), and referring to the Player Aids on the Center Insert.

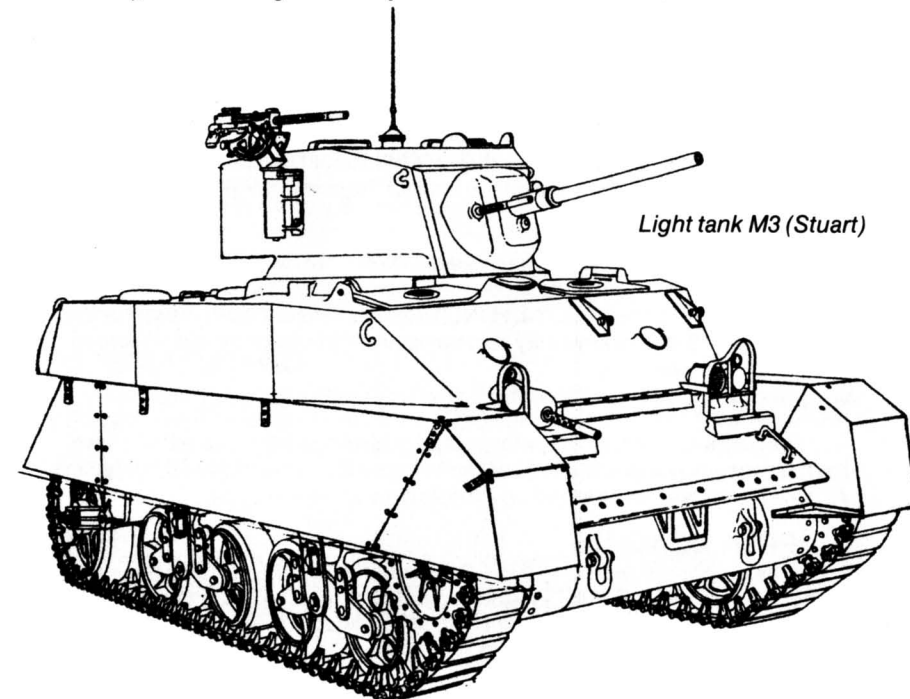

# Section I - GETTING STARTED

## A. LOADING AND SPECIAL INSTRUCTIONS

### 1. ATARI LOADING

This program requires an ATARI 400/800/1200 or XL with at least 48K of memory and a disk drive. To load the program, remove all cartridges from the computer, insert the game disk in your disk drive, and power your system up. If a joystick is used, it should be connected in the first slot.

#### KEYBOARD

To move the cursor from the keyboard, use the four standard cursor control keys (Up, Down, Left, Right). If these keys are pressed by themselves the cursor will move in single steps. If these keys are pressed while holding down the CONTROL key, the cursor will move in large steps. The < and > keys are used to change the game speed during play. The SPECIAL FUNCTION key referred to in the text is the START key. The OPTION and SELECT keys may be used on the option selection screen if no joystick is available.

#### SPECIAL NOTES

Due to memory limitations, the "Flashback" feature is only available on XL model computers with 64K of memory. The "Overview" feature may not work correctly on some early 400/800 machines which do not include the "GTIA" graphics chip. Also due to memory limitations, the "GENERAL" command is not available in the ATARI version of the program.

Prepare a blank, formatted disk before playing. Use this disk if you wish to save the game at any point. You will be asked to type a file name of 1 to 8 characters. At least 20 games can be saved on a single disk. If you forget the name of a file, you may examine the disk directory using Atari DOS, consult your DOS manual for details.

### 2. COMMODORE 64 LOADING

Power your system up and insert the game disk in your disk drive. Type LOAD "", 8 followed by RETURN. When the computer responds with READY, type RUN and press RETURN. Loading will take about 1 minute. If a joystick is used, use the connector nearest the back of the computer (Port #2).

#### KEYBOARD

Use the standard cursor control keys (lower right) to move the cursor. To move the cursor in large steps use the following keys: Up="<", Down=">", Left=">", Right=">.". The SPECIAL FUNCTION key referenced in the text is the f7 key. The f1, f3, and f5 keys may also be used on the option selection screen if no joystick is available.

#### SPECIAL NOTES

Prepare a formatted disk before playing. Use this disk if you wish to save the game at any point. You will be asked to type a file name of 1 to 20 characters. At least 20 games can be saved on a single disk.

### 3. APPLE LOADING

This program requires an APPLE ][+ w/64K memory, an APPLE //e or an APPLE //c. The APPLESOFT language must exist in ROM. To load the program, place the program diskette in your boot disk drive and turn on the computer. The program will boot automatically. Leave the disk in the drive unless told otherwise by the program.

## KEYBOARD

The CAPS LOCK key must be down.

If a joystick is not plugged in then be sure to select the KEYBOARD ONLY option.

The standard cursor keys will move the cursor around the screen. On the APPLE ][+ the "P" serves as an Up cursor key and the ";" serves as the Down cursor key. The SPECIAL FUNCTION KEY referred to in the text is the RETURN key.

"S" - Press this key and you will save the current game. To initialize a saved games disk, select INIT from the save screen. To save a game position, type a number from 1 to 32. You will then be allowed to type a 15 character description of that game. Press RETURN only in order to return to the game without saving a game.

"L" - Press this key and you will load a saved game. From the load screen, type the number (1-32) of the game that you wish to load.

"N" - This key will change the graphics for the type of monitor available. Pressing this key will toggle between the color character set and the Black & White Character set.

#### SPECIAL NOTES - 64K Version

The Flashback feature is not available.

The Day/Night indication is the background color of the time/weather line, white for day, black for night.

The background color of the text display area is constant. The indication of which is the currently active side is the word (BRITISH, AXIS) at the end of the time/weather line.

British units are Red, Italian units are Blue, and German units are Purple. With the Black & White Character Set the British Units are solid and the Axis units are outline drawings.

On the Strategic Overview map the British units are Green and the Axis units are white.

The cursor is a solid white rectangle.

#### SPECIAL NOTES - 128K Version

The background color of the text display area indicates the currently active side. In addition there is a single letter (B,A) at the end of the status line which also indicates the active side.

The Monitor Option is described in the 64K SPECIAL NOTES.

DAY/NIGHT indications and unit colors are the same as described elsewhere in the manual.

The cursor is a Black & White rectangle.

If you have 128K of memory an additional option has been added to the main selection screen to allow you to select either a 128K game or a 64K game.

NOTE: The 128K version of this program uses the double hi-res graphics mode. APPLE //e's must be Rev. B or greater to use this mode.

### 4. IBM LOADING

This program will operate on both the IBM PC and PC Jr. Place the disk in Drive A, and either turn your computer on or press the control-Alt-Delete keys simultaneously if your computer is already on. (Note that DECISION IN THE DESERT cannot be copied onto a hard disk). This will get you to the first menu screen. Follow on screen instructions.

#### KEYBOARD

To move the cursor from the keyboard, use the four standard cursor control keys (Up, Down, Left, Right). If these keys are pressed by themselves the cursor will move in single steps. If these keys are pressed while holding down the SHIFT key, the cursor will move in large steps. The < and > keys are used to change the game speed during play. The SPECIAL FUNCTION key referred to

in the text is the START key. The OPTION and SELECT keys may be used on the option selection screen if no joystick is available.

## OPERATIONAL CODES

In order to identify yourself as the army commander, you must enter the correct operational code day word when prompted by the computer. For example, the computer prompts "ENTER OPERATIONAL CODE: DAY 1" - FIND THE CODE DAY BOX in the instruction manual, note the code word. Type this into the computer and press RETURN. If the incorrect code is entered, you will only be allowed to play the first scenario and variant for 2 days.

CODE DAY CARD	
DAY	CODE RESPONSE
1	GYMNAST

EXAMPLE:

## B. SELECTION OF GAME OPTIONS

### 1. SCENARIO SELECTION

The first selection screen allows you to select one of the available scenarios. Type the number of the scenario you want to play. The scenarios are described in Section V of this booklet.

### 2. VARIANT SELECTION

The second screen allows you to select one of the available variants to the scenario you have chosen. Type the number of the variant you want to play. The variants are discussed along with the scenarios in Section V.

### 3. OPTIONS

The third screen gives you control over various game characteristics.

(1) Each side may be controlled either by the computer or by a player. Thus, you can play DECISION IN THE DESERT head to head against a human opponent, or solitaire against the computer, which can take either side. You can even watch the computer play against itself if you want!

(2) The two sides may have full or limited intelligence about the location of enemy forces. With full intelligence, all enemy units are displayed on the map; with limited intelligence, only those which are in or have recently been in contact with the player's units are displayed.

(3) You may choose to have units represented by standard military symbols or by icons. The icons are simpler to understand than the symbols, but they convey less information about the types and strengths of the units they represent.

(4) You may adjust the play balance to handicap one of the players (or the computer). This adjustment will increase the power of the favored side's pieces. However, should the handicapped side win, it's ranking will be correspondingly greater. BEGINNING PLAYERS SHOULD SELECT AT LEAST ONE LEVEL OF ADVANTAGE FOR THEMSELVES. EXPERIENCED PLAYERS SHOULD GIVE THE COMPUTER ONE OR TWO LEVELS OF ADVANTAGE.

(5) A speed parameter may be adjusted to control the speed of the game, the length of time messages are displayed, etc. Speeds include slow, medium, and fast.

## Section II - HOW TO PLAY

Although this simulation is incredibly sophisticated, it is amazingly simple to play! The computer takes care of all calculations, enforces the rules, traces supply lines, keeps track of casualties and supply levels, implements your commands, and informs you of the results. This puts you in the position of a real commander, free to concentrate on formulating a strategic plan and directing your forces to implement it.

## A. THE SCREEN

### 1. THE MAP

When the game begins you will see a map depicting all or part of the area in which the scenario you have chosen takes place. This map represents the militarily significant terrain over which the armies will fight. The symbols are identified and their effects summarized in Section III, Part J, and on the center color page.

Note that in some scenarios the map area used in play is larger than the size of the screen. To view off-screen areas, use the cursor to scroll the map (for cursor controls see below, Number 6).

During the day, the background color of the map is tan; at night, it is black.

### 2. THE HEX GRID

Although you cannot see it, the map is based on a hexagonal grid. Like the squares on a chessboard, these hexes define the location of pieces and regulate their movement. Each hex contains one type of terrain, and can contain one unit. The cursor used in play is square, but basically defines the area of one hex. When you move it, it jumps from one hex to the next. You will notice that it moves in a straight line across the map, but zig-zags when moving up and down.

### 3. THE TEXT DISPLAY AREA

The top five lines of the screen are a text display area where messages, status reports, and other information will appear during the course of play. These are described in Part D below. In two player games, the color of the text display indicates which side is able to give orders (blue or grey for the Axis, red for the British player).

### 4. THE TIME/WEATHER STRIP

Between the text display area and the map is a line on which the current time of day, date, and weather conditions are displayed.

### 5. THE UNITS

The Axis and British armies are represented on the map by either conventional military symbols or icons. The icons and symbols are identified on the center color insert, and are discussed in detail in Section III, Part C.

Whichever representation is chosen, British units will be Red, German units will be Black, and Italian units will be blue.

### 6. THE CURSOR

At the center of the map you will see a large blinking square cursor. You can move this cursor around the map with a joystick or the cursor command keys.

If you attempt to move the cursor off the edge of the screen, the map will scroll in that direction to the limits of the area incorporated in the scenario.



The cursor is your primary tool for giving orders. When you place the cursor over one of your units, you are ready to establish contact with the local commander. If you push the joystick trigger once or the SPACE bar, you will receive a status report from that unit in the text display area. If you hit the trigger again you will be able to select a command for the unit from a menu displayed in the text area. Or, if you prefer to use the keyboard, you may enter an order without using the menu by pressing the appropriate key. The Commands are discussed in Part C below, and summarized on the center color page.

If you place your cursor over an enemy unit and press the trigger or SPACE bar, you will receive a status report containing all available information about that unit (if any). Note that you may not give orders to enemy units!

## B. PACE OF PLAY

In contrast to most strategy games, DECISION IN THE DESERT does not proceed by turns. Instead, the computer conducts the activities of units continuously, while a clock ticks off the simulated passage of time. The computer processes each unit approximately once every four game hours.

### 1. INTERRUPTION OF PLAY

(1) FREEZING THE GAME: The player(s) can freeze play by pressing "F".

(2) OTHER TIMES: The game will freeze whenever you press "O" to view the overview map, "T" to view the terrain, "Q" to change the active side, or "S" to save the game.

### 2. ENTERING ORDERS

You can enter orders at any time during play except during the supply allocation phase, or while in the flashback mode. Note that there will generally be a delay between the time you enter an order and when the unit actually executes it.

CODE DAY CARD	
DAY	CODE RESPONSE
1	GYMNAST
<i>Light tank L3/35</i>	

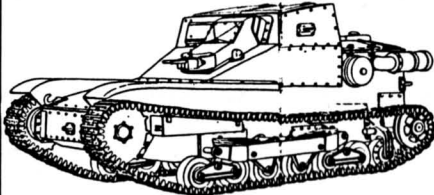

### 3. TWO PLAYER GAMES

Because DECISION IN THE DESERT is not played in turns, two player games can be structured however the players feel most comfortable.

(1) THE ACTIVE PLAYER: Only one player can be "active", at a time.

Only the active player can enter orders, and if the limited intelligence option has been selected, only his units and those of the enemy that his can see will be displayed. Which player is active is indicated by the color of the text display area: it will be grey or blue for the Axis and red for the British.

(2) CHANGING THE ACTIVE PLAYER: Press "Q" in order to change the side that is active. Play will be frozen, the units will disappear, the text display

will change color, and you will be prompted to press "T" to display the units on the map and resume play.

(3) STRUCTURE OF A TWO PLAYER GAME: You can structure two player play however you feel most comfortable. Two possible approaches are "free flow" and "daily turns". In "free flow," players use the "Q" command to change the active player whenever the inactive player wants. If both players want to issue orders or gain information at the same time, simply freeze the game until both have done so, and then unfreeze it to let play proceed. In "daily turns," players alternate being active for a simulated day.

CODE DAY CARD	
DAY	CODE RESPONSE
2	ALEXANDER
<i>Matilda Mark II</i>	

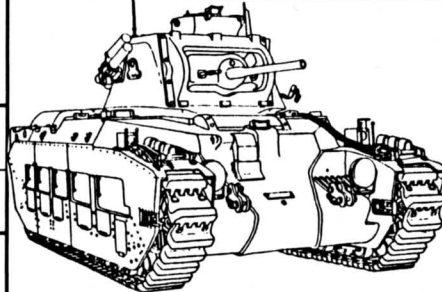

A unit that has been issued an action command can be assigned an objective simply by moving the cursor to the location desired and either pressing the joystick trigger or pressing "H" (for HERE, as in "MOVE . . . HERE!" or "ATTACK . . . HERE!"). If there is an enemy unit in the objective, the joystick trigger must be pressed TWICE: once to bring up the enemy's status report, and the second time to designate the hex as the objective. If there is a friendly unit already in the objective, the keyboard command "H" must be used.

Note that a unit given an action command does not have to be given an objective command. In this case, it will remain in or near its present position, acting when appropriate on its own initiative to carry out the action ordered.

A ground unit ordered to ATTACK or DEFEND an objective will move to do so, but will move more slowly than if it were ordered to MOVE. The trade off is that the more quickly a unit moves, the longer it will take to prepare for combat and the more vulnerable it will be if attacked.

### 4. INFORMATION COMMANDS

Information commands enable you to learn certain things about the game while it is in progress.

(1) To obtain information about a specific unit, move the cursor over it and press joystick trigger or the "SPACE" bar.

(2) To learn the name and status of a major city (or other important location), place the cursor over it and press "C".

(3) To note the characteristics of the general commanding a friendly unit, place the cursor over it and press "G".

(4) To view the terrain without the units superimposed press "T" (press it again to bring them back).

(5) To move the cursor over the unit which sent the most recent message "W" (for "who?"). In addition to moving the cursor, this command will cause the action signal to be displayed in the lower right area of the text display (for an explanation of action signals, see below, Part C).

(6) To find out who's winning press "?".

(7) To view the overall disposition of forces, press "O" to display the strategic map. This map shows on one screen the land and sea areas

incorporated in the whole game map and the location of all units. A blue line delineates the area in play in the current scenario. Press any key to return.

## C. COMMANDS

There are two types of command which control the activities of your units: the four ACTION COMMANDS and the OBJECTIVE COMMAND. These are used to specify what a unit is to do and where it is to do it.

In addition, INFORMATION COMMANDS enable you to acquire information about the game, and UTILITY COMMANDS allow you to control certain activities of the computer hardware.

### 1. ACTION COMMANDS

The four action commands are used to tell a unit what type of activity to perform. The four commands are MOVE, ATTACK, DEFEND, and (go into) RESERVE.

(1) A ground unit ordered to MOVE will prepare to relocate to another position on the map. A unit's ability to move normally is affected by terrain, inhibited by adjacent enemy units, and blocked by any unit directly in its path (although it may, of course, be able to move around it). Air units cannot move, although they can attack over great distances.

(2) A unit ordered to ATTACK will seek to initiate combat with an enemy unit. A ground unit must be adjacent to the enemy in order to ATTACK; an air unit can ATTACK an enemy unit anywhere on the map.

(3) A unit ordered to DEFEND will prepare to resist enemy attacks. An air unit DEFENDS as if it were a ground unit.

(4) A unit ordered into RESERVE will recover from the effects of combat.

In order for a unit to be issued one of these orders, it must be under the cursor. The command can then be entered either via the joystick or the keyboard.

To use the joystick, press the trigger once, which will bring up the unit's status report, and then press it again, which will bring up a menu of action commands. Use the joystick to move the arrow up or down to the appropriate line, and then press the trigger for a third time. To exit the menu without issuing a new order, select CANCEL.

To use the keyboard, simply press the appropriate key ("M" for MOVE, "A" for ATTACK, "D" for DEFEND, and "R" for RESERVE).

Note that a unit that is doing one thing will need time before it will begin to undertake a new activity.

CODE DAY CARD	
DAY	CODE RESPONSE
3	BREVITY
Tank M11/39	



## 2. THE OBJECTIVE COMMAND

The objective command assigns a unit that has been issued an action command a location on the map as its objective. A ground unit will attempt to move to the designated location and perform the activity specified by the action command; an air unit assigned to ATTACK will do so without moving if the target is within range.

CODE DAY CARD	
DAY	CODE RESPONSE
4	AFRICA
Rolls-Royce armoured car	

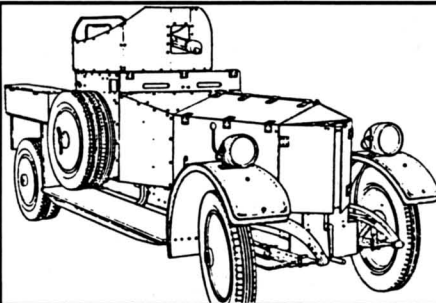

### 4. UTILITY COMMANDS

(1) To save the current game situation, press "S". A game can be saved at any point during play. Do not attempt to save a game onto the program diskette; prepare a blank formatted diskette before you begin play. You will be prompted to enter a file name for the saved situation. If a file with this name already exists on the disk, the old file will be deleted and the new information will replace it. Once the save is completed you may continue playing the game. Be sure to put the program disk back in the drive before proceeding. (If you pressed "S" by mistake, just press RETURN to return to your current game.)

(2) To load a previously saved game press "L", type the file name used when the game was saved and press RETURN. A game can be loaded at any point during play but note that the current game will be lost unless you save it first. If you plan to load a previously saved game, be sure to select the same Scenario and Variant which were selected when the game was saved. If you don't, the message "SCENARIO MISMATCH" will appear.

(3) To freeze the game action press "F". Press "F" again to un-freeze it. No activity will take place as long as the game is frozen, but you may ask for information and give commands.

(4) You can review the current game by pressing "B". The computer stores the midnight positions once a day for the most recent fifteen days. You may scroll the map using the cursor control keys in this mode.

(5) To change the side which can enter orders via the joystick or keyboard, press "Q". Note that the text display will change color to indicate which side is currently active (blue or grey for the Axis, red for the British). When playing the two player game, this command will determine which player is active. When playing solitaire, this command will cause you and the computer to switch sides.

(6) To change the unit display from icons to symbols or back, press "U".

(7) To change the speed of the game during play, press "+" or "-" (Commodore) or ">" or "<" (Atari). The possible speeds cycle from "SLOW" to "MEDIUM" to "FAST" in either direction.

## D. MESSAGES

During the game you will receive reports from and about your units. Action signals are sounds and icons that flash directly over the units in question. Text messages are longer reports and are displayed in the text display area of the screen above the map.

### 1. ACTION SIGNALS

Sounds and flashing icons are action signals. The sounds indicate that some activity is taking place; the icons appear directly over a unit which has something to report, both to indicate its location and convey the general nature of the message.

(1) The **SOUNDS** include a bell to alert you that a new message is being displayed, the sound of a tank grinding along to indicate that a piece is moving, the rattle of a machine-gun to indicate that a unit is attacking, and a slamming noise whose intensity conveys the amount of damage inflicted on the defender.

(2) The **ICONS** include a **FIGURE SHOOTING A GUN** to identify an attacking unit, a **THUNDERBOLT** to indicate a unit being attacked, and a **FIGURE ON ITS KNEES** to indicate a unit that encountered too much opposition to continue to attack. They also include a **RUNNING FIGURE** to mark a unit forced to retreat, an **EXCLAMATION POINT** to indicate a unit which has come into contact with an enemy unit, and a **QUESTION MARK** to indicate that a unit has arrived at its objective and is awaiting further orders. Furthermore, **ARROWS** or **WALKING FIGURE** indicate the objective of a unit whose status is being displayed, a **TRUCK** identifies a unit that has run out of supplies, and a **TRUCK** icon is also used to show the line of supply being traced to each unit during the supply phase. Finally, a **HAPPY FACE** appears whenever your units capture an enemy held town.

### 2. UNIT STATUS MESSAGES

Whenever you move the cursor over a unit and press the joystick trigger or "SPACE" bar, all available information about it will be displayed in the text display area. If it is a friendly unit, the information will be complete and accurate. If it is an enemy unit, the amount and accuracy of the information will depend on how recent and extensive its contact with your units has been.

The following is an example of a friendly unit's status message:

- (1) 7TH ARMoured BRIGADE
- (2) 2800 MEN, 119 TANKS,
- (3) 3 DAYS SUPPLY.
- (4) FORM: DEPLOYED EXP: VETERAN EFF: 30
- (5) ORDR: ATTACK (LOCAL COMMAND)

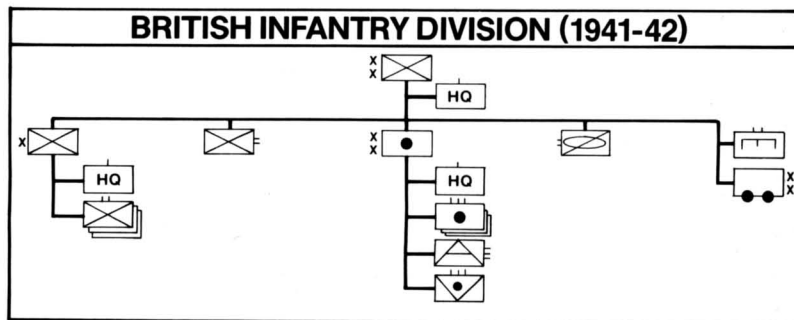

This sample status message provides the following information:

- (1) The unit under the cursor is the 7th Armoured Brigade.
- (2) The 7th Armoured Brigade currently contains 2800 men and 119 tanks. This number may decrease as the result of combat or attrition. Replacements may augment these numbers (see Section III Part I).

(3) The unit currently has supplies for 3 days of normal operations. Supplies are consumed at a faster rate if the unit moves frequently or engages in combat. A unit will obtain resupply each night from a headquarters or a supply depot if the shortest route to it (by movement time) is unblocked by enemy units. For more information about supplies see Section III, Part H.

(4) The unit is in DEPLOYED formation. A unit ordered to perform a particular action will automatically enter the appropriate formation, although it will take some time to do so. For more detail about the various formations, see Section III, Part G.

The experience level of this unit is VETERAN. This reflects the unit's prior history. Units gradually gain experience as they engage in combat. For a full discussion of experience levels see Section III, Part D.

The unit's current effectiveness rating is 90%. The effectiveness level decreases rapidly as a unit is engaged in combat. Units recover their effectiveness if they are allowed to rest. See Section III, Part E.

(5) The most recent order issued to this unit was to ATTACK. Furthermore, the display indicates that the local commander is in charge of selecting his own objectives (no specific location has been assigned as its objective).

**IMPORTANT NOTE:** In addition to the information contained in the text display, whenever a unit's status is displayed, an arrow or walking figure will appear over the unit's objective if it is visible on the map.

<b>CODE DAY CARD</b>	
DAY	CODE RESPONSE
<b>5</b>	<b>MERCURY</b>
<i>Carro armato tipo M13/40</i>	

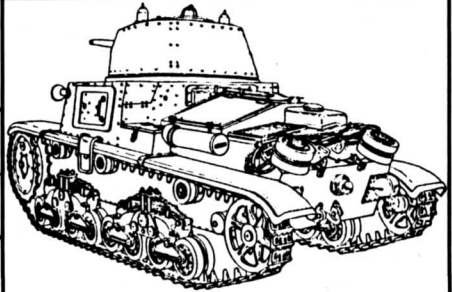

### 3. ACTIVITY REPORTS

As the battle proceeds, you will receive periodic messages from your units reporting important developments on the battlefield.

**"WE ARE IN CONTACT WITH ENEMY FORCES."**

A unit which was previously not in contact with the enemy has detected an enemy unit.

**"WE HAVE REACHED OUR OBJECTIVE, AWAITING FURTHER ORDERS."**

The unit has reached the objective which you assigned. Units in Offensive Mode will revert to local command and attack nearby units. Units in Movement, Defensive, and Reserve modes will rest and await further orders.

**"WE ARE ATTACKING, OUR LOSSES ARE HEAVY (MODERATE, LIGHT, VERY LIGHT)."**

A unit is attacking the enemy. The commander reports how well the attack is going.

"ENEMY RESISTANCE TOO STRONG, HEAVY LOSSES, ATTACK MUST BE HALTED."

An attacking unit has encountered such heavy resistance the attack cannot proceed.

"WE HAVE CAPTURED (TOBRUK)."

A unit has occupied a significant city or location.

"WE ARE RETREATING."

A unit has been attacked and forced to retreat one hex.

"WE HAVE BEEN OVERRUN."

A unit has been attacked and forced to disperse. The unit is temporarily eliminated but will return later in the game.

"MUST SURRENDER."

A unit has been eliminated.

CODE DAY CARD	
DAY	CODE RESPONSE
6	SUBSTANCE
<i>Panzerkampfwagen III (Ausführung F)</i>	

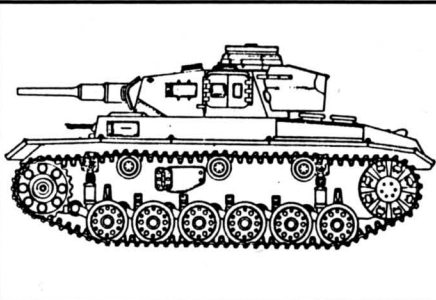

#### 4. STATUS REPORT

Once each afternoon, and whenever you press "?", you will receive a status report on the game in the text display area. This displays a chart showing the losses of men and tanks (or other heavy equipment) suffered by each side and the number of victory points for capturing territory each has gained. It will state which side is currently ahead, and by roughly how much.

#### VICTORY CONDITIONS

Each scenario and variant has its own victory conditions, which are detailed in Section V. In general, your performance will be evaluated on the basis of your ability to capture or defend territorial objectives and to inflict losses on the opposing army.

1. Major cities and other strategic locations are assigned certain Victory Point values. They are shown on the maps in Section V, and can be learned during play by using the "C" command. The Victory Points for each location are assigned to the last side to have a unit in it, or the side which controlled it at the beginning of the game if neither enters it.

2. In most scenarios, certain locations are designated "critical locations." Their names are underlined on the scenario maps. Capture of a number of these locations specified in the variant results in an automatic decisive victory.

3. Each man and tank lost benefits the opposing player slightly. These individual losses are only significant if the Victory Point totals are equal, or if one side has lost substantially greater numbers than the other.

4. Victory and defeat are graded according to their severity. The degrees of severity are determined by the ratio of VP between the winner and the loser. The degrees of severity (with the point ratios) are:

(1) SLIGHT — This level of victory means that the winning side has less than one third more Victory Points than the loser. The game is very close.

(2) MARGINAL — The winning side has between one third and two thirds more Victory Points than the loser. Somewhat better, but still close.

(3) TACTICAL — the winning side has between two thirds more and twice as many Victory Points as the loser. A substantial victory.

(4) DECISIVE — The winner has between twice as many and two and a third times as many Victory Points as the loser.

(5) TOTAL — The victor has more than two and a third times as many Victory Points as the loser. An overwhelming victory.

5. During the course of play the game status report will include an assessment of who is currently ahead, which will be indicated by which side has the advantage. The gradations of advantage are the same as the grades of victory and defeat. However, please note that the side that needs to gain Victory Points to win will almost assuredly be behind for a considerable portion of the game. Players commanding this side should therefore not be discouraged by this assessment, but instead should concentrate on slowly reducing the opposition's margin of victory.

6. When the specified number of "critical locations" have been captured or at 6 p.m. on the last day of the scenario, the GAME OVER message will appear in the TIME/WEATHER strip and the game will be frozen. You may still examine the map and units and use the overview and flashback commands. When you have finished examining the final game situation, press "?" and you will proceed to the awards ceremony. Be sure you have the game disk in the disk drive at this point.

7. At the end of the game, you will be told the final level of victory and awarded a rank based on your performance. The ranks, from lowest to highest are:

- |                    |                    |
|--------------------|--------------------|
| Private            | Colonel            |
| Sergeant           | Brigadier-General  |
| Lieutenant         | Major-General      |
| Captain            | Lieutenant-General |
| Major              | Field Marshal      |
| Lieutenant-Colonel | Supreme Commander. |

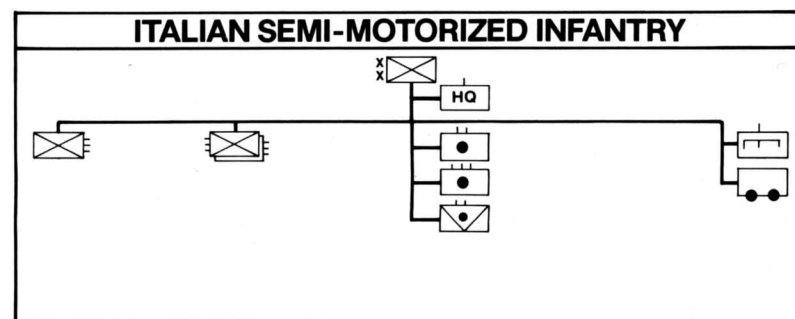

## Section III – HOW TO PLAY WELL

In order to become a credible commanding officer, you must become familiar with the capabilities of your units, the effects of weather and terrain, and the significance of various formations. In general, these relationships are fairly intuitive: it is easier to move in good weather than in bad, for example, and attacks are more likely to be successful over clear terrain than in mountains.

### A. BEFORE YOU BEGIN

When the game first appears, the units are programmed to attack or defend, depending on their historical disposition, and if the game is left alone they will begin to move and fight. However, before you begin to play, it is a good idea to freeze the action (press "F"), take a moment to survey the situation, and, if you are playing for the first time, familiarize yourself with the commands (Section II, Part C), the effects of terrain (below, Part J), and the capabilities and limitation of the units (below, Part C).

1. Look over the map, scrolling around if it takes up more than one screen. Referring to the terrain key (in the color center spread of this manual), look for patterns of terrain favorable to the offense and defense. You may want to use the "T" command to remove the units from view so you can see the terrain clearly. Locate the objectives given in the Scenario's Victory Conditions, and note how they relate to the other terrain: which areas protect them from attack, and which offer easy access.

2. Survey the units, your own and the enemy's. Use the Unit Table on the Command Card to identify the types of units that will be involved in the coming battle, and use the unit status display on the screen to determine their strengths. Look also at the pattern of deployment, how the unit's locations relate to each other, to the terrain, and to the objectives.

3. Formulate at least a vague plan of action, taking into account the forces under your command, those of your enemy, the terrain, and the objectives. If you are on the offensive, how can you best get your units from where they are now to where they need to go, given the enemy's forces and the lay of the land? If you are defending, try to anticipate the enemy's most likely routes of advance, and think of how best to counter them. If either you or the enemy is expecting reinforcements, consider where and when they are likely to appear, and take this into account in your plans. Do not lock yourself into an inflexible approach, but do not allow yourself to play only from moment to moment.

4. If you know what you want some units to do to begin with, issue them their orders before you press "F" to begin play.

### B. GAME SCALE

Each hex represents an area of about three miles square. The simulation proceeds in accelerated real time; each unit receives a movement opportunity approximately every four hours. Units are generally brigades and divisions (2,000-15,000), although many other smaller and ad hoc formations are included.

### C. UNIT TYPES

Each army is made up of an assortment of units of various types. Each unit type has its own particular strengths and weaknesses. A good commander learns to use his units in the roles for which they are best suited.

## 1. ITALIAN GROUND COMBAT UNITS

- (1) Blackshirt and Libyan Infantry Divisions: While the Libyans were fierce fighters and the Blackshirts had a fanatical tinge, these units were under-strength (around 7500 men) and short on modern heavy support weapons. They did not perform well, and disappeared from combat after the first campaign. The Libyans' most notable strength was their ample motor transport, but they were so quickly overrun that this played little part in the actual campaign, except perhaps to help motorize the British.

- (2) Regular Infantry Division: Containing about 10,500 men, Italian Infantry Divisions were organized as two regiments that usually stuck close together. They contained few motor transports, many disgruntled foot sloggers, and a core of skilled and dedicated artillerymen. Their equipment was of uneven quality, and their leadership generally poor.

- (3) Motorized Infantry Division: These units contained three regiments, for a total of about 12,500 men. Two were sent to North Africa, but one, Trento, was promptly stripped of its vehicles and so served as an overlarge infantry division. The other, Trieste, gave a lackluster performance as the running mate to the Ariete Armoured Division.

- (4) Italian Armour: Organized originally into Brigade groups, their poor performance in the opening battles led to the introduction of Armoured Divisions. These, however, still had only about 6500 men. They had a strong complement of tanks, but the best of these were poor, and the rest were useless. The amazing thing about the Italian army was not the poor morale of the men, but all the reasons for it.

- (5) Parachute Division: About 9,000 men strong, the parachute division sent late in the campaign performed with more determination than the average Italian unit. It was a help in the actual campaign, though it could have been decisive if it had been used against Malta instead.

## 2. GERMAN GROUND COMBAT UNITS

- (1) Panzer Division: In 1941, the German Panzer division was a well balanced and tightly integrated force. Containing about 14,500 men at full strength, it comprised a panzer regiment with 170 tanks, a panzergrenadier infantry regiment transported in trucks, a strong anti-tank battalion, and numerous supporting units. Subdivision into combined arms teams, known as Kampfgruppe, was widely practiced, although as time went on Rommel came to wield his Panzer Korps of two divisions more and more as a single mass. Like ships at sea, tanks on the desert had little reason to spread out and much to gain by staying together. And they had good reason to stay close to their supporting anti-tank guns, which were in turn protected by the infantry, for the German tanker's standard practice was to lure the British armour within artillery range, where the lumbering hulks inevitably fell victim to the longer-range guns concealed by the undulations of the desert floor.

- (2) Light Division: Formally structured along the lines of a mountain division, with very autonomous sub-units, light divisions were envisaged as mobile infantry units to be used in pursuit and flank protection for the fully motorized panzer divisions. To help them survive against motorized and armoured foes they were likely to encounter, they had a strong contingent of anti-tank weapons. The Fifth Light division was the first German unit in Africa, but it contained a full regiment of tanks, and was soon up-titled to the 21st Panzer division. The 90th Light division was formed from a number of independent regiments, and continued to have a rather ad hoc composition that varied considerably over time. The 164th Light division was flown over without its vehicles to help hold the Alamein line, which it did with gritty German professionalism.

(3) Parachute Brigade: One German parachute brigade was flown in to help hold at Alamein. While it performed admirably, it, like its Italian counterpart would have been better used to seize Malta. After some service as a complete unit, Rommel ultimately broke it up and distributed it among the Italian divisions to help hold them together.

(4) Miscellaneous small units: At different times, units operating apart from the bulk of the German divisions were grouped into ad hoc units. Most notably, two infantry regiments were brigaded together during the battle of Gazala, and the two reconnaissance battalions from the Panzer divisions were grouped together for Alam el Halfa.

<b>CODE DAY CARD</b>		
<b>DAY</b>	<b>CODE RESPONSE</b>	
<b>7</b>	<b>EXPORTER</b>	
<i>Cruiser tank A13</i>		

### 3. BRITISH GROUND COMBAT UNITS

(1) Infantry Brigades: The bulk of the British army was its infantry brigades. Originally they were weak in supporting arms, particularly anti-tank guns, and the rather loose structure of divisions hindered close combined arms cooperation. But by the battle of Gazala the British command had begun to reorganize the army into brigade groups, which married infantry units to a portion of the division's supporting arms. Only partially instituted by the time Rommel struck, the reorganization was completed as the lines coalesced at El Alamein, a process to which it contributed. Throughout the campaign, the British infantry had the inestimable advantage of relatively easy access to motor transport. From the end of the opening battles on, the British army in Africa was basically a motorized force.

(2) Support Groups and Motorized Brigade Groups: British Armoured division evolved from a very poor, tank heavy structure to a more balanced organization only slowly. The second reorganization in 1940 grouped two armoured brigades with 170 tanks each (and a few motorized infantrymen) with a Support Group containing a battalion of motorized infantry, several regiments of artillery, and the rest of the division's supporting services. With the rise of brigade groups, the divisional assets were distributed more evenly, and the proportion of infantrymen was increased. This was done by both detaching one armoured brigade to form another division, and by increasing the number of infantrymen so the division had a full brigade group of motorized infantry to complement its remaining armoured brigade group. Reflecting their use in mobile and armoured combat, these motorized infantry were armed with more and more powerful anti-tank weapons than their infantry counterparts.

(3) Infantry Tank Regiments and Brigades: For a good while called Army Tank Brigades, these units contained infantry tanks: slow, heavily armoured

monsters intended to support infantry units. Each regiment contained about 50, and three regiments comprised a brigade. Though slow and under-gunned, they were so well armoured that the Italians had virtually no defense against them. The Germans, however, found that they could use 88mm anti-aircraft guns against them with devastating effect, and so later models were made somewhat quicker. Even so, they were outdated by the battles of El Alamein.

(4) Light Tank Brigades: During Operation Crusader, the British divided their different types of armour into different brigades. One of these contained new American light tanks. After that battle, the British tended to mix their types more, but created a Light Armoured brigade of armoured cars and light tanks to patrol the southern part of the Alamein line. This unit gradually grew heavier, but at the time of Montgomery's attack it still contained a higher proportion of light tanks than other brigades.

(5) Cruiser and Medium Tank Brigades: During Crusader, two of the British armoured brigades contained so called cruiser tanks: fast, lightly armoured vehicles intended for cross country pursuit and tank-to-tank combat. The British cruisers proved under-armoured and under-gunned, and their speed was offset by their mechanical unreliability. While the best cruiser types were pretty well equal to contemporary German tanks, British fortunes improved markedly as they obtained American medium tanks, first the Grant and then the Sherman. These were more heavily armed and armoured, and were better mechanically, and they gave the British a superior weapon during the decisive struggle at Alamein.

(6) Dummy Units: In several instances the British created fake brigades to mislead Axis intelligence. These consisted of empty tents, mock emplacements, and spare vehicles carefully deployed to give the impression of life. In some cases at Alamein the deceptions were carried out with admirable cleverness and amazing thoroughness.

### 4. ARTILLERY UNITS

(1) Artillery units: These represent various special groupings of heavy artillery, generally for use in a siege. These units can bombard enemy units that are adjacent or 1 hex away. Bombardment is ordered like any other attack, but the artillery units will not suffer any losses. Artillery units are very weak defensively, however.

(2) Air units: These represent various size and composition airforce units that were dedicated to direct support of the ground forces. German planes were mainly JU 87s, the famous Stukas, while British units included Beaufighters, Kittyhawks, and specially armed Hurricanes. Italian units represent a fraction of the bombing forces available.

### 5. MINES

On both sides, mines came to play an increasingly important role as a defense against tanks. To some extent the effects of mines are factored into the defensive benefits of fortifications and the fortified formation, but in certain instances minefields were so extensive that they merit representation by themselves. In some cases these minefields contained only mines, but in other others they also included an elaborate system of outposts and ambushes. Note that the number of mines reported in the text display is an arbitrary value, and not the actual number of mines in place.

CODE DAY CARD	
DAY	CODE RESPONSE
8	VENICE
Italian 100mm Field Howitzer 100/17	

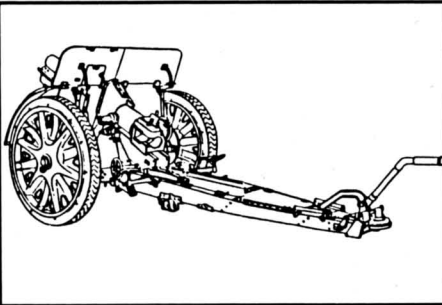

## 6. SUPPLY UNITS

In both the British and the Axis armies the combat units were but the tip of an iceberg of logistical, administrative, and other support units that stretched all the way from the battle zone to the home front. While it would be impractical to present this dimension of war in all its complexity, **DECISION IN THE DESERT** does include two types of headquarters that simulate the tremendous logistical tails that wagged each of these armies.

(1) **Headquarters:** These units represent the administrative and supply services that supported the units in the field. Their combat value is limited, and their main function is to act as conduits for supplies from more distant bases. They should thus be as well protected as possible, while being positioned to supply as many friendly pieces as they can.

(2) **Supply Depots:** These units represent the more distant bases even further back from the front than the headquarters. They have only limited ability to defend themselves, and move only very slowly if at all. Yet, because they are the ultimate source of supply for all the other units, without them, the rest of the army will soon wither and die. Protect them at all costs, particularly if you have only one. Note that in some scenarios these units are located "off map".

## D. EXPERIENCE

A unit's **EXPERIENCE** rating reflects the extent to which it has been trained for and involved in combat. During the game, particularly during the longer scenarios, units will advance in status as they gain combat experience.

1. **RAW:** The unit has had no combat training and no combat experience. Don't expect much from it.
2. **GREEN:** The unit has been trained, but has no prior experience. Green units will perform adequately under normal conditions, but cannot be expected to hold up under extreme pressure.
3. **VETERAN:** The unit has had prior experience in combat, and can be expected to perform well in all situations.
4. **CRACK:** The unit has had extensive combat experience, and has proved to be highly motivated and skilled in the techniques of war. A good unit to have in a tough situation.
5. **ELITE:** The unit has extensive combat experience, specialized training, and high esprit de corps. Expect it to perform far beyond its numbers.

## E. EFFECTIVENESS

A unit's **EFFECTIVENESS** rating reflects the extent to which the wear and tear of combat have reduced its ability to carry out its orders. Men, machines, and organization all lose effectiveness in combat, and must be given periods of inactivity to rest, repair, and reorganize. Units out of contact with the enemy will recover most rapidly. The levels of effectiveness are:

1. 100%: The unit is at its prime.
2. 90%: The unit has suffered a bit from the effects of combat, but is still in good shape.
3. 80%: The unit is beginning to feel the effects of prolonged combat.
4. 60-70%: The unit is definitely suffering from the effects of combat. It should be withdrawn if possible.
5. 40-50%: The unit is overstrained. It can be expected to deteriorate rapidly under pressure. It should be withdrawn as soon as possible.
6. 30% and less: The unit will offer little resistance to enemy attacks, and may disintegrate on its own. Withdraw it immediately.

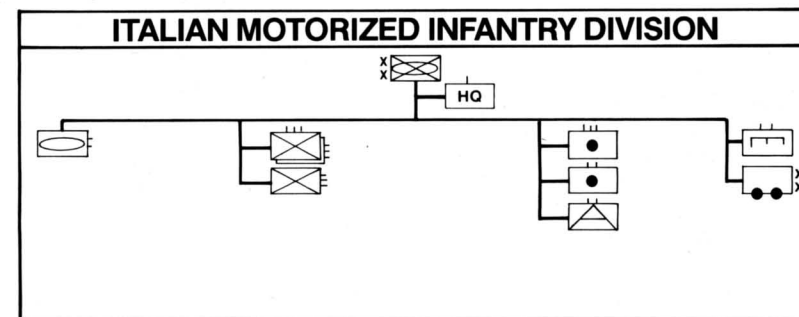

## F. COMMANDS AND MODES

1. **"MOVE":** A unit ordered to move will enter the movement mode in order to move rapidly to the objective assigned. It will select a formation which is best for rapid movement (note that this may leave it vulnerable to enemy attacks). When the unit reaches its objective, it will remain in formation prepared for further movement. A unit may be ordered into movement mode without assigning an objective in order to prepare it for rapid movement in case it is required to move.
2. **"ATTACK":** A unit ordered to attack will enter the offensive mode and deploy itself for an attack. If an objective has been assigned, the unit will move in a direct path to that objective, attacking any enemy units encountered along the way. Once the unit reaches its objective, or if no objective has been assigned, the unit will attack on its own initiative. A unit attacking on its own will attack the weakest enemy unit in its vicinity, support another unit's attack, or attempt to capture an enemy held objective. Attacks by ground units can only be made against adjacent enemy units; attacks by air units can be made against any enemy unit.
3. **"DEFEND":** A unit ordered to defend will enter the defensive mode in order to protect itself and to defend its objective. To accomplish this, it will select the most suitable terrain for defense, align itself with supporting units, and assume a strong defensive formation. A unit may also be assigned to defend a specific location.
4. **"RESERVE":** A unit ordered into reserve will enter the reserve mode, a general purpose rest formation in which it will most quickly absorb replacements and recover from fatigue. If the unit is not given an objective it will simply remain in place; if it is assigned one it will simply move to it.

## G. FORMATIONS

Units will automatically change formation based on their current mode and tactical situation. The possible formations are:

1. **MOBILE:** This is the most common formation for rapid movement. Tanks and mechanized vehicles are formed into road columns, infantry and artillery are mounted on their transport. This formation is poorly suited to attack or defense.

2. **DEPLOYED:** This is the standard offensive tactical formation. Tanks and infantry are formed into combined arms teams, artillery batteries are sited and prepared for fire. This formation is suitable for attack, defense, or movement.

3. **DEFENSE:** This formation represents one level of defensive preparation. It is similar to "deployed" but infantry has begun digging in, artillery batteries have been ranged on the most likely avenues of attack, and tanks have taken up concealed positions.

4. **ENTRENCHED/FORTIFIED:** These formations represent the second and third levels of defensive preparation. Deeper entrenchments have been dug, barbed wire and obstacles have been placed, and secondary defensive positions have been prepared.

5. **GARRISON:** In some scenarios certain units begin in this formation. They defend as if fortified, but cannot move until a date specified in the scenario's "special rules" section.

CODE DAY CARD	
DAY	CODE RESPONSE
9	HERCULES
<i>British Universal Carrier</i>	

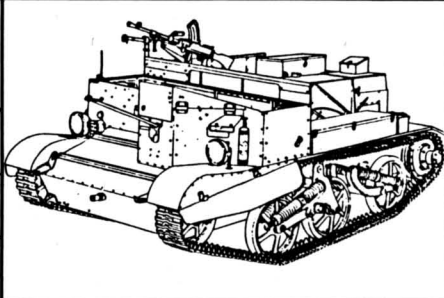

## H. SUPPLY

Supply is an essential consideration in both strategy and tactics. Many effective attacks involve destroying the enemy's source of supply or isolating his units. Each unit carries a limited amount of supplies with it, but deplete these rapidly if not resupplied. Each day at midnight the computer will automatically conduct the resupply routine, in which units may receive fresh supplies from a friendly supply source. Supply sources will distribute supplies to all units to which a line of supply can be traced, within the limit set by the side's overall supply total.

1. **OVERALL SUPPLY TOTALS:** Each side begins the game with a store of supplies set by the scenario. In addition, each side's total will be increased regularly to reflect the inflow of supplies into the theatre. On the other side of the balance sheet, supplies will be withdrawn daily from this total to resupply friendly units that are not isolated. The level of supplies in the overall supply totals are reported (on the status display at the end of the resupply routine).

The possible levels are:

- (1) **AMPLE:** Enough for several days of normal activity.
- (2) **SUFFICIENT:** Enough for more than a day of normal activity.
- (3) **CRITICAL:** Less than one day's reserve. Units will begin running out of supplies. This can only be rectified by husbanding your supplies to build up a surplus, basically by restricting your army's activities.

CODE DAY CARD	
DAY	CODE RESPONSE
10	ACROBAT
<i>Infantry tank Mark II (Matilda II)</i>	

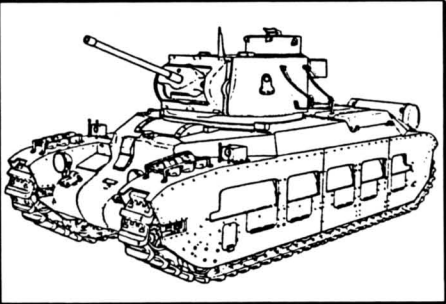

2. **SUPPLY SOURCES:** Two types of units serve as supply sources for combat units: headquarters and supply depots.

(1) **Depots:** Supply depots act as the points of origin for supplies, the places where they enter the map. Each depot can act as the source of an unlimited amount of supply. Depots can supply any other units. Depots can never become isolated.

(2) **Headquarters:** Headquarters can serve as a supply source for any unit except other headquarters. Headquarters can contain only a limited amount of supply, and must themselves trace a line of supply to a depot in order to receive additional supplies. A headquarters that is in supply, however, may supply any number of units within the limit set by the amount of supply available to the depot. A headquarters that is out of supply will continue to supply other units until it has used up its store of supplies.

3. **LINES OF SUPPLY:** In order to be resupplied, a unit must be able to trace a line of supply to a friendly headquarters or depot unit. Supply lines are traced by the most direct and easily traveled route. If a supply line can be traced, the unit receives supplies; if this path is blocked by an enemy unit, the supply line is interdicted. The computer will attempt to trace a line of supply for each unit from each supply source until one is found that is unblocked and within range (about 125 miles under normal conditions). If no such line of supply can be traced, the unit is isolated and cannot receive additional supplies.

4. **SUPPLY REQUIREMENTS:** Each combat unit requires a certain amount of supply simply to exist. In addition, movement, defense, and attack consume twice that amount, while movement and attack consumes three times as much.

5. **EFFECTS OF ISOLATION:** If a unit does not have sufficient supply its ability to attack, move, and defend itself is reduced. If a unit cannot meet its minimum daily requirement, it will lose effectiveness until it finally surrenders. Re-establishment of a supply line will gradually restore the unit's effectiveness.

## I. REINFORCEMENTS AND REPLACEMENTS

Depending on the scenario and variant, the British may receive new units during the course of play. In addition, units on both sides that are already in play may receive additional tanks to reflect replacements drawn from reserves and repairs to damaged equipment.

## J. TERRAIN

Each hex on the map contains a symbol which describes the dominant type of terrain in that area. Terrain affects movement, combat, and supply. The symbols are identified on the center color insert.

1. **DESERT:** represents an area of open desert, which was not a sea of sand dunes, but a hard, rocky surface with minor folds and undulations. This kind of



firm, open country was perfect for tank equipped units, and safe for infantry only if they were protected by a strong force of anti-tank guns.

2. **ROUGH:** represents an area of particularly broken country. These included areas with many rocky outcroppings and depressions, sudden drops in the desert floor. They offered some obstacles to the free movement of motor vehicles and some cover for dismounted units. Thus, rough terrain offered some slight advantages for the defender, especially for infantry.

3. **HILLS:** represent areas of pronounced undulation, which gave one side or the other the advantage of height for observation and the protection of a reverse slope. Units could hide behind the crest, and tanks could fire "hull down", which meant with only their turret showing. Like rough terrain, hills thus offer some advantage to the defender, although not as much as many foot soldiers would have liked.

4. **ESCARPMENT:** Unlike rough and hilly terrain, the escarpment formed a considerable barrier to armoured units. In some places, they were so steep that mechanized movement was impossible, while in others they merely made it very difficult. A defender gained the advantage of height against units approaching from below the slope, and of reverse slope against those coming from above. Furthermore, the limited number of places suitable for mechanized movement allowed the defender to concentrate his resources against the possible or most likely points of attack. All in all, the escarpments formed the desert's most hostile terrain to the armoured armies.

5. **PASSES:** represent relative breaks in the escarpment favorable for vehicular traffic. However, they were still fairly rough terrain, and so channalized traffic that they strongly favored the defense.

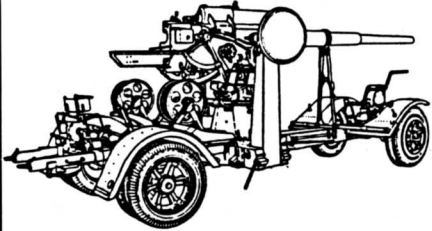
CODE DAY CARD		
DAY	CODE RESPONSE	
11	SUPPLY	
German 88mm flak gun		

6. **ROAD and TRACK:** represent the major routes for rapid movement. The coast road was actually a hard surface road, although the passage of so many heavy vehicles chewed it up pretty well. The tracks represent secondary roads that were not macadame, but were relatively well defined. Both enabled units to move particularly quickly, while having relatively little effect on combat.

7. **TOWNS:** In most cases, these contained only a few rude buildings, which did not figure very heavily on an operational level. Tobruk was about the only town of any size, and even it did not form a serious military obstacle. Because they had streets and tended to be on roads or important tracks, however, towns are particularly easy to move through.

8. **AIRPORTS:** Strategically, airports were important because they were the bases for both ground support aircraft and for the bombers and fighters that were battling for control of the Mediterranean sea to the north of the desert. Tactically, they offered particularly open and flat surfaces, plus connections to the network of roads and tracks, so they are good for mechanized units to move and attack on and lousy for infantry to defend on.

9. **COASTAL:** These areas are of two very different types. Those that are primarily land are treated as desert; those that are primarily water are treated as sea.

10. **SEA and HARBOR:** These areas are impassible to all units.

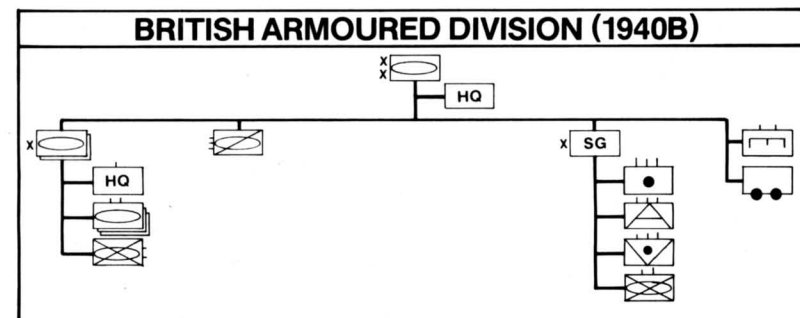

## K. WEATHER AND TIME OF DAY

Contrary to popular belief, the sun does not always shine on the desert. In fact, in the winter the soldiers suffered severely from a cold wind and a penetrating, chilly sleet. Even in the summer, a sudden shower could turn the desert floor into mud, hindering mechanized movement and grounding aircraft, whose fields were nothing but dirt. Possible weather conditions in order of severity are Clear, Showers, Overcast and Rain. The more severe the weather, the more difficult are movement and attacks. Air units are particularly affected by bad weather, and cannot fly at all during rain.

Movement and attack are also more difficult at night.

## L. MOVEMENT

### 1. EXECUTION OF MOVEMENT ORDERS

Whenever a unit is assigned an objective, it will commence moving towards that location. There are no restrictions on the distance between the unit and its objective. Units will select their own route to the objective, avoiding difficult terrain and moving around blocking units.

In general, you will find that this "built-in" intelligence greatly simplifies the entry of movement instructions. However, the longer the distance to be covered, the greater the likelihood that the unit will choose a route that, while initially attractive to it, turns out to require it to move through difficult terrain. To avoid this possibility, you should order a unit moving a long distance to move through a series of specific objectives by assigning these individually.

### 2. EFFECTS ON MOVEMENT RATES

A unit's rate of movement is affected by a number of factors.

(1) **UNIT TYPE:** Motorized units move significantly faster than other units, particularly in clear terrain and along roads. For specific unit types, see above, Part C.

(2) **FORMATION:** Units in mobile formations move quickly. Units in deployed and defense formations move slowly. See above, Part G.

(3) **TERRAIN:** In general, the more open the terrain, the quicker units can move. For details, see above, Part J.

(4) **WEATHER:** The worse the weather, the slower a unit can move.

# SUMMARY OF COMMANDS

(5) **LEADERSHIP:** Certain generals are better than others at moving their units. This effect is built in to the units.

(6) **OTHER UNITS:** A unit can never enter a hex occupied by another unit. In addition, units inhibit the movement of enemy units in adjacent hexes.

## M. COMBAT

### 1. EXECUTION OF ATTACK ORDERS

Whenever a unit is ordered to attack, it will attempt to engage an enemy unit, either one assigned by an objective order or one it chooses itself. Most units can only attack adjacent units. Air and artillery units can bombard enemy units. Combat can result in a number of effects on attacker and defender.

### 2. COMBAT EFFECTS

(1) **LOSSES:** Most combat causes both units to lose combat effectiveness and take casualties.

(2) **RETREATS:** If the attacking units are substantially stronger than the defending units, the defenders may be forced to retreat. Defenders whose routes of retreat contain other units or are adjacent to enemy units cannot retreat, and will suffer higher casualties instead.

(3) **ADVANCE AFTER COMBAT:** If the attackers are very strong, they may advance into a defeated defender's location.

(4) **OVERRUNS:** An overwhelming attack may "overrun" the defender, which causes it to be temporarily removed from the game.

(5) **ATTACKS CANCELLED OR CONTINUED:** If the defenders are too strong, the attacking unit will generally call off the attack. Otherwise, if the first attack does not achieve a decisive result, the attack will continue.

### 3. TACTICS

There are a number of techniques for performing a successful attack.

The simplest is to concentrate overwhelming forces against the defender; the more units are attacking, the weaker the defender will be against each attack. Unfortunately this tactic will frequently leave you vulnerable in other areas, and it is often impossible to get enough units close enough anyway. Furthermore, this sort of frontal attack will usually just push the defender back, rather than eliminating it altogether.

A second technique is to move one or more units around behind the enemy to surround it, or to find a weak spot in the enemy defenses and begin your attack there. A weak spot might be an isolated enemy unit, poor defensive terrain, or newly arrived units which have not yet dug in. Whether you get units behind the enemy by finding an open flank or punching a hole in the line, once there your units can attack the enemy from behind while other friendly units attack from the front. This approach enables you to get more units against each enemy unit, blocks in the retreat of defeated enemy units, and may cut their supply lines. In the last case, they will be easier to attack when they run out of supply or maneuver to restore their supply lines.

Defensively, five general principles apply. First, select an area with good defensive terrain and a secure supply line. Second, anchor your flanks on impassable terrain or a strong defensive position. Third, keep your units close enough together that enemy units cannot move between them, preferably close enough that an enemy unit that attempts to do so will come into contact with two units. Fourth, give your units time to enter a good defensive formation. Fifth, keep a couple strong, mobile units behind the lines, available to plug any holes in it. Simple, eh?

### 1. ACTION COMMANDS:

**"M"** (MOVE) Commands the unit under the cursor to prepare to move.

**"A"** (ATTACK) Commands the units under the cursor to attack an enemy unit.

**"D"** (DEFEND) Commands the unit under the cursor to entrench and defend itself.

**"R"** (RESERVE) Commands the unit under the cursor to enter the "Reserve Mode", in which it most readily recovers from losses.

**JOYSTICK ENTRY:** Move the cursor over the unit, push the trigger twice, move the arrow on the menu that appears in the text display, and press the trigger again when it is next to the desired command. Use "Cancel" to exit menu without changing the unit's orders.

### 2. OBJECTIVE COMMAND

**"H"** (HERE) Designates an objective for the last friendly unit accessed (via the keyboard commands "A", "D", "M", or "R", or the joystick driven command menu).

**JOYSTICK ENTRY:** This command can also be entered by pushing the trigger of the joystick when the cursor is over the desired location. If an enemy unit occupies it, the trigger must be pressed twice. If a friendly unit is in the objective location, the "H" command must be used.

### 3. INFORMATION COMMANDS

**"SPACE"** (UNIT STATUS) Displays all available information on the unit under the cursor. If the unit is an enemy unit, only limited information will be available. This information can also be gained via the joystick by pressing the trigger once.

**"C"** (CITY) Displays the name, occupant, and Victory Point value of the city under the cursor.

**"G"** (GENERAL) Describes the commander of the unit under the cursor. (Except Atari)

**"W"** (WHO?) Places the cursor on the unit from which the last message originated.

**"?"** (WHO'S WINNING?) Displays the game status in the text display area, including the current casualty levels, the victory level, and the current overall supply totals.

**"O"** (OVERVIEW MAP) Replaces the scrolling map and text display with a one screen map of the entire board area, showing land and sea areas and the deployments of the opposing armies. Press any key to return.

### 4. UTILITY COMMANDS

**"F"** (FREEZE) Freeze the game action; press "F" again to restart.

**"L"** (LOAD) Load a previously saved situation from disk. Atari and Commodore: enter the file name (1-8 characters), and press RETURN. Apple: enter the number of the game.

**"Q"** (QUIT) Used to change sides in a two player game.

**"B"** (FLASHBACK) Used to enter the flashback mode to review the course of the current game. (Except 64K Apples and Atari 800).

**"S"** (SAVE) Save the current game situation on disk. Atari and Commodore: enter a file name (1-8 characters), and press RETURN. Apple: enter number and file name (1-15 characters).

**"T"** (TERRAIN) Removes all units from the map and displays the terrain underneath. Press "T" again to restore the units.

**"U"** (UNITS) Changes unit display from symbols to icons and back.

**"<" and ">"** (Atari and Apple), **"+" and "-"** (Commodore) (SPEED INCREASE AND DECREASE) changes speed of play during the game.

# Decision in the Desert

COMMAND SERIES

FROM MICROPROSE SOFTWARE

© Copyright 1985

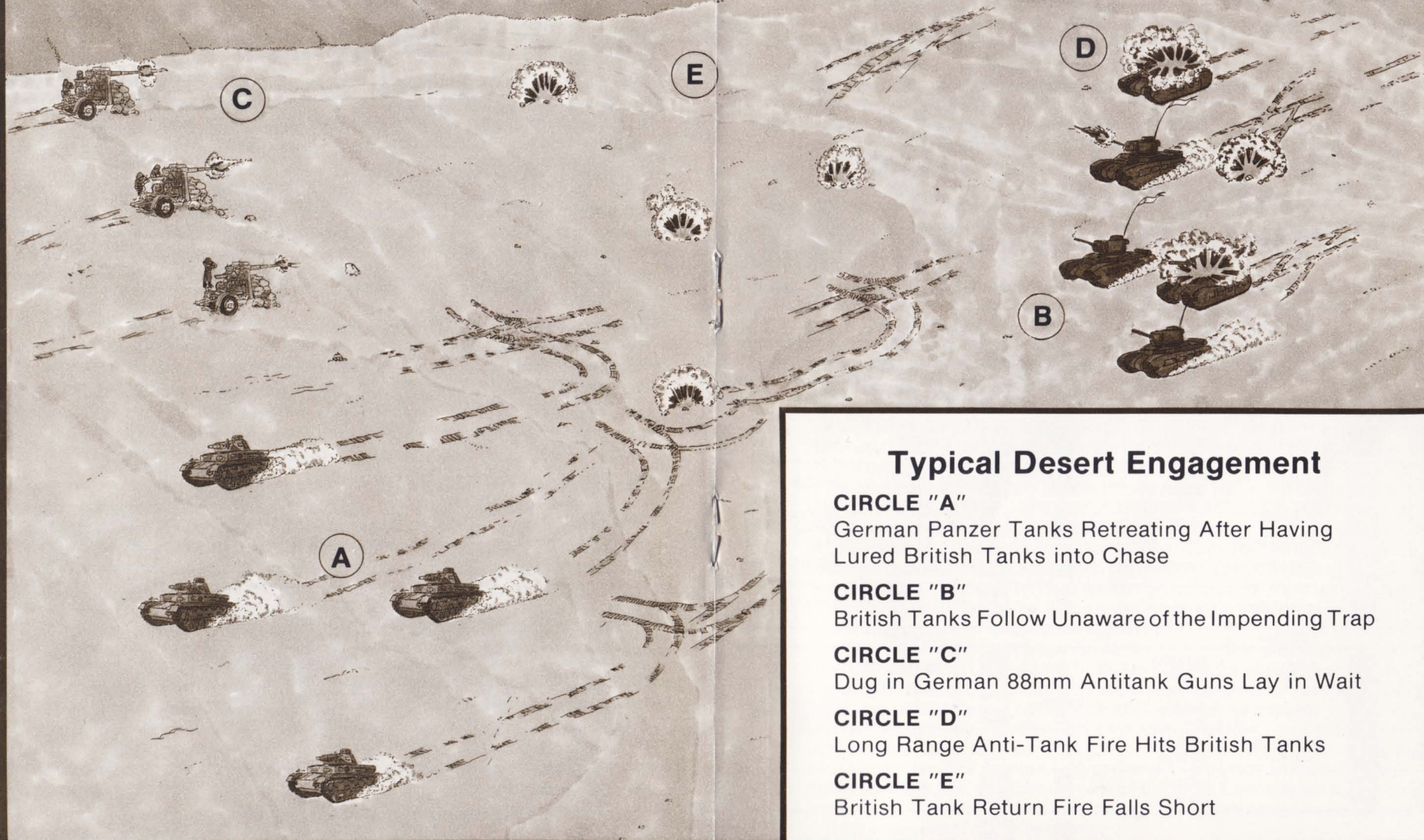

## Typical Desert Engagement

### CIRCLE "A"

German Panzer Tanks Retreating After Having Lured British Tanks into Chase

### CIRCLE "B"

British Tanks Follow Unaware of the Impending Trap

### CIRCLE "C"

Dug in German 88mm Antitank Guns Lay in Wait

### CIRCLE "D"

Long Range Anti-Tank Fire Hits British Tanks

### CIRCLE "E"

British Tank Return Fire Falls Short

# TERRAIN KEY

SCREEN PICTURE	NAME	COMBAT FAVORS	MOVEMENT EFFECTS
	SEA		IMPASS-ABLE
	COASTAL (WATER)		IMPASS-ABLE
	COASTAL (LAND)	NORMAL	NORMAL
	HARBOR		IMPASS-ABLE
	FORT	DEFENSE HEAVILY	NORMAL
	ROAD (Black) & TRACK (Red)	ARMOURED ATTACKS	FAST
	HILLS	DEFENSE	SLOW
	ROUGH	DEFENSE	SLOW
	DESERT	ARMOURED ATTACKS	NORMAL
	AIRFIELD	ARMOURED ATTACKS	NORMAL
	PASS	DEFENSE	SLOW
	ESCARP-MENT	DEFENSE	VERY SLOW
	TOWN	NORMAL	NORMAL

## UNIT TYPES

ICON	SYMBOL	TYPE	SIZE	VP
<b>ITALIAN</b>				
		BLACKSHIRT	DIVISION	1
		LIBYAN	DIVISION	1
		INFANTRY	DIVISION REGIMENT	2
		MOTORIZED INFANTRY	DIVISION	3
		ARMOURED	DIVISION	4
		PARACHUTE	DIVISION	5
<b>GERMAN</b>				
		INFANTRY	REGIMENT DIVISION	5
		PARACHUTE	BRIGADE	5
		MOTORIZED INFANTRY	REGIMENT DIVISION	6
		PANZER	REGIMENT DIVISION	7

## UNIT TYPES

ICON	SYMBOL	TYPE	SIZE	VP
<b>BRITISH</b>				
		INFANTRY	BRIGADE	3
		SUPPORT	GROUP	4
		MOTORIZED INFANTRY	BRIGADE	4
		INFANTRY TANKS	REGIMENT BRIGADE	7 4
		LIGHT ARMOURED	BRIGADE	4
		CRUISER/MEDIUM	BRIGADE	4
<b>COMMON</b>				
		ARTILLERY		5
		AIR	SQUADRON GROUP	7
		MINE FIELD		0
		HEADQUARTERS		12
		SUPPLY DEPOT		20

## N. EXAMPLE OF PLAY

As the Sidi Barrani scenario opens, the main British strike force, the 4th Indian and 7th Armoured divisions, have just completed an all-night march across the desert to their assembly area. On the coast, Selby Force has moved along the hard surface road in order to cover the direct route to the British base area of Matruh and to draw the Italian's attention away from the threat to their desert flank. The Italians, for their part, begin the game fortified in their camps, blissfully unaware that the long lull in the desert war is about to end.

Selby Force begins the battle close enough to the 1st Libyan division to establish contact with it, but it begins the game in DEFENSIVE formation so it will not be overwhelmed if the numerically superior Italians ATTACK. All the other British combat units begin with orders to ATTACK, and will seek out enemy units if left to their own devices. However, the British commander would be well advised to FREEZE the game and prepare the initial onslaught more carefully.

One possible opening is to order the two Indian infantry brigades to MOVE abreast to hexes adjacent to the 2nd Libyan Division in Tummar. From these hexes the Indians can then be ordered to ATTACK in concert (if they are simply ordered to ATTACK this unit from their starting positions, one is likely to arrive before the other and, ATTACKING unsupported in the dark, suffer a sharp setback). Meanwhile, the 7th Royal Tank Regiment should be ordered to MOVE along the southern perimeter of the Niebeiwa camp, while the 16th Infantry and 7th Armoured brigades and the 3rd RAAF aquadron are ordered to ATTACK that Italian stronghold. By the time they have moved adjacent, the 7th RTR should be in position, and can be ordered to ATTACK the Italian garrison from the rear.

While this central assault is being prepared, the 4th Armoured brigade should be ordered to MOVE to Bir Enba, where it can grab a few victory points and prevent any Italian units from moving against the flank of the main British force. The 7th Support Group should be ordered to MOVE without being given an objective, so that it will enter the MOBILE formation and thus be ready to MOVE rapidly wherever the need or opportunity is greatest.

The 2nd Libyan Division may offer stiff resistance to the Indian assault, but the Maletti Armoured Raggruppamento is unlikely to hold out for more than half a day. Once it has been beaten, the British commander must make the central decision of the battle: how to exploit this hole in the enemy line. While some forces should naturally pursue the retreating Italian armour and others may go to the aid of the Indians, one or two units will be free to go wherever the British commander chooses. Should they be used to reinforce the units attacking the Italian encampments to the north? Should they sweep wide across the desert just north of the escarpment to cut the coast road and strike toward Buq Buq? Or should they be routed south of the escarpment to reinforce the unit in Bir Enba, ATTACK the Italian division in Sofafi, and continue on in a wide sweep toward Halfaya pass and Sollum?

There is no right choice, but the decision you make will determine the character of the rest of the game. If you are playing the introductory variant you should remember that time is short and you must press forward audaciously to achieve victory. If you are playing one of the longer variants, do not be lulled into complacency by your easy initial victories. The terrain around Halfaya pass is difficult to attack through, your supply situation will begin to get tight, and you may well find your forces overextended and counterattacked by fresh Italian divisions. The short variant will teach you the mechanics of the system and some of the basics of strategic thinking; the longer ones will begin to teach you the subtleties of real generalship.

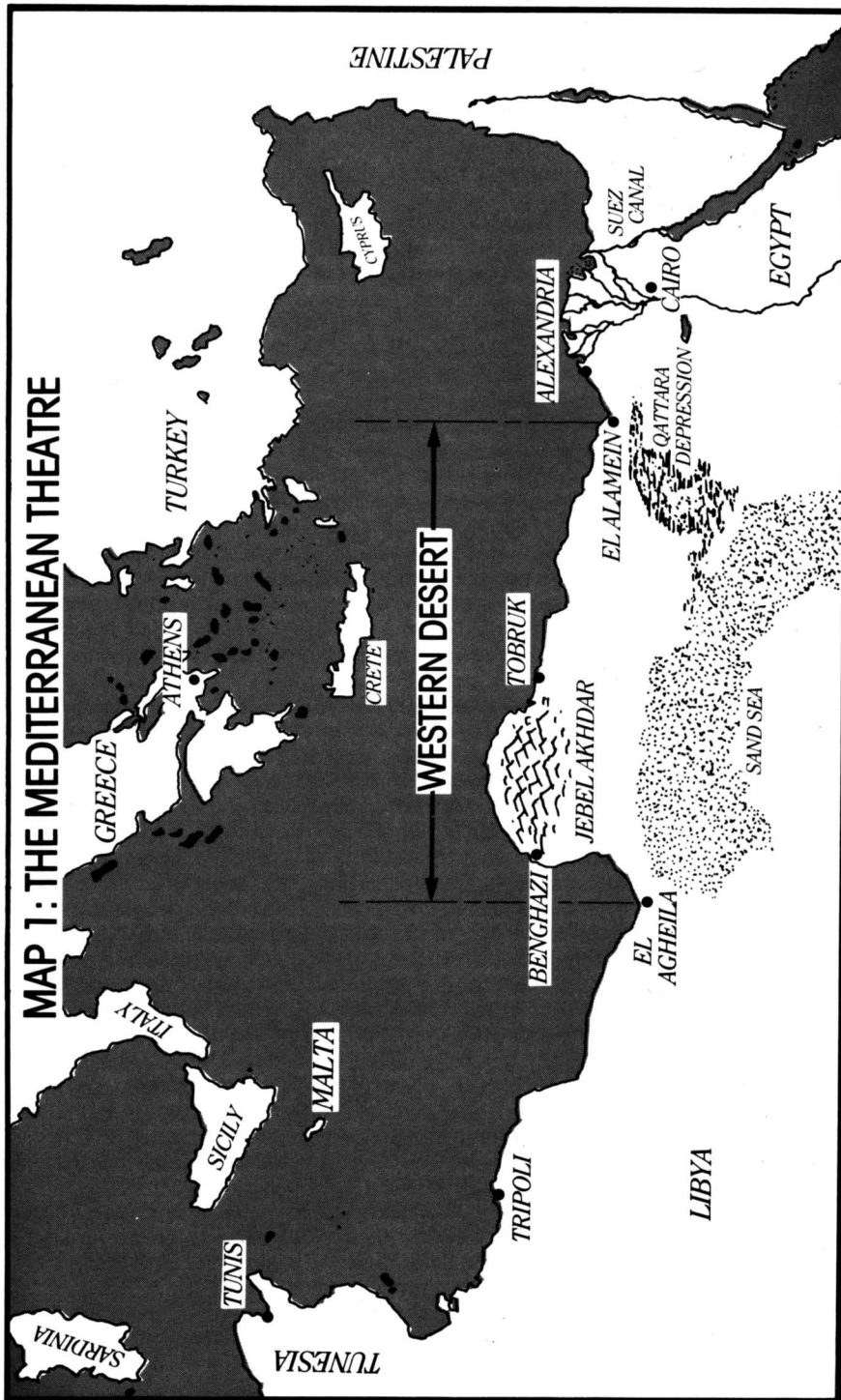

## Section IV - NOTES

### A. HISTORICAL NOTES

#### 1. INTRODUCTION

The North African Theatre of World War II was one of the pivotal campaigns in that epic struggle. It was here that Mussolini's dream of a new Roman Empire was put to the test of arms; it was here that Germany first lost the strategic initiative; and it was here that the British learned through bitter failure the techniques of war that enabled them triumph in the end.

For the Italians, North Africa was a vital link in Mussolini's grandiose plan to recreate the Roman Empire. To do so, they would have to drive the modern-day Carthaginians of Great Britain from the shores of the Mediterranean Sea. The heart of the British position was Egypt, so shortly after the beginning of the war Mussolini ordered his army in neighboring Libya to move across the frontier.

For the British, the defense of North Africa was both a means and an end. It was a means in that control of Egypt was essential for control of the Suez Canal, which was vital to control of the sea-lanes of the Mediterranean and thus access to the oil-fields of the Near East and the markets of India. The campaign was an end in itself in that North Africa was the closest place to Europe that the British could beat the Italians, and later the only place where they could trade blows on the ground with the Nazis. For a long while they got the worst of these exchanges more often than the best, but eventually they forged an army that formed the nucleus of the Allied Forces that defeated the fascist powers.

For the Germans, the North African campaign started as a holding action to protect the Italians from catastrophe. By 1942, though, the Nazi leadership saw in the Afrika Korps one arm of a pincer movement into the oil rich Near East, the second arm of which was to advance down from Southern Russia through the Caucasus Mountains. When this drive failed, the tide of the war turned. North Africa became a disaster that had to be staved off, even if this meant committing ever greater forces to a hopeless cause. Ironically, this last ditch defense cost numbers of men and tanks that would have been decisive had they been sent half a year earlier.

Despite these varying aims, all the combatants confronted the common problem of how to master the unique situation presented by the North African desert. On the one hand, the environment was harsh and lines of supply were long and vulnerable. On the other hand, the vast open tracts favored a war of rapid maneuver by mechanized forces. First the British and then the Germans discovered an unparalleled opportunity for mobile warfare. Thus, North Africa served as a crucible, testing men, machines, and commanders at the limits of their endurance.

CODE DAY CARD	
DAY	CODE RESPONSE
12	MARIE
40mm A-A gun (Bofors)	

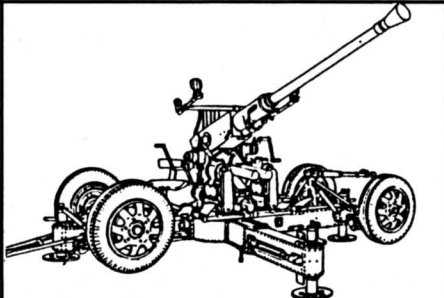

The campaign itself can be broadly subdivided into five sections: the Italian Campaign, Rommel's First Offensive, Operation Crusader, Rommel's Second Offensive, and the climactic battles at El Alamein. The span of conflict stretched from September of 1940 to January of 1943, and in that time the entire direction of the War changed. Churchill summarized the enormous influence of this theatre with his somewhat exaggerated statement that "before El Alamein we never won a battle; after El Alamein, we never lost a battle."

CODE DAY CARD	
DAY	CODE RESPONSE
13	LUSTRE
Cruiser tank Mark I (A9)	

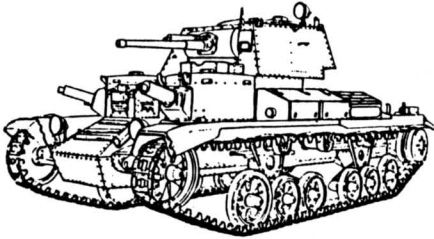

## 2. THE ITALIAN CAMPAIGN

On June 10, 1940, Italian dictator Benito Mussolini declared war on Great Britain, eager to share in the spoils of an anticipated Axis victory. His forces in Africa controlled Italian East Africa, Libya, Eritrea, and Abyssinia (Ethiopia). In Libya, Marshall Graziano commanded over 200,000 troops, a force that far outnumbered the British in neighboring Egypt. Mussolini's army, however, was painfully slow to act. Problems maintaining control over newly-conquered Ethiopia and the notorious Italian inefficiency combined to delay any forceful thrust into British-held territory until September.

The British raided energetically from the beginning of the war, but they too were ill prepared for the conflict. Their closest base to the frontier lay 120 miles to the east at Mersa Matruh, which was itself some 200 miles west of the Nile Delta. Their "Western Desert Force" comprised only about 35,000 men under General Richard O'Connor, and its equipment was in short supply and of uneven quality. Separated from an Italian force outnumbering them over four times by only a stretch of desert, the British had reason to view the situation as grim.

Once the Italians had reached Sidi Baranni, though, they inexplicably halted. After they had remained inactive there for nearly three months, O'Connor decided to move. On December 9, after a daring all-night march, the British force of one armoured division and one infantry division attacked. Supported by a regiment of heavy "Matilda" infantry tanks, the British punched through the Italian lines, captured one fortified camp after another, and reduced the intrusive Italian force to a panic-stricken rabble. In less than a week, the British had eliminated any Italian presence in Egypt and captured over 35,000 prisoners.

It was an auspicious beginning that portended further successes. However, to O'Connor's chagrin the immediate response of the British High Command was to recall the 4th Indian Infantry Division for redeployment to the Sudan. Nevertheless, the 7th Armoured Division chased the Italians into Libya, where it was soon joined by the first elements of the 6th Australian Division. On January 3, 1941, the advance began again, with an attack on the Italian stronghold of Bardia. The Italians folded within two days under the

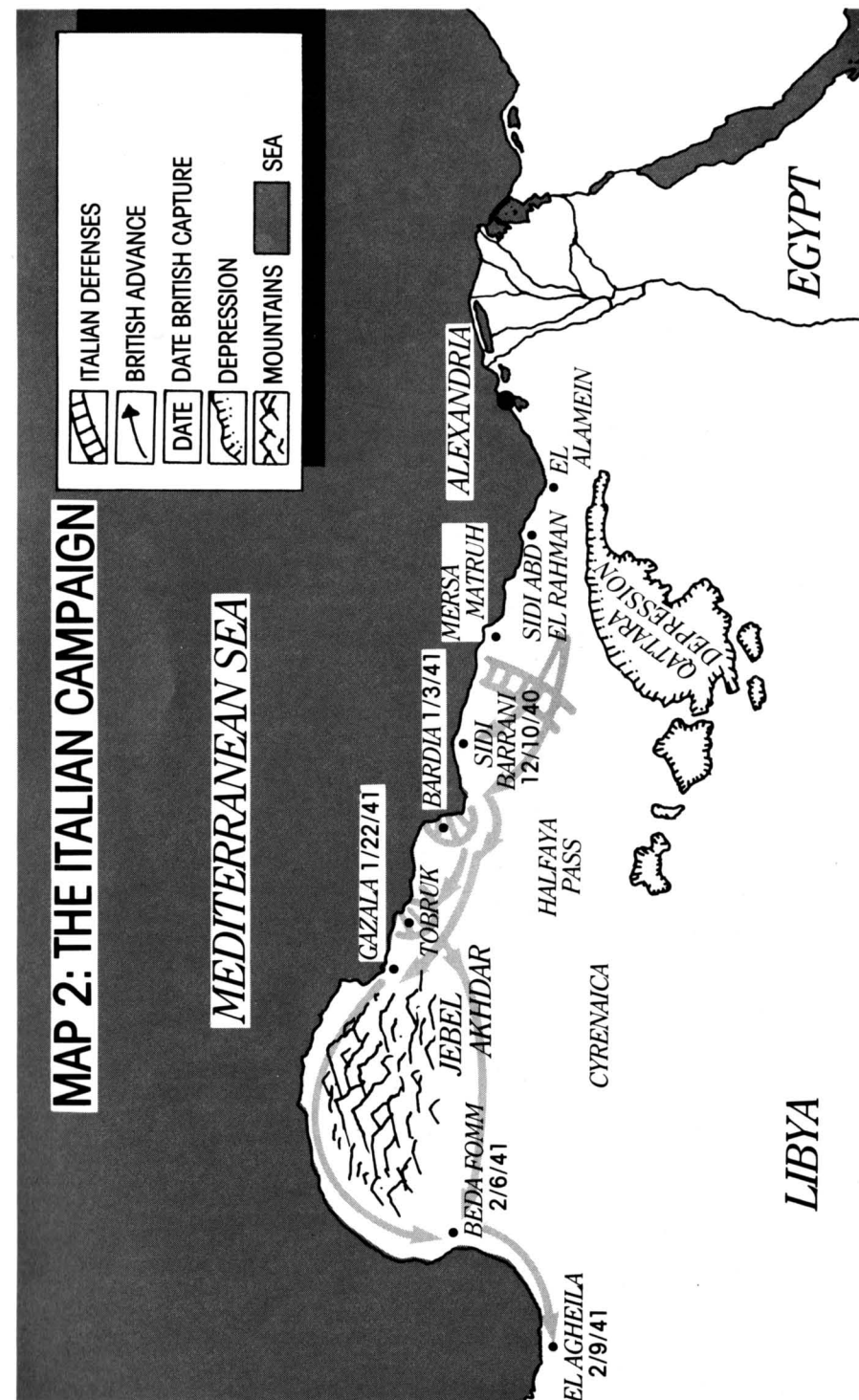

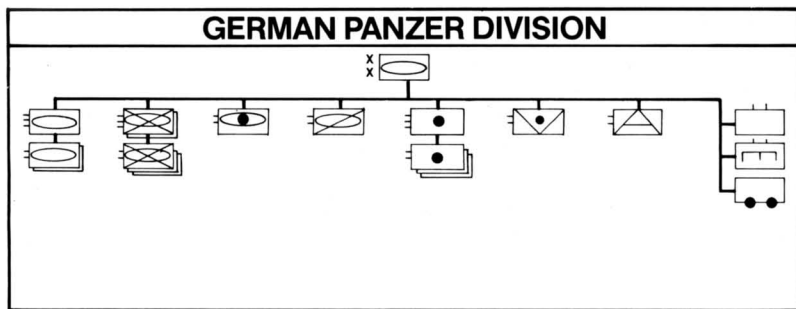

Australians' energetic assault, and the war swept on to the vital harbor of Tobruk. Here the Italians were even less well prepared, and the British took it without trouble. Their armoured units cut across the desert while the infantry chased the retreating enemy along the coast road, until the armour caught them at Beda Fomm. After a feeble break-out attempt on February 7, General "Electric Whiskers" Berganzoli unconditionally surrendered his remaining forces.

### 3. ROMMEL'S FIRST OFFENSIVE

In two months, the British under O'Connor had advanced 500 miles, destroyed nine Italian divisions, and captured more than 100,000 men, 400 tanks, and 1,000 guns. O'Connor wanted to press on relentlessly, but most of his experienced units were withdrawn and sent to Greece, where the Germans were intervening to help the hapless Italians, who had invaded and then been humiliated. The Western Desert front was thinly manned by inexperienced units deployed more as a garrison than a field defense force.

Unfortunately for the British, the Germans decided to bolster their ally in North Africa as well. They sent first the 5th Light division and soon thereafter the 15th Panzer division. To lead this expeditionary force the Nazi high command selected General Erwin Rommel, a choice which was to have far-reaching consequences for the subsequent course of the campaign.

Rommel quickly recognized the weakness of the British position and, disobeying explicit orders, launched his first offensive on March 24 of 1941. His strategy involved a panzer thrust around the British desert flank while two Italian infantry divisions advanced along the coast road. The results of this first encounter were decisive: the Germans drove the British back towards the Egyptian frontier, and in the process they utterly destroyed the 2nd Armoured Division. Worse still, an Axis motorized detail surprised and captured O'Connor.

Only the 9th Australian Division reached the relative safety of Tobruk, where the Axis troops invested it. They first tried to take the fortress by storm, but instead of an easy victory their assaults were repulsed bloodily. Rommel had no other choice but to entrench his forces and begin a siege. This undertaking was difficult because of the length of his supply lines, and it was ultimately hopeless because he could not cut the defenders off from resupply by sea.

In late April Rommel's Afrika Korps attacked again, and the minor gains of this assault, combined with German advances along the frontier, resulted in the resumption of mobile warfare that Rommel so eagerly sought. Wavell, the British theatre commander, realized that no relief effort could be undertaken without retaking the strategic Halfaya pass near the border, so on May 15 a small group of tanks and infantry under Brigadier Gott launched Operation Brevity. After some initial British successes, the operation ended with little

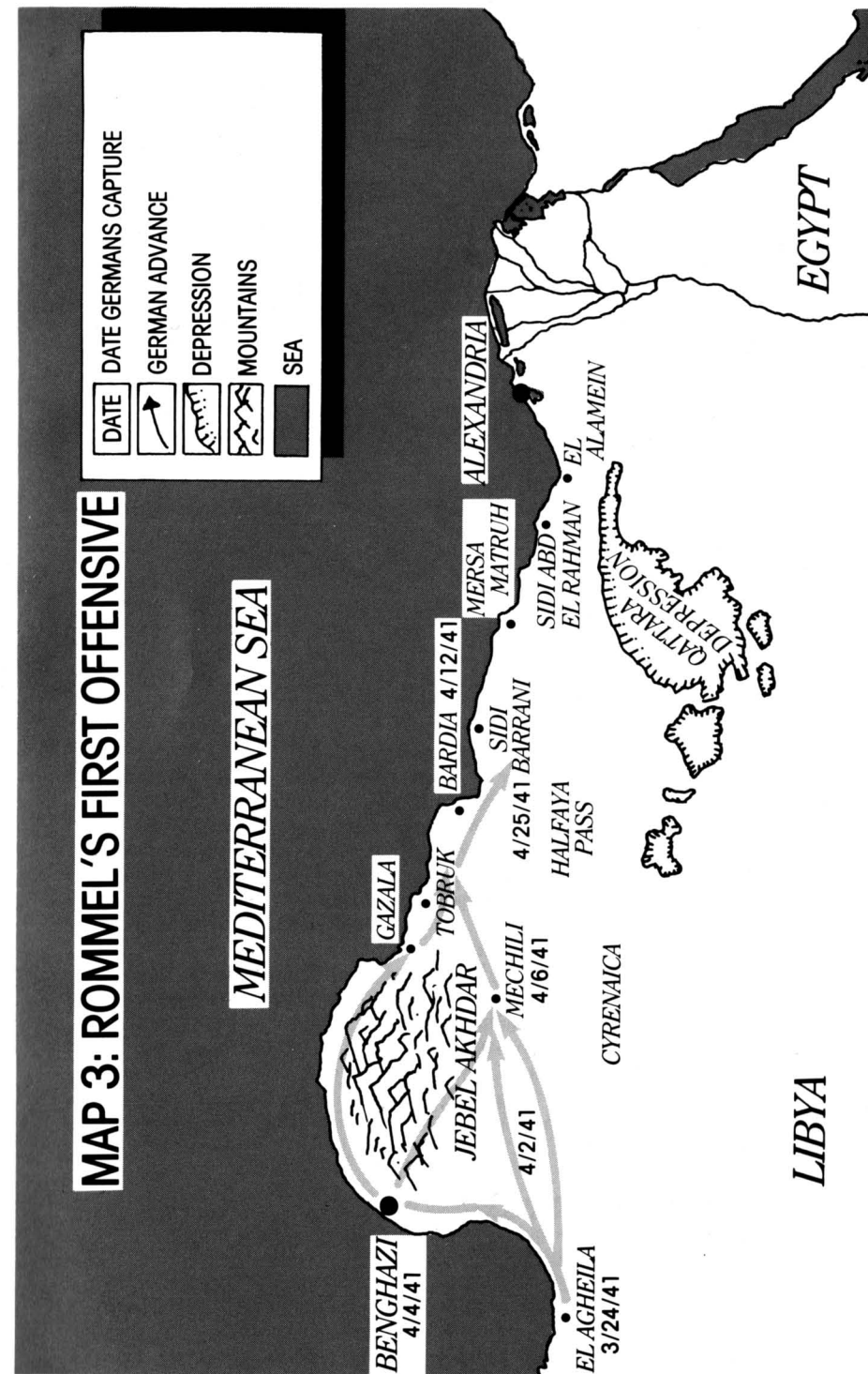





The British position consisted of a line some forty miles long, heavily fortified, stretching from Gazala on the coast to Bir Hacheim, to the south. Holding the line were the brigades of two infantry divisions and an independent brigade of Free French. Behind the line the Eighth Army deployed two armoured divisions and a number of independent infantry formations. Tobruk, 30 miles to the east, was garrisoned by a further infantry division.

On May 28, Rommel shattered the uneasy calm. After diversionary attacks by the Italians and a detachment of Germans along the north of the line, the Afrika Korps' two panzer divisions, the 90th Light Division, and the Italian armoured division swung wide to the south to sweep into the rear of the British position. This the mobile forces did easily, but once they were there they found themselves trapped between the extensive minefields and dug in defenders of the Gazala line and the still unbeaten British armour.

Rommel drew his divisions together into a defensive circle within the British lines known as the "Cauldron." To the west, Italian troops advanced through the minefields toward the beleaguered Germans, while to the south German and Italian units fought to reduce the French stronghold at Bir Hacheim. For several days the Afrika Korps was effectively cut off, but fortunately for Rommel, the British command proved unable to launch a quick attack. His armoured divisions were able to hold out until the Italians cleared a passage for supplies. Thus renewed, the Afrika Korps defeated piecemeal British attacks, and on June 11 broke out of the Cauldron, overran the French at Bir Hacheim, and wheeled back north toward the coast. This move threatened to cut off the Allied Infantry holding the northern end of the Gazala line, and so Ritchie reluctantly ordered them to retreat.

At this juncture, Auchinleck again assumed direct command, hoping to shore up the British position in order to save Tobruk. However, the fortifications had been neglected since the end of the siege, and on June 21 the defenders buckled beneath a massive onslaught by Axis air and ground forces. With those British units not trapped in Tobruk retreating deep into Egypt, British fortunes approached their nadir.

## 6. EL ALAMEIN

At this point, with his enemies vanquished as never before, Rommel was faced with the most momentous strategic decision of the campaign. His original orders were to defeat the British at Gazala and seize Tobruk, and then halt while the German and Italian air forces concentrated on an airborne assault against Malta. This fortress island lay athwart the Axis lines of supply across the Mediterranean Sea, and its planes and small vessels played havoc with Axis shipping. For an advance into Egypt to have a firm logistical base, the Axis had to seize Malta.

Instead of following this plan, however, Rommel plunged across the border, sending mobile columns in a wide arc to the south of the coast in order to cut off the retreating British. Wearing captured British clothing, eating captured British rations, riding in captured British trucks, and in some cases supported by captured British artillery, Rommel's forces swept eastwards, drawn by dreams of the Nile Valley and the Suez Canal. The Afrika Korps almost caught the British at Mersa Matruh, but they slipped through a gap in the encircling Axis lines and retreated back to prepared positions at El Alamein.

Rommel's advanced units arrived at Alamein in the last days of June, almost the same time as the British, but when Rommel tried to bull his way through, his exhausted troops were stymied and repulsed. The panzers were unable to best the British defenses inland, while the infantrymen of the 90th Light division met a wall of artillery pieces that decimated them. Pinned down by the defenders, subjected to an ever increasing harassment from the air,

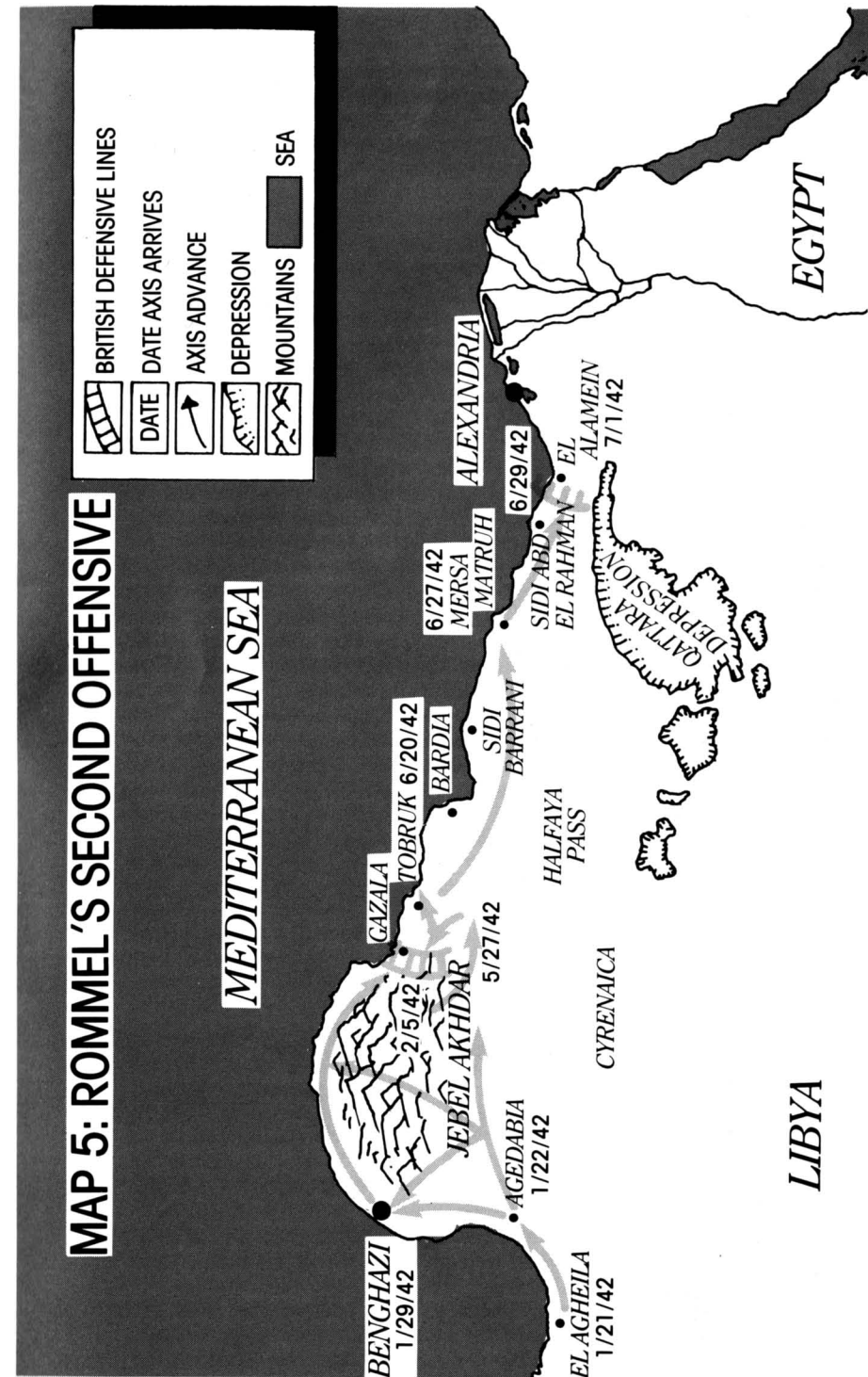

and exhausted by weeks of campaigning, the men of the Afrika Korps had reached the limits of their endurance. As the attacks known as the First Battle of Alamein fizzled out, Rommel switched his forces to the defensive.

July saw a series of British attacks as Auchinleck strove to wear the Axis forces down by a series of short sharp blows. He was never able to gain much ground, but neither was Rommel with his occasional counterattacks. The fighting gradually drained both sides, and died down by the end of the month. August was quiet, as each army strove to repair its wounds and replenish its reserves. On the British side, a new team of leaders was brought in: Sir Harold Alexander became commander in chief of the theatre, and General Bernard L. Montgomery took command of the Eighth Army.

The most important feature of the Alamein position was that it was impossible to sweep around the enemy's southern flank, for about fifty miles inland lay the Qattara Depression, a vast expanse of marshy, broken country that was all but impassable to large forces. As August wore on, Rommel could see that he was slowly losing the logistical race, and so he resolved to attack before the disparity had become insurmountable. Even though his own supply level was far below his own estimate of the minimum necessary, he launched his attack on August 31. Swinging his armoured forces as far inland as he could, Rommel planned to turn the British flank and drive north to cut off the units forming the line. Once the Alamein line was cracked, there was no natural line of defense between the Panzerarmee and the Nile Delta.

From the beginning, the battle did not develop as Rommel had hoped. Six thousand tons of fuel Rommel needed to maintain his assault now resided on the bottom of Tobruk's harbor. The British effectively screened their lines from German reconnaissance, so he had only a vague notion of the positions against which the army would advance. Aerial reconnaissance proved impossible in the face of Britain's growing superiority in the air, and when the battle started the British air forces began to hound the attackers mercilessly. Shaken and demoralized by the incessant air attacks, the panzers and motorized infantry advanced deep into the British left flank, but then ran up against a lateral line of defense based on the Alam el Halfa Ridge, from which the battle got its name. The British armour refused to be lured into a careless charge, and instead it was the German armour which found itself compelled to attack.

CODE DAY CARD	
DAY	CODE RESPONSE
14	SPLICE
Cruiser tank Mark VI (Crusader)	

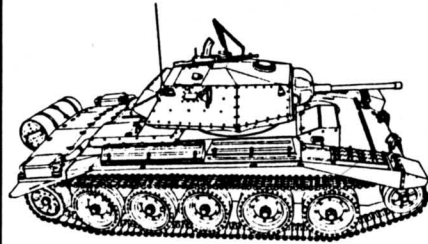

The British had been receiving ever greater numbers of improved anti-tank guns and powerful new American medium tanks, so the German panzers met the same fate that the British had when roles were reversed. After only three days Rommel could tell that the attack had failed, and ordered his forces to withdraw. The British were slow to pursue, and the Germans were able to pull back successfully. Several days of bitter fighting ensued as the British

attempted to press home their advantage, but this effort achieved little. Nevertheless, Montgomery had achieved his objective: he had blunted Rommel's last best effort. Improved weapons and tactics and clear, firm thinking at the top had brought the Eighth Army the victory its morale desperately needed.

Montgomery insisted on taking his time before he launched his own offensive. He knew that his forces needed time to train, and by October they came to outnumber the Axis by nearly two times in infantry, tanks, and artillery. Finally, on October 23, 1941, at 9:40PM, one thousand British guns opened fire on a six-mile stretch of the Axis' left, near the sea. At 10:00, Montgomery's XXXth Corps attacked, with the XIIIth Corps providing a diversionary effort on the Southern end of the lines. Advancing under the light of a brilliant full moon, the infantry divisions of the XXXth Corps cleared a path through the extensive German minefields. Their job was to open a hole in the Axis defensive line through which could pass the tanks of the newly formed X Corps.

Progress was extremely slow, however, as Axis infantry, guns, and tanks grimly fought every step of the advance. When Montgomery struck, Rommel was in Germany on sick leave, but on October 25 he returned to reassume personal command. The following day, Montgomery shifted all of his attention to the north, calling off the attack on the southern end of the German position. In a series of shifting attacks, the British slowly advanced through the defenses, finally forcing the German panzers to charge against dug in anti-tank guns. On the northern flank the 9th Australian Division steadily pushed the 164th German Light Division into the Sea. The Eighth Army was grinding the Axis forces away through the disciplined application of overwhelming force.

On November 1, Rommel depleted the last of his armour reserves, extricating the 164th Light Division. Nearing the end of their supplies, the Axis forces had only 35 tanks left. On November 3, Rommel ordered his troops to retreat, but was forced to revoke the order by Hitler, who typically called for a stand to the last man. The next day, though, a British assault broke through German lines, and Rommel began a retreat that was to continue out of Egypt, across Libya, and into Tunisia before, in early February, it came to a halt. Montgomery moved too slowly to cut the Axis forces off, but he maintained a relentless pressure that kept Rommel from ever regaining the initiative.

Once in Tunisia, the Afrika Korps linked up with reinforcements brought over to counter the Allied landings in Morocco and Algeria the previous November. Much bitter fighting remained as the two allied armies slowly squeezed the Axis forces in Tunisia, until they finally collapsed in early May. Over a quarter of a million Axis soldiers surrendered, and Allied control of North Africa was secure. From here their armies would cross first to Sicily and then to Italy, and knock that foe out of the war. In these and the later campaigns in France and Germany, all Allied armies would benefit from the lessons about modern mechanized warfare that the desert soldiers had learned so painfully in the wasteland of North Africa.

## B. RECOMMENDED READINGS

World War II is one of the most popular topics for works of history. Literally thousands of volumes covering subjects ranging from the entire course of the war to the histories of small units and individual battles have been written, and more appear each year. The bibliography that follows is divided between works that provide a good introduction to the battles and campaigns covered by this game and works that provide detailed information for those who wish to delve more deeply. Neither of these lists is meant to be exhaustive; they are offered rather as an introduction for the interested gamer who would like to learn more about the events simulated in DECISION IN THE DESERT.

## 1. GENERAL READING

*Atlas of the Second World War*, ed. Peter Young; full of maps and photographs with a fairly extensive text accompanying.

Paul Carrell, *The Foxes of the Desert*; a German history-as-experienced-by-numerous-participants by a master of the genre.

Michael Carver, *El Alamein*; an unremarkable account of the battle.

B. H. Liddell Hart, *History of the Second World War*; an informative and entertaining history of the whole war by an early theorist of armoured warfare.

Wolf Heckman, *Rommel's War In Africa*; another history-as-experienced-by-numerous-participants, well done, and with an iconoclastic slant on Rommel's generalship.

Ronald Lewin, *Rommel As Military Commander*; a good study of the famous general's military career, with the bulk devoted to North Africa.

K. J. Macksey, *Africa Korps*; a good, short account of the campaign from the German intervention to the end in Tunisia.

K. J. Macksey, *Beda Fomm: The Classic Victory*; a good, short account of the campaign from the beginning of the war to the end of O'Connor's offensive.

Alan Moorehead, *The March to Tunis*; a lengthy journalistic account of the entire campaign.

James W. Stock, *Tobruk: The Siege*, a detailed study of the siege, singularly devoid of maps.

Desmond Young, *Rommel, the Desert Fox*; the standard biography, old but still useful.

May-June, 1970.

Albert A. Nofi, "North Africa: The Africa Korps," in *Strategy & Tactics*, Sept.-Oct., 1970.

Richard Dinardo, "The Armored Fist: Development of the Armored Division in World War II," *Strategy & Tactics*, Special Edition no. 4, 1984.

James F. Dunnigan, "Campaign Analysis Eastfront: Organization of German Ground Forces," in *Strategy & Tactics*, Jan.-Feb., 1971; contains much organizational information pertinent to the North African campaign.

Albert A. Nofi, "The Desert Fox: Rommel's Campaign for North Africa, April 1941-December 1942," *Strategy & Tactics*, July-Aug., 1981.

CODE DAY CARD	
DAY	CODE RESPONSE
15	STYLE
Panzerkampfwagen IV (Ausführung C)	

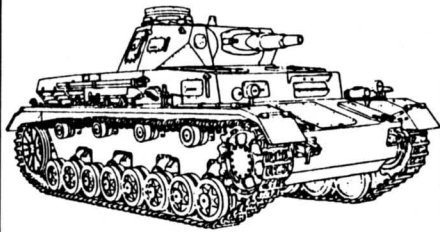

## 2. TECHNICAL REFERENCES

While the above list contains works appropriate for the casual reader, the following are more specific works for gamers interested in detailed information and technical data.

Chaz Bowyer & Christopher Shores, *Desert Air Force at War*.

Barrie Pitt, *The Crucible of War*, 2 vol; a detailed history of the entire campaign, with emphasis on El Alamein; contains a number of inaccuracies but overall very useful.

I. S. O. Playfair, *The Mediterranean and the Middle East*, vol. I-IV; the British Official history.

Christopher Shores, *Ground Attack Aircraft of World War II*; contains useful sections on North Africa.

Albert A. Nofi, "North Africa: The Italian Army," in *Strategy & Tactics*, Nov.-Dec., 1969.

Albert A. Nofi, "North Africa: The British Army," in *Strategy & Tactics*,

CODE DAY CARD	
DAY	CODE RESPONSE
16	PEDESTAL
Medium tank M3 (General Grant)	

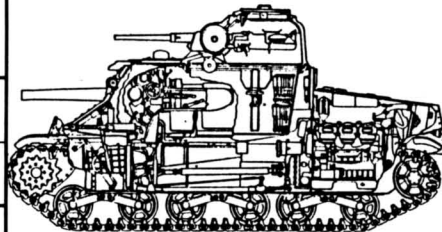

## Part V – SCENARIOS

Information on the scenarios is given in the following format:

A. INTRODUCTION: Gives background information about the scenario and variants to set the scene. For the full historical context see the Historical Notes, Section IV, Part A.

B. SCENARIO INFORMATION: Includes starting time and date, initial supply levels, overall rates or resupply, and replacement rates.

C. VARIANTS: Lists the variants and their ending dates if these vary.

D. REINFORCEMENT SCHEDULES: Gives the dates, times, and locations of arrival for units which enter the game during the course of play. Note that some units' arrival date is not definite, but only probable, starting on the date given. Units will not enter play as long as their hex of entry is occupied by another unit. All units are divisions unless otherwise indicated.

E. VICTORY CONDITIONS: Gives the Victory Point totals needed for the side on the offensive to gain a marginal victory and specifies the number of "critical locations" necessary for an automatic decisive victory. Totals greater than the minimum will lead to higher levels of victory; totals less than the goal constitute a victory for the defending side. This section includes a map showing the geographical sources of victory points in the scenario (note that Victory Points may also be gained for inflicting losses on the enemy).

F. SPECIAL RULES: Gives details on any features of play specific to the scenario.

### 1. SIDI BARRANI: BRITISH BLITZ

#### A. INTRODUCTION

At dawn on December 9, 1940, British troops under General Richard O'Connor struck the first substantial blow of the North African campaign. Following an all night march across the desert, they surrounded and assaulted the fortified camps set up by the Italians after their desultory advance into

Egypt. Most of the Italians resisted only feebly; those that showed more determination were overwhelmed. In three days the British force shattered an army four times its size and chased it back across the border.

Forced to pause by the withdrawal of most of his infantry, O'Connor resumed the advance just after New Year with an assault by the newly arrived 6th Australian division on the fortified port of Bardia. After a sharp but successful fight there, he shifted his troops to Tobruk, which was taken easily on January 22. The Italian 10th Army fled along the coast toward Tripoli, but the British moved across country to cut them off at Beda Fomm. Trapped, the Italian army collapsed entirely.

**SIDI BARRANI: BRITISH BLITZ** simulates the opening phases of the campaign to the fall of Tobruk. The first variant, "Battle of the Camps," recreates the opening British moves, which were originally to be no more than a "five day raid." It is a short game designed as an introduction to the system. The second variant, "Aussies at Bardia," extends from the opening of the battle to the day Bardia fell, while the third, "Drive on Tobruk," carries the challenge all the way to the fall of that crucial city. In all variants, as in reality, the British are favored, but victory is by no means certain for them, and a skillful Italian player can do considerably better than the actual Italian high command.

## B. SCENARIO INFORMATION

Start: 5 a.m., December 9, 1940

Initial Supply:

BRITISH: Sufficient  
ITALIAN: Ample

Resupply Rates:

BRITISH: Critical until 12/23, then sufficient.  
ITALIAN: Sufficient

Replacement Rates:

BRITISH: Each unit receives up to 20 tanks every two weeks.  
ITALIAN: Each unit receives up to 2 tanks every two weeks.

## C. VARIANTS

Variant 1; Introduction: Battle of the Camps; ends 6 p.m. December 11, 1940.

Variant 2; Aussies at Bardia; ends 6 p.m. January 3, 1941.

Variant 3; Drive on Tobruk; ends 6 p.m. January 22, 1941.

## D. REINFORCEMENT SCHEDULE

BRITISH: On 12/17 at Midnight the British 13th Corps artillery arrives on the east edge of the board.

ITALIAN: NONE

## E. VICTORY CONDITIONS

Variant 1: The British goal is to capture the Italian forts and coastal towns in Egypt, while destroying as much of the Italian army as possible. To win, they must gain at least 100 Victory Points.

Variant 2: The British need to accomplish all of the above objectives and drive on into Libya to Bardia, capturing towns and eliminating units worth at least 230 points. They win automatically if they capture Bardia or Tobruk.

Variant 3: Same as variant 2, except that the British must gain at least 300 points, and win automatically only if they capture BOTH Bardia AND Tobruk.

## SCENARIO 1: SIDI BARANNI

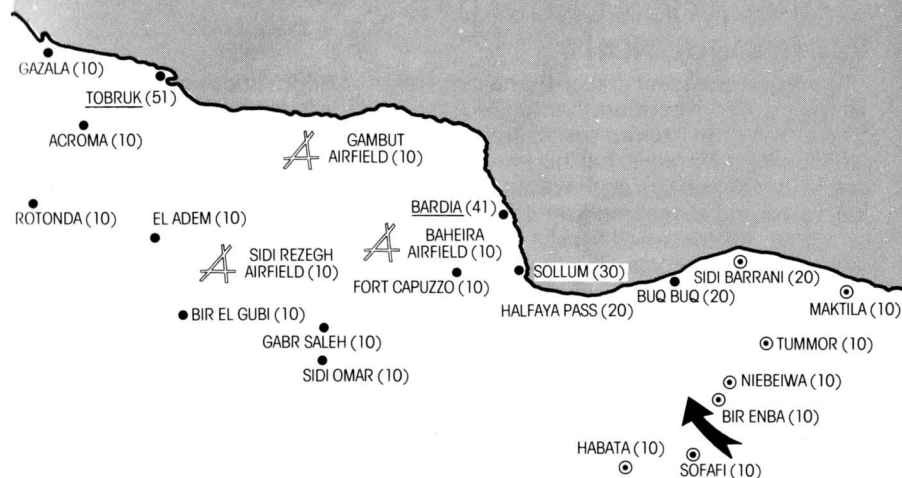

(#)	VICTORY POINT VALUE
	AIRFIELD
	ITALIAN FORWARD POSITIONS
	AXIS OF BRITISH ATTACK
NAME	CRITICAL LOCATION
	SEA

## F. SPECIAL RULES

1. To reflect the sluggish reactions of the Italian command structure, Italian units in FORTIFIED formation cannot move on the first day.

2. In the campaign, the 4th Indian division was withdrawn by the Theatre commander for redeployment to the Sudan. In the game, no units are withdrawn, but from December 12 until December 24 British infantry have their combat power reduced. Furthermore, they will not recover effectiveness lost through movement or combat. Consequently, the British commander is advised to withdraw them from contact with the enemy.

3. The dive-bombers of the 3rd Royal Australian Air Force squadron provided direct ground support during the initial weeks of the offensive, but it was withdrawn in late December. Thereafter, the only direct support the ground forces got were occasional strafing attacks by fighters. To reflect this change, on December 27 the combat power of the 3rd RAAF squadron drops dramatically, and stays low for the rest of the game.

4. The Tobruk and Bardia garrison units can only move into fortification hexes.

## 2. OPERATION CRUSADER

### A. INTRODUCTION

Having been sent to keep the Italian position in North Africa from collapsing entirely, Rommel more than fulfilled his mission with a lightning stroke that drove the British back across the frontier. However, their tenacious defense of Tobruk forced him to halt his forward movement, and their build-up along the border forced him on the defensive. Axis troops threw back their first offensives, but after a long period of preparation the British launched a massive attack around the desert flank. A month-long battle ensued. In the event, the British prevailed, but as the armies maneuvered and counter-maneuvered, attacked and counter-attacked, their fortunes fluctuated wildly.

OPERATION CRUSADER simulates this far-flung battle. Variant 1, "The Historical Situation," challenges you with the situation as it existed during the first two weeks. Can you wrest the initiative and win the battle by maneuver, or will it come down to a battle of attrition, as it did in history? Variant 2, "Rommel Strikes First," presents a plausible alternative: what if Rommel had completed his preparations to storm Tobruk first, and the British offensive had been, as he at first believed, merely a spoiling attack? To really make the game interesting, play the Germans and let someone else pick the variant secretly. In head to head play, let the British choose. Remember, the German can check up on the play balance setting it at the end of the game!

### B. SCENARIO INFORMATION

Start: 6 a.m., November 19, 1941

End: 6 p.m., December 7, 1941

Initial Supply:

BRITISH: Ample

AXIS: Ample

Resupply:

BRITISH: Sufficient

AXIS: Sufficient

Replacements:

BRITISH: Each British unit receives up to 24 new tanks every two weeks as replacements.

AXIS: None

## SCENARIO 2: OPERATION CRUSADER

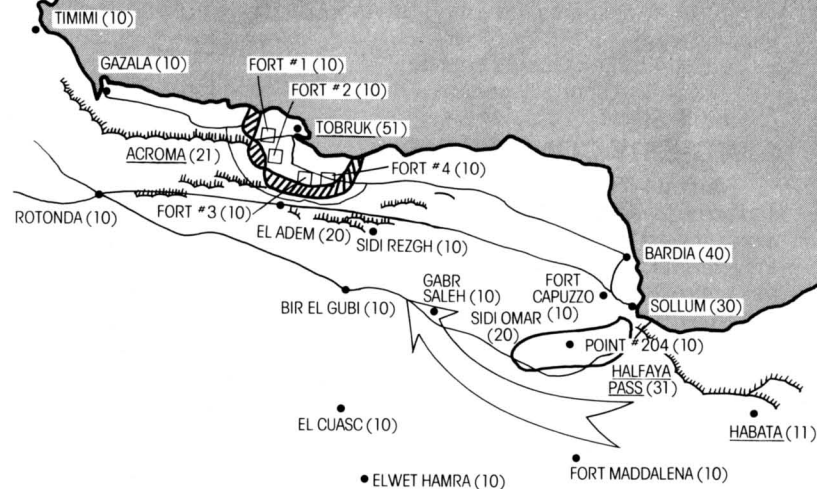

	ESCARPMENT		TOBRUK PERIMETER
	ROAD		AXIS OF BRITISH ADVANCE
	VICTORY POINT VALUE		AXIS FRONTIER DEFENSES
	CRITICAL LOCATION		TOBRUK FORTIFICATION
	SEA		

## C. VARIANTS

1. The Historical Situation
2. Rommel Strikes First

## D. REINFORCEMENT SCHEDULE

BRITISH: In both scenarios, the 2nd South African division will arrive on the east edge of the map on the coast road in the following order:

- 12/30/40, 3rd South African brigade
- 1/1/41, 4th South African brigade
- 2/1/41, 6th South African brigade

In the second variant only, the following British units arrive on the east edge of the map during the course of the battle:

- 12/19/40, 4th New Zealand brigade
- 12/22/40, 22nd Armoured brigade

12/23/40 or shortly thereafter, 7th Armoured brigade (on the track rather than the road)

- 12/24/40, 22nd Guards brigade
- 12/25/40 or shortly thereafter, 7th Support Group (on the track)

AXIS: NONE

## E. VICTORY CONDITIONS

Variant 1: The British are attempting to push the Axis back from the frontier and go on to relieve the garrison at Tobruk. To do so, they must capture towns worth at least 30 victory points and inflict greater casualties on the Axis than the Axis inflicts on them. The Axis can win an automatic victory by capturing one critical location; the British can by capturing two.

Variant 2: In this variant the Germans have the initiative, and can use it to secure a quick victory by taking Tobruk. Otherwise, they will end up in the same position they did historically. However, they must gain at least 10 victory points.

## F. SPECIAL RULES

1. British units in garrison formation in Tobruk are frozen until November 28.
2. Axis units in garrison formation are frozen for the entire game.

## 3. GAZALA: ROMMEL'S FINEST HOUR

### A. INTRODUCTION

Driven back to his starting point by Operation Crusader, Rommel did not wait long to turn the tables on the British. In late January he launched a second lightning offensive which swept the British back to a line less than fifty miles west of Tobruk. Here, however, the British dug in, and the two armies faced off for over three months. Rommel built up his forces for an offensive; the British created a chain of elaborate defenses between Gazala and Bir Hacheim.

Finally, at the end of May, Rommel struck. Swinging south of the southernmost of the fortified "boxes," the Axis mobile forces broke into the British rear. Instead of neatly trapping the British, though, Rommel's divisions found themselves caught behind the unbroken defenses. For several days the issue hung in the balance, and it was only the ineptitude of the British high command that enabled the Germans to survive until the Italian infantry cleared a path through the minefields.

GAZALA: ROMMEL'S FINEST HOUR enables you to relive this tense battle. Variant 1, "The Cauldron," is a relatively short game that recreates the first crucial week of the battle. "To Tobruk!" Variant 2, simulates the whole battle, from the first German advance at the end of May to the fall of the British bastion in late June.

## SCENARIO 3: GAZALA

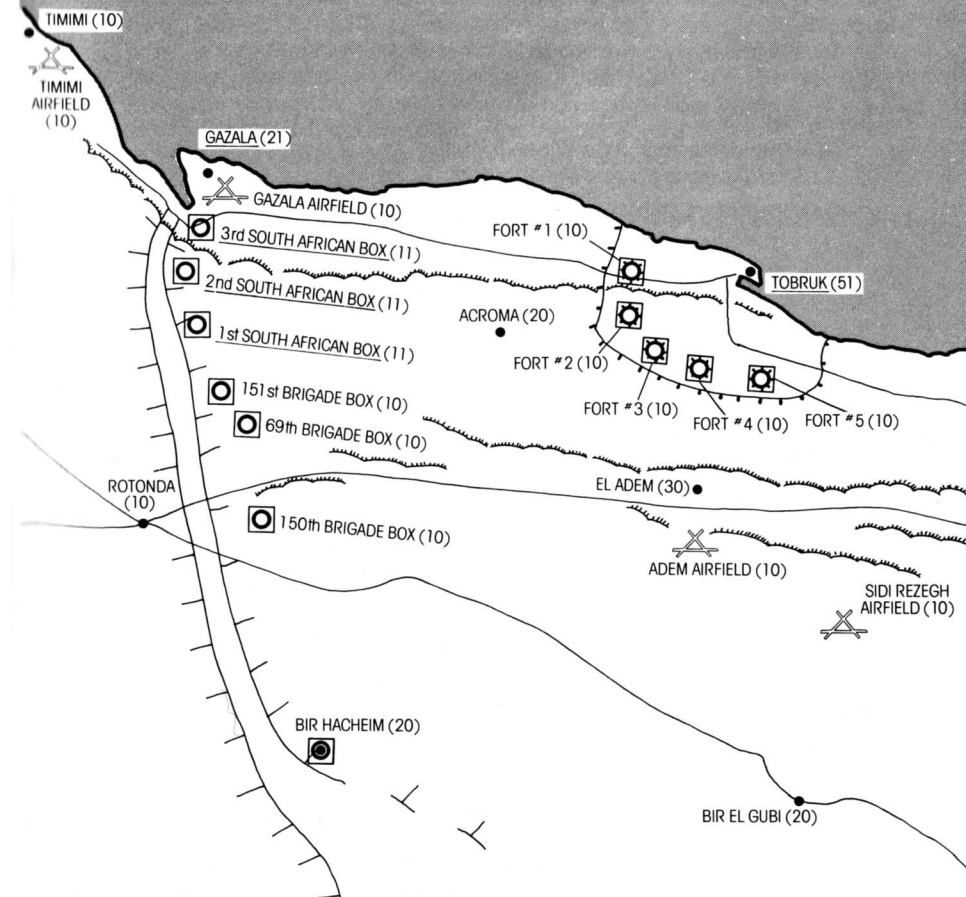

	BRITISH FRONT LINES, MAY 27		CRITICAL LOCATION
	GERMAN FRONT LINES, MAY 27		ESCARPMENT
	VICTORY POINT VALUE		FORT
	BRITISH STRONGPOINT ("BOX")		SEA
	TOBRUK PERIMETER		AIRFIELD
	ROAD		

## B. SCENARIO INFORMATION

Start: 7 a.m., May 27, 1942

Initial Supply:            Resupply Rates:  
BRITISH: Ample            BRITISH: Ample  
AXIS: Ample                AXIS: Sufficient

Replacement Rates:

BRITISH: Each unit receives up to 24 tanks as replacements every two weeks

AXIS: Each unit receives up to 16 tanks as replacements every two weeks

## C. VARIANTS

1. The Cauldron; ends 6 p.m. June 3, 1942
2. To Tobruk!; ends 6 p.m. June 20, 1942

## D. REINFORCEMENT SCHEDULE

BRITISH: The following units arrive on the east edge of the map on the date indicated or shortly thereafter:

6/3, 10th Indian brigade and the 1st Armoured brigade  
6/8, 11th Indian brigade  
6/11, 20th Indian brigade

AXIS: NONE

## E. VICTORY CONDITIONS

Variant 1: The German goal is to break through the left flank of the British fortified line. To do so, they must gain at least 50 Victory Points, usually by taking Bir Hacheim and the 150th Brigade Box and destroying two minefields and a few British brigades. However, they can also try a wider sweep to El Adem and Bir El Gubi. The Germans win an automatic decisive victory if they capture Gazala, the three South African boxes, and Tobruk.

Variant 2: The German goal is to crush the British defense. To win, they must gain at least 200 Victory Points. In general, they can do this by either clearing the Gazala line or punching through it and seizing (and holding!) Tobruk, and destroying a lot of British units in the process. The Germans win an automatic decisive victory if they capture Gazala, the three South African boxes, and Tobruk.

## F. SPECIAL RULES

1. Because of the inefficiency of British command structures, as the battle began their reserves were slow to react. To simulate this, British units that start the game in Defense formation cannot move until the beginning of the second day, May 28.

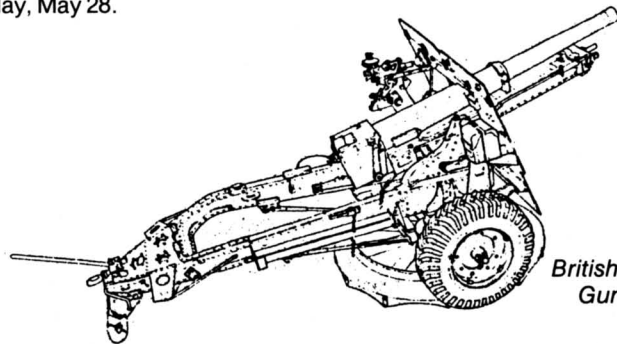

British 25-pounder  
Gun Howitzer

## 4. FIRST ALAMEIN: END OF THE BEGINNING

### A. INTRODUCTION

After his stunning triumph at Gazala, Rommel made the most critical decision of the campaign. Instead of halting so that the Axis forces in the Mediterranean theatre could concentrate on seizing Malta, he chose to drive deep into Egypt, hoping that the impetus of his victory would carry him to the Nile. Unfortunately, between his army and his objective lay a natural choke point, between the Qattara depression and the Sea. Here, the British could construct a defense whose flank could not be turned, and which lay within a few score miles of their Egyptian base. Rommel drove his men mercilessly to charge through the British defenders before they could coalesce, and he almost succeeded. His lead units arrived in the vicinity of El Alamein at the same time as the retreating remnants of his defeated enemy, and before fresh units rushed from Egypt had a chance to fully dig in. Halting only for a day to organize his forces, on July 1st he threw them into a frontal assault on the British position that strained them beyond the breaking point. Forced on the defensive, he spent the next month desperately staving off a series of British offensives until mutual exhaustion forced the belligerents into an uneasy stalemate.

FIRST ALAMEIN simulates this desperate lunge by the Afrika Korps and the bitter battles which followed it. Variant 1, "Lunge for the Nile," is a short game concentrating on Rommel's offensive. Variant 2, "Stroke and Counter-stroke," extends all the way to the end of July, when the British, too, were too exhausted to continue their attacks. Both variants present an extremely fluid situation in which two exhausted combatants strain to the limit to overcome the other's resistance. This contest was the last of the great mobile desert battles; from here on in the fighting would be dominated by the Allies' methodical application of their ever-growing material superiority.

### B. SCENARIO INFORMATION

Start: 3 a.m., July 1, 1942

Initial Supply:  
BRITISH: Sufficient  
AXIS: Critical

Resupply Rates:  
BRITISH: Sufficient  
AXIS: Sufficient

Replacement Rates:  
BRITISH: Each unit receives up to 800 men and 30 tanks as replacements every two weeks  
AXIS: Each unit receives up to 300 men and 20 tanks every two weeks

### C. VARIANTS

1. Lunge for the Nile; ends 6 p.m. July 7, 1942
2. Stroke and Counter-stroke; ends 6 p.m. July 30, 1942

### D. REINFORCEMENT SCHEDULE

BRITISH: The following units arrive along the road on the east edge of the map on or about the dates indicated:

7/3, 20th Australian brigade  
7/3, 24th Australian brigade  
7/3, 26th Australian brigade  
7/13, 5th Indian brigade

## SCENARIO 4: FIRST ALAMEIN

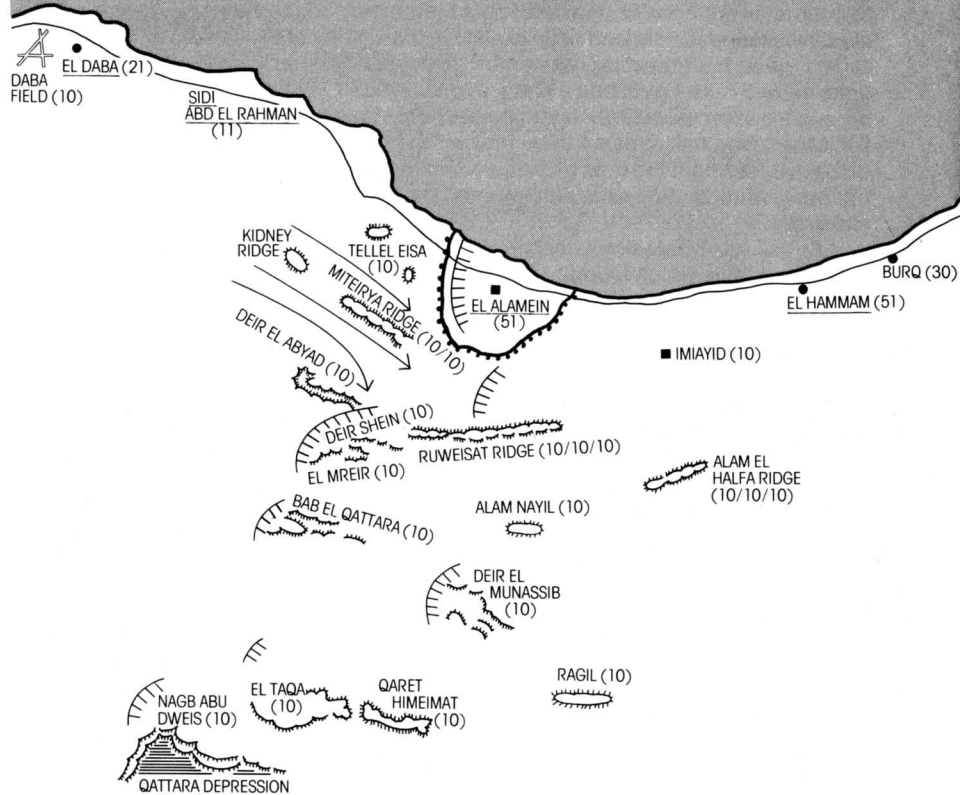

	AXIS OF GERMAN ATTACK		CRITICAL LOCATION
	BRITISH DEFENSIVE POSITION		RIDGE OR DEPRESSION
	VICTORY POINT VALUE		ROAD
	VICTORY POINT VALUE OF EACH HEX OF MULTI-HEX OBJECTIVE		ALAMEIN DEFENSES
	AIRFIELD		SEA

7/16, 23rd Armoured brigade  
7/16, 161st Indian brigade  
7/23, 69th Infantry brigade

The following unit appears on the track on the east edge of the map on or about the date indicated:

7/8, 2nd Armoured brigade

AXIS: The following units appear in El Daba on or about the dates indicated:

7/9, 382nd Panzergrenadier regiment

7/12, 125th Panzergrenadier regiment

7/15, 433rd Panzergrenadier regiment

7/21, Folgore Parachute division

7/24, Ramcke Parachute brigade

### E. VICTORY CONDITIONS

Variant 1: This scenario recreates Rommel's desperate attempt to break through the British defenses before they had a chance to consolidate. To win, the Germans must gain at least 140 Victory Points through some combination of capturing significant terrain features and inflicting losses on the British. The Germans win an automatic decisive victory if they capture both El Alamein and El Hammam. The British win an automatic decisive victory if they capture both Sidi abd el Rahman and El Daba.

Variant 2: This scenario simulates the series of battles which raged through July as the fortunes of war swung back and forth. The victory conditions are the same as in variant 1.

### F. SPECIAL RULES

1. To reflect the disorganization of the British at the beginning of the battle, their units that begin in fortified formation cannot move during the first day.  
2. To reflect the growing strength of defensive positions during the battle, the defensive value of the fortified formation increases gradually over the course of the month.

3. During the middle of July, the British 4th Armoured brigade was withdrawn from combat, issued armoured cars and light tanks, and rechristened the 4th Light Armoured brigade. To simulate this, the unit will attempt to disengage starting July 9th, and its combat value will drop precipitously on the 12th. It will regain strength on the 21st, and will regain its aggressiveness on the 22nd.

## 5. ALAM EL HALFA: BEGINNING OF THE END

### A. INTRODUCTION

As July drew to a close, the fighting sputtered out as both sides stood exhausted in about the same positions they had occupied after the first few days of battle. August was a time for replenishment and reinforcement on both sides. However, Rommel's supply lines were stretched to the utmost: ships and planes from Malta took their toll of every convoy that crossed the Mediterranean, and the Allied airforces harried the supply columns once they began the long, arduous journey from the ports in Libya. On the other side, the British were close to their base in the Nile delta, and while the journey from Britain by sea was lengthy, it was relatively secure. And most importantly, the British were beginning to enjoy the wealth of high quality war material produced in America.

Locked in an unwinnable logistical race, Rommel chose to strike at the end of August, before he was totally outmatched. ALAM EL HALFA simulates this last desperate assault. Variant 1, "Monty's Debut," presents the situation



## SCENARIO 5: ALAM HALFA

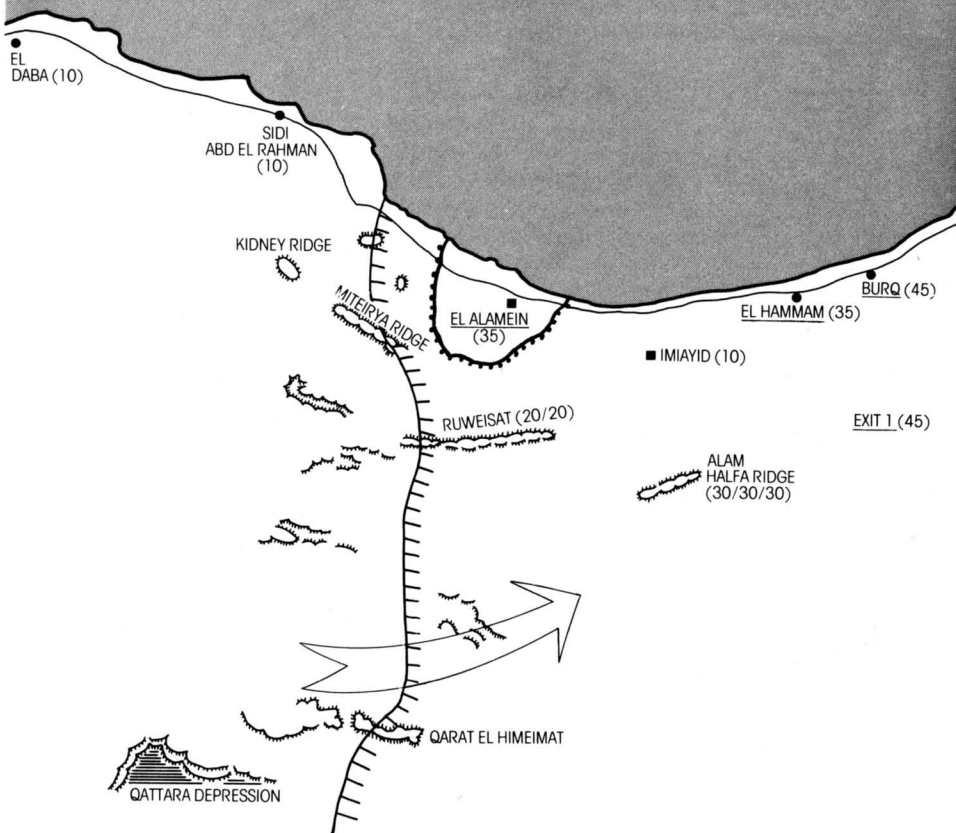

	BRITISH FRONT LINES AUGUST 30, 1942		CRITICAL LOCATION
	AXIS OF GERMAN ATTACK		PERIMETER OF EL ALAMEIN DEFENSES
	VICTORY POINT VALUE		RIDGE
	VICTORY POINT VALUE OF EACH HEX IN 9 MULTI-HEX OBJECTIVE		ROAD
			SEA

as it actually was: virtually hopeless for the Germans because of insufficient supplies. Their only chance is to lure the British out of their prepared positions and into foolhardy attacks. It had worked before, but will it work now that Montgomery is in command? Variant 2, "Rommel's Dream," presents the situation as Rommel would have liked it to be. His units are closer to full strength, and each carries considerably more supply. Furthermore, the British are free to attempt a battle of maneuver, which still would almost certainly favor the German. But it is important to remember that this scenario presents only a dream. If the First Alamein gives a last taste of the first half of the war, ALAM HALFA gives a first taste of the second.

### B. SCENARIO INFORMATION

Start: 1 a.m., August 30, 1942

End: Depends on Variant

Initial Supply:

BRITISH: Ample

AXIS: Critical

Resupply Rates:

BRITISH: Sufficient

AXIS: Critical

Replacement Rates:

BRITISH: Each unit receives up to 20 tanks every two weeks

AXIS: Each unit receives up to 16 tanks every two weeks

### C. VARIANTS

1. Historical Situation; ends 6 p.m., September 6, 1942

2. Rommel's Hope; ends September 13, 1942

### D. REINFORCEMENT SCHEDULE

BRITISH: The 69th Infantry brigade arrives on the east side of the board on September 2nd.

AXIS: NONE

### E. VICTORY CONDITIONS

Variant 1: Rommel's plan was to once again drive deep across the British southern flank in order to encircle them and take them from the rear. To block such a move, Montgomery created a lateral line of defense based on the Alam el Halfa ridge. Given the logistical situation, Rommel's plan was virtually doomed to failure. Nevertheless, if the Axis forces could inflict heavy casualties on the British, they could at least forestall disaster, and if they could capture some of the significant terrain, they would put the whole British line in jeopardy. Therefore, the Germans can win by gaining at least 5 Victory Points more than the British, and they win a decisive victory if they capture any two of the four critical locations (see map).

Variant 2: In this variant, the German objective remains the same, but the means of achieving it are increased. Therefore, the Germans must gain at least 120 Victory Points in order to win, and they win an automatic decisive victory only if they capture three of the critical locations (see map).

### F. SPECIAL RULES

1. To simulate the revised, more defensive British tactics and Montgomery's firmness in implementing them, British reserve units in GARRISON formation and all units in ENTRENCHED formation cannot move on the first turn, while units manning the front lines in GARRISON formation cannot move until September 4.

# MICRO PROSE

SIMULATION • SOFTWARE

## DEDICATION

This program is dedicated to all the members of the MicroProse staff whose behind the scenes work in marketing, administration, and shipping have made its creation possible.

## CREDITS

### PROGRAMMING AND DESIGN:

Sid Meier

### RESEARCH AND DESIGN:

Ed Bever, Ph.D.

### PLAYTESTING:

John Stanoch, Mike Dodge, Mike LaBruno, Vicki Thomas, Judith Geryk

### DOCUMENTATION:

Sid Meier, Ed Bever, Nick Meriwether, George Geary

### COVER ART:

David Martin

### CONVERSIONS:

Sid Meier (Commodore, Atari), Jim Synoski (Apple), Don Awalt (IBM)

---

MicroProse remains committed to bringing you high quality, real-life simulations which provide excitement, challenge, and learning. We hope that you will enjoy this product and other MicroProse products in the future.

---

## Software Authors!!

MicroProse is always searching for new people, ideas, and products, so we can bring the most challenging and fun products to our customers. If you are working on or have a good idea for quality entertainment, educational, or utility software, call or write us!!! We would like to get you on our team and make you a MicroProse partner!!!

## COPYRIGHT NOTICE

COPYRIGHT 1985® BY MICROPROSE SOFTWARE, INC. ALL RIGHTS RESERVED

This manual and the computer programs on the accompanying floppy disks, which are described by this manual, are copyrighted and contain proprietary information belonging to MICROPROSE SOFTWARE, INC. No one may give or sell copies of this manual or the accompanying disks or of listings of the programs on the disks to any person or institution, except as provided for by the written agreement with MICROPROSE SOFTWARE, INC. No one may copy, photocopy, reproduce, translate this manual or reduce it to machine readable form, in whole or in part, without the prior written consent of MICROPROSE SOFTWARE, INC.

Any person/persons reproducing any portion of this program, in any media, for any reason, shall be guilty of Copyright Violation, and shall be subject to civil liability at the discretion of the copyright holder.

## WARRANTY AND LIABILITY

Neither MICROPROSE SOFTWARE, INC., nor any dealer or distributor makes any warranty, express or implied, with respect to this manual, the disk or any related item, their quality, performance, merchantability, or fitness for any purpose.

It is the responsibility solely of the purchaser to determine the suitability of the products for any purpose. To the original purchaser only, MICROPROSE SOFTWARE, INC. warrants the media to be free from defects in material for 90 days. If during that period a defect should occur, the software may be returned to MICROPROSE SOFTWARE and we will replace the media at no charge to you. If at any time after the initial 90 day period your media becomes defective, the media may be returned to MicroProse Software, and we will replace disks for a \$10 service charge. To ensure identification as the original purchaser, please complete and mail the attached Registration/Warranty card.

In no case will MICROPROSE SOFTWARE, INC. be held liable for direct, indirect or incidental damages resulting from any defect or omission in the manual, or other related items and processes, including, but not limited to, any interruption of service, loss of business, anticipated profit, or other consequential damages.

# SIMULATION SOFTWARE from MICROPROSE

F-15 STRIKE EAGLE is available for Commodore-64, ATARI, and Apple.



Challenging & exciting air combat from the modern electronic cockpit!  
Suggested Retail \$34.95



KENNEDY APPROACH is available for Commodore-64.



You are the Air Traffic Controller in this challenging real life simulation.  
Suggested Retail \$34.95



SOLO FLIGHT is available for Commodore-64, ATARI, Apple, and IBM PC/PC Jr.



As close to the real thrill of flying as you can handle!  
Suggested Retail \$34.95



CRUSADE IN EUROPE is available for Commodore-64, ATARI, and IBM PC/PC Jr.



Lead your armies into the thrill & excitement of one of history's greatest events.  
Suggested Retail \$39.95



# THE ACTION IS SIMULATED - THE EXCITEMENT IS REAL!!

HELLCAT ACE is available for Commodore-64, ATARI, Apple, and IBM PC/PC Jr. (\$34.95)



Exciting 3-dimensional aerial combat over the Pacific in World War II!  
Suggested Retail \$29.95



DECISION IN THE DESERT is available for Commodore-64, ATARI, and IBM PC/PC Jr.

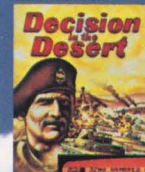

Fire up your computer and take your place among history's great commanders!  
Suggested Retail \$39.95



Suggested Retail \$34.95

Thrilling head-to-head Sabre Jet aerial dog fighting!



MIG ALLEY ACE is available for Commodore-64 and ATARI.

Suggested Retail \$34.95

Heart pounding accelerated real-time defense of Europe against Soviet invasion!



NATO COMMANDER is available for Commodore-64, ATARI, Apple, and IBM PC/PC Jr.

SPITFIRE ACE is available for Commodore-64, ATARI, Apple, and IBM PC/PC Jr. (\$34.95)

Exciting 3-dimensional aerial combat over Europe in World War II!  
Suggested Retail \$29.95



MicroProse Software's exciting and challenging simulations make you the HERO!! MicroProse puts you there — whether you're defending Pearl Harbor, patrolling the skies over the Straits of Hormuz, deploying combat divisions, or guiding the supersonic "Concorde" to a safe landing! We give

you real life situations where you have to depend on your brains, your coordination, and your good guy's luck to survive and win! Our products are not games, but real simulations that will provide you with pleasure and excitement for a long time. You'll never run out of learning new things about your own skills and your ability to rise to the challenge and win!

**MicroProse Software**  
The Action is Simulated — the Excitement is REAL!!

120 Lakefront Dr., Hunt Valley, MD 21030, (301) 667-1151  
Our simulations are available at your local retailer. MicroProse is sold nationally through distributors. Call for further information or write for MC/VISA, Money Order or COD orders. Add \$2.50 for postage and handling (Int'l. add \$4.00 USD) MD residents add 5% sales tax.

Commodore-64, ATARI, APPLE, and IBM are registered trademarks of Commodore Business Machines Inc., ATARI Inc., APPLE Computer Inc., and International Business Machines Inc. respectively.