

# F-16

## COMBAT PILOT



Taken from Amiga-Manuals-Website

### Flight Manual



The Real World of Simulation

COPYRIGHT © DIGITAL INTEGRATION LTD 1989

All rights reserved. No part of this manual may be reproduced, stored in a retrieval system or transmitted in any form or by any means, electronic, mechanical, photocopying, recording or otherwise, without the prior permission of Digital Integration Ltd.

## CONTENTS

FORWARD by Bill Gunston.....	2
Quickstart.....	4
1. Introduction.....	5
2. Arriving at base	
● squadron crewroom / system set up.....	7
● mission selection .....	10
3. Training squadron	
● pre-flight briefing.....	11
● cockpit familiarisation .....	17
● getting airborne / flying training .....	40
4. Front line operations	
● mission selection .....	47
● mission tactics .....	48
● weapon management.....	58
● debriefing .....	68
5. Combat manoeuvres- how to stay one step ahead! .....	70
6. Ground school	
● your aircraft .....	80
● basic aerodynamics.....	82
● weapon loading restrictions .....	86
● flying clothing.....	87
7. Aircraft technical data .....	88
8. Weapon technical data .....	92
Appendix 1 one-on-one communications .....	94
Appendix 2 8 bit versions .....	95
Appendix 3 the team, acknowledgements & further reading .....	96
Glossary .....	99
Index .....	101

## FORWARD

Most of us are kids at heart, with a streak of the Walter Mitty as well. Modern simulation techniques allow us to be almost anybody we wish to be, and for a considerable proportion of the world's population there's nothing more exciting than being a fighter pilot. There's a certain satisfaction in being manager of a vehicle costing 20 or 30 million dollars. There's certainly a rich reward in knowing that you can manage such a high-tech bit of kit with true professionalism. But perhaps the ultimate satisfaction is knowing that your life depends on it, and that in air combat if you don't get him, he'll get you!

Perhaps it's worth emphasizing that this is much more than just a video game. It's the nearest approach to turning you into a real fighter pilot. You probably know already that, even if he has a big moustache and polka-dot scarf, today's fighter jock is highly disciplined and totally professional. If he was otherwise he would never be allowed into the cockpit of an F-16.

Why an F-16? Chiefly because, of all today's fighters, the General Dynamics F-16 most completely typifies the traditional concept of a fighter. Some modern fighters - mostly bigger than the F-16 and usually crewed by two men working in partnership - are called interceptors. They have great range and endurance, and can kill from a distance of up to 100 miles no matter whether it is day or night, or whether there is a snow blizzard or thick fog. Such conditions would make life hard for the F-16, but unlike the big interceptors the F-16 is designed to come to close grips with its enemies. It is designed to win in a traditional visual dogfight, using missiles and an internal gun.

It can also navigate with great accuracy through hostile airspace and plant ordinary 'iron bombs' on a point target. This has been proved 'for real'. On the 7th of June 1981 eight Israeli F-16s flew to a target about 600 miles - almost 1,000 km - away, the Iraqi nuclear reactor at Osirak. They dropped 16 Mk 84 2,000 lb bombs in a single high speed pass over the target, and all 16 bombs appear to have hit the reactor dome. That attack was made easier by the fact that coming out of a clear blue sky the F-16 pilots could see the target from a distance of perhaps a dozen

miles. You really earn your money when you have to use the radar and such extra night or bad-weather aids as LANTIRN pods in order to drop bombs accurately in the winter weather on northern Europe.

The F-16 can also fly reconnaissance missions but for this task it needs to carry an external pod housing infra-red linescan sensors, as well as a secure digital data link to send the outputs back to the Command and Control Centre in real time.

So, here's your chance. Put on your flying suit and go and meet the ground crew. This one's for real.....

### **Bill Gunston**

Former RAF pilot and Technical Editor of "Flight International", Assistant Compiler of "Jane's All The World's Aircraft".

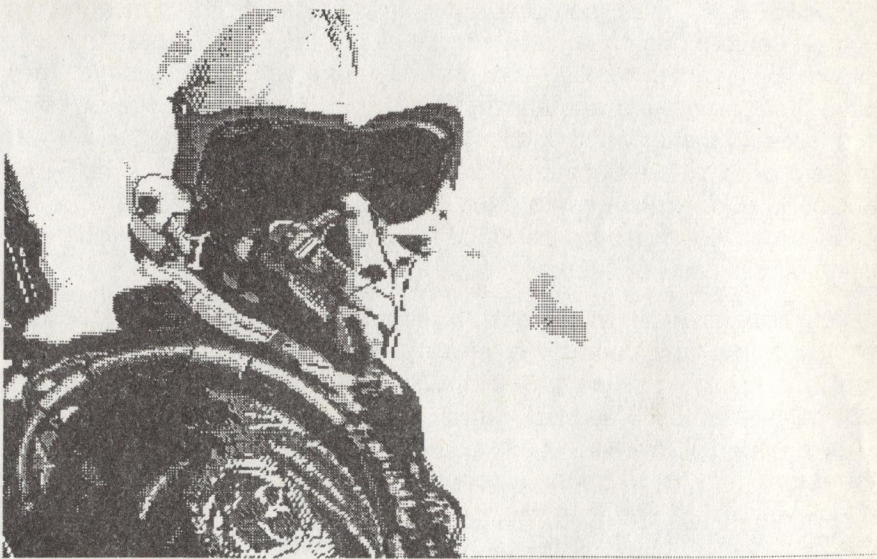

### **QUICKSTART**

Desperate to get airborne? Immediately after the title screen you will be standing in the squadron crewroom. Move the pointer over to pilot and go for it....

#### **Briefing:**

- Temporary posting to Tactical Fighter Training Squadron
- Aircraft fully fuelled, at end of runway
- "General purpose" weapon mix
- No mission selection necessary
- No pre-flight briefing
- No adverse weather conditions
- No pilot's log active
- Controls - see kneepad

Just enter your IFF security code and get airborne.....

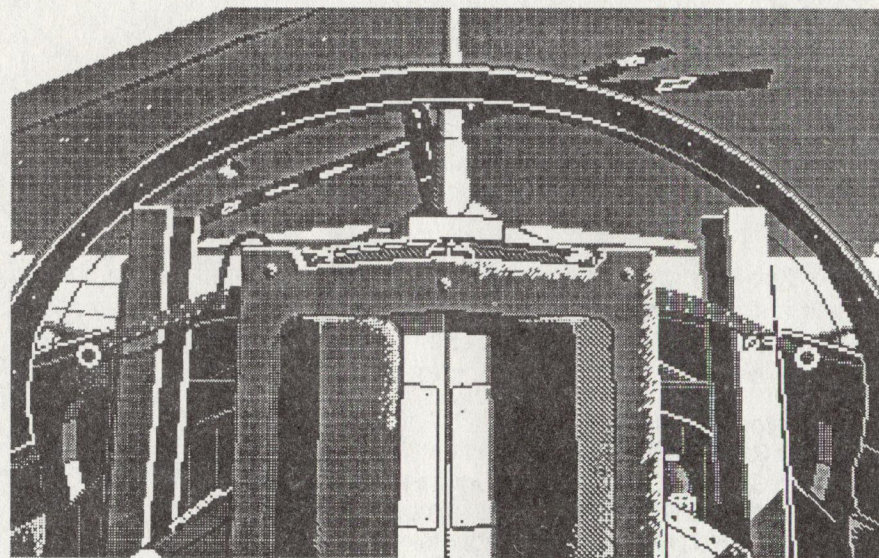

## Chapter 1 INTRODUCTION

Welcome to the world of the F-16 combat pilot. You are about to join an elite group of pilots envied by fighter crews the world over. The F-16 Fighting Falcon is a truly remarkable aircraft, designed originally as a highly manoeuvrable dogfighter and subsequently developed into an awesome multi-role combat aircraft. Every thrilling aspect of the F-16C has been included in this simulation, including many features only just becoming available to the front line squadrons.

F-16 Combat Pilot is the first in a new generation of "strategic" flight simulations. In this single product you will fly on a variety of training missions, join an active front line squadron responsible for each role of the F-16 and ultimately participate in a strategic global conflict involving real-time interaction between aircraft, ground forces and the supporting infrastructure of military installations and essential services. Throughout your flying career your successes (and failures!) will be monitored and logged by Tactical Air Command (TAC) who are well aware of every pilot's ambition to fly with the supreme squadron.

### Overview

Your experience as an F-16 pilot begins in the first of eight squadrons. During your training you will become familiar with the performance and complexities of your new fighting machine. Instructors will be on hand to offer a few words of advice and also to give you a taste of things to come.

Active duty in a front line squadron will be a very different ball game. The targets are real, the enemy is real. Planning your mission is essential if you want to get back in one piece. Still, you have the best aircraft available, and a ground crew second to none.....

### Mission types:

- **TRAINING** – mission practice & aircraft familiarisation
- **SCRAMBLE** – air-to-air interception
- **HAMMERBLOW** – offensive counterair operations
- **DEEPSTRIKE** – interdicator strike
- **TANKBUSTER** – battlefield close air support

- **WATCHTOWER** – reconnaissance
- **GLADIATOR** – two-player dogfight
- **OPERATION CONQUEST** – strategic option

Each squadron is responsible for controlling its airspace of roughly 20,000 sq. miles. For security reasons, the name and location of each squadron is TOP SECRET. After being posted to a new squadron, be ready to familiarise yourself with your new surroundings during the pre-flight briefing – it could save your life!

With the exception of OPERATION CONQUEST, each mission will consist of completing the objective assigned during the pre-flight briefing. Intelligence sources suggest well in excess of 1500 potential targets, both fixed and mobile, within each combat zone. For example, your task may be to destroy an early warning radar on an offensive counterair operation or a particular area may need "photographing" on a reconnaissance mission. In each case, you will be expected to fulfill your objectives within a single flight.

For OPERATION CONQUEST however, you will need experience of all roles of the combat pilot. For this multi-mission scenario, the overall objective is to force the enemy to surrender by reducing his fighting ability and morale. You will experience the passing of day and night, variable weather conditions, the damage of strategic installations, and the deployment of tanks and mobile ground forces. The duration of this operation can vary significantly. To avoid pilot fatigue you will be allowed to request leave, and return when you are in peak fitness.

All Tactical Fighter Squadrons and allied ground forces depend upon industry for supplies of weapons, spares and fuel. The enemy is expected to interrupt these supplies by attacking strategic targets such as power stations, fuel depots and factories. Fortunately, early warning radar installations are monitoring your airspace 24 hours a day. Coordination of all military operations lies with the Command, Control and Communications (C-cubed) centres and military bases. Anticipating the next strike and making the best tactical decisions is your job. HQ Intelligence will do their best to keep you up to date.....

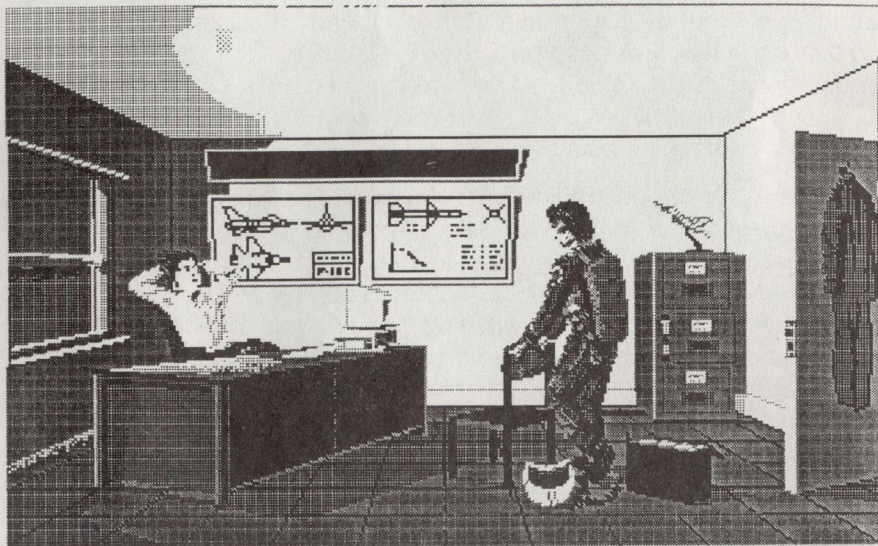

Your day begins in the squadron crewroom. Before getting airborne, let's take a look around. Select any item by simply pointing to the appropriate object.

#### QUICKSTART – (PILOT)

For all you fighter jocks keen to get off the ground without doing any homework! Not recommended for the serious pilot but it will give you a taste of things to come. The default conditions are described earlier.

#### PILOT'S LOG (FILING CABINET)

This is your personal record containing all details of your experience as an F-16 pilot. Select your log by opening the cabinet and giving your name. A new log will be created automatically if the name given is not on file.

- **NAME** – enter your name, up to 8 characters.
- **CALLSIGN** – enter your callsign, up to 10 characters. This will be used during air-to-ground communications.
- **SQUADRON** – You will begin your flying career in the WILDCATTERS squadron. Each time you succeed in Operation Conquest you will be offered a transfer to a new outfit.
- **FLYING HOURS** – total number of hours flown by this pilot
- **KILL RECORD** – total number of enemy aircraft destroyed – total number of ground targets destroyed, Mission Effectiveness ratio (over all missions), Kill Ratio (over all missions), pilot rating

**Mission Effectiveness (ME) ratio =**

no. of assigned targets destroyed / total no. of assigned targets

**Kill Ratio (KR) =**

total number of targets destroyed / number of weapons used

Pilot rating is determined by your ME ratio n.b During your debriefing you will be given ME and KR ratios for the particular mission. These should not be confused with your overall ratios recorded in your log.

- **AIRCRAFT LOST** – total number of aircraft that you have failed to bring back in one piece.
- **OPERATION CONQUEST** – hours in command– victories– losses
- **ERASE** – use ERASE if you no longer wish to keep a particular log

#### FLIGHT CONTROLS (DESKTOP COMPUTER)

Your aircraft may be flown by using only the keyboard but you are strongly advised to use a joystick or mouse in order to create a sense of "feel" in the controls.

#### DEMONSTRATION MODE (WINDOW)

For a dramatic flying display, take a look out of the window!

#### AIRCRAFT TECHNICAL DATA (AIRCRAFT POSTER)

Additional technical data on your aircraft and all likely adversaries is

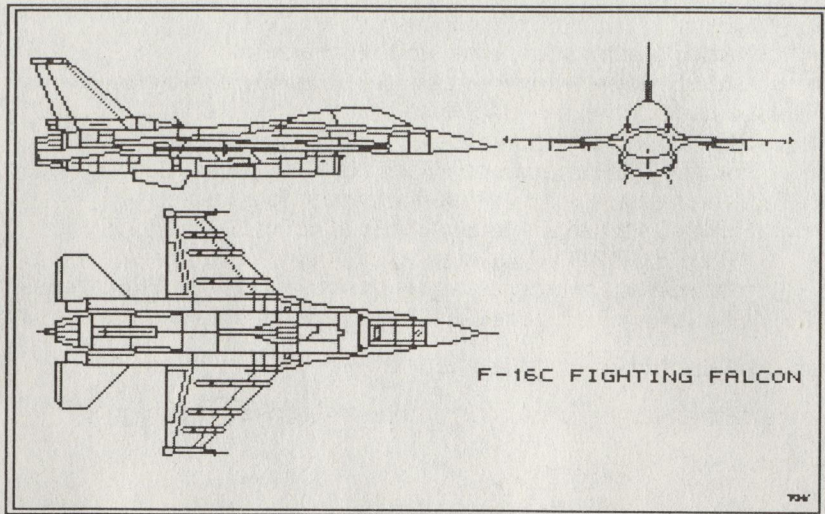

available for further study. Knowing your enemy's capabilities is essential if you are to succeed in air combat.

#### WEAPON TECHNICAL DATA (WEAPON POSTER)

Additional technical data on all weapon systems is available for further study. Familiarise yourself with each weapon, when and how to use it. These are the "tools of your trade".

#### OPERATION CONQUEST – RESTORE (PILOT'S FLIGHT CASE)

On returning from R & R select this option to continue the campaign.

**MISSION SELECTION (DOOR)** Move onto mission selection by leaving the crewroom (via the door!). On leaving the crewroom you will arrive at mission selection.

### Mission selection

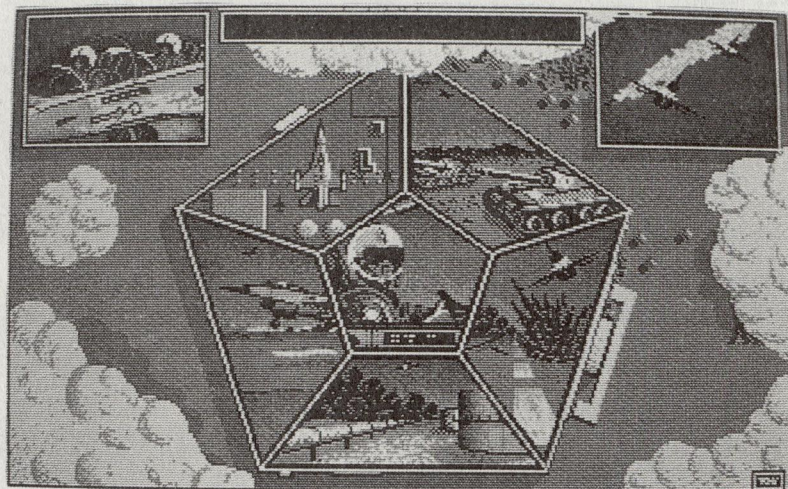

The five sides of the US Pentagon represent each role of the F-16:

- **SCRAMBLE** – air-to-air interception
- **HAMMERBLOW** – offensive counterair operations
- **DEEPSTRIKE** – interdicator strike
- **TANKBUSTER** – battlefield close air support
- **WATCHTOWER** – reconnaissance

The centre icon, used for selecting **OPERATION CONQUEST**, will not appear until you have satisfied Tactical Air Command that you are capable of commanding your squadron on Operation Conquest. For this you must fly a successful mission on each of the above categories, on front line duty, at least once.

In the top left hand corner you will see a two-seat F-16D. Use this to select a temporary posting to the **Tactical Fighter Training Squadron**.

In the top right hand corner is the icon used to select two-player mode. Selecting this will lead you to the Communications set-up screen and **GLADIATOR**, the one-on-one dogfight.

## Chapter 3 TRAINING SQUADRON

Welcome to the Tactical Fighter Training Squadron. Your documentation includes a map of our training area to help you plan your missions during your stay. For those of you not familiar with the F-16 we suggest our Free Flight or Landing Practice course. Mission-oriented training is available for more experienced pilots, covering all aspects of front line duty.

If you are familiar with the pre-flight briefing and the F-16 cockpit, I suggest you skip the next lecture and get airborne as soon as possible.

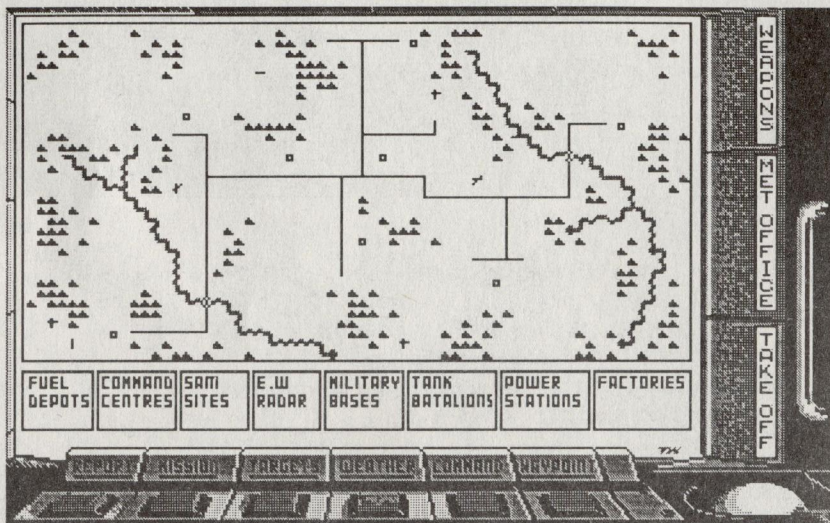

Pre-flight briefing

OK guys. Notebooks at the ready. Your attention please....

Our electronic strategic display is identical to those used by the front line squadrons, showing your current position, all airfield locations, towns and major geographical features. Make sure that you are familiar with the layout – it could save your life!

Along the front of your display are the mode selector switches:

- **MISSION** objectives
- **TARGETS** target selector
- **REPORT** intelligence update
- **WEATHER** met report
- **WAYPOINT** programmer
- **COMMAND** aircraft assignment

These allow you to access various computerised functions that you will need for planning your mission profile. How we ever managed in the old days I'll never know! Select the appropriate key to change the mode of the text area beneath the strategic display:

### MISSION key

With the exception of OPERATION CONQUEST, you will have selected your mission category prior to this meeting. TAC will now release details of your objectives. This information is **CONFIDENTIAL** and is for "your eyes only".

example: MISSION: HAMMERBLOW CALLSIGN: HOTDOG

- TARGET (A) EARLY WARNING RADAR @ 014,283
- TARGET (B) SAM SITE @ 059,268
- TARGET (C) SAM SITE @ 051,259

### TARGETS key

The display defaults to showing only airfield locations and major non-strategic geographical features. Pressing the "TARGETS" switch will illuminate several target selector keys within the text area. The categories are as follows:

- Tank battalions
- Military bases
- Command centres
- Early warning radars
- SAM sites
- Power stations
- Factories
- Fuel depots

Press the appropriate key to highlight (or remove) the desired target category. In the case of mobile targets, the best we can do is to give you their last known positions reported by TAC reconnaissance flights.

### REPORT key

Operators at the Command Centre have been piecing together the latest whispers and hard facts to give you their best advice for your flight. For the latest update, select "REPORT".

Example:

- Interceptor activity high
- Enemy tank battalions @ 487,926
- Allied factories – heavy losses

### WEATHER key

For a brief summary from the met office, select "WEATHER":

Example:

- Cloudbase 25000 ft
- Light SW crosswinds
- Mild turbulence

These conditions may well change during your flight but we can't help that can we?

### WAYPOINT key

So, down to the important task of flight planning. As an F-16 pilot you will not have the luxury of a navigator in the back seat but fortunately you do have the latest programmable navigation computer to give you in-flight guidance via your Up Front Control Panel.

A flight plan may vary from a simple direct route from A to B, to a complex multi-target hi-lo-hi profile over enemy territory. After selecting the waypoint mode, your present position will be highlighted on the strategic display. To set a waypoint, simply move the pointer to the required coordinates and press the "select" key. You will now see your proposed flight route automatically plotted. Further waypoints may be

introduced, up to a maximum of five, each addition extending the flight plan. To cancel a waypoint, place the pointer over the point to be erased and press the "cancel" key. Your flight route will be replotted accordingly. Select the "Waypoint Programmer" box to highlight your

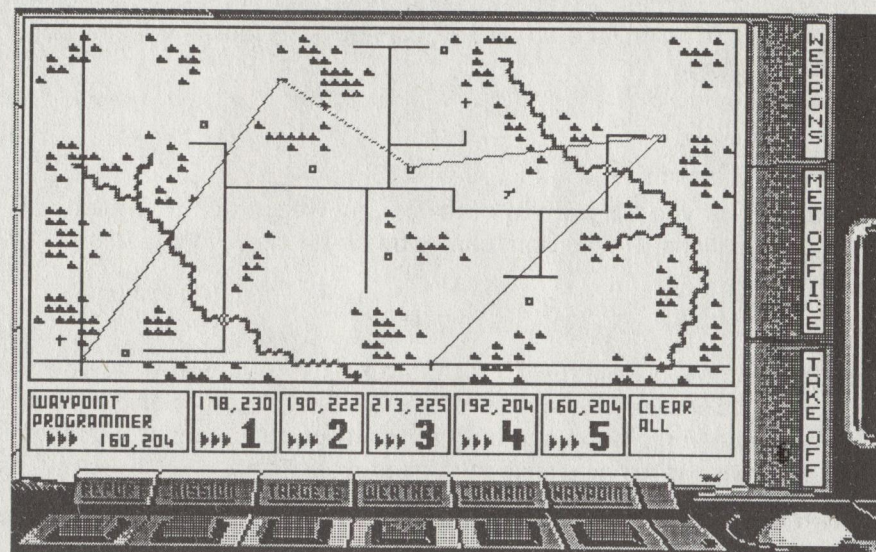

flight route in other display modes. Finally, a "clear all waypoints" option is available.

During flight you may select range, bearing and time-to-go information for each waypoint on your Up Front Control Panel.

### COMMAND key (OPERATION CONQUEST only)

As squadron commander, you may now instruct additional aircraft to execute missions in parallel to your own. Selecting the COMMAND mode will reveal the number of servicable aircraft available at each allied airfield.

To dispatch an aircraft, first contact the airfield. Providing that an aircraft



is available you may now assign target coordinates for its mission by positioning the display pointer at the desired target location and pressing the "select" key. The aircraft's flight route will be plotted as visual confirmation. To cancel an assignment, place the pointer back in the text area at the appropriate airfield symbol and press the "cancel" key. You may assign one aircraft per airfield, up to a maximum of four at any given time, bearing in mind that an aircraft cannot be given new instructions when it is airborne.

## FUNCTION KEYS

Before take-off you will want to consider your weapon configuration and weather conditions. On the right hand side of the display you will see the following:

### MET OFFICE function key

With the exception of OPERATION CONQUEST, TAC will allow you to take off in the weather conditions of your choice. The met office will do their best to comply with your wishes! However, they cannot guarantee that conditions will remain stable throughout your flight.

### WEAPON function key

OK, it's time to take a stroll across to the hangar and meet the ground crew. They have already refuelled your aircraft, rearmed the internal gun, and completed the sub-system ground checks.

Your F-16 has 9 external hardpoints capable of carrying a vast selection of weapons, including the latest laser guided "smart" missiles, and the new AMRAAM "beyond visual range" air-to-air missile. In addition to this we have been cleared to use the first production LANTIRN night vision and target acquisition pods, attached at specific locations either side of the engine intake. These pods will revolutionise our night attack capability.

A.U.W: 26978 lbs FUEL: 0 lbs ROUNDS: 0 MAX G:

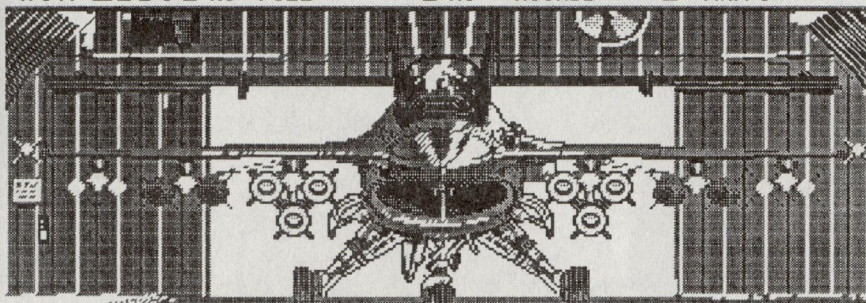

AIM-120A / AGM-65D / MK-82 / MK-84 / LANTIRN / FUEL TANK  
 AIM-9M / AGM-88A / AGM-65E / MK-83 / DURANDAL / ATARS

AIM-9M SIDEWINDER:  
 WEIGHT: 190 lbs  
 2 MOUNTED

GROUND CREW	LOAD STORE	LOAD STORE	LOAD STORE	CLEAN	EXIT
RECOMMENDED	PILOT 1	PILOT 2	PILOT 3		

### Weapon selection

Having decided upon your weapon configuration, check the stock records for availability. Weapons are loaded in pairs by indicating to the ground crew the chosen hardpoint for the weapon. Please bear in mind the loading restrictions explained to you at Ground School – they will not take you seriously if you suggest putting 2000 lb bombs on the wing tips! Keep an eye on your All Up Weight. Although it is not possible to exceed the specified maximum, remember that with increasing weight you become less manoeuvrable. In fact, your F-16 will automatically reduce its maximum g capability if you exceed the 9 g stress loads. Also shown on your load report are your fuel state and ammunition level. You may resort to reducing these if your A.U.W. gets uncomfortably high. Weapons may be loaded and unloaded as often as you wish using "select" and "cancel".

For your convenience, the stores officer will keep a record of up to three "preferred configurations" of your choice in order to speed up turn-around-time between missions. Your ground crew will also be glad

to suggest a weapon mix appropriate to your mission.

### TAKE OFF function key

OK, you know your targets. Time to get airborne. Don't forget your last minute visual checks to make sure that all safety pins and covers are removed. Request permission for take-off, and be prepared to respond with your security clearance. Have a nice flight.....

"You fight like you train"

– Motto, U.S. Navy Fighter Weapons School TOPGUN

### Cockpit familiarisation

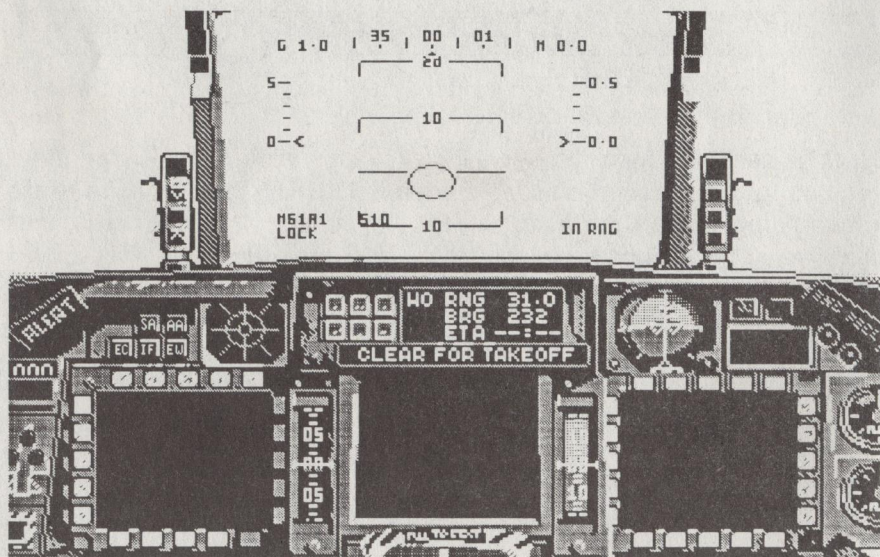

For those of you not familiar with the F-16C, it's time to strap into the reclining ACES II ejection seat and take a look at "the office".

### Multi-function displays (Sperry)

Following the trend in all modern aircraft towards the "glass cockpit", the instrument panel has been modified and updated many times since its first design. You are now looking at the very latest version, including the 3 multi-function digital displays introduced as part of the MSIP avionics update programme. This layout was first evaluated in the AFTI F-16 technology demonstrator.

The major advantage of MFD displays is flexibility. You, the pilot, decide which to use for radar, weapons status, moving map etc. All functions are available on each display, giving you the choice of what to display and in the position you prefer. Refer to your kneepad for mode selection.

### AN/APG-68(V) multi-mode radar (Westinghouse)

For the purpose of our flight, we will concentrate on the short range modes available on this state-of-the-art radar.

#### (a) Air-to-Air modes:

(i) **Track-while-scan (TWS) mode** Effective range approx. 30 nm. Used for air-to-air search for hostile aircraft. The display represents a cross-sectional view of the pilot's field of vision, pointing in the direction of the nose of the aircraft.

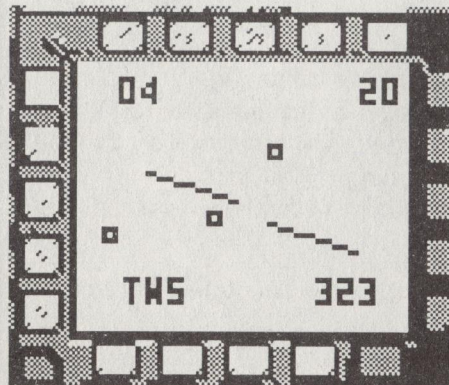

The radar will display all aircraft within its field of view and is capable of tracking up to ten targets simultaneously. Using the "target select" key, you may track any displayed target, with range (top LH corner, miles), altitude (top RH corner, 000's feet), and bearing information

(bottom RH corner) calculated by your weapons computer.

### (ii) Single-target-track (STT) mode

Pressing the “designate” key will switch the radar to “single target track” mode (STT). The selected target will now be displayed as a diamond, with all others removed from the screen. You will also see the target designator box appear on the HUD, showing the position of your target relative to your aircraft together with the LOCK discrete. Return to track-while-scan mode by either pressing the “designate” key again or destroying the target. n.b. If your designated target leaves the radar’s field of view, the display will return to TWS mode.

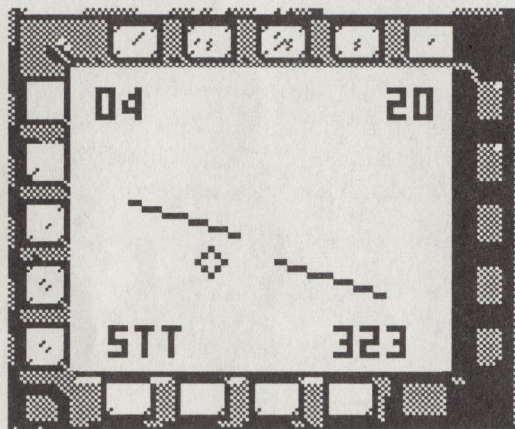

### (iii) Air combat scan (ACS) mode

Using the “dogfight” selector on your throttle control will put your radar in “air combat” mode. Target symbology is the same as STT mode (single diamond) but your weapons computer will automatically lock onto the target of “greatest threat”, excluding allied aircraft of course. Effective range approximately 10 nm. Return to track-while-scan mode by pressing the “designate” key .

Superimposed on all modes you will see the roll orientation bar to assist you when looking down into the cockpit.

### (b) Air-to-Ground modes:

Not to be confused with your GPS moving map display, the radar air-to-ground mode is used for ground target tracking.

### (i) Ground-target-ranging (GTR) mode

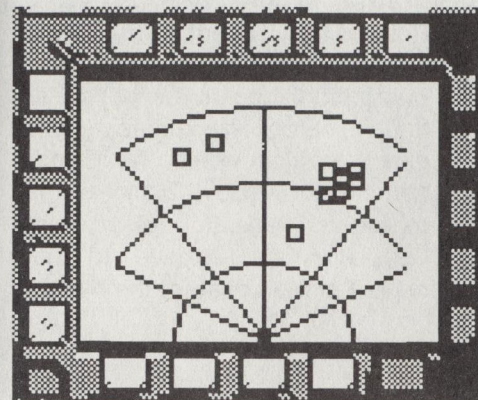

Equivalent to the air-to-air mode “track-while-scan”. The display is now a forward-looking plan view showing fixed installations and mobile ground targets, differentiated by symbology. Using the “target select” key, you may track any displayed target, with range and bearing information shown on the HUD and MFD. Effective range 10nm.

### (ii) Ground-target-track (GTT) mode

Pressing the “designate” key will switch the radar to “ground target track” mode (GTT). The chosen target will now be displayed as a diamond, with all others removed from the screen.

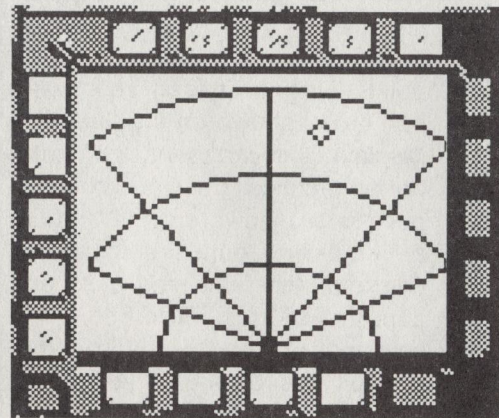

You will also see the target designator box appear on the HUD, showing the position of the target relative to your aircraft together with the LOCK discrete. Return to GTR mode by either pressing the “designate” key again or destroying the target. The display will automatically return to GTR mode if the designated target leaves the radar’s field of view.

## Moving map display

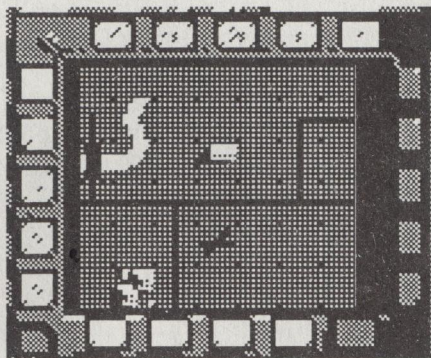

Linked to the tri-service Global Positioning System, this display uses your inertial navigation computer and various external "classified" sources to pinpoint your exact position within the combat zone. The symbolic digital display highlights airfields, hills, towns, waypoints etc, relative to your aircraft at the centre of the MFD.

## Weapon status

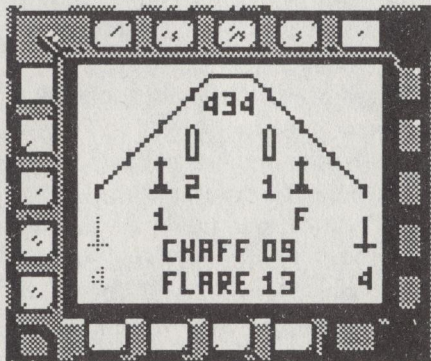

This mode gives a symbolic presentation of your external weapon count on each of the nine hard-points. Having chosen your weapon type, (shown on the Head Up Display) the weapons computer will automatically select the hard-point. Also shown are the number of remaining rounds of ammunition, plus the remaining chaff and flare cartridges. The currently selected weapon is highlighted. Consult this display if you get a "weapon failure" warning.

## Digital Artificial Horizon

We are currently evaluating a new concept in artificial horizon design. A multi-segment circular strip is used to portray the attitude of your aircraft relative to the ground.

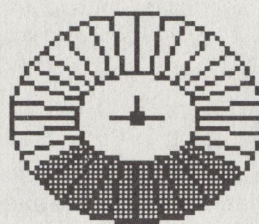

Climb

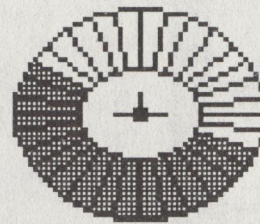

Roll

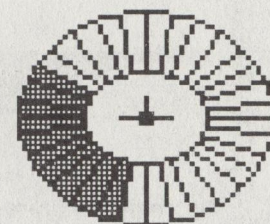

Climb & Roll

Pitching the nose of the aircraft up gives an impression of flying over a "hill" and conversely, diving creates a "valley" effect. The proportions of "sky" and "ground" remain constant as the aircraft rolls. The distinct advantage of this new British design is that unlike the conventional spherical artificial horizon, the pilot is always aware of his aircraft's orientation.

## Primary Flight Data

This direct output from the air data computer replaces the old analog airspeed and altitude indicators that we used to have mounted in the central console. This display is particularly useful in the event of HUD failure or on the approach.

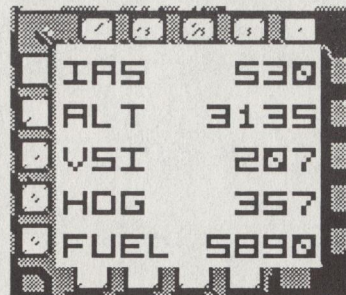

- IAS Indicated airspeed, knots
- ALT Altitude, feet
- VSI Rate of climb, feet per sec.
- HDG Aircraft Heading, degrees
- FUEL Fuel state lbs

## Zoom thermal image – with IIR Maverick and/or LANTIRN

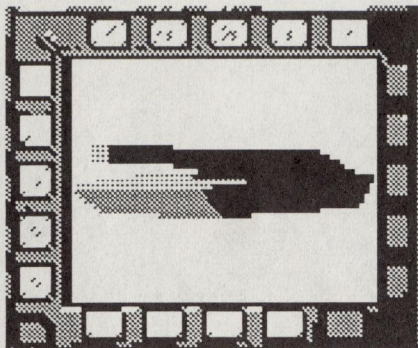

When carrying Maverick AGM-65D (Imaging Infra Red) missiles and/or the LANTIRN pods, you may select a miniature thermal image on any MFD, similar to looking through a telephoto lens. Without LANTIRN, you are effectively viewing the world through the homing head of the missile, restricted in this case to “hot” targets such as tanks and mobile SAM launchers. The image enhancing capabilities of LANTIRN enable you to identify and track any potential target within the capabilities of the selected weapon. (See weapon management, Chapter 4)

lites of the selected weapon. (See weapon management, Chapter 4)

## Instrument Landing System, AN/ARN-108 (Collins)

This display is your primary landing aid. The system consists of two radio beams transmitted from the airfield to help you (a) line up with the runway centreline and (b) approach the airfield descending along the correct glidepath. The equipment on board your F-16 uses the two beams to drive your display.

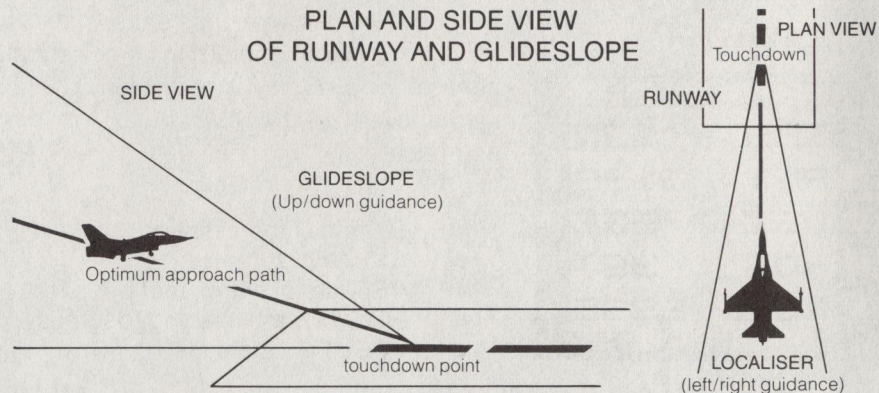

## (a) Localiser

The beam that helps you line up with the runway centreline is called the localiser. As you deviate from alignment with the centreline, the vertical needle on your display will drift in the opposite direction.

e.g. drifting to the left will cause the vertical needle to drift right, and vice versa.

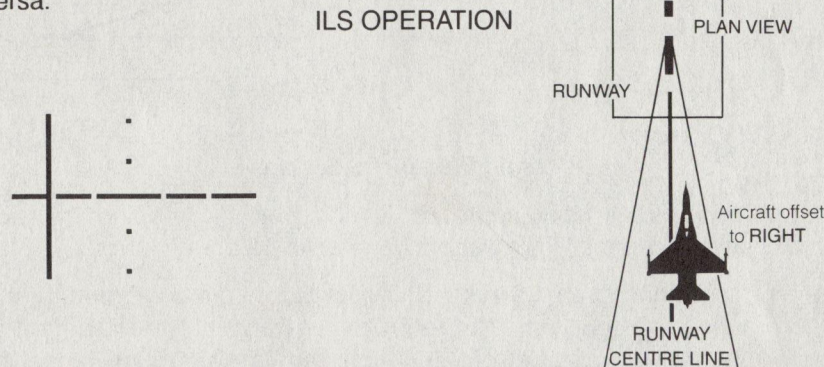

Deviation from the centreline

So, the localiser needle shows your relative offset from the centreline and to correct any error you must turn **towards** the needle. Make a corresponding turn in the opposite direction as the needle centralises to ensure that you finish on the correct heading. It will help if you have your Up Front Control Panel navigation display locked to the airfield for range and bearing information.

## (b) Glideslope

The second beam provides guidance for adjusting your rate of descent during your approach to the runway. The “ideal” glidepath leads to touchdown a few hundred feet beyond the runway threshold. Approaching too high will cause the glideslope needle to be **below** the centre of the display and vice versa. So, to maintain the correct descent rate during your approach, keep the glideslope needle central. Respond if necessary by flying **towards** the needle, i.e. increase your rate of descent if the needle is low; decrease your rate of descent if the needle is high.

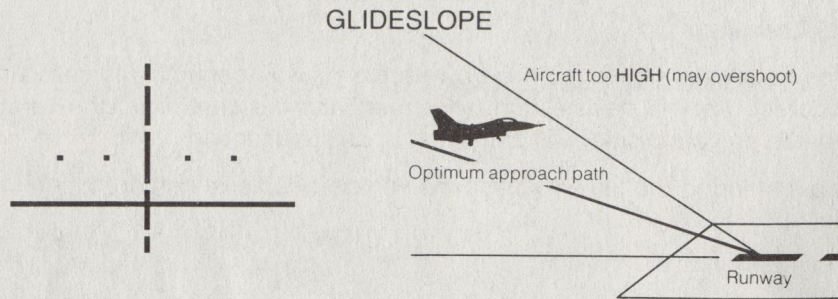

### Deviation from the glideslope

To summarise, your ideal approach is achieved by keeping the two display needles central. "Fly towards the needle" to correct errors.

When in the vicinity of an ILS system, availability will be confirmed by the "ILS in range" light on your Up Front Control Panel. The landing aid is effective up to an altitude of 5000 feet at its maximum range of approximately 15 miles. n.b. Not all runways have ILS transmitters.

### Other instruments:

#### Radar Warning Receiver, AN/ALR-69 (Dalmo Victor)

To the left of the Up Front Control Panel you will see a small circular display. This is your passive Radar Warning Receiver. Sensors positioned around your F-16 are used to detect radar transmissions from enemy aircraft, radar guided missiles and enemy early warning radar stations. Used in conjunction with your Threat Warning Panel, it is possible to determine the source and direction of the threat. It is interesting to note that an enemy aircraft using his air-to-air radar will be detected by your Radar Warning Receiver before he is aware of your presence. This is because your

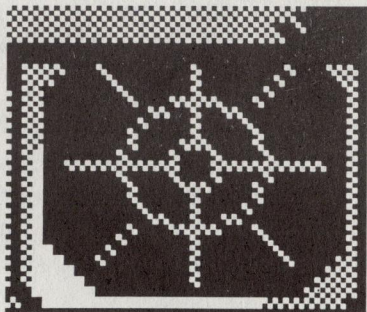

radar reflection will initially be too weak to be "seen" by the enemy radar. This illustrates the importance of maintaining "radar silence" wherever possible.

#### Attitude Director Indicator (Clifton Precision)

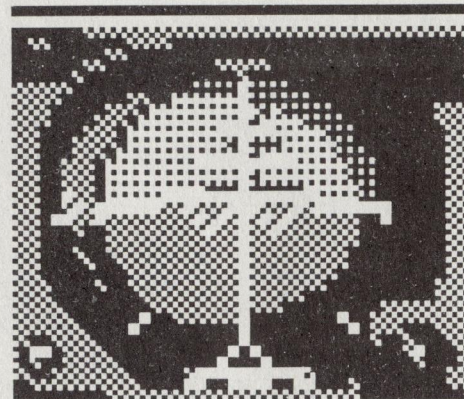

To the right of the Up Front Control Panel is your Attitude Director Indicator, otherwise known as the standby artificial horizon. This instrument shows the pitch and roll attitude of your aircraft.

#### Angle of Attack indicator (Gull Airborne)



The vertical "tape" scale to the left of the centre MFD is the Angle of Attack indicator. Refer to your ground school notes for a description of angle of attack, lift etc. From the practical point of view, you can imagine angle of attack as a measure of how hard the wing is having to work to generate the required amount of lift. For stability reasons, the angle of attack is automatically limited to 25 degrees by the fly-by-wire control system. A typical value during landing is 12 to 13 degrees.

## Vertical Speed indicator

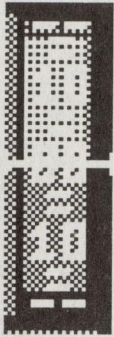

To the right of the central MFD you will find the Vertical Speed Indicator. Calibrated in feet per second, this "tape" scale shows your rate of climb and descent. This instrument is particularly useful during the landing phase, but dramatic rates of climb/descent will exceed the full scale deflection.

## Engine rpm indicator

On the far left hand side of the instrument panel, below the Master Caution light, you will see the new digital engine rpm indicator together with the afterburner indicator. The old analogue engine rpm indicator is in the usual place, over by your right knee.

You will be pleased to hear that we now have the General Electric F110-GE-100 engine, rated at 27000 lbf maximum thrust. On power up the engine control system will adjust the idle rpm to around 60%. The throttle lever by your left hand adjusts engine rpm up to 100% and then, after passing a detent, moves through into reheat by pushing the control further forward. The amount of reheat selected is shown on the afterburner indicator. For your convenience a second digital rpm display is mounted next to the throttle control.

## Fuel gauge

Over on the right hand side you will see the fuel gauge, together with the "fuel low" and "external tanks empty" warning lights. The gauge has two needles; one for internal fuel supply, and a second for external fuel load. Fuel is consumed from the external tanks first.



Internal: Full

External: In use



Internal: In use

External: Empty

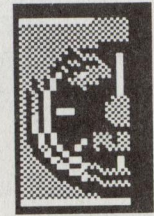

Internal: Empty

External: Empty

Please bear in mind that for a given throttle setting, fuel consumption DECREASES as you gain altitude. Optimum performance is reached at the normal cruise altitude of around 35000 ft where we find that fuel consumption is roughly a quarter of the rate at sea level, giving an approximate flight duration of two hours and a tactical radius of 500 n.m. on full internal fuel. Using reheat does however consume fuel very rapidly giving a total duration with maximum reheat at sea level of less than ten minutes!

## Up Front Control Panel (UFCP)

This panel houses essential Communications, Navigation and Identification functions (CNI):



(a) CNI Datalink

The largest portion of the UFCP is dedicated to a three function datalink display. Airfield and waypoint navigation data is derived from your Inertial

Navigation System LN-39. Tracking data for enemy aircraft is obtained via datalink with allied Early Warning radar stations. Use the UFCP mode selector to cycle through the following modes:

#### (i) **Airfield**

Range, bearing and ETA information is available on all allied airfields. Select the required airfield using the UFCP channel selector.

e.g. A3 Airfield 3

- RNG 89 range 89 miles
- BRG 245 bearing 245 degs
- ETA 9:13 estimated time to arrival 9 mins 13 secs

#### (ii) **Waypoint**

Range, bearing and ETA information is available on all waypoints defined prior to takeoff. Select the required waypoint using the UFCP channel selector.

e.g. W1 waypoint 1

- RNG 26 range 26 miles
- BRG 172 bearing 172 degs
- ETA 2:41 estimated time to arrival 2 mins 41 secs

n.b. To fly towards your selected target, adjust your heading to match the target bearing. The estimated time assumes you are heading towards the target at your present speed.

#### (iii) **Tracking**

Allied early warning radar stations will relay tracking information on all hostile aircraft currently being monitored. Select the required channel for range, bearing and altitude data, relative to your own aircraft.

e.g. T2 target 2

- RNG 90 range 90 miles
- BRG 018 bearing 18 degs
- ALT 35 altitude 35000 ft

#### (b) **System Control Functions**

To the left of the datalink display you will see six indicator lights:

Top row (left to right):

- “**Recce pod on**” Confirms ATARS pod on/off (manual)
- “**LANTIRN**” Confirms targetting pod on/off (automatic)
- “**RADAR**” Confirms RADAR system on/off (MFD selected)

Bottom row (left to right):

- “**ILS in range**” Your aircraft is within range of an ILS system
- “**Autopilot**” Confirms selection of automatic landing system
- “**UHF transmit**” Confirms transmission of callsign

(c) **UHF Communications Transceiver** AN/ARC-164 (Magnavox)



Mounted along the bottom of the UFCP is your UHF communications display. This is used for receiving numerous in-flight messages from airfields, command centres and EW radar installations.

#### **Data entry panel**

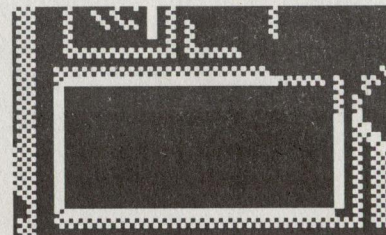

Before take-off you will be asked by the control tower for your IFF (Identification Friend or Foe) security code. Having made the appropriate response via your Data Entry Panel you will be cleared to start your engine, taxi and take off.



## Threat Warning Panel

Immediately to the left of the Radar Warning Receiver you will find your Threat Warning Panel. This consists of five warning lights, each designed to bring to your attention a particular type of threat.



- **SAM** – launch of surface to air missile detected. Threat will appear on your Radar Warning Receiver if radar guided, otherwise you can assume infra-red guidance. Respond by releasing chaff or flares. Manoeuvre to deplete missile energy and maximise tracking errors.
- **AAM** – launch of air to air missile detected. Threat will appear on your Radar Warning Receiver if radar guided, otherwise you can assume infra-red guidance. Respond by releasing chaff or flares. Manoeuvre to deplete missile energy and maximise tracking errors.
- **ECM** – enemy is transmitting Electronic Countermeasures in an attempt to defeat your tracking radar or air-to-air missile.
- **IFF** – you are being tracked by the radar of an enemy aircraft. Consult your Radar Warning Receiver to determine his approximate bearing.
- **EWR** – you are being tracked by an enemy Early Warning Radar installation. Consult your Radar Warning Receiver to determine its approximate bearing.

Your Airborne Self Protection Jammer (ASPJ, AN/ALQ-165, Westinghouse/ITT) should automatically attempt to break any radar tracking beam but don't depend upon it too heavily. Once the enemy are aware of your approach they are not going to give up trying to track you and far worse, you can expect to be met fairly soon by enemy interceptors. To break the lock, fly as low as possible and alter your course.

## Warning lights

- **ALERT** master caution light. Attracts your attention when any "subsystem" fails. Consult your Failure Status Panel to determine the precise failure.
- **ENG** engine failure – not a pleasant sight considering that you have only one engine! Given sufficient altitude and a nearby airfield you should be able to execute a "dead stick" landing. Practice makes perfect!
- **FIRE** warning of on board fire. Your only option is to eject.
- **FUEL** fuel low warning. Flashes when fuel low, stays lit when out of fuel. Do not ignore! The consequences lead to unscheduled gliding practice....
- **EXT** external fuel tanks empty – confirms empty tanks as cue to jettison if required.

## Other lights

- **Undercarriage** – extreme left of instrument panel. Three GREENs confirm undercarriage DOWN. Three REDS confirm undercarriage UP.
- **Jettison** – below the undercarriage light. You may jettison only external tanks, or jettison all external load with the exception of missiles fitted to the wingtips. The light illuminates to confirm operation.
- **Wheel brakes** – illuminated when wheel brakes are ON
- **Air brakes** – illuminated when air brakes are ON

**Eject handle** – below the centre MFD. When all else fails, this is the last resort. Pulling the "loud handle" could save your life but don't use it at low altitude when inverted.....

## Left hand panel

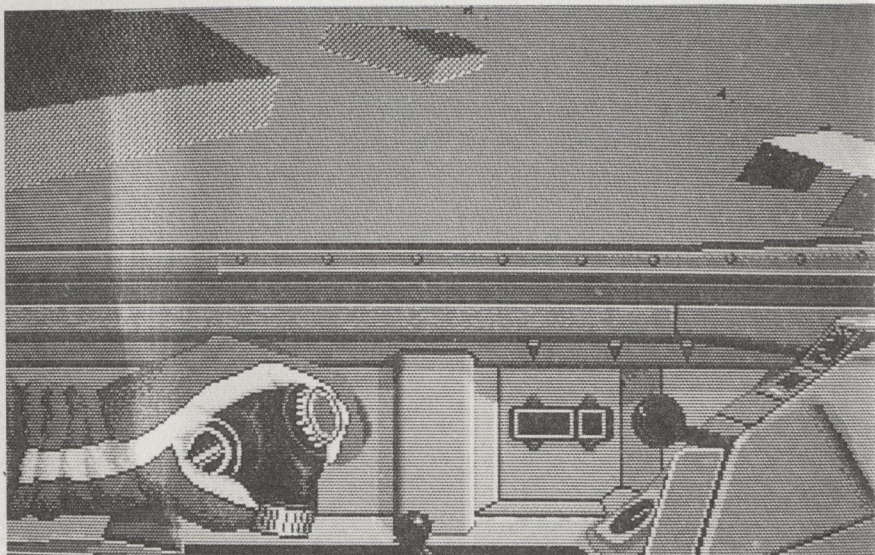

Turning to your left you will see the throttle grip which is used to control engine rpm and reheat in the normal manner – forward to increase, back to decrease. You will probably notice a slight delay between your throttle movement and the change in engine rpm. This is quite normal and is due to the inertia of the engine's rotating blades. Once lit, your engine control system will prohibit a deliberate shut down of the engine.

Typical engine rpm at the idle setting is about 60%. The power curve of the engine gives a gradual increase in thrust up to around 90% rpm, above which you will experience a rapid thrust increase up to 100% rpm. This is the maximum "dry" thrust or full military power. Further engine thrust is achieved with the selection of reheat. The principle operates on spraying additional fuel into the engine exhaust whereupon it ignites to provide a significant increase in thrust e.g. from 16000 lb to 27000 lb. Reheat is selected by moving the throttle grip through a detent beyond which you have linear control up to maximum thrust. To select reheat,

push the throttle until you reach 100% rpm, release the throttle momentarily and then continue to push to the required reheat level as indicated next to the rpm readout. n.b. Engine rpm does not increase with the selection of reheat. Reheat will cause a dramatic increase in fuel consumption. Use it sparingly!

## Right hand panel

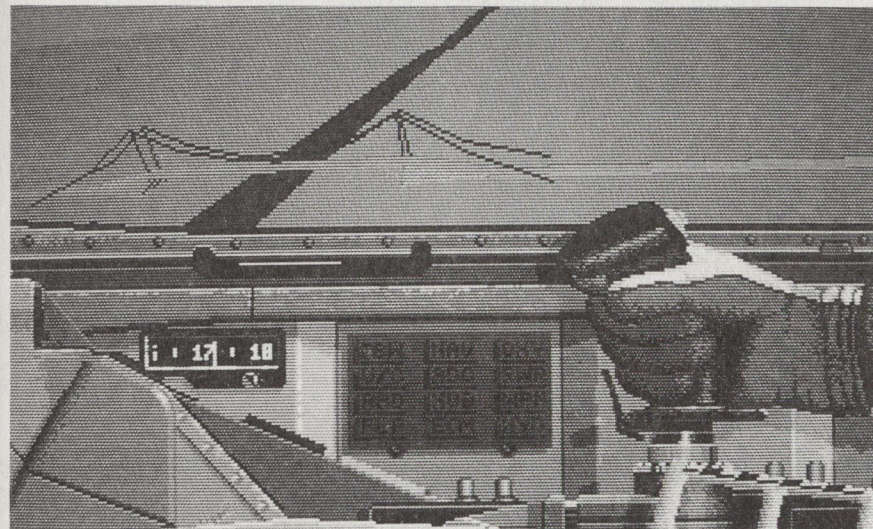

Looking over to your right you will see the sidestick controller. Instead of a conventional control column, your F-16 is fitted with a force-sensitive sidestick. Movement is minimal, with pitch and roll rates being proportional to the pressure applied. The sidestick also offers a nose wheel steering facility when moving on the ground at speeds below 95 kts.

## Mechanical compass

Further forward you will see the back up mechanical compass, calibrated every 10 degrees e.g. 09 = East, 18 = South, 27 = West, 36 = North

Also on the right hand side you have the **Failure Status panel**. Consult this panel when you see the Master Caution light illuminate.

- **FBW** – failure of fly-by-wire channel. Results in reduced aircraft agility. Control system gains halved.
- **U/C** – undercarriage failure. If you cannot lower your undercarriage you will have no option but to do a “wheels up” landing – VERY GENTLY! One of the early prototypes managed it and just scraped the paint – it is possible.
- **RAD** – radar failure. All radar modes lost.
- **OXY** – oxygen system failure. Flight above 8000 feet will lead to impaired vision and eventually loss of consciousness.
- **NAV** – failure of the INS. All navigation aids on your UFCP will cease to function.
- **LAN** – failure of LANTIRN night vision pod or targetting pod. Automatic target selection will be lost. Enhanced night vision will be lost.
- **HUD** – failure of the Head Up Display. Loss of all weapon aiming functions and head up flight data – speed, altitude etc.
- **ECM** – failure of ASPJ ECM jammer. More susceptible to radar tracking.
- **COM** – failure of communications transceiver. GCA option no longer available.
- **RWR** – failure of Radar Warning Receiver. Detection of enemy radar tracking beams will cease.
- **WPN** – weapon failure. Consult weapon status display on an MFD to determine precise failure.
- **ILS** – failure of Instrument Landing System. Automatic landing will no longer be available since autopilot uses the ILS system.

## Rear view

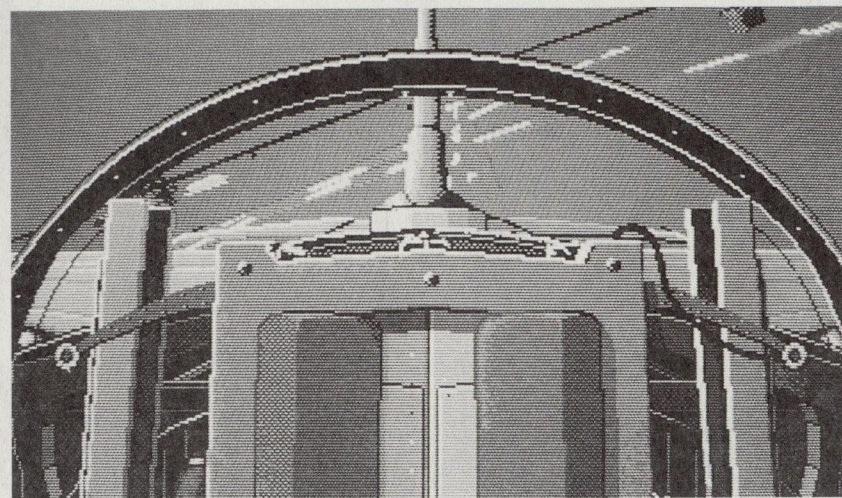

Your F-16 offers excellent all round vision from the cockpit. During combat manoeuvres this is essential. Make sure that periodically you look out each side and to the rear to check for hostile aircraft.

“One peek is worth a thousand radar sweeps” – Unknown

## Head Up Display (GEC Avionics UK)

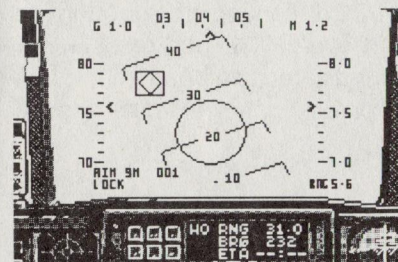

Superimposed upon your view ahead is a projection of symbolic and alphanumeric information. Essential information such as airspeed, heading, altitude and weapon aiming symbology are presented enabling you to focus outside the cockpit (“head up”) for the majority of the time. The display also has the ability to present a “daylight” infra-red image when used in conjunction with LANTIRN for night flying.

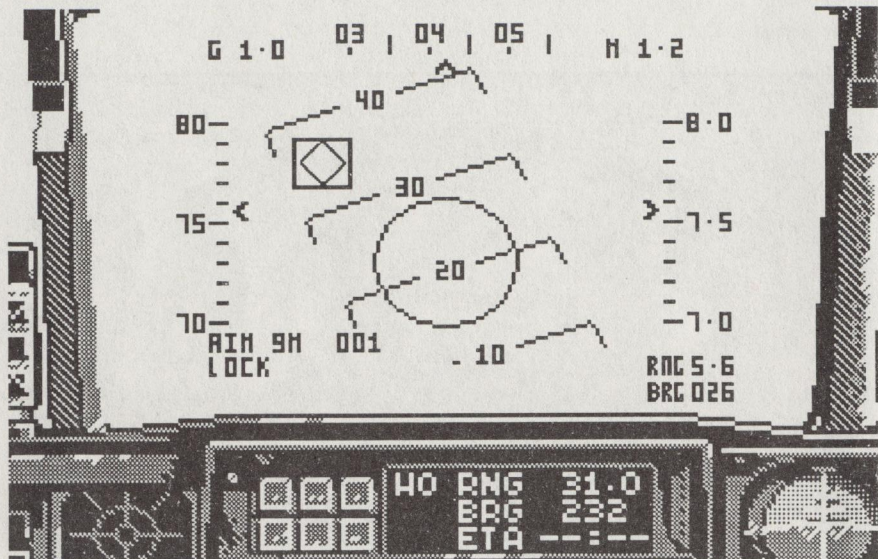

Head Up Display

### Aircraft heading

Magnetic compass heading across top of display. Incrementing left to right, notated in units of 10 degrees, calibrated every 5 degrees, resolution 1 degree. Central marker at your present heading.

### Indicated airspeed

Vertical scale on left hand side of display. Incrementing from bottom to top, notated in units of 10 knots, calibrated every 10 knots, resolution 2 knots. Central marker shows your current indicated airspeed (n.b. NOT true airspeed; see Ground School notes for description of difference if you are not sure).

### Altitude

Vertical scale on right hand side of display. Incrementing from bottom to top, notated in units of 1000 feet, calibrated every 100 feet, resolution 20 feet. Central marker at your present altitude.

### Flight Path Ladder

Pitch bars (switch selectable) show aircraft pitch and roll attitude relative to the ground. Ends of bars point downwards when climbing and upwards when diving. Notated in units of 10 degrees. Present value intersects centre of HUD.

### Aircraft symbol

At the centre of the HUD is a small symbol representing your aircraft. The symbol inverts to show inverted flight.

### g force

At the top left hand corner of the HUD you will see a readout of g force (weight multiplying factor) currently acting upon your aircraft and you.

### Mach number

Your speed is given at the top right hand corner, expressed in units of the speed of sound at your present altitude.

### Range

The uppermost figure at the bottom right hand corner of the HUD is the distance, in miles, to your current target.

### Bearing

Immediately below Range you will find target bearing. Adjust your heading to this value in order to fly directly towards the target.

### Weapon symbology:

Selecting a particular weapon will be confirmed on the HUD by its abbreviation or "discrete":

- **M61A1** cannon
- **AIM9M** Sidewinder
- **AIM120** Amraam
- **DUR** Durandal
- **AGM88** HARM
- **MK84** 2000lb bomb

- **MK83** 1000lb bomb
- **AGM65D** IIR Maverick
- **AGM65E** Laser Maverick
- **MK82** Snakeye bomb

plus no. of weapon type remaining

- **LOCK** radar locked on to target
- **IN RNG** in range cue for selected weapon

### Ranging reticle

After designating a target on your radar, the ranging reticle will appear at the centre of the HUD. This symbol provides a dynamic visual cue of the range to your target.

### Target designator

This small box gives you an indication of where your target will appear on the HUD as it comes within visual range.

### Lock-on diamond

Once the launch parameters of your chosen weapon are fulfilled, the homing head will confirm lock-on by superimposing a diamond over the target.

### CCIP

To ensure accurate delivery of unguided bombs, your weapons computer offers a Continuously Computed Impact Point, displayed on the HUD for the appropriate weapons. Place the displayed "impact point" over the desired target at the point of release.

That just about covers everything. Any questions?

## Getting airborne

OK. Time to get airborne. "Free flight" is a good place to start if you're low on flying hours. Don't forget to register your pilot's log – paperwork is important too!

### Free flight

On all training missions your flight will begin with a fully servicable aircraft, loaded with a weapon configuration appropriate to the sortie. Having requested permission to take-off, the control tower will ask for your IFF (Identification Friend or Foe) security code. Clearance to start your engine and taxi to the runway will then follow.

Check your straps, one last look around – all clear – power up! Engine rpm will rapidly reach idle level (approximately 60%). Nudge the throttle forward gently to start taxiing away from the hangar. Steer by using either the sidestick controller (Nose Wheel Steering) or the rudder pedals (differential braking). Make your way over to the end of the runway, line up with the centreline, throttle back to idle and apply the wheel brakes.

Canopy locked. Control surfaces functioning. Clear for take-off. Holding the wheel brakes on, open the throttle to 80% rpm. Release the brakes, open the throttle to 100% and follow through to full reheat. Hold tight! At a typical combat weight, this bird accelerates from 0 to 125 kts in approximately 10 seconds. As your speed passes through 125 kts, pull back gently on the sidestick to raise the nose. You will become airborne at roughly 150 kts with the speed continuing to increase even if you pull up into a vertical climb, providing that your All Up Weight is not in excess of 26000lb or so. Normal climb out from the airfield is at about 60 degrees. Retract the undercarriage immediately – you'll stress the retraction mechanism if you exceed 300 kts with the wheels down and your ground crew will NOT be pleased. Flaperon operation is totally automatic with the fly-by-wire system adjusting the leading and trailing edge settings for optimum wing lift at all times. (See your ground school notes)

Having reached about 5000 feet, pull the throttle out of reheat and begin with a few gentle turns left and right to get a feel of the aircraft's

response. Remember to keep an eye open for other aircraft as you manoeuvre. As you bank your aircraft the “g” force required to sustain the turn increases. If you do not pull back on the sidestick as you roll, your aircraft will start to slip into the turn and the nose will fall slowly. Momentary back pressure on the sidestick will “trim” the aircraft by increasing your angle of attack and you will see a corresponding increase in “g” force (top left corner of the HUD).

Once you become confident, try a few 360 degree rolls and tight turns. Notice how the maximum roll rate increases with forward speed. When manoeuvring at lower speeds you will notice the fly-by-wire control system limiting your angle of attack to 25 degrees. This is a built-in design feature to help you avoid stalling or spinning. If the aircraft finds that it cannot generate the required lift, the nose will automatically be lowered in order to increase the airspeed. For a more detailed discussion on aerodynamics, see your ground school notes.

Similarly, at higher speeds the pitch rate is automatically limited to avoid overstressing the airframe. The F-16 will allow you to pull up to 9g (within its combat speed range) but don't expect to hold this for very long or you will black out. The effect is only temporary but things could get nasty at low altitude. Even worse, pushing on the sidestick will build up negative “g” resulting in “redout” – NOT to be recommended.

During a sustained turn the wings need to generate extra lift if the aircraft is not to lose altitude. This extra lift is generated by increasing the wing incidence which in turn creates extra aerodynamic drag. So, in a turn, you will notice your speed decay if you do not compensate by increasing the engine thrust. For example, in a 9g turn at approximately 600 kts you may need all the thrust you have – including reheat – depending upon your aircraft weight.

Here's an interesting manoeuvre. Roll your aircraft to approximately 45 degrees and pull up into a climbing turn. As you continue to pull you will perform an “off-axis” loop i.e. inclined to the vertical.

During the manoeuvre you will see changes in both pitch and roll angles,

## OFF-AXIS LOOP

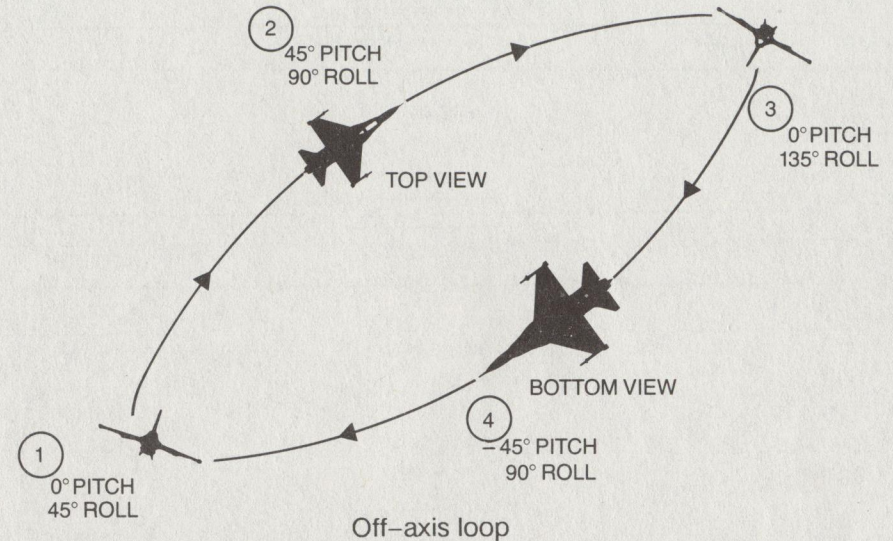

with pitch increasing to about 45 degrees and then decreasing as you pull into inverted flight. (See diagram above) Unfortunately the ground school simulator doesn't get this right and ends up pitching over 90 degrees, even at steep roll angles!

During “free flight” you are invited to fly to any of the designated ranges for target practice. You will NOT be subjected to dummy SAM alerts and drone interceptor aircraft – you will probably have enough on your plate already.

Before getting too adventurous, it will be well worth while to practise your take-off and landing technique, usually referred to as “circuits and bumps”. The idea is to remain within the airfield “circuit”, getting familiar with landmarks, perspectives and aircraft handling.

The following illustration is a suggested circuit pattern with distances and altitudes that should give you plenty of time to correct for errors. As you become more proficient you will be able to stay much closer to the airfield, perhaps performing “airshow style” tight-turn take-offs and approaches.

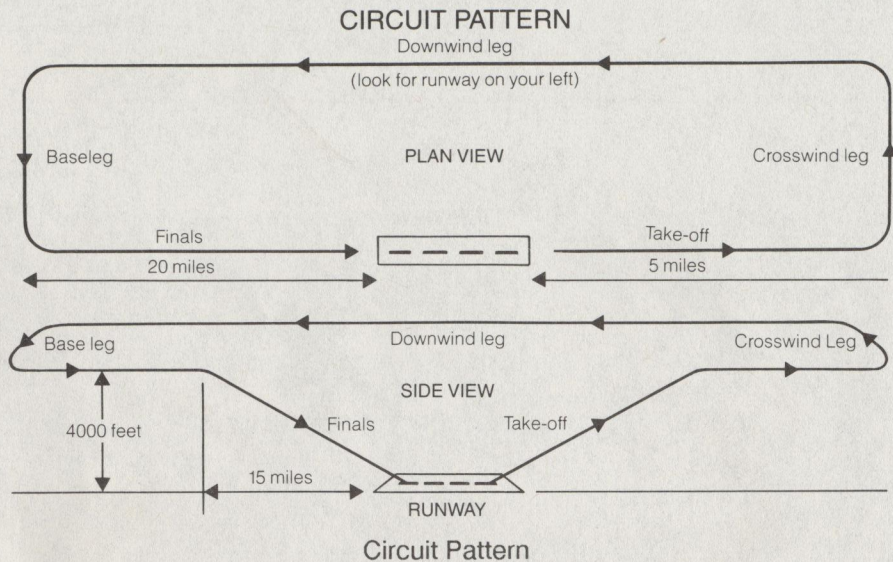

So, let's start thinking about getting back down. On your Up Front Control Panel should be range and bearing information for the airfield. Turn onto the displayed bearing and your Inertial Navigation System will show you the estimate time to arrival. Aim to be approaching the airfield at about 125 kts, at 4000 ft altitude and 15 miles from touchdown. For assistance from the control tower, transmit your callsign and request a Ground Control Approach (GCA). If you would like to practise your landing technique, ask the instructor to position your aircraft on the approach by requesting "Landing Practice" prior to take-off.

### Landing Practice

Your flight begins at 2500 ft, lined up with the runway 10 miles from touchdown. At a typical approach speed of 125 kts you will have approximately 4 minutes before crossing the runway threshold. During your approach you may either (a) proceed without assistance (b) request a GCA talkdown (Ground Control Approach) or (c) select autopilot. Option (a) is what you should be aiming for, option (b) will give you a little help from the control tower, and option (c) is for those who want to see how it SHOULD be done.

### (a) manual approach

Checklist: (all values approximate and will vary with aircraft weight)

- throttle 78 %
- speed 125 kts
- altitude 2500 ft
- AoA approx. 13 degs
- VSI -11 ft/s
- pitch +5degs
- touchdown 10 mls
- undercarriage down

Contact the airfield control tower by transmitting your callsign. Be prepared for the response:

- "ROGER callsign"
- "STATUS GREEN"
- "CLEAR TO LAND"

Use your Instrument Landing System to ensure that you maintain the correct glideslope during the approach. Lowering the undercarriage will make the aircraft response less agile (imposed by the fly-by-wire system) and the flaps will automatically adopt the landing configuration. Be ready to adjust the throttle slightly to account for the extra drag. Aim to touchdown a few hundred feet beyond the runway threshold, remembering to "flare" (pull the nose up slightly) just before touchdown in order to reduce your rate of descent. After touchdown close the throttle and apply your wheel brakes after the nosewheel has lowered. Having finally stopped, take a look around for the nearest hangar, open the throttle slightly and begin to taxi. Your debrief will begin after stopping inside the hangar.

### (b) Ground Control Approach, GCA

Select the required airfield on your UFCP and transmit your callsign.

Tower response:

- "ROGER FALCON"
- "STATUS GREEN" airfield combat status
- "CLEAR TO LAND"

Request GCA to start GCA approach

- "ROGER FALCON"
- "STARTING GCA"
- "TURN LEFT TO 270" adjust your heading to 270
- "DESCEND TO 2500 FT" adjust your altitude
- "FINAL APPROACH" turn into final approach
- "HDG 360 VSI -8" adjust heading and rate of descent
- "HDG OK VSI OK" on finals ...
- "WELCOME TO BASE" after touchdown

### (c) Autopilot

Your aircraft is fitted with a landing aid which links the autopilot with the Instrument Landing System to give a fully automated landing. This may only be used if both your ILS equipment is functioning and ILS is available on the selected runway. The autopilot may be selected whenever the "ILS in range" light on the UFCP is lit. Control is fully automatic as far as touchdown after which you will throttle back and apply the wheel brakes as usual.

### (d) Dead stick landing

If you are unfortunate enough to be faced with a "dead stick" landing i.e. gliding in after engine failure, first ensure that all external stores are jettisoned. For a fixed wing fighter, the F-16 is very efficient at gliding with a typical altitude loss of 750 feet for every nautical mile flown. Adopting a slightly nose down attitude, maintain an indicated airspeed of approximately 170 kts to give you the optimum glidepath. Your VSI should be around 40 feet per second. Do not put your undercarriage down during the approach – you cannot afford the extra drag. As you approach the runway threshold, lower your undercarriage and pull gently on the sidestick to flare and reduce your rate of descent to around 5 to 10 ft/sec. With practice you will be able to execute this manoeuvre with confidence – practice makes perfect! Having made a safe touchdown and brought your aircraft to a standstill, you will of course not be able to taxi to the hangar. The ground crew will be along shortly to congratulate you....

It is vital that you perfect the technique of landing your aircraft safely! The only good landing is one that you can walk away from, with your aircraft in one piece!

### Flying training

During training, you may select a dummy "front line mission" for any role of the F-16.

- SCRAMBLE – air-to-air interception
- HAMMERBLOW – offensive counterair operations
- DEEPSTRIKE – interdicator strike
- TANKBUSTER – battlefield close air support
- WATCHTOWER – reconnaissance

Objectives will be assigned appropriate to your mission with simulated SAM warnings and "hostile" drone aircraft injected to maximise the "realism" of your sortie. Although there is no danger of actually being shot down, you will be warned of any "simulated kill" if you would not have survived in real combat.

Remember to take notes during your pre-flight briefing and plan your flight route carefully. Your ground crew will ensure that your aircraft is fully serviced, refuelled and armed with a weapon mix appropriate to your mission.

"Know and use all the capabilities of your airplane. If you don't, sooner or later, some guy who does will kick your ass."

– Lt. D.Pace, U.S. Navy FWS Instructor



## Chapter 4 FRONT LINE OPERATIONS

WARNING! Do NOT embark upon a mission without training....it is DANGEROUS!

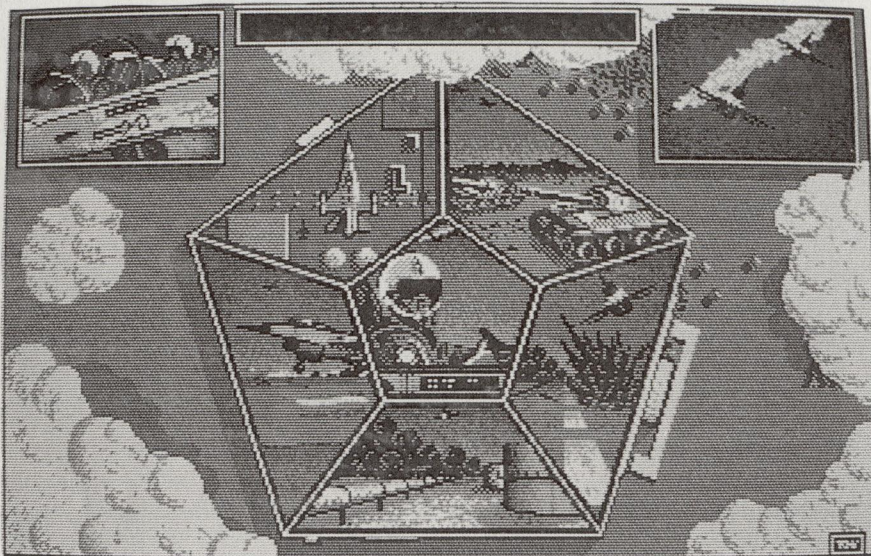

Mission selection

It is daybreak. You join the other pilots in the squadron crewroom to discuss objectives for the day ahead. Tactics, combat manoeuvres, one thing is quite clear – you're all itching to get airborne.

The majority of your flying will be on missions assigned by Tactical Air Command (TAC) with front line operations grouped into the 5 primary roles of the F-16:

- **SCRAMBLE** – air-to-air interception
- **HAMMERBLOW** – offensive counterair operations
- **DEEPSTRIKE** – interdicator strike
- **TANKBUSTER** – battlefield close air support
- **WATCHTOWER** – reconnaissance

Having made your selection, you proceed to the pre-flight briefing for target details and weapon loading.

Now, for all you fighter jocks who want to take the F-16 back to its roots, TAC has a special assignment:

- **GLADIATOR** – one-on-one dogfight

Never mind the SAM's or other "everyday" problems, just get out there and take him out!

And finally .....

- **OPERATION CONQUEST** – multi-mission strategic campaign

Tactical Air Command will not allow novice pilots to command Operation Conquest – the risk is too great! Permission will be granted only after you have completed a successful mission in each of the primary roles at your first squadron.

### Mission tactics

**SCRAMBLE** – air-to-air interception

Hostile aircraft approaching..... no time to lose! Your ground crew have refuelled and re-armed your aircraft, ready for take-off. Don't forget your pre-flight briefing.....

- MiG-29s ..... check!
- 15000 ft ..... check!
- 25 miles ..... check!
- Heading 260 ..... check!

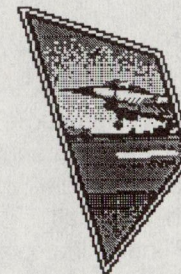

Weather update.... cloudbase 25000 ft, light SW winds

**Objective:** Intercept and destroy hostile aircraft.

To explain fully the principles of air combat would take a book in itself so let's take a look at the five basic elements involved:

(a) **Detection.**

Early warning radar may be able to help you here providing that the

target is not flying too low. Locating and tracking the target is best done with your air-to-air radar but bear in mind that it is a transmitter and will warn the enemy of your approach. The most important factor with detection is "the earlier the better" in order to give you time to plan your attack and to select the right weapon.

"He who sees first, lives longest" – Unknown

### (b) Positioning

Your most effective weapon is surprise. The majority of kills are made without the target even being aware of the attack until it is too late. So, planning your approach is vital. A wide sweeping turn to a position above and behind your enemy will give you maximum "energy" and the upper hand as you begin your attack.

### (c) Attack

Having chosen your weapon commit yourself to the attack. Speed is very important now in order to maintain the element of surprise. Watch for the launch parameters of your weapon and let him have it!

### (d) Engage

Unless you caught your target completely off guard, expect him to make some pretty dramatic evasive manoeuvres. Put him on the defensive by getting in the first shot, then manoeuvre your aircraft onto his tail as quickly as possible. The most well known combat manoeuvres are described in detail in chapter 5 so make sure you've had plenty of practice. Pilots will also tell you that violent uncoordinated turns are often the best way to throw the enemy off your tail, so it pays to not be too predictable!

Things can happen extremely quickly during a dogfight which may only last a few seconds so try to keep a good idea of what your target is doing and where he is – often easier said than done! On top of this you must keep an eye on your altitude and speed – trade off one for the other but don't let your speed drop significantly or you'll end up being the target.

### (e) Break off

The key to success in any dogfight is to remain as aggressive as possible. However, if you suffer extensive damage or see that you are running dangerously low on fuel, it's time to get the hell out of there. How? This could be tricky! Speed and height are what you really need so it's time to select full afterburner and head for home. Unfortunately, your opponent is not going to give up the chase too easily....

### HAMMERBLOW – offensive counterair operations

Our objectives here are to reduce the enemy's ability to strike back. We achieve this by a variety of ground attack missions focussed upon military installations such as:

(a) **Airfields** – runways, hangars, grounded aircraft, control tower etc

(b) **Military bases** – these control the deployment of mobile ground forces

(c) **C-cubed centres** – responsible for intelligence and EW coordination

(d) **Early Warning radar installations**

(e) **SAM and Anti-Aircraft Artillery (AAA) sites**

TAC will select your target and brief you with the necessary details prior to take-off. You may even get a few words of advice about potential hazards in the target area so be ready to take notes.

Your ground crew have refuelled your aircraft and will recommend a suitable weapon configuration if you so request. Don't forget to take at least a couple of air-to-air missiles in case you attract some unwelcome attention.

The most important aspect, as in any mission, is surprise. Here are a few tips so that you give the enemy as little warning as possible:

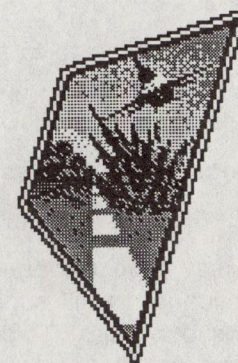

(a) Flying directly to a target will allow the enemy to anticipate your objectives and prepare its defence. So, a common tactic is to plan your flight path with a dramatic change of direction prior to arriving at the target.

(b) Flying low will minimise the possibility of you being tracked by enemy early warning radar. This should reduce the likelihood of enemy interceptors appearing.

(c) Maintain radio and radar "silence" as much as possible. Transmitting to an airfield or using your radar will only make the enemy aware of your presence.

(d) Unless directed to attack a SAM site or EW radar it is best to avoid these at all costs.

"Fly low, hit hard!"

**Objective:** Destroy assigned target(s) and return to base.

### DEEPSTRIKE – interdictor strike

As a key member of our interdictor fighter wing, you will now focus your attention on vital support installations and supply links. Targets of particular interest include:

(a) **Fuel depots** – control fuel supply to airfields & military bases

(b) **Power stations** – supply power to factories

(c) **Factories** – provide essential repair & replenishment

(d) **Bridges** – supply route choke points

Your priorities are clear. Penetrate enemy airspace, avoid ground defences, strike your assigned target and get home as soon as possible. Easy? Don't believe it! These missions need to be planned if you're going to survive. Organise your flight plan carefully – TAC will want to know where to look if you don't make it back! Get familiar with your route

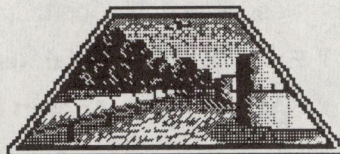

and any possible landmarks that you can use on the way. It's also a good idea to estimate your time to each waypoint – any fuel reserves are going to be essential if you have to divert to an alternative airfield.

Your ground crew will recommend a suitable weapon load or, of course, you may select your own preferred configuration. Above all, keep a watchful eye on your threat warning panel and be prepared for the arrival of enemy interceptors. Just hit that Dogfight button and get in there!

**Objective:** Destroy assigned target(s) and return to base.

### TANKBUSTER – battlefield close air support

Low level ground attack in the heat of the battlefield..... perhaps the most dangerous mission of all. Our intelligence sources have located allied and enemy tank battalions locked in a fierce land battle. Heavy losses are predicted unless you can provide air support – and fast! Now, these guys aren't fooling around down there, they'll shoot at anything that moves! Chances are there will be helicopter gunships providing air cover, backed up by mobile radar-guided SAM launchers. Still willing to volunteer?

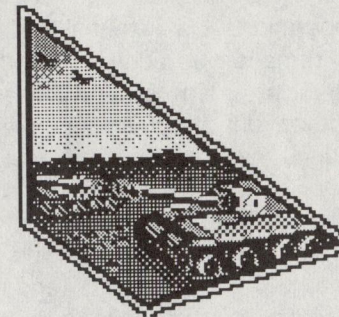

Your first priority will be to down any patrolling gunships so a couple of AMRAAMS should clear the air before you arrive. Use your air-to-air radar in track-while-scan mode to search during your approach – any choppers should be sitting ducks. Your next biggest threat are those mobile SAM launchers so keep an eye on your Threat Warning Panel. Be ready to use chaff and flares. Use your Mavericks to clear the area of SAMs before you arrive. Now, what about those tanks? Take LANTIRN with you if it's available. This box of tricks gives you automatic target acquisition and long range missile guidance for both infra-red and laser-guided Maverick missiles. Survival is the name of the game and if you can pick off your targets from a reasonable stand-off distance so

much the better. However, this is not a perfect world and LANTIRN pods may be in short supply. What now? Well, laser-guided Mavericks may still be used from long range providing that allied infantry in the area are equipped with laser target designators. A last resort is to use your AGM-65D IIR Mavericks by locking-on "visually" using the infra-red zoom lens of the missile. Without LANTIRN however this can only be achieved at relatively close range.

**Objective:** Assist your ground forces to clear the area of all enemy armoured vehicles, SAM launchers and hostile helicopter gunships.

### WATCHTOWER – reconnaissance

For TAC to plan and coordinate its operations it is essential that up to date information be acquired on the movement of enemy ground forces. Despite the advent of spy satellites, reconnaissance missions remain a vital source of intelligence. Present techniques involve two different approaches (a) high speed, high altitude sorties typical of the SR-71 Blackbird and (b) high speed, ultra-low level sorties which is where you come in.....

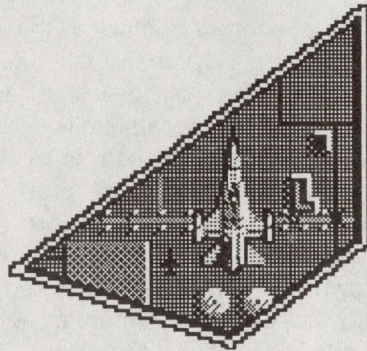

We have recently taken delivery of the very latest high-tech reconnaissance pod – ATARS (Advanced Tactical Air Reconnaissance System) Mounted on your centreline weapons pylon, you can transmit your information in real time via relay stations back to HQ giving literally an up-to-the-minute strategic and tactical update.

A vitally important aspect of any reconnaissance mission is to keep the enemy unaware of where you've been and what you've learned about his movements. So, plan your route carefully, keep yourself as light and manoeuvrable as possible with a minimum self-defence capability, and remember to switch on your ATARS transmitter ONLY when you're over the target area.

**Objective:** Fly over designated areas and transmit data back to HQ

One last point... your ATARS pod is the very best that technology can offer. Don't let it fall into enemy hands..... BRING IT BACK!

### GLADIATOR – two-player dogfight (dual pilots only)

Select this mission for an exhilarating head-to-head battle. Your mission begins at take-off with an air combat weapon load. (No pre-flight briefing necessary, no pilot log active.) Intelligence will inform you of your opponent's location and EW radar will track him during flight if he strays above 500 ft. (See T0 on UFCP) A new mission begin after each kill. (See Appendix 1 for further details)

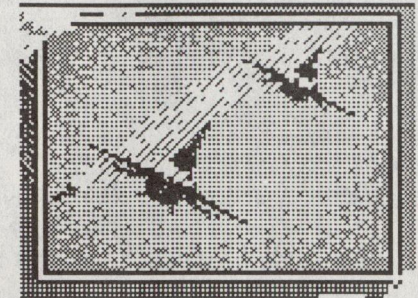

"When you engage you know that only one of you is going home...."

### OPERATION CONQUEST

Telex for you sir....

/ITX 23291XX(TAC)+ 11:45:00  
FROM: TACTICAL AIR COMMAND  
SECURITY: \* TOP SECRET \*  
DIPLOMATIC NEGOTIATIONS  
DETERIORATING.  
INTELLIGENCE SOURCES HAVE  
IDENTIFIED INCREASING MILITARY  
MANOEUVRES.  
STANDBY. . . . .

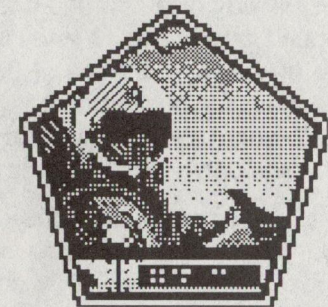

Looks like we could be in for some trouble. Time to get over to the pre-briefing room to assess the situation. Intelligence are expecting an update at any minute.....

/ITX 23291XX(TAC)+ 14:45:00  
FROM: TACTICAL AIR COMMAND  
SECURITY: \* **TOP SECRET** \*  
DIPLOMATIC NEGOTIATIONS FAILED. APPROACHING HOSTILE  
FORCES. RULES OF ENGAGEMENT – \* DEFENSIVE \* DO NOT  
OPEN FIRE UNLESS FIRED UPON. STANDBY. , ,

Time to select weapon load and get refuelled. Check weather conditions – no asking for a calm sunny day now! Potential targets, enemy strengths, be prepared – flight planning is essential. Will the enemy strike?

/ITX 23291XX(TAC)+ 15:37:06  
FROM: TACTICAL AIR COMMAND  
SECURITY: \* **TOP SECRET** \*  
RED ALERT! HOSTILE FORCES ENGAGED.  
ACTIVATE “**OPERATION CONQUEST**”.  
YOU HAVE BEEN SELECTED AS SQUADRON COMMANDER.  
REPORT FOR INTELLIGENCE UPDATE IMMEDIATELY. RULES OF  
ENGAGEMENT – **PURSUE ENEMY SURRENDER**.  
GOOD LUCK!

It is already clear that the enemy offensive consists primarily of low flying ground attack aircraft and highly mobile tank battalions. Their priorities are unknown, but many of our military installations and strategic support services are under threat. Things should become clearer as you learn more about the enemy's movements. Right now the enemy is enjoying air superiority – you've got to change that!

Unlike your other front line duties, **OPERATION CONQUEST** will test your leadership and flying skills throughout a conflict that you hoped would never happen. Day and night, regardless of weather, the enemy advance continues. Without air support the allies will suffer heavy losses and morale will fall. Every ounce of experience will be needed to prevent the enemy from fulfilling his objective – **total defeat of the allies**.

As squadron commander it is your responsibility to anticipate the

enemy's intentions, consider the consequences and act decisively. Under your command is a squadron of allied aircraft capable of flying missions in parallel to your own. Assignment of targets and the effective use of these aircraft is YOUR responsibility during the pre-flight briefing but be prepared to face problems of reliability and shortages of weapons and spares – your ground crew can't work miracles!

Study your strategic display carefully during your preflight briefing. Watch out for any weak links. Essential strategic installations can be repaired, given time and spares, but don't rely on either! Your priorities must remain flexible. TAC has prepared the following brief to assist with formulating your strategy:

**TACTICAL AIR COMMAND**  
**OPERATION CONQUEST – TARGET BRIEF**  
**COMMANDER'S EYES ONLY**

- (a) **Airfields** – These range from minor airstrips with limited support capability to major front line stations. Airfields are heavily defended with SAM launchers and anti-aircraft artillery, not to mention defensive interceptor aircraft. Your priorities here will include any visible aircraft on the ground, and putting the runway(s) out of action.
- (b) **Military bases** – These control the deployment of mobile ground forces, including tank battalions, SAM launchers and helicopter gunships. Destruction of these bases will reduce military coordination and effectiveness. Heavily defended.
- (c) **Factories** – Supply weapons, spares, new military equipment (tanks, aircraft, etc) and provide an essential repair service for all damaged installations. Factories are considered relatively “soft” targets (i.e. not so heavily defended) but not all sites are of strategic importance.
- (d) **Power stations** – Provide power to factories. Because of their strategic importance they are very heavily defended. Output will only cease if all cooling towers are destroyed.
- (e) **Fuel depots** – Supply fuel for aircraft and mobile ground forces.

Relatively “soft” targets but numerous. Their destruction will lead to fuel shortages and reduced mobility for all military vehicles.

(f) **SAM & AAA sites** – These are major ground defence installations offering long range, wide area defence against air attack. Avoid if possible or destroy from reasonable “standoff” range. Do not confuse with mobile SAM and AAA vehicles or shoulder-launched SAMs, all offering short range cover.

(g) **Early warning radar stations** – Responsible for tracking intruder aircraft and scrambling enemy interceptors. Avoid detection by flying below 500 feet, if possible, and take advantage of any “blind spots” midway between stations. Damage will reduce their effective range. Any area without radar cover is extremely vulnerable to air attack therefore EW stations are heavily defended.

(h) **Command, Control & Communication centres** – Responsible for producing intelligence reports, in-flight updates and the coordination of air and land forces. Heavily defended.

(i) **Tank battalions** – Responsible for offensive ground attack on strategic installations. Highly mobile with cover against air attack provided by SAM launchers and/or helicopter gunships. Capable of limited self defence.

(j) **Bridges** – usually referred to as “supply choke points”. The destruction of bridges will have a detrimental effect on the supply of spares, weapons and fuel.

Your experience during OPERATION CONQUEST will be recorded in your personal log under “commanding hours” and “successful campaigns”. As commander you will not “personally” embark upon a flying mission but instead fly as a squadron pilot, under your own callsign. In the event of this pilot being “killed in action”, you will continue flying as another pilot, subject to the availability of aircraft. After successfully completing a campaign you will be offered the opportunity to transfer to a squadron of higher status during the debriefing.

## Weapon Management

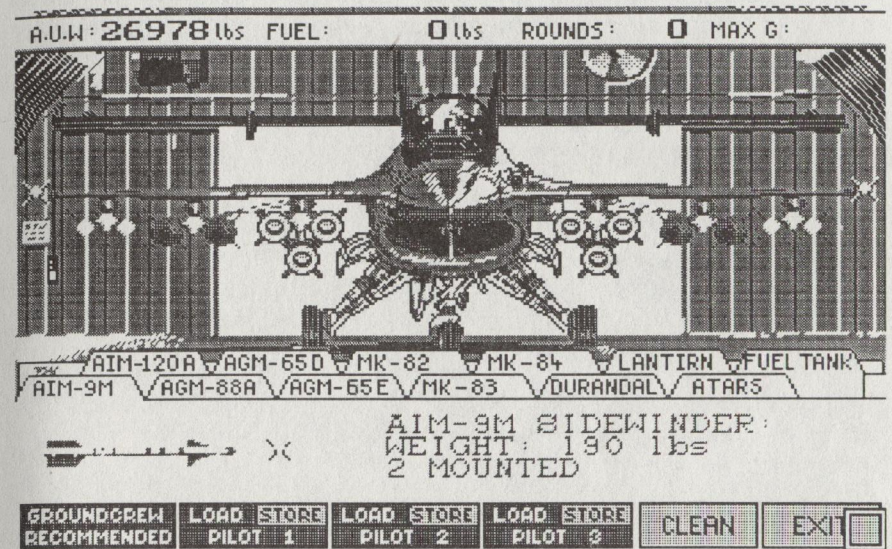

For safety reasons, all weapons are disarmed until you are airborne.

### Air-to-air missiles

You have two types available:

#### Sidewinder AIM-9M

Infra-red (IR)  
Min. range 0.5 nm  
Max. range 11 nm

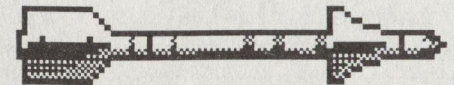

#### AMRAAM AIM-120A

Radar guided  
Min. range 0.5 nm  
Max. range over 30 nm

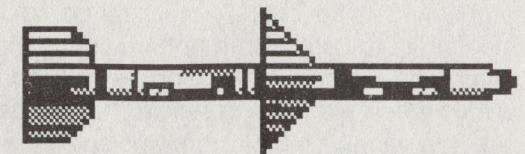

n.b. Max. range at sea level approximately 1/3rd of above figures.

Both of these missiles are **“fire-and-forget”** i.e. you may turn away from your target after weapon release. Although modern technology gives these missiles an **“all-aspect”** capability, they are most lethal when fired at a target either head-on or from astern.

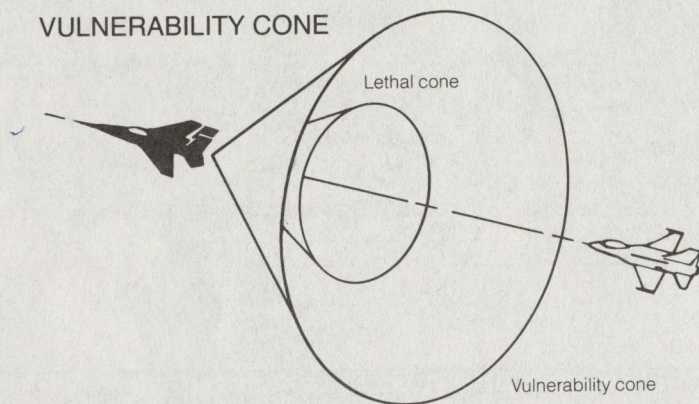

Vulnerability cone & lethal cone

The missile is armed using the weapon selector to bring the AIM9M or AIM120 discrete onto the head up display (HUD). The number remaining is also shown. In the centre of the HUD you will see the ranging reticle, calibrated to approximately 30 mls.

Your attack will begin having located the target on your air radar, probably in **“track-while-scan”** mode. Locking on to your chosen target with the **“designate”** command, you will see the LOCK discrete appear at the bottom left hand corner of the HUD and the target designator box overlaying the target if it is within the HUD field of view. The target will probably still be out of visual range so use the designator box as a steering cue. Look to the bottom right hand corner of the HUD for target range and bearing information. Positioned in the centre of the HUD you will now see the ranging reticle. As you get closer to the target you will see the ranging reticle **“unwinding”** in a counter-clockwise direction.

Once you are within range for the selected weapon you will see the IN RNG discrete appear on the HUD and the weapon will confirm its own lock-on by superimposing a diamond over the target as soon as its launch parameters are satisfied. Manoeuvre until the target is reasonably central on the HUD and launch your weapon.

In the case of the AMRAAM, your radar will have passed tracking information to the homing head up to point of launch. Guidance is automatic thereafter, partly inertial, partly by its own radar. Be prepared for an ECM warning, (see Threat Warning Panel) indicating that your target is trying to confuse the missile with electronic countermeasures. This light will extinguish automatically if either your on-board ASJP (Airborne Self Protection Jammer) or the AMRAAM's internal ECCM (Electronic Counter-Counter Measures) manage to counter the ECM defence.

The Sidewinder homes in on infra-red (heat) emissions from the target – a glowing afterburner being a particular favourite. Don't get confused by the LOCK cue from your radar. The Sidewinder is NOT receiving radar guidance, you are! The missile will confirm its own lock-on with the usual diamond symbol. After launch, the missile will follow the strongest heat source and that could be decoy flares if the enemy pilot has realised what is happening. So, if he tries to fool the missile, be ready for sharp evasive manoeuvres – he may just pass through your gun sights. Also, the missile's inability to distinguish one infra-red source from another makes it unwise to use when allied aircraft are close by or engaged in the same dogfight. Another point worth noting is that infra-red guidance systems do not work well in cloud so don't waste your Sidewinders if you find yourself above the cloudbase. Likewise, zooming for cloud cover may save your life if an IR missile is heading for your tailpipe.

Don't forget that all missiles have a minimum range as well as a maximum. On launch, the missile accelerates very rapidly to its maximum speed and may in fact overshoot and miss the target all together if you are too close. If you find yourself staring down his tailpipe, arm your M61 internal gun and give it your best shot.

## Air-to-ground missiles

### HARM AGM-88A, High speed Anti-Radiation Missile

HARM is a highly effective missile for use against any form of ground radar emitter e.g. early warning radar stations and radar-guided SAM installations. Your Threat Warning Panel includes a "radar tracking" warning light which illuminates whenever you are being tracked by a ground-based air defence radar. Assuming that you have HARM on board, proceed as follows.

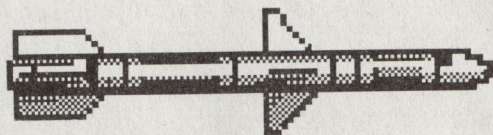

Use your weapon selector to arm the AGM-88 (confirmed on your HUD) and select "Ground Target Ranging" radar mode on one of your multi-function displays. Working in conjunction with your radar, your weapons computer will now restrict displayed targets to ground radar installations, and the radar will automatically select the offending site shown on your Radar Warning Receiver. Lock on to the target using the "target designate" command. Operation of HUD symbology for radar LOCK, target designator box, ranging reticle, IN RNG cue and the weapon lock-on diamond, is the same as for air-to-air weapons.

HARM is the very latest anti-radiation missile, sufficiently intelligent to still find its target even if the enemy's transmitter is switched off after launch. Effective range approximately 4 nm.

### MAVERICK AGM-65

The stores inventory includes the two most popular versions of this highly effective air-to-ground missile:

- **AGM-65D** Imaging Infra Red (IIR)
- **AGM-65E** Laser guided

Both types may be slaved to the LANTIRN target acquisition system, greatly enhancing stand-off range, accuracy and ease of use. Above 30000 ft the weapon becomes unstable.

The **AGM-65D** is by far the most common version. Use the weapon selector to arm the missile, confirmed on the HUD by AGM65D. Next put one of your MFDs into "thermal image" mode. Target acquisition without LANTIRN is by means of the imaging infra-red seeker in the nose of the missile which is used to generate a zoom thermal image on an MFD in your cockpit. Any "hot" target (i.e. tank or mobile SAM launcher) within the missile's field of view may be identified beyond visual range, up to approximately 3 miles.

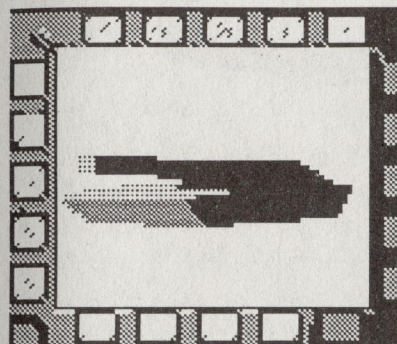
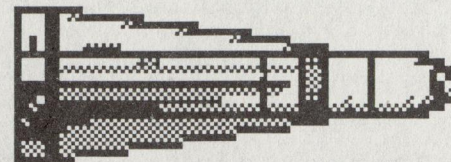

Having identified your target (ensuring that it is hostile and NOT allied!) "pickle" the weapon to lock the homing head to the target. The lock-on diamond will now appear and track your target, within the constraints of the HUD.

The ranging reticle is calibrated to approximately 10nm. Manoeuvre your aircraft to bring the target reasonable central and release your weapon.

n.b. Selecting and designating a target on your ground radar will not necessarily correspond with the "pickled" target. Your weapon is locked on to the target surrounded by the diamond symbol whereas you may have designated a different target for tracking purposes on your radar. The LOCK and IN RNG discrettes will refer to the radar-tracked target only. To summarise:

1. Approach the target area, preferably with your Up Front Control Panel in Waypoint mode. The enemy may detect your approach if you use your ground radar.



2. Have the AGM65D already armed, with an MFD in "thermal image" mode.
3. As soon as you identify a hostile "hot" target, pickle the weapon to lock on and FIRE!
4. Repeat step 3 during your approach but do not stay immediately over the target area – you will be less vulnerable if you fly out and then make a second pass.
5. Once launched, the missile is self-guided.

The **AGM-65E** version uses the tri-service laser tracker, allowing target designation by ground infantry, another aircraft or by the aircraft carrying the weapon. The missile effectively rides a laser beam reflected from the chosen target, making it more accurate and less susceptible to countermeasures than its infra-red equivalent. The missile's biggest advantage however is not being restricted to "hot" targets. In the absence of LANTIRN you will be relying upon ground infantry to illuminate the target using their portable ILS-NT200.

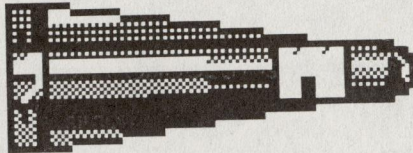

Operation is similar to the AGM65D but lock-on is automatic once the weapon detects an illuminated target. This will be confirmed by the diamond tracking symbol appearing on your HUD.

Advantages include not having to pickle the target manually and knowing immediately that the acquired target is hostile. You do not however get a thermal image of the target. Without LANTIRN your effective range is approximately 3 miles.

Now, adding LANTIRN starts a whole new ball game. As well as providing a night vision capability, LANTIRN allows you to identify and designate targets via your ground radar, both manually and automatically.

The targetting pod contains both infra-red and laser target designators, allowing the system to be used with both types of Maverick. The

infra-red type however is still restricted to "hot" targets. Having armed the required weapon (AGM65D or AGM65E) and confirmed that the LANTIRN pod is active (see UFCP) select your ground radar on one MFD and "thermal mode" on another. LANTIRN will now automatically scan for hostile targets and designate the "most appropriate" on your ground radar display. You may of course manually override this and designate a different target. Range and bearing will be displayed on the HUD as usual, together with the target designator box overlaying the target which will initially be beyond visual range. Weapon lock-on is confirmed with the tracking diamond. After firing your weapon, LANTIRN will lock on immediately to its next prioritised target, leaving you ready to release another weapon. You will soon appreciate the enormous advantages of automatic target recognition and designation when you see how many targets can be destroyed on a single pass. Your effective range is now that of the missile – approximately 11 miles!

To summarise, LANTIRN gives you automatic target recognition and selection from a much greater stand-off range – for both infra-red and laser guided Mavericks – together with night vision. Take it if you can get it!

### Unguided ordnance

n.b. Bombs may not be released at roll angles greater than 60 degs.

### Durandal

By far the most effective weapon for putting runways out of action, the "concrete dibber" is an unguided bomb incorporating brake chute and internal rocket motor (see chapter 8 for further details). Selecting this weapon puts the HUD into CCIP mode (Continuously Computed Impact Point) and is confirmed by the discrete DUR.

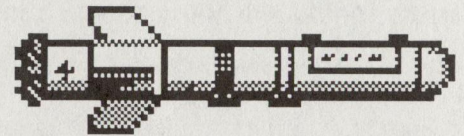

Release the weapon when the aiming reticle is over the desired point of

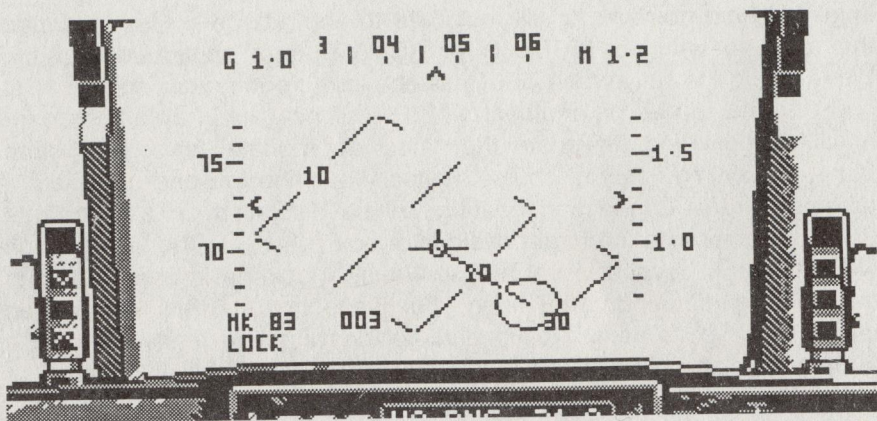

impact, preferably at the intersection of two runways. Although this sounds simple, the best technique of bomb release requires a fair amount of practice:

1. Approach the airfield at approximately 500 kts at below 500 feet.
2. Pull up into a climb, to about 2000 ft.
3. Roll inverted, pulling the nose down to position the aiming reticle at the required impact point.
4. Roll to level flight, release weapon, light the afterburners and get the hell out of there, releasing chaff and flares as you go.

### Mk83 1000lb and Mk84 2000lb bombs

Both types are simple freefall "iron" bombs, capable of giving the enemy quite a headache. Again, use CCIP mode on the HUD with a release technique as described above.

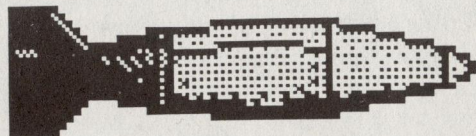

### Mk 82 Snakeye

This particular freefall bomb is fitted with retarding fins that flick open immediately upon release. Dropped at high speed and low altitude, their primary purpose is to "shake off" unwanted pursuing aircraft by exploding in their flight path.

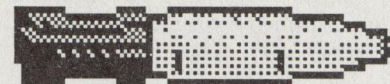

### M61A1 Vulcan 20mm cannon

The F-16 reigns supreme in the close-up dogfight and this is where your choice of weapon will be the internal 20mm cannon. When selected, the ranging reticle (calibrated to 6000 ft) is positioned by the weapon aiming computer to show the bullet trajectory.

Manoeuvre your aircraft to position the reticle over the enemy aircraft and getting as close as possible, open fire with a short burst. Range can be up to 3000ft but is only really effective up to 1500ft. The motto here is to go in close, and then when you think you are too close, go in closer! However, this is easier said than done. At typical combat speeds of 450 to 550 kts, things happen VERY fast so you'll have to keep your wits about you. A dogfight rarely lasts for more than just a few seconds and only one of you is going home.....

Mounted internally on the port side, this six-barrel, high velocity gun fires 100 rounds per second. Bearing in mind that you have only 500 rounds to begin with, its magazine can be emptied in 5 seconds! So, the technique is to fire short bursts, and only when the enemy is in your sights. This is not a video game!

### Other equipment:

#### ATARS – Advanced Tactical Air Reconnaissance System

This new high tech pod provides near-real-time reconnaissance capability. Electro-optical sensors replace conventional photographic technology. Images are digitally processed and transmitted back to HQ via relay stations for immediate interpretation. Operation is straightfor-

ward. Simply switch on the pod (confirmed on your UFCP) to scan the area beneath, simultaneously transmitting the data back to HQ. Remember, however, that any continuous transmission will eventually reveal your position to the enemy. Do not leave the system on for longer than necessary.

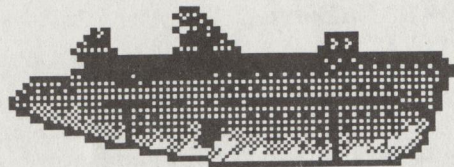

Note: Do NOT jettison an ATARS pod. This would result in the enemy decoding our secure transmission algorithms and stealing the technology.

### External fuel tanks

These may be carried either on the centreline or inner wing pylons. Fuel is consumed equally from the external tanks prior to switching automatically to the internal supply. See the fuel gauge for quantity remaining and the "external tanks empty" light.

TAC regard external tanks as expendable on combat missions but the stores officer is always grateful if you bring them back! External tanks will be fitted only after loading full internal fuel.

### Chaff & flares

Your F-16 is fitted with internal chaff/flare dispensers (ALE-40). The number of chaff and flare cartridges remaining is shown on your weapon status display. Unlike your weapons, chaff and flares do not have to be selected prior to firing.

Chaff is a simple but effective means of self defence against radar-guided weapons and tracking stations. Deploy chaff when you see a threat appear on your radar Warning Receiver.

Flares are self-defence decoys used to "fool" infra-red homing missiles. Use when you see the AAM or SAM warning on your Threat Warning Panel but no indication on your threat warning receiver. To be safe, dispense both chaff and flares and start to manoeuvre aggressively.

## Debriefing

After landing, proceed to the nearest hangar where you will be met by the ground crew. They'll give you a full damage report later. Please observe airfield speed restrictions when taxiing.

So, time to relax a little. Assess the mission. TAC will be waiting to give you a full debriefing.

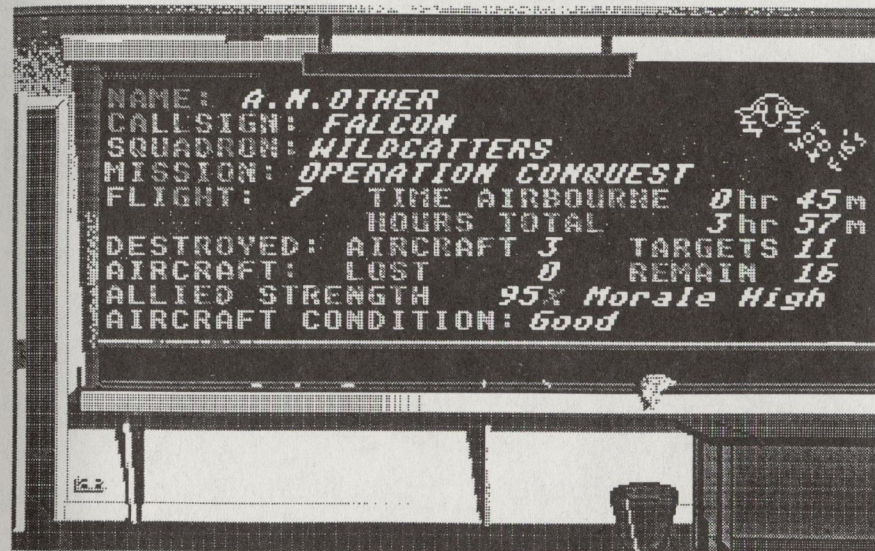

For all "primary role" missions, you will be given your Mission Effectiveness (ME) ratio and your Kill Ratio (KR) for the particular flight. This will not necessarily agree with your overall (ME) and (KR) values which are cumulative and recorded in your pilot's log. For Operation Conquest your debriefing between flights will include information on squadron strength, allied ground forces, and a morale assessment.

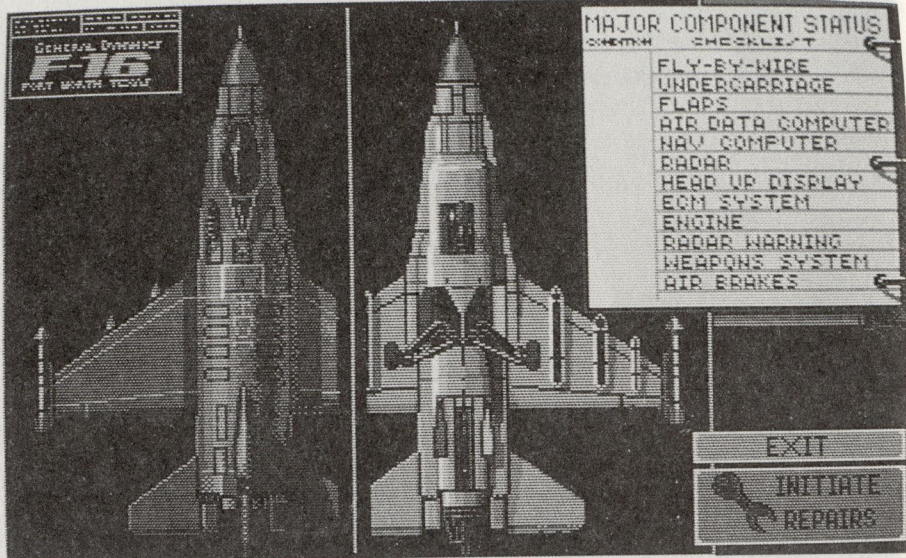

Damage Report

Having digested that little lot, it's time to take a look at the damage report. Your ground crew will give you a report on major component status and will do their best to get your bird back into shape as soon as you initiate repairs. If all systems are not available your only option is to try another airfield. Who said life was perfect?

If you are in the middle of OPERATION CONQUEST and fatigue is setting in, select the "R & R" option to take some well-earned leave. After a couple of days rest you'll be able to continue with the campaign by selecting the "Operation Conquest - Restore" option in the squadron crewroom.

Finally, if you have just returned from a successful OPERATION CONQUEST, TAC will offer you a voluntary transfer to a new squadron of higher status. The choice is yours. Completion of OPERATION CONQUEST in the top level squadron takes a very special kind of pilot. Few have achieved this distinction and been awarded the highest accolade....

## Chapter 5 COMBAT MANOEUVRES

The following combat manoeuvres are categorised as Offensive and Defensive, bearing in mind that during a dogfight the situation can reverse in seconds with the pursuer becoming the pursued.

### OFFENSIVE:

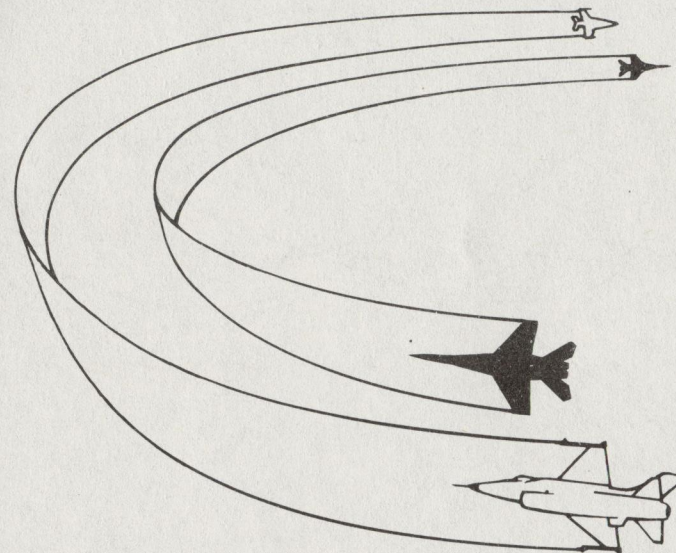

The Lag Pursuit

This is a very simple but effective manoeuvre, used to maintain both speed advantage and initiative during the attack. Follow your opponent as he attempts to break from the attack with a tight turn. By remaining on the outside of the turn radius, slightly astern, you can remain hidden from his field of view. Be ready for an attempt by your opponent to tighten the turn and force you into a spiral dive.

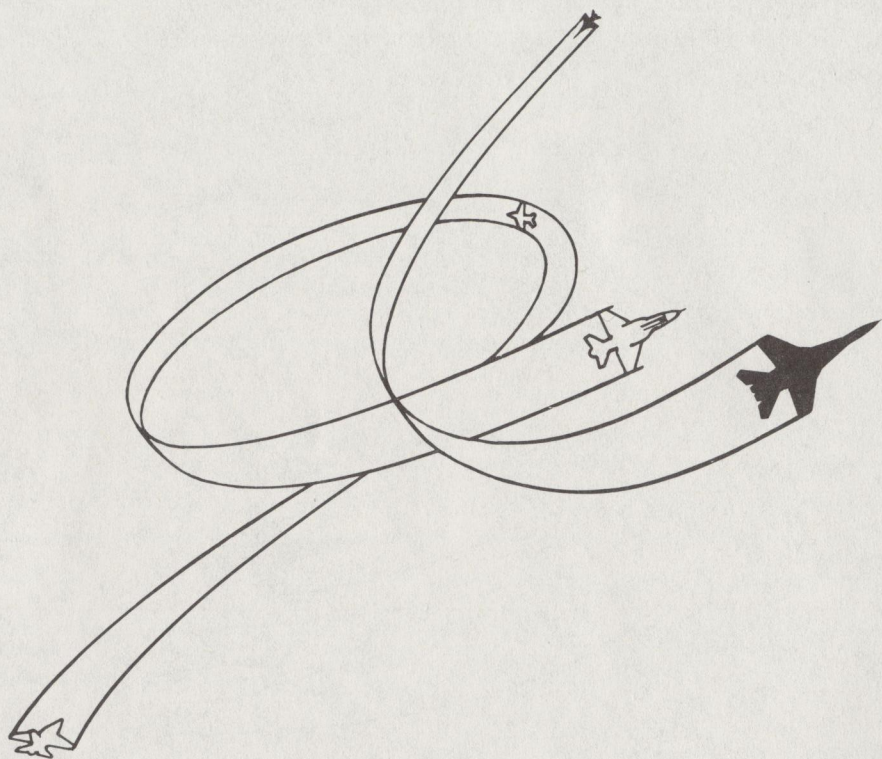

Offset head-on pass

Approaching your opponent from head-on, begin by turning slightly to create an offset to one side. Follow this by turning sharply towards your opponent, passing beneath his flight path as he begins his turn towards you. Maintain this high g turn until you complete a full circle, finally out-turning your opponent to arrive on his tail.

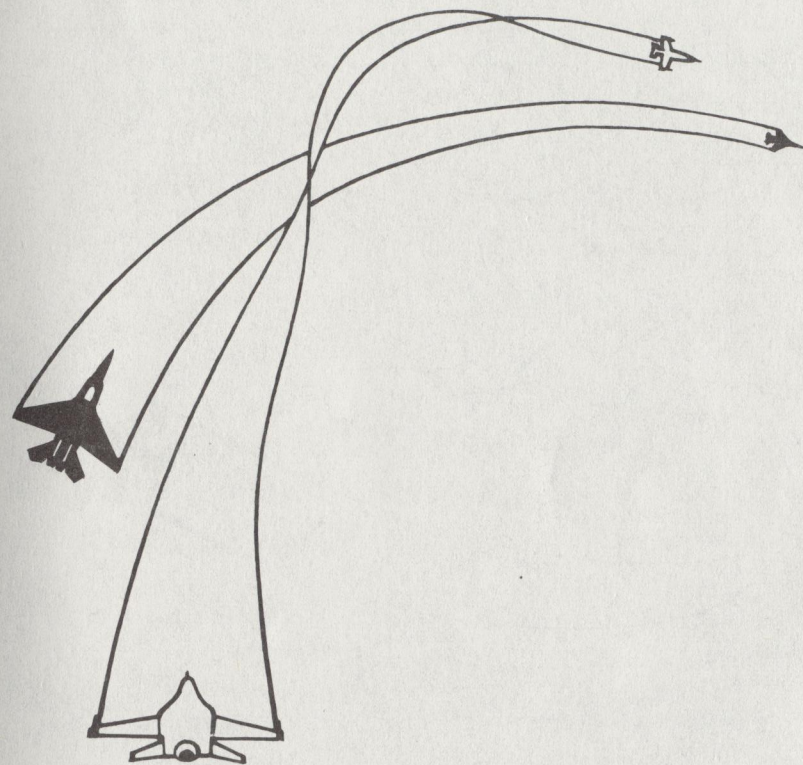

Barrel roll attack

As your opponent attempts to break by turning sharply into the direction of the attack, avoid the overshoot by pulling up hard and rolling away from the direction of his turn. Continue the barrel roll and complete the manoeuvre by pulling in behind your target as your direction of turn reverses.

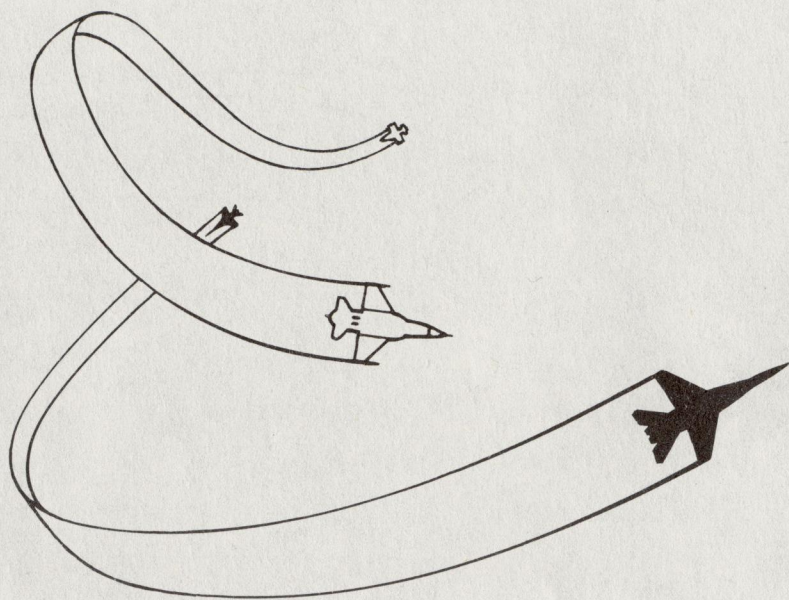

High speed yo-yo

If you find yourself closing in too fast and in danger of overshooting, the high speed yo-yo can be used to trade off speed for height. Begin by pulling up into a climb, rolling on the way up to become inverted at the top of the manoeuvre. As you continue with the pull through, your speed loss will effectively tighten your turn radius allowing you to slide in behind your opponent. The high speed yo-yo is a very difficult manoeuvre to execute correctly, with timing and technique being critical if you are not to reveal your intentions.

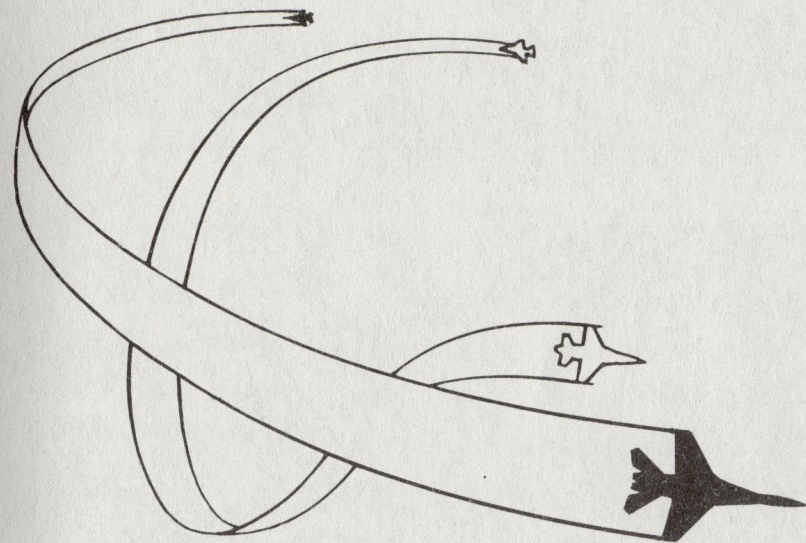

Low speed yo-yo

Use this manoeuvre to gain extra speed during the closing stages of your attack. Trading height for speed, start by diving inside your opponent's turn. Before he counterattacks, pull in behind your target by cutting across his turning circle. The desired closing effect may not be achieved in one execution, in which case repeat the manoeuvre until you are within firing range.

## DEFENSIVE:

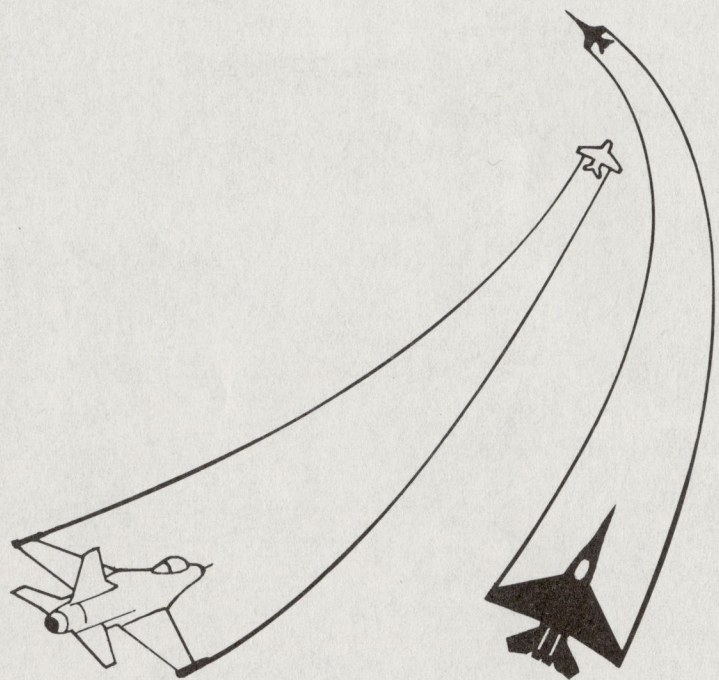

The break

With the enemy closing at your "six" there's no time to waste. Turn as sharply as you can into the direction of the attack thereby creating the quickest "angle-off" between yourself and the pursuer. Brief use of your airbrake may force your opponent to overshoot, allowing you to reverse your turn and move in for the attack. If the enemy is alert, this could be the beginning of the scissors manoeuvre.

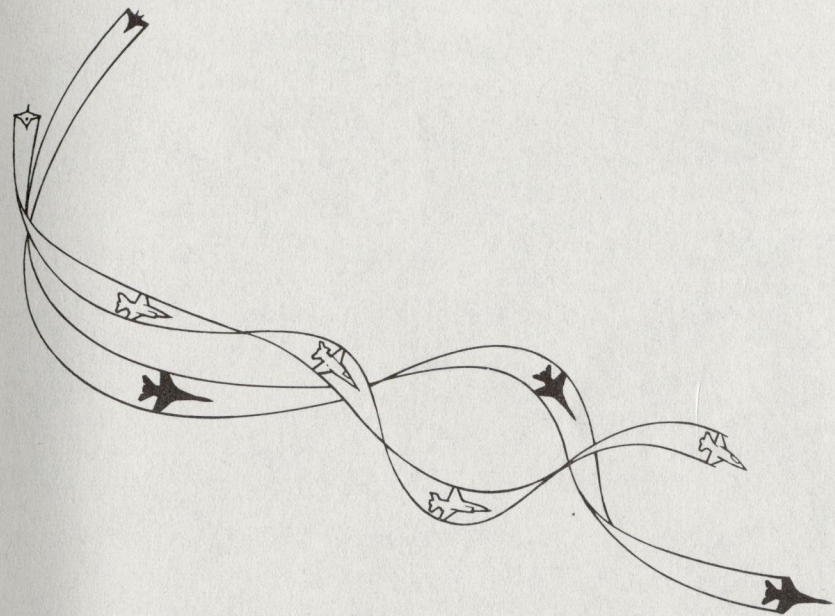

The scissors

Best described as a sequence of turn reversals, the objective is to force the enemy to overshoot and leave you in a firing position. With closely matched aircraft (and pilots!) however, the manoeuvre can rapidly reach a stalemate with each aircraft gaining only a transient advantage. It is strongly recommended that after two reversals some alternative manoeuvre be tried such as the spiral dive.

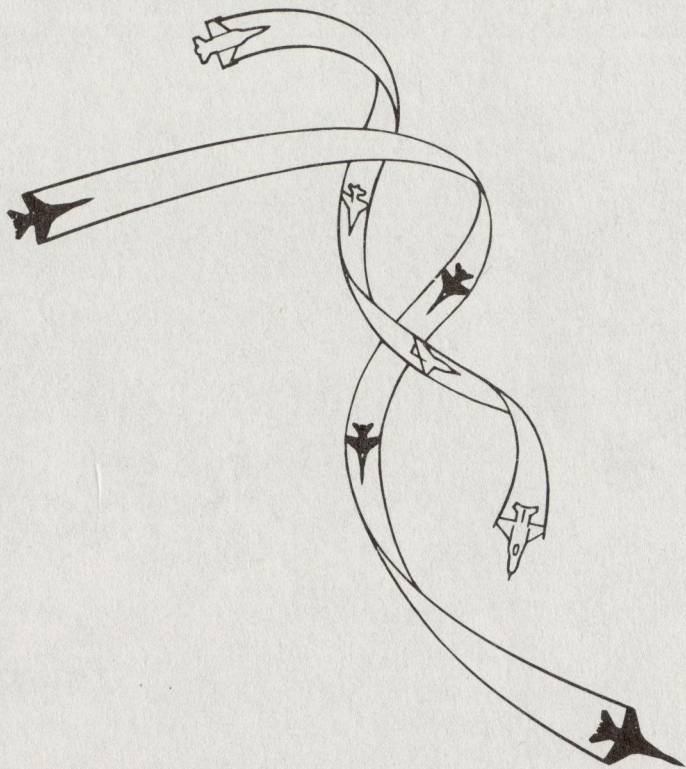

Spiral dive

Often used to shake off a pursuing opponent, this manoeuvre begins by rolling inverted and pulling into a steep turning dive. As the enemy follows you into the spiral, throttle back and extend your airbrake thereby forcing him to overshoot. Open throttle again quickly, turn towards your opponent and pull up for the attack. This manoeuvre should only be attempted at a starting altitude in excess of 15000 feet.

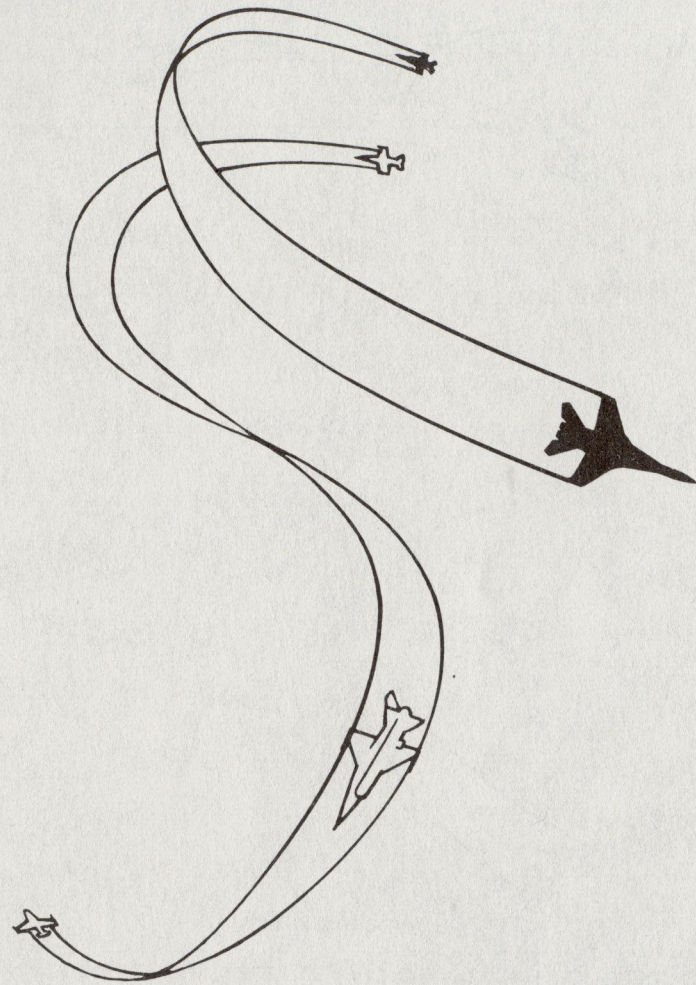

Split S

Sometimes known as the Half Roll, this manoeuvre is commonly used to disengage from the dogfight. Begin by rolling your aircraft inverted and pulling into a vertical dive. Continuing the pull will bring you out on a heading opposite to that of your opponent.



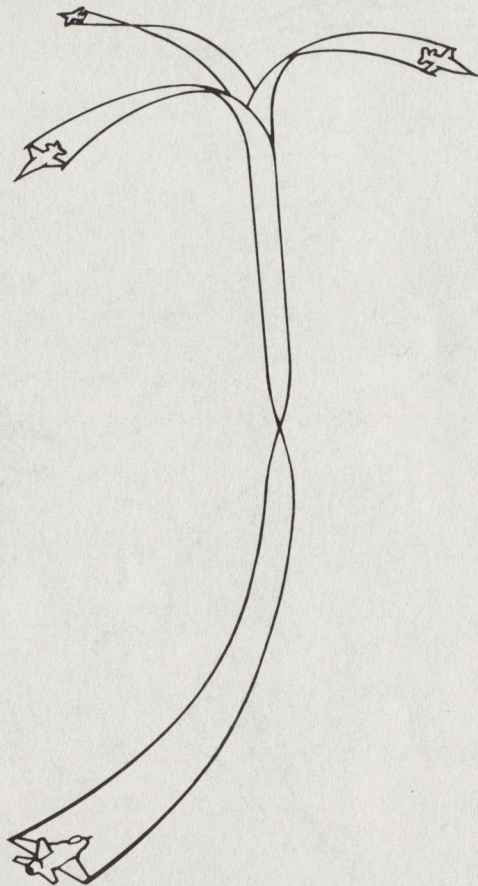

Immelmann turn

Used primarily for repositioning prior to attack, the Immelmann turn uses the vertical plane to change the direction of flight. Open full throttle and pull into a vertical climb. During the ascent roll your aircraft in preparation for a "roll off the top" onto your new heading.

All of the above manoeuvres are common and well documented. In close combat however it often pays to not be too predictable!

### Your aircraft

Flying your F-16 is identical, in principle, to flying any other fixed-wing fighter. However, the F-16 was the first aircraft to be designed, from scratch, utilising the benefits of "fly-by-wire" technology. On-board computers automatically ensure that the pilot cannot overstress the airframe or execute a manoeuvre that would lead to a dangerous flight condition e.g. spin. Exceptional handling qualities and the application of advanced control techniques combine to give a superbly agile aircraft that can be flown aggressively and with confidence.

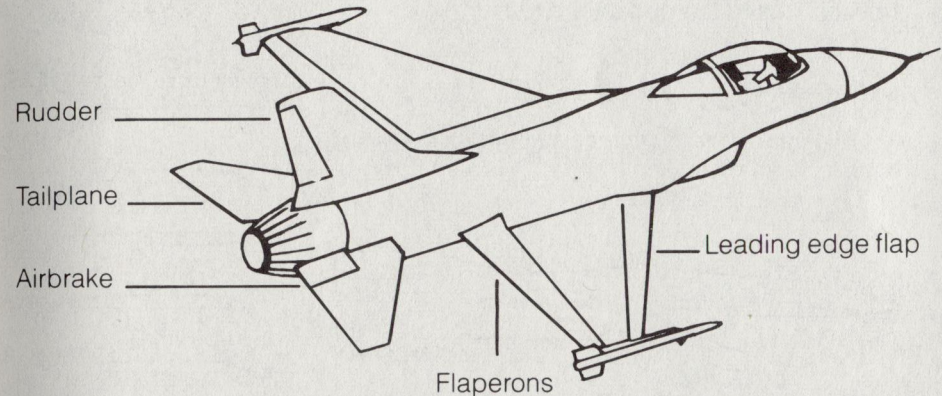

Aircraft controls

To begin with the controls, your inputs are made via the sidestick controller (the F-16's equivalent to a control column) and the rudder pedals. Unlike conventional controls, hand and foot movement is minimal, the controlling factor being the force applied. Your inputs are measured by miniature force transducers linked to the computers of the

quadraplex fly-by-wire control system. Here your demands are “interpreted” and summed with a complex formula of stabilising criteria before finally signalling the control surfaces electronically. The F-16 contains no mechanical links between you and your airframe. The remarkable agility of this “electric jet” is achieved by designing an aerodynamically unstable aircraft and then using the fly-by-wire system to make it flyable. This involves dozens of minute adjustments to the control surfaces being made automatically every second!

Let’s take a look at the control surfaces:

**Flaperons** – a control surface with the combined function of flaps and ailerons. Pressing left or right on your sidestick will drive these surfaces differentially (one up, one down) and your aircraft will roll in the appropriate direction. Relative to you, of course, it appears that the horizon rolls in the opposite direction.

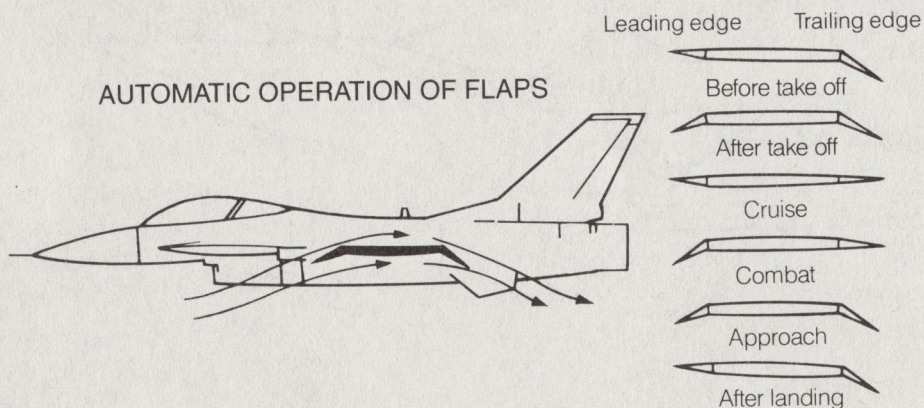

The flaperons are also driven automatically. By changing the camber of the wing very rapidly, the fly-by-wire control system can optimise the wing shape for maximum wing efficiency, stability and control.

**Tailplane** – unlike conventional elevators, modern jet fighters use an “all flying” tailplane whereby the whole surface rotates. Pulling back on the sidestick moves both tailplane surfaces in unison, the effect being to

pitch the nose of the aircraft upwards. Pushing on the sidestick has the opposite effect. At high speeds, the tailplane is used for roll control by driving the surfaces differentially in response to lateral pressure on the sidestick.

**Rudder** – The automatic coordination of controls makes use of the rudder pedals rare, except perhaps for fine heading adjustment during final approach. In fact, during extreme manoeuvres, the rudder is locked out from the pilot so as to avoid sideslipping into a spin.

**Airbrake** – Situated either side of the tailpipe, this control is an efficient means of reducing airspeed quickly. The brake returns to its closed position on release.

### Basic aerodynamics

#### Lift and Angle of Attack

Looking closely at the airflow around a wing we discover an increase in air speed over the upper surface which results in a reduction in pressure. This pressure difference between the upper and lower surfaces gives us the force known as **LIFT**.

The amount of lift depends upon three important factors:

- the speed of the airflow around the wing, determined largely by the forward speed of the aircraft.
- the density of the air. The atmosphere becomes thinner with increasing altitude, resulting in less lift and a higher minimum true airspeed.

- the Angle of Attack (AoA) of the wing. This is the angle between the wing and the oncoming airflow. Lift increases with increasing Angle of Attack, up to the point where the air no longer flows smoothly around the wing. Beyond this the wing departs from controlled flight or

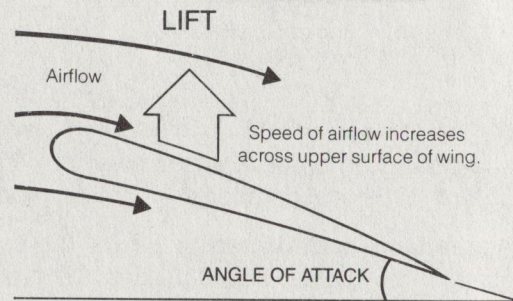

“stalls”. The F-16 fly-by-wire control system automatically limits the AoA to 25 degrees in order to keep the aircraft within its flight envelope. This allows you, the pilot, to manoeuvre as aggressively as necessary without fear of your aircraft going out of control.

### Lift, Weight, Thrust, Drag

Level flight involves the balance of four forces:

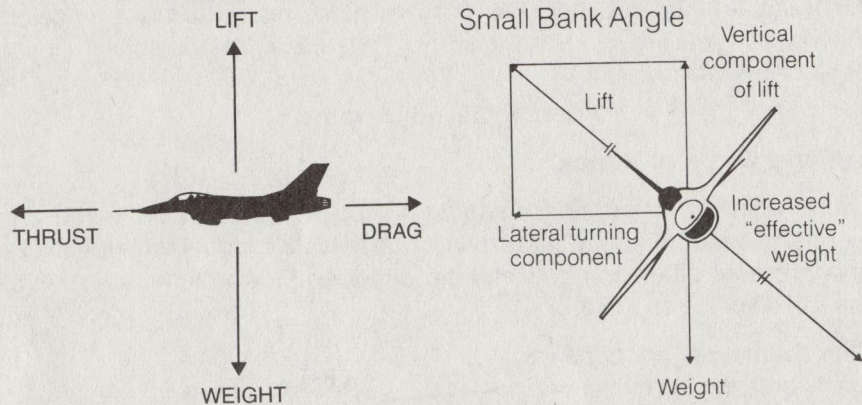

Rolling the aircraft inclines the lift force sideways to give a lateral turning component. In order to sustain the turn the total lift force must increase so that its vertical component remains equal to the aircraft weight.

As the bank angle increases so will the centrifugal “g” force required to sustain the turn. This increases your effective weight and can put enormous stresses upon the airframe and you, the pilot, with a practical short term limit of 9 g. Sustained excessive g force makes it very difficult for your heart to pump blood to the upper parts of your body and you will eventually black out and lose consciousness. The effects of negative g are even more alarming and uncomfortable. An excessive blood supply to the head leads to “redout”, loss of consciousness and damage to blood vessels in the eyes.

### Performance

Performance can encompass many different aspects of an aeroplane but for a combat fighter we are interested in manoeuvrability or turning performance. Three inter-related factors are used to define an aircraft’s capabilities: (i) its ability to pull “g”, (ii) turn rate and (iii) turn radius.

All of these parameters are linked to the aircraft’s speed and bank angle, and will vary with altitude, weapon load and thrust setting. As your speed increases so will your “g” capability and maximum turn rate, accompanied by a tightening turn radius. This favourable picture continues until you reach the aircraft’s “corner velocity” where the best values of “g”, turn rate and turn radius coincide. In the case of your F-16, this is in the region of 500kts. Above this speed you will experience a dramatic increase in turn radius and a reduction in maximum turn rate. So, don’t make the mistake of thundering into a dogfight at supersonic speeds – you will suffer the consequences.

The overall performance of a jet fighter is best illustrated by means of the Flight Performance Envelope. This is a series of curves or “envelopes” plotting true airspeed versus altitude for various values of sustained “g” force.

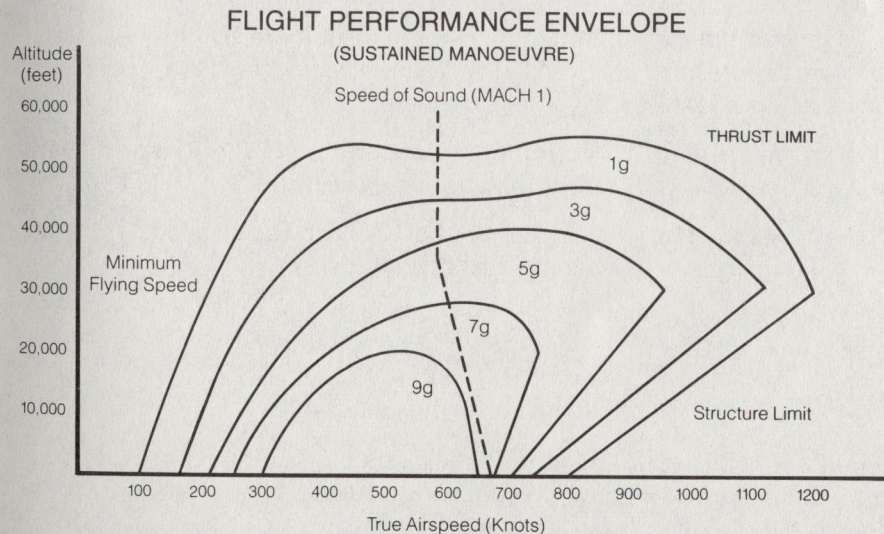

Beginning with the outermost curve, this represents level 1g flight. The left hand side of the curve shows how the minimum flying speed increases with altitude due to the decreasing air density. The top of the curve represents the maximum practical altitude for the aircraft. The curve begins to drop on the right hand side due to thrust limitations and eventually pulls sharply back as we drop to sea level. This is due to a combination of thrust and structural strength limits.

As the level of g force increases, notice how the envelope “collapses”, limiting the maximum 9g capability to between 350 kts and 650 kts at sea level. The curves shown will vary significantly with aircraft weapon loading so interpret the curves with caution. It is also important to distinguish between “instantaneous” and “sustained” manoeuvrability, the first being a measure of transient response or agility and the second (as illustrated above) being the ability to maintain a manoeuvre over a period of time.

For clarification, it’s worth discussing the difference between true airspeed, indicated airspeed and ground speed. True airspeed is simply the speed of your aircraft through the air. This differs from indicated airspeed which is the value presented in the cockpit on an MFD or your HUD. The value is derived from air pressure acting upon a small open-ended tube mounted on the nose of the aircraft (Pitot tube). As air pressure decreases with altitude, your indicated airspeed will also decrease. This leads us to the following important fact:

**“For a given weight, your minimum indicated flying speed will always be the SAME i.e. independent of altitude.”**

Note however that aircraft weight has a significant effect on your minimum flying speed. Here are some typical values:

	Aircraft weight	Minimum IAS
●	17500 lbf	93 kts
●	25000 lbf	111 kts
●	37500 lbf	136 kts

Ground speed is your speed over the ground. In a climb or dive, your ground speed will reduce to zero for vertical flight. Your air data

computer uses **ground speed** to calculate your “estimated time to arrival”.

An additional form of speed readout is your Mach number. This is your true airspeed expressed in units of the speed of sound at your present altitude. The speed of sound reduces from 661 knots at sea level down to 573 knots at 36000 ft (the tropopause) and remains constant above this altitude (the stratosphere).

### Weapon loading restrictions

There are nine weapon loading stations (or hardpoints) on the F-16, two at the wingtips, a centreline station underneath the fuselage, and six underwing hardpoints. Maximum loads for each station are as follows:

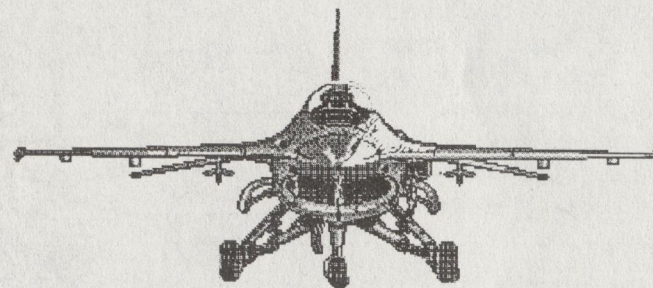

	A	B	C	D	E	D	C	B	A
				9g max					
				5.5g max					
A		425	(193)		425	(193)			
B		450	(204)		700	(318)			
C		2000	(907)		3500	(1587)			
D		2500	(1134)		4500	(2041)			
E		1200	(544)		2200	(1000)			

You will not be permitted to exceed these limits. The fly-by-wire control system will automatically impose the 5.5g restriction when necessary. Additional hardpoints either side of the engine intake are used for carrying LANTIRN and other types of laser/night vision pods.

## Flying clothing

You rely upon what you wear for protection and survival in the hostile environment of air combat so let's take a closer look at your outfit:

**1. Flying suit** – a one piece overall with zip pockets to ensure that loose items are kept secure. The velcro kneeboard patch allows you to keep maps and in-flight notes in place where you can see them.

**2. Parachute harness** – a slim back pack contains your parachute – your final link to a safe landing after separation from your ejection seat.

**3. G-suit** – an inflatable bladder designed to apply pressure around the abdomen and legs during high g manoeuvres. Inflated automatically, it restricts the flow of blood to the lower half of your body, reducing the likelihood of a blackout.

**4. Oxygen mask** – worn throughout the flight, your oxygen mask is strapped on via attachments on your helmet.

**5. Life preserver** – essential if you end up ditching into the sea.

**6. Gloves** – leather-lined and fire proof.

**7. Helmet** – last but by no means least, your helmet. Custom fitted, it is worn over a close-fitting skull cap and incorporates your headset and visor. Combat manoeuvres can get extremely violent, with roll reversals often so sudden that your head makes contact with the canopy. Often highly decorative but never just for show!



## Chapter 7 AIRCRAFT TECHNICAL DATA

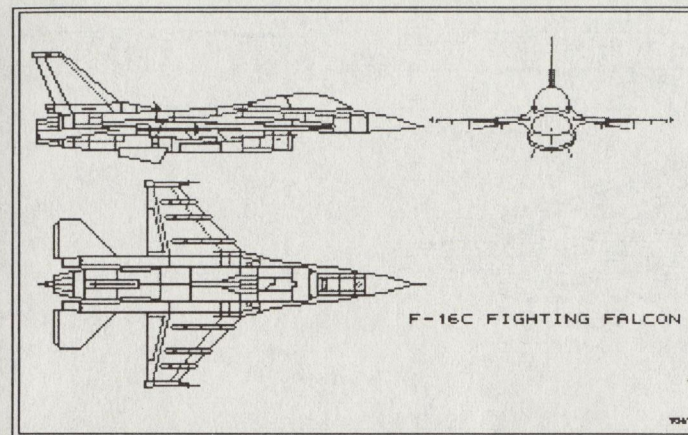

### General Dynamics F16 Fighting Falcon

- Type: Single seat, multi-role fighter

#### Dimensions:

- Length 49 ft 4 in (15.03 m)
- Wing span 31 ft (9.45 m)
- Height 16 ft 8 in (5.09 m)
- Wing area 300 sq ft (27.88 sq m)

#### Weights:

- Empty 16794 lb (7618 kg)
- Max take-off 37500 lb (17010 kg)

#### Power: General Electric F110-GE-100 turbofan

- Rated at 27000lb (120.1 kN) max thrust (reheat)
- 16000lb (71.2 kN) at full military power (100%)

#### Performance:

- Max speed (36000ft) > M2.1
- Max speed (sea level) > M1.2
- Ceiling 50000ft (15250 m)

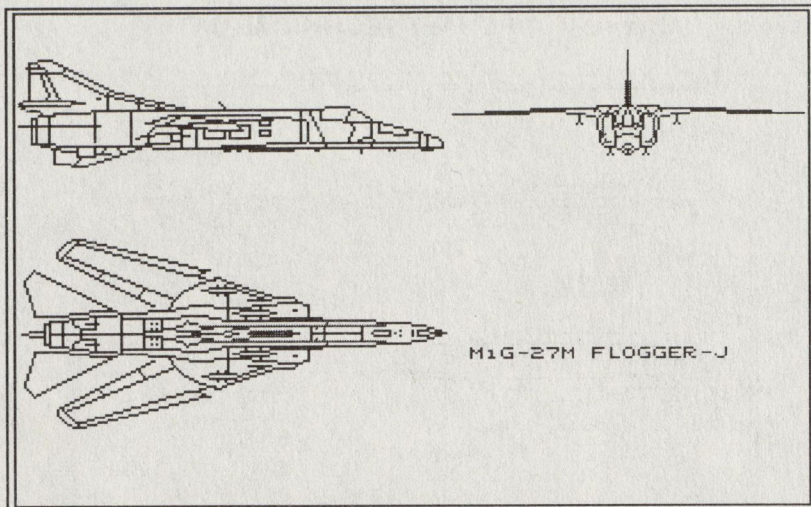

### Mikoyan MiG-27 "Flogger-J"

- Type: Single-seat multi-role fighter

#### Dimensions:

- Length 54 ft 10 in (16.72 m)
- Wing span (swept) 27 ft 2 in ( 8.3 m)
- Height 14 ft 4 in ( 4.35 m)
- Wing area 325 sq ft (30.2 sq m)

#### Weights:

- Empty 25000 lb (11340 kg)
- Max take-off 44500 lb (20185 kg)

#### Power: One Tumansky R-29-300 turbojet

- Rated at 25350lb (113.0 kN) max thrust (reheat)
- 17500lb (78.0 kN) at full military power (100%)

#### Performance:

- Max speed (36000ft) M1.7
- Max speed (sea level) M1.1
- Ceiling 55000ft (16750 m)

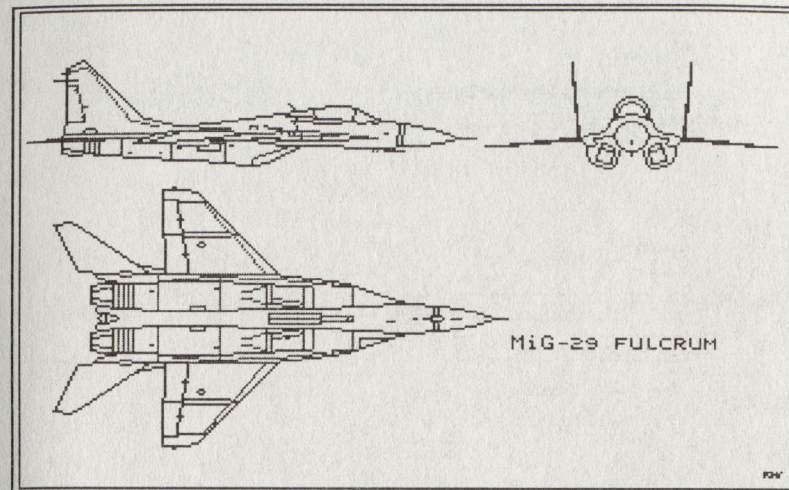

### Mikoyan MiG-29 Fulcrum

- Type: Single-seat all-weather fighter

#### Dimensions:

- Length 56 ft 5 in (17.2 m)
- Wing span 37 ft 9 in (11.5 m)
- Height 14 ft 5 in ( 4.4 m)
- Wing area 400 sq ft (37.2 sq m)

#### Weights:

- Empty 22500 lb (10206 kg)
- Max take-off 41500 lb (18825 kg)

#### Power: Two Tumansky R-33D turbofans

- Each rated at 18300lb (81.3 kN) max thrust (reheat)
- 11250lb (50.0 kN) at full military power (100%)

#### Performance:

- Max speed (36000ft) > M2.2
- Max speed (sea level) > M1.06
- Ceiling 55000ft (16750 m)

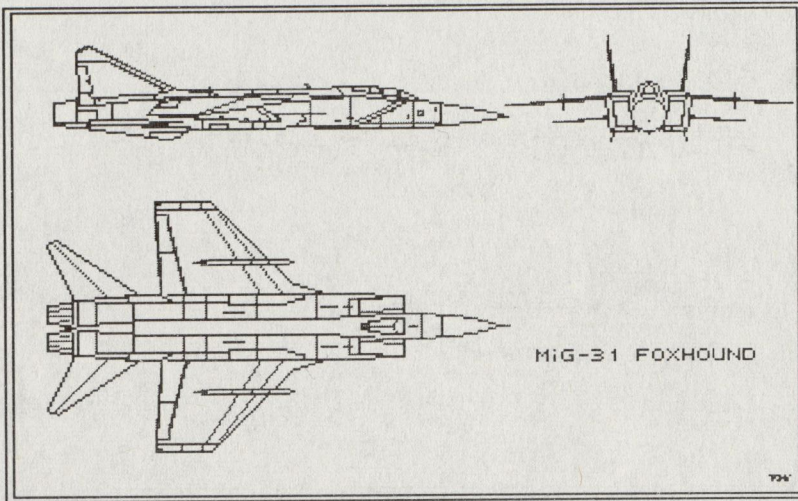

### Mikoyan MiG-31 Foxhound

- Type: Two-seat air defence interceptor

#### Dimensions:

- Length 72 ft 6 in (22.14 m)
- Wing span 46 ft 0 in (14.0 m)
- Height 18 ft 5 in ( 5.6 m)
- Wing area 730 sq ft (68 sq m)

#### Weights:

- Empty 47500 lb (21547 kg)
- Max take-off 90500 lb (41052 kg)

#### Power: Two Tumansky RD-F turbojets

- Each rated at 32000lb (142.5 kN) max thrust (reheat)
- 22000lb (98.0 kN) at full military power (100%)

#### Performance:

- Max speed (36000ft) M2.4
- Max speed (sea level) M0.95
- Ceiling 75000ft (22900 m) .pa

### Sidewinder AIM-9M

- Manufacturer: Raytheon
- Length: 112.2 in (2.85m)
- Fin span: 24.8 in (0.63m)
- Flight time: 60 sec
- Speed: Mach 2.5
- Launch weight: 190 lb
- Range: 11 ml (17.7 km)

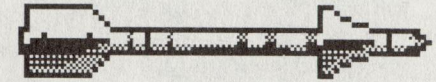

Warhead: annular blast-fragmentation with IR proximity fuse

Notes: Third generation, all-aspect air-to-air infra-red missile with improved motor and ECCM.

### AMRAAM AIM-120A

- Manufacturer: Hughes
- Length: 141.0 in (3.58m)
- Fin span: 25.0 in (0.635m)
- Launch weight: 326 lb
- Speed: Mach 4
- Range: > 30 ml (48 km)
- Warhead: blast-fragmentation type

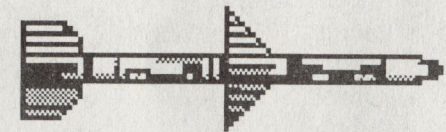

Notes: Inertial mid-course guidance, active terminal radar

### DURANDAL

- Manufacturer: Matra SA,
- Length: 98.43 in (2.5m )
- Fin span: 16.93 in (0.43m)
- Weight: 430 lb (195 kg)
- Warhead: HE 220lb

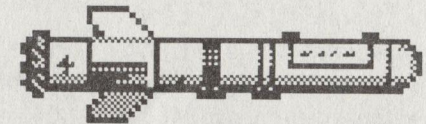

Notes: Released down to 250 ft. Driven straight down by internal rocket motor. Will penetrate over 15 in (0.4m) reinforced concrete, before detonation of warhead.

### MAVERICK AGM-65

- Manufacturer: GM-Hughes
- Length: 98.0 in (2.489m)
- Fin span: 28.3 in (0.719m)
- AGM-65D 485 lb (220 kg)
- AGM-65E 677lb (307 kg)
- Speed: Mach 1.2
- Range: up to 10 ml (16 km) at sea level
- Warhead: Conical charge

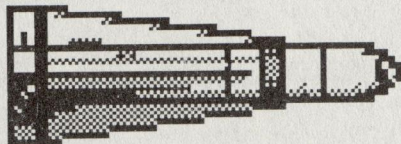

Notes: AGM-65D – Imaging Infra Red triservice seeker. AGM-65E – Laser tracker Both versions may be slaved to the LANTIRN target acquisition pod

### HARM AGM-88A

- Manufacturer: TI
- Length: 164.5 in (4.17m)
- Launch weight: 796 lb
- Speed: > Mach 2
- Range: 4 ml (6.4 km) at sea level
- Warhead: fragmentation with proximity fuze

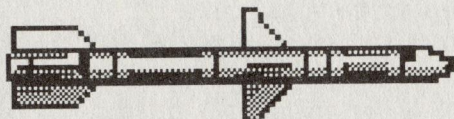

Notes: "Intelligent" anti-radiation missile used in conjunction with Dalmo Victor Radar Warning Receiver, AN/ALR-69

### M61A1 Vulcan cannon

- Manufacturer: General Electric
- Calibre: 20mm Length: 73.8 in (1.875 m)
- Length: 73.8 in. (1.875
- Weight: 537 lb inc. 500 rounds
- Rate of fire: 6000 rounds per minute
- Muzzle velocity: 3400 ft/s (1.04 km/s)

## Appendix 1 One-on-one communications

### Software

Selecting **GLADIATOR** will lead you to the communications set-up screen. Ensure that **BOTH** computers are assigned the **SAME** baud rate. Choose which pilot will be RED LEADER and BLUE LEADER (must not be the same on both computers). Select **TAKE-OFF** to start mission.

Pressing HOLD on either computer will freeze BOTH aircraft. The mission is resumed by pressing Continue on the same computer. Pressing Quit on either computer will abort the mission and return both pilots to the debriefing room.

The simulation will run at the speed of the slowest computer, with adjustments made automatically to maintain real-time.

### Hardware

Connection between the computers is via an RS232 null modem cable.

Pin connections as follows:

	Plug A		Plug B
Pin	2	to	3
Pin	3	to	2
Pin	7	to	7

No handshake lines are necessary. If you have difficulty obtaining a suitable cable, then please call DI on 0276 684959.



## Appendix 2 8 Bit Versions

All screenshots in this manual have been taken from the Atari ST version with occasional highlighting for clarification. All descriptions apply to 16 bit versions of this product. Due to technical limitations, 8 bit versions have been simplified in several areas including, but not limited to, the following:

1. Wire frame graphics are used instead of solid. This has been done in order to maintain as smooth a simulation as possible with a reasonable variety of objects.
2. The two-player option GLADIATOR is not available.
3. Forward cockpit view only.
4. The COMMAND function in OPERATION CONQUEST is not available.
5. Some cassette versions may have simplified menu screens. If you wish to upgrade to a disc version, we offer an exchange service.

Whilst every effort has been made to maximise the authenticity of this simulation, it has been necessary to make approximations due to the technical limitations of your computer and certain information not being in the public domain for security reasons. Our wealth of experience and research material enabled us to make intelligent "guesses" where necessary and most importantly, to ensure that your enjoyment of this product does not suffer.

All squadron names are fictional. Digital Integration reserves the right to publish revised versions of this product in our continuing aim to bring you the very best in the world of simulation.

## Appendix 3

### The Team

**F-16 COMBAT PILOT** has taken over nine man-years to develop. At DI we strive to bring you the best in software, and here's the team that did it:

Concept, design and project manager: **Dave Marshall**

Programming and design:

- **Colin Boswell**
- **Marcus Goodey**
- **Chris Smedley**
- **Paul Margrave**
- **Dave Marshall**

Additional programming support:

- **Rod Swift**
- **Kevin Bezant**

Computer graphics: **Tony West**

Manual by **Dave Marshall**

If you have any comments on this product or suggestions for future ideas then we'd like to hear from you.

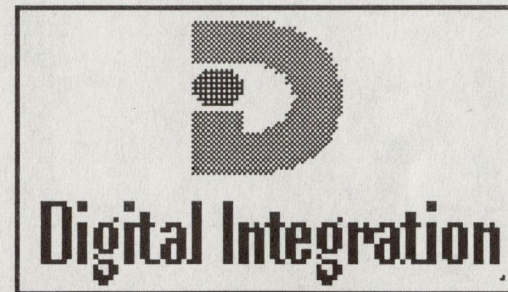

The Real World of Simulation

## Acknowledgements

**Bill Gunston** – for writing the Foreword, helping us during our research, and providing an endless source of contacts to make sure that we got it right!

**Flight International** – for their help with flight test reports and photographic material.

**Salamander Books** – for their kind permission to use the digitised title screen, plus further photographic and research material.

**Patrick Stephens Ltd** – for kind permission to use various quotes from "Fighter Combat" by Robert L. Shaw.

**GEC Avionics** – for information on Head Up Display symbology.

**Patrick Fitzsimons** – for research material on F-16 displays.

Our special thanks to **General Dynamics** for literature on the F-16C and the AFTI F-16, and for the assistance provided by their test pilots.

Our thanks also to the numerous USAF and RAF pilots who made valuable contributions to our research and design of this product.



## Further Reading

We cannot possibly include everything about the F-16, air combat, weapons, aerodynamics etc. in such a short (!) manual. The books listed below are some of those used during our research and design and we strongly recommend them if you would like to learn a little more about the fascinating world of the combat pilot.

Modern Air Combat	Gunston & Spick	Salamander Books
Modern Fighting Aircraft	Doug Richardson	Salamander Books
Aircraft Armament	Bill Gunston	Salamander Books
Fighter Combat	Robert L. Shaw	Patrick Stephens
Flying Modern Jet Fighters	Robert Jackson	Patrick Stephens
Topgun Fighters	Various	Ian Allen Ltd
F-16 Fighting Falcon	Peter Foster	Ian Allen Ltd

All of the above books, plus many more, are available direct from Digital Integration through our mail order service. Please send a stamped, addressed envelope for price details and promotional offers.

**DIGITAL INTEGRATION LTD**  
**WATCHMOOR TRADE CENTRE**  
**WATCHMOOR ROAD**  
**CAMBERLEY**  
**SURREY**  
**GU15 3AJ**

**Tele sales: 0276 684959 ACCESS or VISA**

## GLOSSARY & ABBREVIATIONS

AAA.....anti-aircraft artillery  
AAM.....air-to-air missile  
ACS.....air combat scan  
ADI.....attitude director indicator  
AFTI.....Advanced Fighter Technology Integration  
AGM.....air-to-ground missile  
AoA.....angle of attack  
ASPJ.....Advanced Self-Protection Jammer  
ATARS.....Advanced Tactical Air Reconnaissance System  
AUW.....All Up Weight (aircraft total weight)  
Avionics.....aircraft electronic equipment  
BRG.....bearing (heading required to fly to target)  
Callsign.....nickname used for radio transmissions  
Camber.....curvature of the wing  
CCIP.....continuously computed impact point  
C-cubed.....command, control and communications  
Ceiling.....maximum practical flying altitude  
Cloudbase.....altitude at which you will enter cloud  
CNI.....communications, navigation and identification  
Combat zone.....designated flying area  
Dead stick.....flight after engine failure  
Discrete.....head up display symbology  
ECCM.....electronic counter-countermeasures  
ECM.....electronic countermeasures  
ETA.....estimated time to arrival  
EWR.....early warning radar  
FBW.....fly-by-wire  
g.....weight multiplying factor, units of gravity  
GCA.....ground control approach  
Glideslope.....up/down ILS beam  
GPS.....global positioning system  
GTR.....ground-target-ranging  
GTT.....ground-target-track  
Hardpoint.....weapon loading station  
HUD.....head up display

IAS.....indicated airspeed  
IFF.....Identification Friend or Foe  
IIR.....imaging infra-red  
ILS.....instrument landing system  
Jock.....pilot  
LANTIRN.....Low Altitude Navigation & Targeting Infra-Red for Night  
Localiser.....left/right ILS beam  
Mach.....unit of speed of sound  
MFD.....multifunction display  
MSIP.....Multi-national Staged Improvement Program  
nm.....nautical mile  
NWS.....nose wheel steering  
Pilot's log.....personal flying record  
R & R.....rest and recuperation  
Recce.....reconnaissance  
Reticle.....weapon aiming and ranging symbol  
RNG.....range or distance to target  
RWR.....radar warning receiver  
SAM.....surface to air missile  
Sidestick.....F-16 equivalent to conventional control column  
Sortie.....flight or mission  
STT.....single-target-track  
TAC.....Tactical Air Command  
TAS.....true airspeed  
TFTS.....Tactical Fighter Training Squadron  
TWS.....track-while-scan  
UFCP.....up front control panel  
UHF.....Ultra-High Frequency  
VSI.....vertical speed indicator  
Waypoint.....pre-planned destination on flight route

## INDEX

Aerodynamics.....	82
Airbrake.....	82
Aircraft technical data.....	8,88
Air-to-air missiles.....	58
AMRAAM, AIM120A.....	58
Angle of attack indicator.....	26
ATARS reconnaissance pod.....	66
Attitude director indicator.....	26
Autopilot.....	45
Barrel roll attack.....	72
Break, the.....	75
Chaff.....	67
CNI datalink.....	28
Cockpit familiarisation.....	17
Command key.....	14
Compass.....	34
Damage report.....	69
Data entry panel.....	30
Dead stick landing.....	45
Debriefing.....	68
DEEPSTRIKE.....	51
Demo mode.....	8
Digital artificial horizon.....	22
Durandal.....	64
Eject handle.....	32
Engine rpm indicator.....	27
External fuel tanks.....	67
Failure status panel.....	35
Flaperons.....	81
Flares.....	67
Flight controls.....	8
Flying clothing.....	87
Free flight.....	40
Fuel gauge.....	27
GLADIATOR.....	54

Glideslope.....	24
Ground Control Approach.....	44
Ground speed.....	85
Gun.....	66
HAMMERBLOW.....	50
HARM, AGM-88A.....	61
Head Up Display.....	36
High speed yo-yo.....	73
IFF security code.....	keypad
Immelmann turn.....	79
Indicated airspeed.....	85
Instrument landing system.....	23
Kill ratio.....	8
Lag pursuit.....	70
Landing practice.....	43
Left hand panel.....	33
Loading restrictions.....	86
Localiser.....	24
Low speed yo-yo.....	74
Maverick, AGM-65.....	61
Met Office Function key.....	15
Mission Effectiveness.....	8
Mission key.....	12
Mission selection.....	9,47
Mk 83 and Mk84 bombs.....	65
Moving map display.....	21
Multi-function displays.....	18
Offset head-on pass.....	71
OPERATION CONQUEST.....	54
OPERATION CONQUEST - restore.....	9
Pilot's log.....	7
Performance envelope.....	84
Pre-flight briefing.....	11
Primary flight data.....	22
QUICKSTART.....	4,7
Radar modes.....	18

Radar warning receiver .....	25
Rear view .....	36
Reconnaissance pod, ATARS .....	66
Report key .....	13
Right hand panel .....	34
Rudder .....	82
Scissors.....	76
SCRAMBLE .....	48
Sidewinder, AIM-9M .....	58
Snakeye, Mk82 .....	66
Spiral dive .....	77
Split-S.....	78
System control functions .....	30
TANKBUSTER.....	52
Tailplane.....	81
Take-off key .....	17
Targets key .....	12
Threat warning panel.....	31
Training .....	11
True airspeed.....	85
UHF communications transceiver .....	30
Up front control panel .....	28
Vertical speed indicator .....	27
Vulcan, M61A1 cannon .....	66
Warning lights.....	32
WATCHTOWER .....	53
Waypoint key .....	13
Weapon Function key .....	15
Weapon management.....	58
Weapon selection.....	16
Weapon status display .....	21
Weapon technical data .....	9,92
Weather Key .....	13
Zoom thermal image.....	23



The Real World of Simulation

DIGITAL INTEGRATION LIMITED, WATCHMOOR TRADE CENTRE, WATCHMOOR ROAD  
CAMBERLEY, SURREY GU15 3AJ. TEL: (0276) 684959