

KNIGHTS *of the* SKY

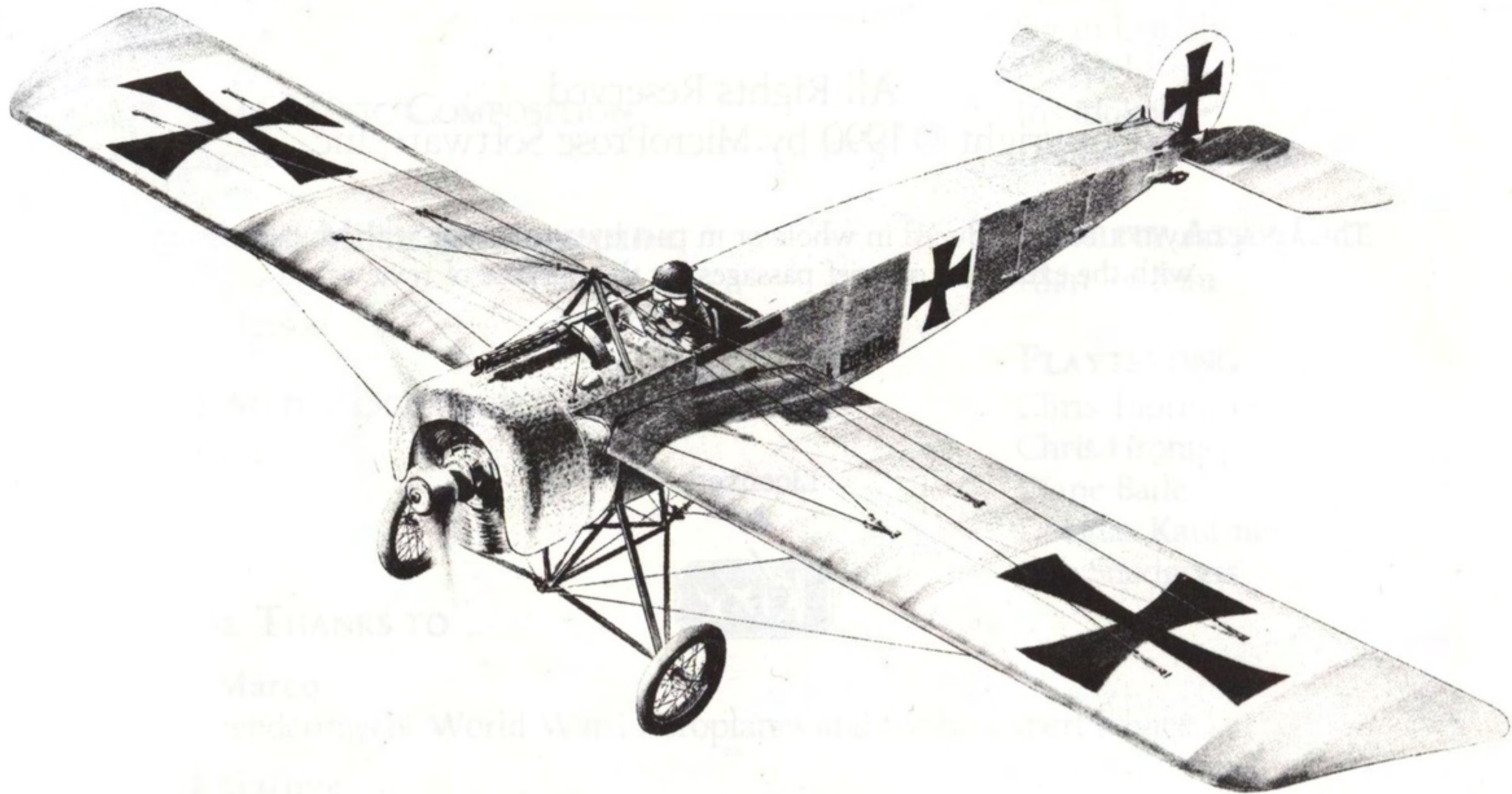

MICRO PROSE

Knights of the Sky™



Joe Kleckner

FOKKER E.III (1915)

MICRO PROSE™
SIMULATION • SOFTWARE

KNIGHTS OF THE SKY

Computer Game

MicroProse Software

180 Lakefront Drive, Hunt Valley, MD 21030

(301) 771-1151

All Rights Reserved

Copyright © 1990 by MicroProse Software, Inc.

This book may not be reproduced in whole or in part by any means without permission,
with the exception of brief passages for the purpose of reviews.

Licensed
By



Knights of the Sky is MicroProse Software's trademark for its game of World War I Aerial Combat

IBM is a registered trademark of International Business Machines, Inc.

Apple and Macintosh are registered trademarks of Apple Computer, Inc.

Tandy is a registered trademark of Tandy Corporation

AdLib is a registered trademark of AdLib Incorporated.

Hayes is a registered trademark of Hayes Microcomputer Products, Inc.

Roland MT-32 is a registered trademark of RolandCorp, USA.

CREDITS

GAME DESIGN

Jeffery L. Briggs

PROGRAMMING

Scott Spanburg
Bill Becker

ART/DESIGN

Jackie Ross

ORIGINAL MUSIC COMPOSITION

Ken Lagace

SOUND AND MUSIC PROGRAMMING

Jim McConkey
Scott Patterson

PRINT MEDIA DIRECTOR

Iris Idokogi

SPECIAL THANKS TO

Joe DeMarco

for his renderings of World War I Aeroplanes and for his expert advice

Frank Garove

for opening his extensive library to the designer

Ken Lagace

for sharing his knowledge of flight

MANUAL

Jeffery L. Briggs

MANUAL EDITOR

Douglas Kaufman

MANUAL GRAPHICS AND LAYOUT

Matt Scibilia
Susan Ullrich
Michael Reis
Iris Idokogi
Desmond Schmidt

QUALITY ASSURANCE

Alan Roireau

PLAYTESTING

Chris Taormino
Chris Hromanik
Diane Baile
Douglas Kaufman
Rob Snodgrass

CONTENTS

Introduction

1. Quickstart	11
----------------------------	-----------

2. Operating Instructions	15
--	-----------

Preliminaries	15
----------------------------	-----------

Hardware Options	15
------------------------	----

Using the Menus	16
-----------------------	----

Squadron Insignia ID	16
----------------------------	----

The Main Choice Menu	17
-----------------------------------	-----------

World War I	17
-------------------	----

Flight Training	17
-----------------------	----

Dogfight Encounters	18
---------------------------	----

Head to Head Play	18
-------------------------	----

Controls, Views, and Instant Replays	19
---	-----------

Simulation Controls	19
---------------------------	----

Views	20
-------------	----

Instant Replays	21
-----------------------	----

Aeroplane Controls and Gauges	23
--	-----------

Aeroplane Controls	23
--------------------------	----

Cockpit Gauges	24
----------------------	----

3. World War I	27
-----------------------------	-----------

Overview of the Game	27
-----------------------------------	-----------

Getting Started	29
------------------------------	-----------

Creating a Pilot	29
------------------------	----

Choosing an Existing Pilot	29
----------------------------------	----

The Ace Status Screen	30
-----------------------------	----

The Home Menu	31
----------------------------	-----------

Standard Options	31
------------------------	----

Special Options	31
-----------------------	----

Information Bar	32
-----------------------	----

The Control Panel	32
-------------------------	----

Missions	33
-----------------------	-----------

Briefing	33
----------------	----

Targets and AA Fire	34
---------------------------	----

Return to Base or Not?	35
------------------------------	----

Becoming "Ace of Aces"	36
-------------------------------------	-----------

Information Screens	36
---------------------------	----

Finding Enemy Aces	36
--------------------------	----

Challenging an Ace	36
--------------------------	----

Accepting a Challenge	37
-----------------------------	----

Scoring	38
----------------------	-----------

Targets	38
---------------	----

Returning to Base	38
-------------------------	----

Promotions	39
-------------------------	-----------

Medals	39
---------------------	-----------

4. Practice Games	41
--------------------------------	-----------

Flight Training	41
------------------------------	-----------

Choose the Opposition	41
-----------------------------	----

Choose the Difficulty Level	41
-----------------------------------	----

Choose Your Plane	42
-------------------------	----

Choose Your Base	42
------------------------	----

Flying in Training	42
--------------------------	----

Dogfight Encounters	43
----------------------------------	-----------

Choose a Plane	43
----------------------	----

Choose an Opponent	43
--------------------------	----

5. Head to Head Play	45
-----------------------------------	-----------

Starting the Game	45
--------------------------------	-----------

Name	45
------------	----

Com Port	45
----------------	----

Baud Rate	45
-----------------	----

Call or Wait	45
--------------------	----

Choose a Plane	46
----------------------	----

Chat Mode	46
-----------------	----

Rules of the Game	47
--------------------------------	-----------

The Score Screen	47
-------------------------------	-----------

6. Using Your Aeroplane	49
How to Fly	49
Takeoff	49
Flying Techniques	49
Landing	51
How to Fight	53
A Watchful Eye	53
Using Your Machine guns	53
Balloon Busting	56
Flying Escort	56
Attacking Enemy Two-Seaters	57
Bombing	57
7. War in the Air 1914-1918	61
The Early Days	61
Birth of the Fighter Aircraft	62

The Fokker Scourge	64
The Race Begins	65
The Somme and Oswald Boelcke	67
Bloody April	69
The New Fighters	71
1918: The End Coms	72

8. The Planes	75
Engines	75
Weapons	77
German Fighters	80
Allied Fighters	86
Fighter Appearance Chart	94
Designer's Notes	97

OVERVIEW OF THE GAME

Knights of the Sky offers a wide variety of game options. There are actually four different gaming situations included: *Flight Training*, *Dogfight Encounters*, *World War I*, and *Head to Head play*.

Flight Training allows you to get in the cockpit of any of the 20 different planes available in the game and fly around the world to any spot you like. You choose the level of danger you want to encounter during the flight.

Dogfight Encounters allows you to choose an opponent with which to fight. You have a choice of 16 historical enemy aces to spar with. As in flight training, you choose the plane you wish to fly from all available fighters. Your chosen opponent will fly a plane of comparable performance.

World War I is an extended game that may last over several gaming sessions. You create a character that competes with the 16 historical German aces for the title of "Ace of Aces." You are given mission after mission in which you encounter minor enemy pilots, and occasionally the competing aces. After each mission you receive information about your competitors from newspapers, gossip, and so on. Using this information, you can trace down where a particular enemy pilot is based and go after him.

Head to Head play allows you to dogfight another human being that has *Knights of the Sky*, a Hayes-compatible modem, and a computer. These encounters are played in matches.

World War I and *Head to Head Play* is where the meat of the game can be found. *Dogfight Encounters* and *Flight Training* are fun and exciting, but you'll probably use them as practice.

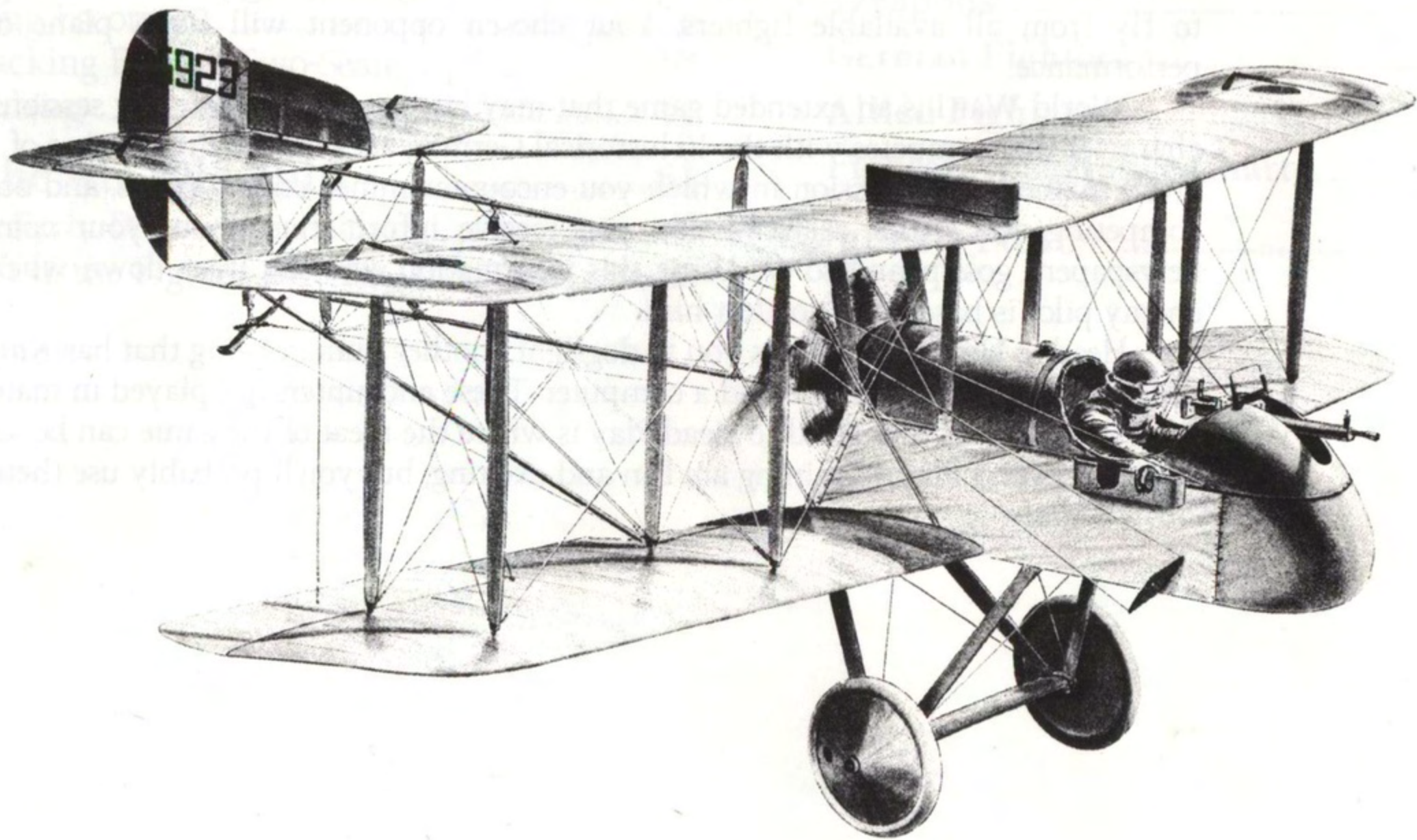

Joe McKeever

deHAVILLAND D.H.2 (1916)

INTRODUCTION

FIGHTING IN FLANDERS

The young flyer walks out of the barracks. It is early dawn. The sky is beginning to lighten over Hunland. It will be another clear, cold day in Flanders.

Looking across the deserted airfield, the breeze wisping his hair, it is almost possible to believe the Boche are defeated and the war is over. But this is not so. Just yesterday evening he almost met his maker when a German pilot suddenly appeared - as if out of nowhere - behind and above the sleek Nieuport fighter he was flying. It was a close thing. In the nick of time he had gone into a power dive that took him below the clouds; in that instant he pulled into a half loop that brought the little biplane back above the cloud and face to face with the enemy. He pulled the trigger and watched as the German plane and the man at the controls were shattered and began spinning toward the ground in a ball of flames.

If his reaction had been a second slower, or if he had failed to notice the fast Albatros descending on his tail, he would have gone down, burning, through the clouds and finally into the wet ground between the trenches.

No, the war is not over - and the quiet, peaceful scene of the airfield, with the gentle breeze, is only an illusion of peace.

There are 10 pilots in the squadron. Only two of them have been with him from the beginning. Casualties have been very high and the Germans are getting new planes - faster Albatros fighters that are probably the best on the front. How much longer can his luck hold? Better not to think about it. Better to think only of the job right now.

In a few moments the flyer will be cutting through the ice cold air at 90 miles per hour, 10,000 feet above the ground. He will be searching the sky for an enemy aeroplane, piloted by a man that speaks a different language. And in the clear, blue sky above the lofty clouds, they will try to kill each other...

INTRODUCTION

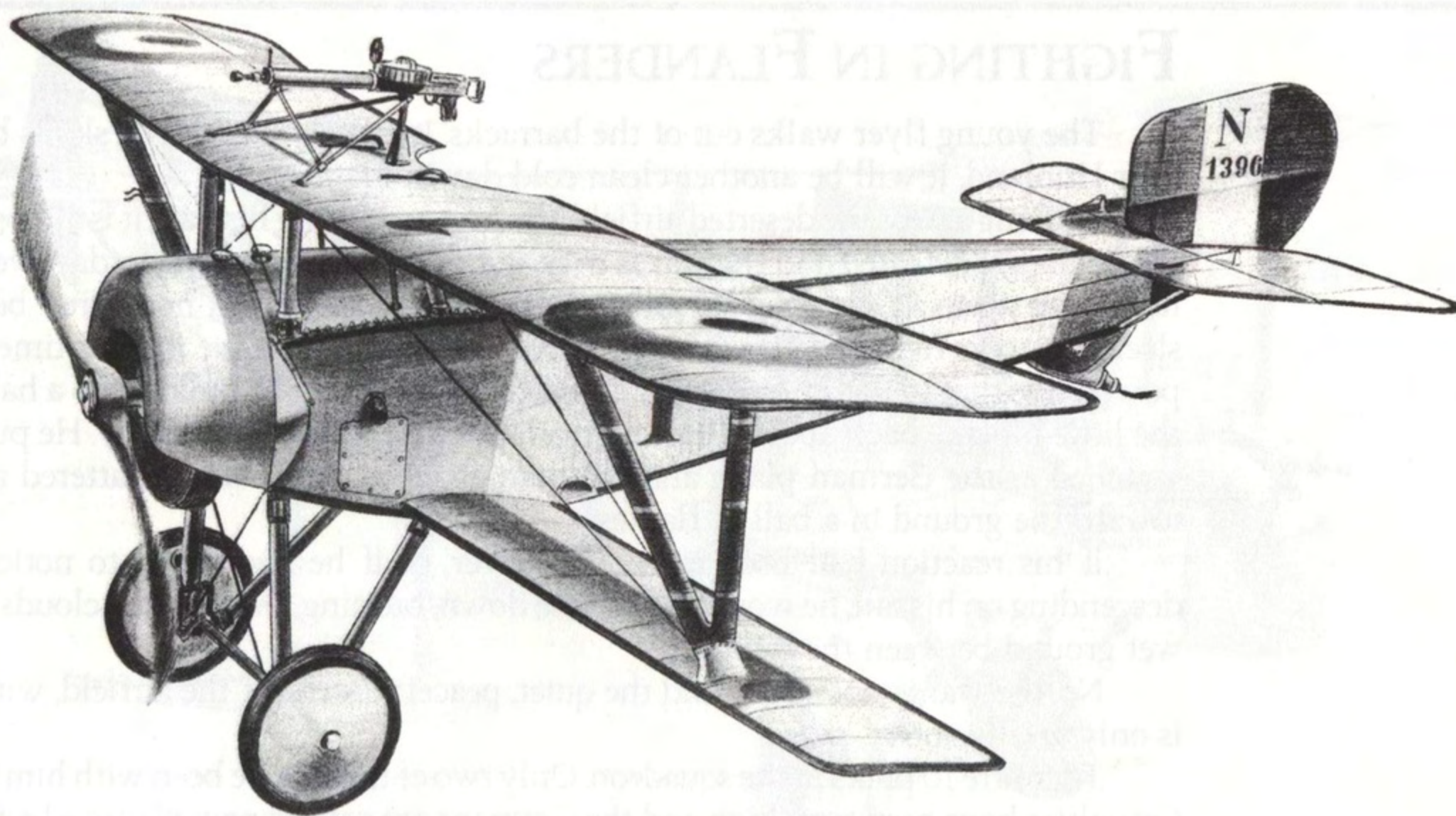

Joe Alcock

NIEUPORT 11.C-1 (1915)

1. QUICK START

If you want to jump right in and begin flying World War I fighters without referring to the rest of the manual, read on; this Quick Start will get you into the air and flying.

It won't help you learn to fly the planes skillfully, nor will it tell you how to play the Historical Game (World War I, page 27), or Dogfight Encounters (page 43). But if you just want to get in the cockpit to see what flying an old aeroplane was like, keep reading.

INSTALL

Install the game onto floppy disks or onto a hard disk (if you have one). See "Installation" in the Technical Insert for details.

LOAD THE GAME

See "Loading Instructions" in the Technical Insert for details and specific commands for starting up the game from disks. You'll first be asked some questions about your computer system. Answer these questions by pressing the appropriate number key. If you have a joystick, we strongly suggest you use it for flying. Note, though, that the keyboard and/or a mouse may also be used.

SQUADRON IDENTIFICATION

You'll be shown a picture of a WWI Squadron Insignia and asked to identify it. See pages 62 to 72 of this manual to see which squadron is identified by the badge you see. If you give the wrong answer, you are automatically sent for a brief training mission in hostile skies; if your answer is correct, you are given the choice of all game options.

FLIGHT TRAINING

When you get to the Main Menu, follow the on-screen instructions and select Flight Training. Choose the following options on the next menus.

- Unarmed Enemies
- Difficulty Level 1

CHOOSE YOUR AEROPLANE

Next you are taken to the Hangar, where you may choose to fly any one of twenty fighters. We suggest you choose the Sopwith Camel for your first flight. To choose the Camel, use the “Next” button until the Camel appears, then select the “Accept Plane” button.

CHOOSE YOUR BASE

Next you are shown a map of the Flanders area of the Western Front. On this screen, you can choose the aerodrome from which you wish to start your training flight.

On the right is a view of the entire map, picturing the trenchline (running north to south through the middle of the map), the main rivers, and the sixteen permanent aerodromes. (This map corresponds to the Operational Map of the Flanders Front also included in this game: for more information about the paper map, see page 28.) A section of the map is boxed, and one of the aerodromes inside the box flashes indicating the currently selected aerodrome. Above this map is the name of the flashing aerodrome.

The large map on the left is a zoomed-in view of the boxed area on the right-side map. This one shows town names, roads, rivers, and the trenches. The currently selected base is marked by the letter “B,” and is near the town named above the small map.

Use the “Next Base” and “Previous Base” buttons to move from one base to another, and the “Accept Base” button to select the base you want. We suggest you select the aerodrome at Dunkirk for your first flight.

YOUR FIRST SOLO FLIGHT

Where You'll Fly

You'll now find yourself in the cockpit of your chosen plane on the field of your chosen aerodrome. As a training exercise, we suggest you do the following:

- Fly to Cassel, where you'll see another allied aerodrome.
- Land at Cassel aerodrome using the *auto-land* ("L" key). See page 23 for details.
- Without turning off your engines, take off again and fly east to the Izjer river.
- Turn North and follow the river to the town of Nieuwpoort.
- Follow the coast or coastal road back to your home aerodrome at Dunkirk.
- Throughout your flight, be on the lookout for enemy aircraft and/or observation balloons - those with German crosses - and shoot them down if you see any.

Tips on Flying

Take-off

The following information is provided to assist you on your first solo flight:

Tap the *Engine Switch* ("O" key) to turn your engines on, tap the *Throttle Up* key ("+") a few times to rev up the engine, then pull back on the stick as you move down the runway to gain altitude (see page 49 for more details).

Fly to Cassel

Probably the best way to navigate to Cassel is to follow the road that leads from Dunkirk south to Cassel. Use your compass and your eyes to help you find the road (for a description of the compass, see page 24).

In-the-Cockpit Map: At any time while flying, you can tap the *Space Bar* to see a map of the area over which you are currently flying. Your position on this map is always directly in the center of the screen.

Land at Cassel

Since this is your first flight, you'll probably want to use the *Auto-Land* (L) to help you land at Cassel. Alternatively, you can try to bring it in "by the seat of your pants" (see pages 51 to 52 for help). Do not switch your engine off after landing; if you do, the flight will end. You may note that while you're on the ground in Cassel, your fuel tank is topped off again.

Fly Down the Izjer River

Once you take off again (see page 49 for help), look at your compass and fly east until you see the river flowing north below you. Turn north, again referring to your compass, and follow the river. At some point, if you look out the right side, you'll see the front lines. If you get too close, you're liable to become the target of anti-aircraft fire (or "Archie" to pilots of the day). This fire looks ominous but is relatively harmless.

Turn West at Nieuwpoort

When you get to Nieuwpoort, turn west and follow the coast or the road that runs to Dunkirk.

Land at Dunkirk

When you reach Dunkirk, you will see the aerodrome just east of the town. Land your aeroplane again and then switch your engine off by tapping the *Engine Switch* (O). You have completed your first flight.

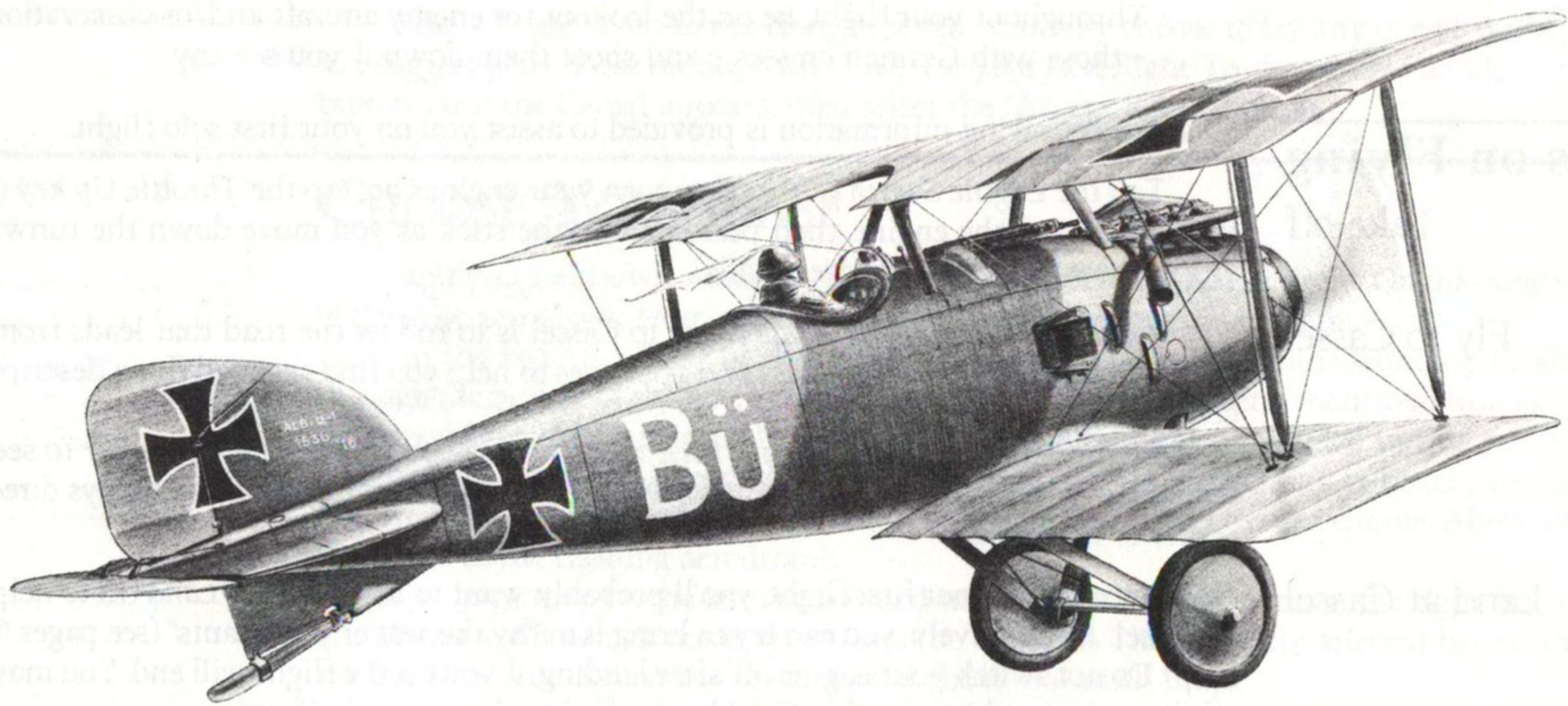

Que ad huc

ALBATROS D.1 (1916)

2. OPERATING INSTRUCTIONS

PRELIMINARIES

Hardware Options

Graphics Options

To start the game, follow the Loading Instructions in the technical insert. When the program starts, you'll be asked questions about your computer system. Use the keyboard to choose options from these initial menus.

VGA/MCGA: Select this option if you have a PS/2, or any other machine with a "video graphics array" board. This provides 256 colors. If you have a PS/2 model 25 or 30, CGA is faster and easier to play, but not as pretty.

EGA: Select this option if your machine has an "enhanced graphics adapter" with 256K of RAM. This option provides 16 colors on any RGB-type monitor (a high resolution EGA monitor is not required).

Tandy 1000: Select this option if you're using a Tandy 1000. This option provides 16 colors. Some Tandy machines also support CGA and/or EGA.

CGA: Select this option if your machine has a "color graphics adapter." This option provides 4 colors.

Sound Options

IBM Sounds: This is appropriate for all IBM PC, XT, AT, and PS/2 machines with no special sound hardware. These have a simple "beeper speaker" so don't expect too much from the music and sound effects.

Tandy 1000 Sounds: Use this only on Tandy 1000 machines which have a special music chip.

AdLib Sound: Use this if you have the AdLib "Music Synthesizer Card."

MT-32 Sound: *Knights of the Sky* supports the Roland MT-32 MIDI sound module with an MPU-401 (or compatible) MIDI interface.

Using the Menus

Knights of the Sky has a host of game options. All these are presented in the form of menus on the screen. You can access a choice from a menu in various ways by using a joystick, a mouse, or your keyboard.

When a menu first appears, one of its options is highlighted. You can move this highlight to other options in the menu using the *controller*. Once the option you want is highlighted, select it by pressing the *selector*.

Using a Joystick

If your controller is a joystick, pushing the stick up and down moves the highlight vertically; pushing it left and right moves the highlight horizontally.

Button 1 is your selector.

Using a Mouse

If your controller is a mouse, dragging the mouse up and down moves the highlight vertically; dragging it left and right moves the highlight horizontally.

The left mouse button is your selector.

Using the Keyboard

If your controller is your keyboard, the up and down arrows move the highlight vertically; the left and right arrows move it horizontally.

The "enter" key is your selector.

Squadron Insignia ID

Before you can play the game you must identify one of the squadron insignias that were prevalent during World War I. On pages 62 through 72 of this manual are drawings that match the images appearing on the screen. You must select the unit designation that matches the insignia shown on the screen.

If you're correct, you'll be given a choice of all game options. If you're wrong, you'll be placed into flight training for a brief excursion.

THE MAIN CHOICE MENU

On the Main Menu, you're given several options that determine what type of game you'll play. By highlighting each option you can read a summary of the features of that game. Following is a more detailed explanation.

World War I (page 27)

World War I allows you to start a career as a young pilot in late spring of 1916. Your goal is to survive the war and have the best record of enemy kills of any pilot on either side.

You'll be given mission assignments on a day by day basis. If you're successful you'll receive citations and awards for your efforts. If you continually carry out orders, you'll be promoted in rank and eventually gain the power to decide where your squadron is based.

After you've shot down your fifth enemy plane, you gain the title of *Ace*. As your career progresses, the careers of other fliers - enemy and friendly - are progressing as well. Sooner or later, you'll find that in order to become the best of the best - the *Ace of Aces* - you must meet the top enemies in single combat.

You'll read newspaper articles, gossip at the local pub, go to dinner parties, and chat with your mechanic. From these sources you'll learn where enemy Aces are based and, therefore, where you must go to find them. In some instances, a jealous enemy competitor will directly challenge you in an attempt to end your career; in other circumstances, you may find it necessary to issue a

challenge to an enemy Ace that is doing too well.

Flight Training (page 41)

Flight Training allows you to fly any of the 20 fighters in the game in an environment of your choosing. You'll have the choice of five levels of flight difficulty, and whether there are active enemies or not.

Flight training is a good way to get familiar with the various aeroplanes and what they are capable of doing. We suggest that beginners use Flight Training to try out all the neat views and weapons, do some sightseeing, and get familiar with the performance of the planes. You should try some loops, rolls, banking turns, and so on, before trying the other games.

MAIN MENU

PROUD TO FIGHT

World War I

Flight Training

DogFight Encounters

Head to Head

Exit Game

Practice flying any one of the great fighters of World War I without the threat of enemy fire or dogfighting.

Choose an option, then press selector.
Pressing Alt-Q at any time will end the game.

Dogfight Encounters (page 43)

Dogfight Encounters allows you to fly any of the fighters in aerial combat against an enemy pilot of your choice.

You'll be shown a portfolio containing the names of 16 enemy aces. By using the "Next" and "Previous" buttons on this screen you can select the pilot you wish to encounter.

Head to Head Play (page 45)

Head to Head allows you to dogfight with a human opponent. If you have a modem and a friend that has a modem, or if you have two computers and a direct cable hook-up, you can fly any of the fighters against another human.

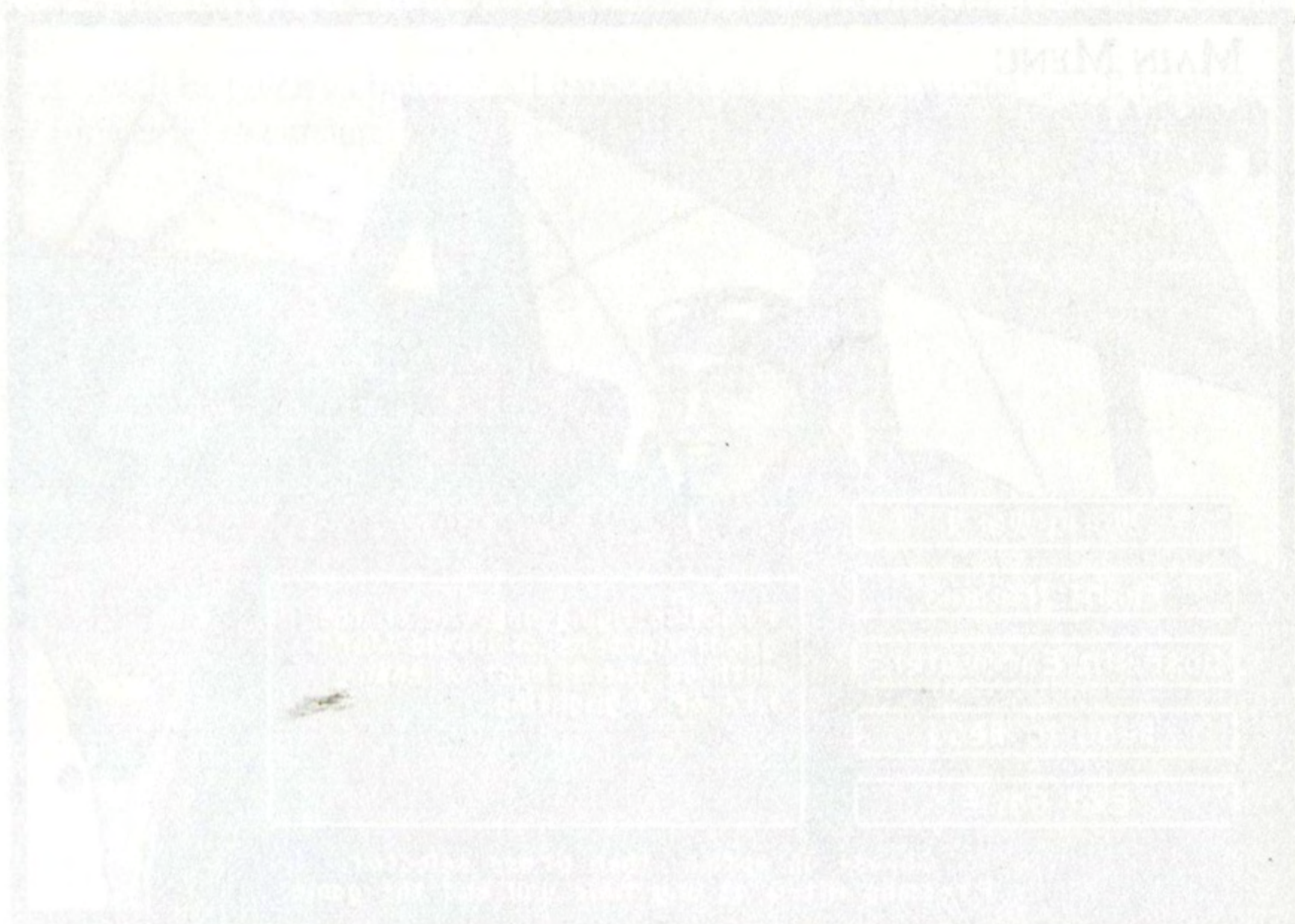

CONTROLS, VIEWS, AND INSTANT REPLAYS

The following is a description of keyboard controls that are functional while flying your aeroplane. In parenthesis is the IBM key that accesses the control. In addition, the gauges in the cockpit are also explained.

Simulation Controls

Control Stick (J, K, or M)

This is a computer simulation of flight in the early twentieth century, and you, the pilot have options and views available to you that the pilots of yesteryear did not enjoy. To varying degrees you control aspects of the very environment in which you're flying.

The control stick you use to fly your plane can be either a joystick, a mouse, or the cursor keys on your keyboard.

Knights of the Sky allows you to switch controllers before or during a flight by the simple press of a key. You can activate your mouse by pressing the "M" key, your keyboard by tapping the "K" key, or your joystick by tapping the "J" key. To make sure your joystick is properly calibrated, give it a brisk, 360° stir immediately after tapping the "J" key.

We strongly recommend that you use a joystick to fly your aeroplanes because you get a much better feel of what it was like in the old days - it is intuitively correct.

Automatic Instant Replay on/off (Alt/R)

Ordinarily, *Knights of the Sky* automatically shows an instant replay of combat situations in which you shoot an opponent out of the sky, or in which you are shot down. You can turn this feature on and off by tapping Alt/R.

Detail Adjust (Alt/D)

This control successively toggles scenic and terrain features off. If you have a slow computer and do not need to see the rivers or roads for navigation - say, during a dogfight - you may turn graphic detail off to speed up play.

There are 5 levels of detail. Each time you tap Alt/D, you move to the next level, and more ground features are removed. In level 5, your plane and the enemy is about all that's left. If you tap, again you return to level 1 - full graphic detail.

Sound Adjust (Alt/S)

This control toggles sound effects on or off while flying.

Pause (Alt/P)

This control immediately freezes the action. To resume play, tap any key. Some computers have a special "pause" or "hold" key. Depending upon the internal design of your machine, this key may also work.

Note: During Head-to-head games (see page 45), the pause key doesn't work!

Quit (Alt/Q)

This control immediately ends the action and returns the machine to DOS. No information about any of your accomplishments is saved to disk, so any new scores made since you last started to fly are lost.

Accelerate Time on/off
(Alt/A)

If you use this option, time passes twice as fast as normal. Accelerated time is useful when you're flying long distances. However, use it at your own risk because enemy pilots can sneak up on you twice as fast as normal. Tapping Alt/A again returns the simulator to normal time.

Town Names on/off
(Alt/T)

This control allows you to toggle the town names on and off when you are viewing your in-flight map (accessed using the Space Bar, see Map, page 23), allowing you to see the road net more clearly.

Views

Knights of the Sky offers you a wide variety of points of view while you're flying. You can easily and quickly jump from inside the cockpit of your fighter to a point of view outside the plane. From inside the cockpit, you can look to the left or right, front or back. There are even a number of views that help you find a sneaky enemy aeroplane, or help you drop bombs more accurately.

In the Cockpit Views

These views are from inside the cockpit looking out. This is your "normal" point of view, the view from which you start all flights.

Front (1): This is the normal in-the-cockpit view. From here you see the control panel of your aeroplane. When engaged in a dogfight, this is your most advantageous position, for from here you can see through the gunsight so your machine gun fire is much more accurate.

Back (2): If you want a quick, wide angle view to the rear of your plane, press the "2" key. You can then see the tail of your plane and the surrounding area.

Right (3): This is a view out the right side of your cockpit. This may be useful in various circumstances such as when you're turning to land at your aerodrome or when there are several enemy planes in the area.

Left (4): This is a view out the left side of the cockpit.

Out-of-the-Cockpit Views

As an aid to learning flight maneuvers and to aerial combat, a variety of external viewpoints are provided. In all of them you're out of the cockpit looking at your plane and/or the enemy.

Remote Control (F1): This is a particularly exciting view designed to help you understand how your plane responds when you use the controls. Whenever you press the "F1" key your viewpoint freezes in your current position while your plane continues. You'll continue to track your fighter and when it gets far enough away, your view will zoom to follow it. This is particularly useful for practicing aerial maneuvers such as loops, "Immelman turns," and wingovers.

Tactical (F2): This view is for dogfighting. When you press the "F2" key, you're placed at a point in space that allows you to see both your fighter and the closest enemy plane. The enemy aircraft is always in the exact middle of the screen. If you tap the "F2" key again the view centers on the next enemy, and so forth. If there's not a known enemy plane in the area, this view is identical to the slot front (F5) view.

Reverse Tactical View (Shift/F2): This is the opposite of the tactical view. It shows the closest enemy plane in the foreground and your plane in the background. Subsequent taps of Shift/F2 show the next enemy, and so on. This is useful for seeing an up-close view of the planes your opponents are flying. (You may decide not to tangle with this one...)

Bombing View (F3): This is an aid in making bombing runs. It places your point of view to the rear and above your aircraft. From here you can see ground objects in front of your plane and your plane's shadow. When you release a bomb, the screen follows the bomb throughout its descent and explosion, then puts you back in the bombing view.

Chase Plane (F4): Here you're positioned in a "chase aircraft" that follows a short distance behind your fighter. As your aeroplane accelerates it "runs away" from the chase plane; as the fighter slows down the chase plane "overtakes" it. This view is very dramatic, but is not very useful for dogfighting or teaching purposes.

Slot Front (F5): Here you're also positioned behind your fighter, but unlike the chase plane, the line of the horizon remains level so you can clearly see the degree of pitch and roll your aeroplane attains as you control its flight. This is an excellent view for learning the most effective and efficient flight maneuvers.

Slot Right (F6): Here your viewpoint is from the left side of the plane, looking right. Your fighter is in the center of the screen, and you can see a large area to the right.

Slot Left (F7): Here your viewpoint is from the right side of the plane, looking left. Your fighter is in the center of the screen, and you can see a large area to the left.

Slot Back (F8): Here your viewpoint is from the front of and slightly above the plane, looking back. Your fighter is in the center of the screen, and you can see a large area to the rear.

Slot Down (F9): Here your viewpoint is from above the plane, looking down. Your fighter is in the center of the screen, and you can see a large area below.

Slot Up (F10): Here your viewpoint is from below the plane, looking up. Your fighter is in the center of the screen, and you can see a large area above.

Zoom and Unzoom View (Z and X)

You have the option of zooming your point of view in closer or moving it back. Zooming in gives you a better view of whatever is on the screen. Zooming out moves you farther away, but gives a wider view of the area. This can be useful when dogfighting.

Instant Replays

Knights of the Sky automatically shows an instant replay of combat situations in which you shoot an opponent out of the sky, or in which you are shot down. (You can turn the automatic replay feature on and off by tapping Alt/R.)

Additionally, you can see a replay of the last few seconds of your flight at anytime by tapping the *Replay Key* (R).

When one of these situations occurs, the action stops and you see a menu of options including, *Forward View*, *Reverse View*, *Predator View*, *Trailer View*, and *Continue Game*.

Forward View Replay

If you choose *Forward View*, you'll see the last few seconds of your flight from above and behind your aeroplane.

Reverse View Replay

The point of view of this replay depends upon the circumstances.

- If you are watching a replay of an air battle in which you or another aircraft were shot down, the *Reverse View Replay* shows the encounter from the point of view of the victim – either you or your target.
- If you are watching a replay as a result of tapping the *Replay Key* (R) the point of view is from in front of and above your own plane, looking back.

Predator View

The point of view of this replay is a little like the remote control view; you watch the action from a stationary point in space. It always centers on the victorious plane – either you or your opponent. If you are replaying as a result of tapping the *Replay Key* (R), the point of view centers on your plane.

Trailer View

This is a very exciting view from which to watch the action. It centers on the victim in a dogfight or your plane in a normal replay. Try it, you'll like it.

Continue Game

If you select this option, the game continues from the exact moment the replay ends and returns to the exact same view (cockpit or exterior) that you were in before the replay began.

Instant Replay (R)

You can see an instant replay of a segment of your current flight at any time. While flying, tap the "R" key and you'll be shown a replay of the last few seconds of your flight.

AEROPLANE CONTROLS AND GAUGES

Aeroplane Controls

Control Stick

Fighter aeroplanes in the early days of flight were relatively simple machines; they had few controls other than a flight stick and rudders, a rudimentary throttle, and a trigger to fire the machine guns.

If using a joystick: Pulling back on the stick causes your plane to pitch up and gain altitude; pushing forward does the opposite. Pushing the stick to the right causes the plane to roll right and results in a right turn; pushing left does the opposite.

If using a mouse: Dragging the mouse back causes your plane to pitch up and gain altitude; pushing it forward does the opposite. Dragging the mouse to the right causes the plane to roll right and results in a right turn; dragging left does the opposite.

If using the keyboard cursor keys: Pressing the down arrow causes your plane to pitch up and gain altitude; pressing the up arrow does the opposite. Pressing the right arrow causes the plane to roll right and results in a right turn; pressing the left arrow does the opposite.

Auto-land (L)

If you're playing at difficulty level 1, 2, or 3, you can use auto-land to get your plane back on the ground (see Landing, page 51).

Engine Switch on/off (O)

To start the engine, tap the "O" key. When the engine is running, tap the "O" key again to shut it down.

Map (Space Bar)

You can look at the operations map that you carry at all times by tapping the "Space Bar." This map shows the area of the front in which you're currently located, with you at the center. Alt/T toggles town names on and off.

Throttle Controls

Max Throttle (Shift/+): This opens the throttle to its maximum level.

Min Throttle (Shift/-): This closes the throttle to its minimum level.

Throttle Up (+): This opens the throttle a little.

Throttle Down (-): This closes the throttle a little.

Fire Machine guns (Selector 1)

Firing the machine gun(s): If you're using a joystick, press *button 1* to fire your machine gun; if you're using a mouse, press the *left mouse button*; if you're using the keyboard, press the "enter" key. You can fire single shots by tapping the button or key, or you can fire continually by holding the button or key down.

Unjamming the machine gun(s): Sometimes your machine guns jam, preventing them from firing. You can attempt to un-jam them by tapping the "U" key. See Jams, page 55, for more details.

Drop Bombs (Selector 2)

If you're using a joystick, press *fire button 2* to release a bomb; if you're using a mouse, press the *right mouse button*; if you're using the keyboard, press the "Delete" key. Each tap of a button or key releases one bomb; careful though, the most you ever have is four.

Cockpit Gauges

Your cockpit may seem barren by today's standards. If you're a real pilot, or at least familiar with MicroProse's other flight simulators like *F-19* or *F-15*, then you may be surprised by the simplicity of your *Knights of the Sky* cockpit.

Altimeter

In the bottom center of your cockpit is the altimeter. It has two needles, one red and one white. The red needle indicates thousands of feet of altitude while the white one indicates hundreds of feet.

Air Speed Indicator

The large dial in the upper right of the cockpit is the airspeed indicator. It is a simple speedometer that measures the airspeed of your aeroplane. The position of the needle indicates your current speed. The numbers are read in multiples of ten, so if the needle indicates a speed of 8, you're actually traveling at 80 miles per hour.

Tachometer

The large dial on the left is the tachometer. It indicates the current performance of the engine measured in revolutions per minute (RPMs). The numbers on the dial are read in multiples of 100, so if the needle indicates 15, your propeller is actually turning at 1500 RPM.

Fuel Gauge

Your fuel gauge shows how much fuel you have in your tank. The taller the bar that rises from the bottom of the gauge, the more fuel you have. If the bar disappears from the bottom of the gauge you're out (or very nearly so) of fuel.

Compass

In the upper middle of the cockpit is your compass, indicating the direction in which you're traveling. The letters N (north), E (east), S (south), and W (west) appear within the compass window. If N is in the center, you're traveling north, if N is a little left of center you're traveling north by northwest, and so on.

Slip Indicator

In the lower right side of the cockpit is the slip indicator. It is an air bubble in a tube filled with water, much like an ordinary carpenter's level. It indicates if your plane is slipping. If the bubble is left of center, your aeroplane is slipping to the right; if it's right of center, your aeroplane is slipping to the left.

Usually it's dangerous for your aircraft to slip; a slip can quickly develop into an uncontrolled spin. It's almost always best to keep the bubble in the center of the gauge at all times.

Ammunition Counter

This digital read-out beneath your fuel gauge indicates how much machine gun ammunition you have remaining. It simply counts down each time a round is fired.

COCKPIT

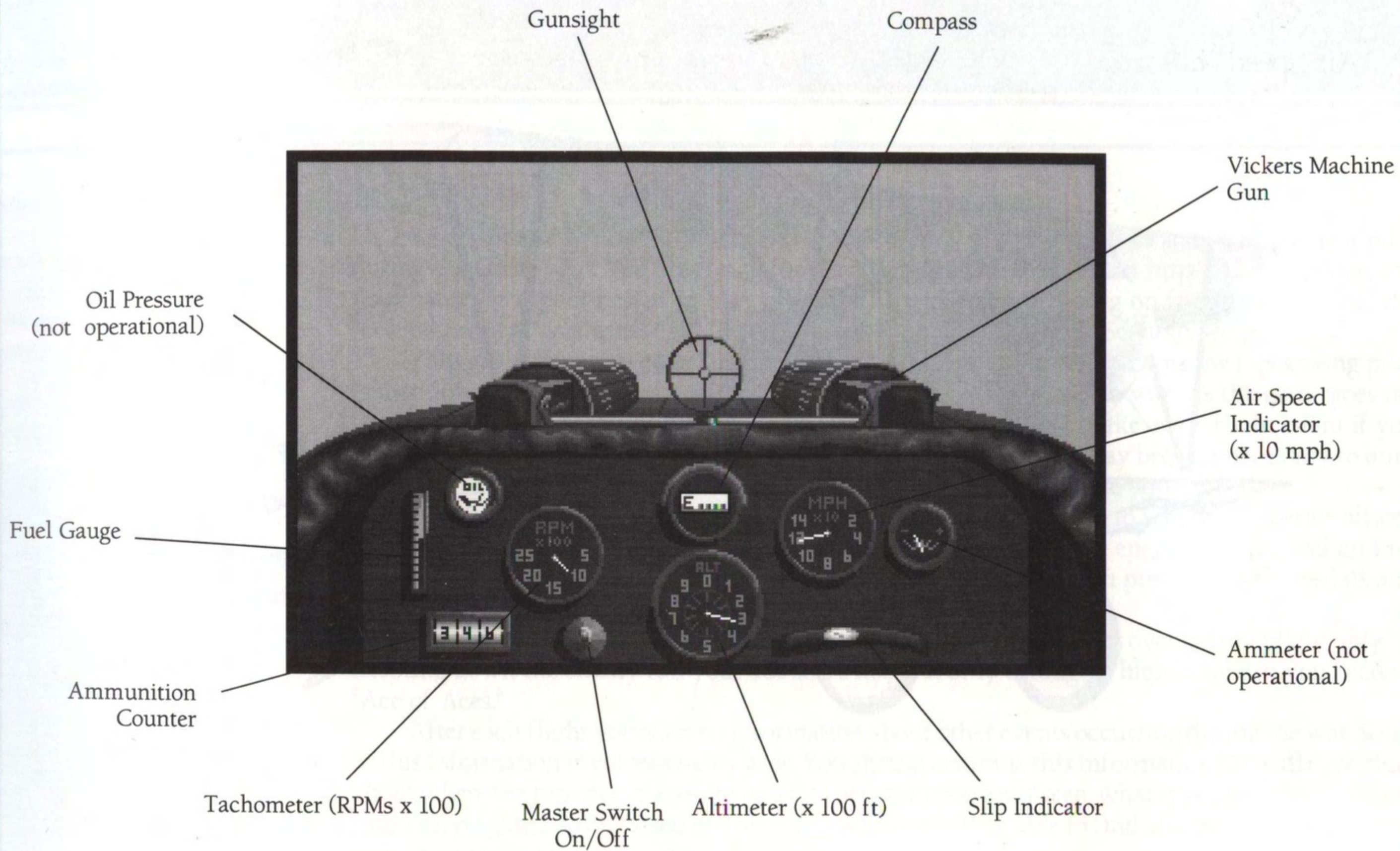

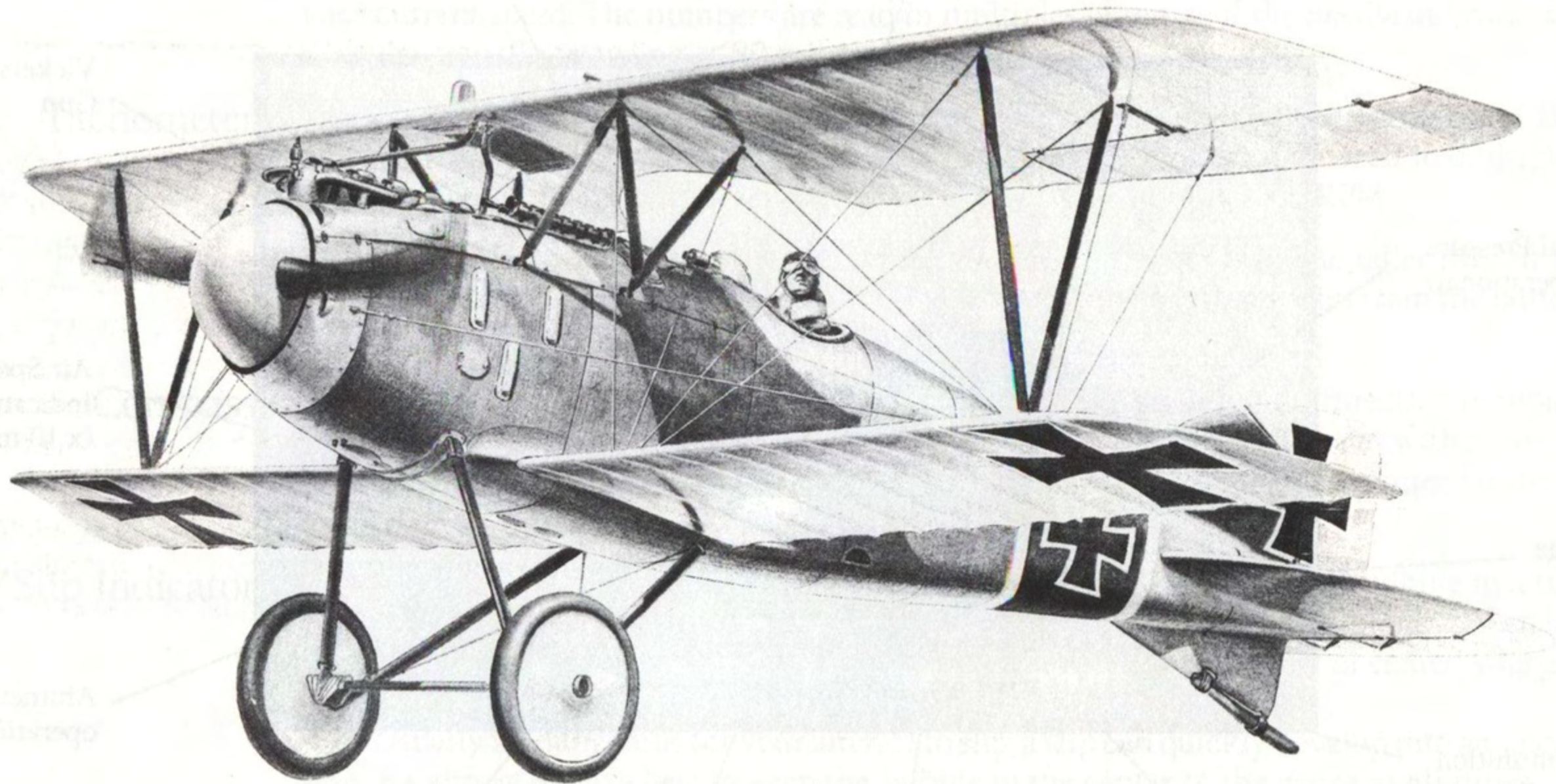

Que se ha hecho

ALBATROS D.III (1917)

3. WORLD WAR I

OVERVIEW OF THE GAME

If you choose World War I from the Main Menu, you've elected to start a career as a pilot during the Great War. You are flying for the Allies against the German Imperial Air Service and your career as a pilot begins in May of 1916. The war has been going on for 21 months and the "Fokker Scourge" is almost over (if you're curious about the Fokker Scourge, see page 64).

Your goal is to survive the remaining 30 months of the war and become the top-scoring pilot (shoot down the most enemy planes and observation balloons) in the war. As the game goes on, time is passing - three to five days between each flight. You must make every flight count if you expect to out-score the other aces that are also active in the game. It may become necessary to hunt down and destroy particular enemy pilots that consistently out-score you.

Most of your flying will be in pursuit of missions that are given to you by a superior officer. But on each and every mission you have the opportunity to destroy enemy aircraft and ground targets. The more of these you destroy, the greater your prestige. With prestige comes medals and promotions. With promotion comes decision-making power.

But more important than anything else is your pursuit of victories over enemy pilots; only by shooting down the enemy can your ace score rise and only through a high score can you become "Ace of Aces."

After each flight you're given information about other events occurring during the war. Some of this information involves enemy aces. You should examine this information carefully for clues about where the top enemy aces are based, where they were last seen, what type and color of planes they're flying, and so on. Based on this information, you'll be able to find and battle these aces and stop them from scoring.

The Flanders Front

The Operational Map

You spend your entire career as a pilot in northwestern France and Belgium – part of which is known as Flanders. You may be based at various aerodromes (airfields) in this area, and from these bases you'll fly sorties against the enemy.

Included with the game is a large paper map of the world over which you fly. One of the main features pictured on the map is “the trenches.” The trenches divide the area into roughly two equal parts; to the east of the trenches is German territory (often referred to as Hunland), and to the west is Allied territory.

At different times during the war the trenches moved in response to ground offensives. During the Spring of 1917, the German ground forces withdrew from a section of their trenches (from Arras southward) to prepared positions known as the “Hindenburg line” (see the map). In the spring of 1918, The Germans advanced almost to Amiens (again, see the map). At other times, the trenches lay roughly between these two extremes. These three trench configurations are pictured on the map and correspond to what you see as you fly over the area in the game.

When the trenches moved, so did the air bases. At any particular time during the war, there are eight Allied aerodromes available to you as bases, and eight German aerodromes available to enemy aces. These 16 aerodromes, called “permanent aerodromes,” are marked on the map and color-coded to show which set of aerodromes goes with which trench configuration. Other aerodromes also appear in the game, but these are never available to you nor the enemy aces as home bases – only as targets for missions and refuelling/rearming.

When you play *Knights of the Sky* keep the Operational Map handy because you'll need it both for navigation and for hunting down enemy aces.

GETTING STARTED

Creating a Pilot

Your Name

Nationality

Difficulty Levels

You must first name your character. When the "Pilot Roster" appears, you can create a new pilot by highlighting one of the names that is already there and tapping the "Escape" key. This erases the highlighted pilot's name and all his statistics. Then, type in the name by which you want your new pilot to be known.

The next decision you must make is whether to fly for the French *Aviation Militaire* (the French air force) or the Royal Flying Corps (RFC, the British air force). Do this by selecting one of the two flags that appear on the screen.

Next, you're given a choice of five levels of difficulty for this pilot. The lower the level of difficulty you choose, the easier the game is to play and win. The following parameters are affected by the level of difficulty you choose.

- Enemy pilot proficiency.
- Your machine gun performances.
- The frequency with which you encounter top enemy Aces.
- At levels 1 and 2 you will not crash if you hit the ground.

Note that within each level of difficulty, a pilot's career becomes more and more challenging as his score of victories increases.

ROSTER SCREEN

Colonel Iris "Icer" Idokogi

Lt. Scott "Slats" Spemburg

Major Chris "Tailsyn" Taormino

2nd Lt. Bill "The Kid" Becker

Major Matt "Skippy" Scibilia

2nd Lt. Jeff "Bul" Briggs

Captain Susan "Leadfoot" Ullrich

2nd Lt. Michael "Hard Case" Haire

Lt. "Jazzy" Jackie Ross

2nd Lt. Al "The Judge" Roireau



Colonel Iris "Icer" Idokogi

Kills: 81

Date: AUG 7, 1918

Missions: 30

Status: DECEASED



CG:15



VC



DSO:12



LH

Choose a pilot then press selector. ESC will erase a pilot.

Choosing an Existing Pilot

If you do not want to start a new career, or if you've created a pilot at some earlier time and simply want to continue his career, select the name of the existing pilot from the Roster. His nationality carries over from the time of his creation, but his difficulty level can be changed.

The Ace Status Screen

After you've chosen your pilot or started a new career, you're shown the "Status Screen." This shows how your pilot ranks among the top enemy and friendly aces that are currently active in that pilot's game. This screen serves as a reminder of how you're doing in your ultimate goal of becoming "Ace of Aces."

For example, if you created a *new* pilot, there will be very few active aces on this screen, because not many flyers have yet attained the title of "Ace." However, if you select an *existing* pilot that has flown a number of missions already, there are likely to be several aces on this screen because more "game-time" has passed and many aces have arrived on the world scene.

The screenshot shows the "ACE STATUS SCREEN" with a list of 10 top aces. The list is titled "Page 1 of 4". Each entry includes a rank number, a nationality flag, the ace's name, and their kill count. At the bottom, there are three buttons: "Previous Page", "Next Page", and "Exit". A legend indicates that a skull icon represents "Deceased" and a plane icon represents "Downed by Bill 'The Kid' Becker".

No.	ace Name	Kills
1.	Charles Nungesser	10
2.	Max Immelman	10
3.	Raymond Collishaw	8
4.	Georges Guynemer	8
5.	Oswald Boelke	7
6.	Albert Ball	7
7.	William Barker	5
8.	Josef Veltjens	5
9.	Joseph Jacobs	5
10.	Rene Dorme	5

☠ - Deceased ✈ - Downed by Bill "The Kid" Becker

Previous Page Next Page Exit

THE HOME MENU

After selecting the pilot you want to use, you're shown the "Home Menu." All currently available options appear on this menu. Certain events may give additional options; other events may remove some.

Standard Options

Fly a Mission

The Standard Options are those that are always available on the Home Menu screen. They include the following:

If you choose this one you're taken to the Briefing Room and assigned a combat mission. This is the option you'll choose most often.

Visit The Hangar

You can visit the "Hangar" at anytime from the home menu. From the Hangar screen, you can choose any plane (that is currently available) to fly in your next mission. You can select any available plane in your Hangar by using the "Next," "Previous," and "Accept Plane" buttons.

Plane Availability: Not all Allied planes are available to you at all times during World War I. The availability of a plane depends upon when the plane was available in the actual war and its appearance in your hangar is affected by your prestige. The best pilots during the war - the famous aces - pretty much got to pick from the best planes available while average flyers had to take what they could get.

View Rankings

This simply allows you to check the Ace Status Screen to see how you're doing.

Look at Portfolio

As part of your quest to become Ace of Aces, you keep a portfolio containing pertinent information about your rival enemy aces. Each page of the portfolio gives the following information:

- the name of the ace
- his current number of victories
- the type of plane he was last known to be flying
- the color of his plane if he has painted it
- the last three places he was seen

From this information, particularly the last three items, you should be able to identify enemy aces when you encounter them. If you're very clever, you'll be able to piece together where some of the enemy aces are based.

Special Options

The following options become available to you only under special circumstances.

Move Your Squadron

Once you've reached the rank of Captain, you're given command of your squadron and have the option to re-base it to any of the eight permanent Allied aerodromes. See "Rebasing Your Squadron," page 39, for an explanation.

Issue a Challenge

Once you reach a high enough score, you have the opportunity to challenge enemy aces to single combat. See page 36 for an explanation.

Accept a Challenge

When your exploits have become well known to your countrymen and to the enemy, your prestige as a pilot soars. You may be challenged by an enemy pilot. See “Accepting a Challenge,” page 37, for details.

Information Bar

At the top of the Home screen, is a horizontal bar that contains summary information about your character in this game of *Knights of the Sky*. This information includes the name of your current home base, your victory score, and the date. You can refer to this for a quick update of your progress in the game.

The Control Panel

Information Summary Menu

If you select the “Control Panel” button, you are shown a menu that allows you to toggle elements of the game on and off. For example, if you don’t want to read every newspaper article, you can toggle Newspapers off; if you don’t want to go to every party, toggle Parties off, and so on.

If you turn these options off, you’ll get an additional menu that allows you to view only the information screens you want to see. Each information screen available after a flight will have an entry on this menu that summarizes its contents. To view the entire screen, select that line from the summary menu.

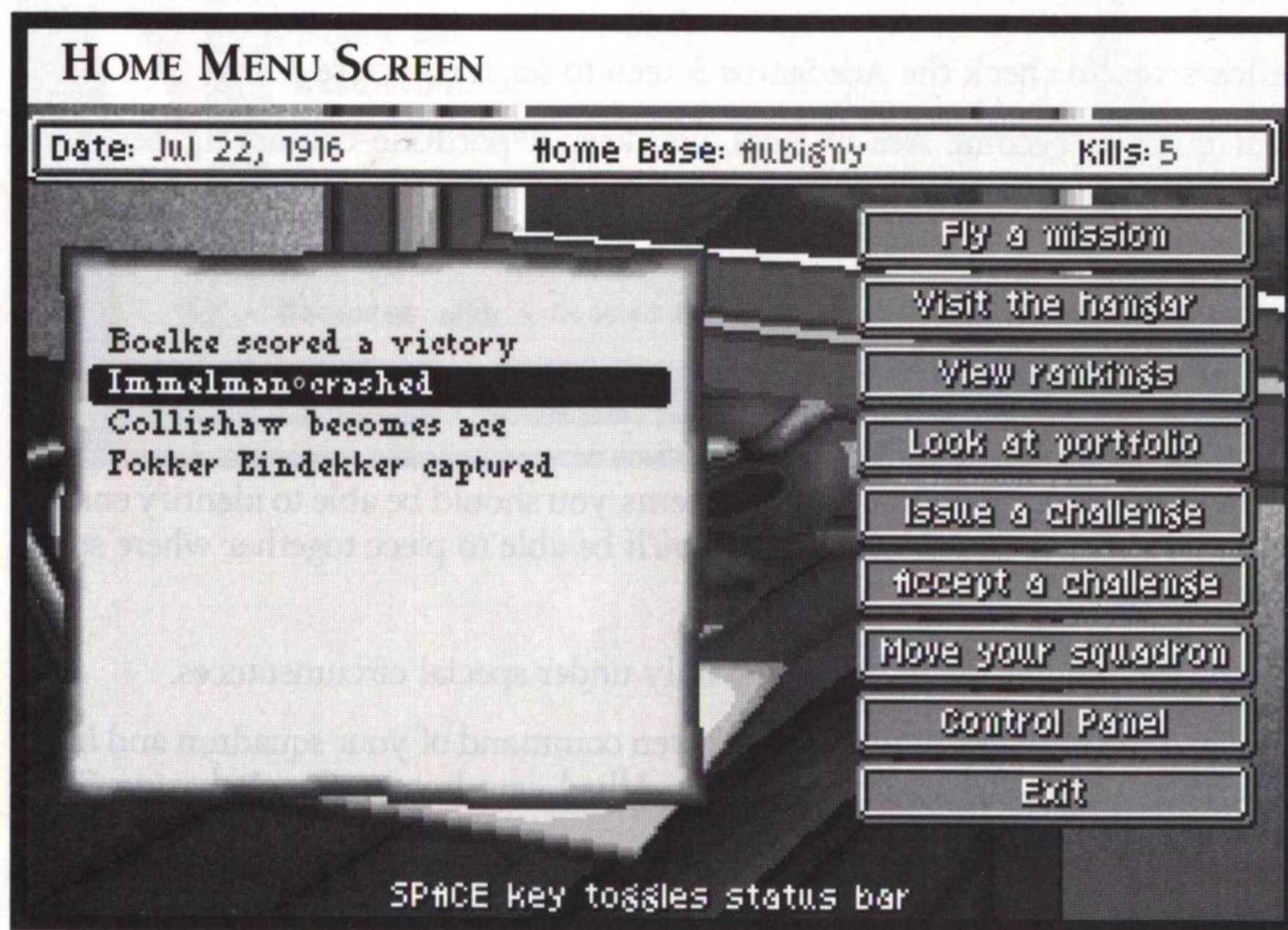

MISSIONS

You spend most of World War I flying combat missions for your country. If you choose “Fly a Mission” from the Home Menu, you’re shown a map of the area in which you’re based and given an assignment.

Each mission assignment outlines the goal of the mission and shows a flight path from your base to the target area. It is always a good idea to follow the given flight path, because intelligence reports say that it’s currently the safest route.

In some missions you’re required to destroy a target on the ground; in others you’re to protect a reconnaissance machine or bomber while it flies its mission; in still others your orders are to destroy an enemy observation balloon.

Briefing

In the briefing, you’re shown a map of the area in which your base lies, given a verbal description of what you must do, and shown a flight path to your destination. You can watch the briefing for a particular mission any number of times by selecting the “Repeat” button.

If you decide to accept the mission current assignment select the “Accept Mission” button. If you do not want to accept the mission, select the “Decline Mission” button and you’ll be returned to the Home Menu. Note that when you decline a mission, game time passes, and the scoring opportunity is missed.

Mission Types

Escort: You are to escort a bomber or recon plane to its target and back. Your sole purpose is to insure the plane’s safe return to your home base. This requires that you follow the other aeroplane.

Patrols: In these missions you are simply to fly along the assigned flight path and destroy any enemy aircraft and/or ground installations you spot.

Ground Strikes: You are to strafe and/or bomb a ground target or targets. In these mission assignments you’re told of a target near a certain town or city. You must follow the given flight path to the town or city, find the target, and destroy it.

BRIEFING SCREEN

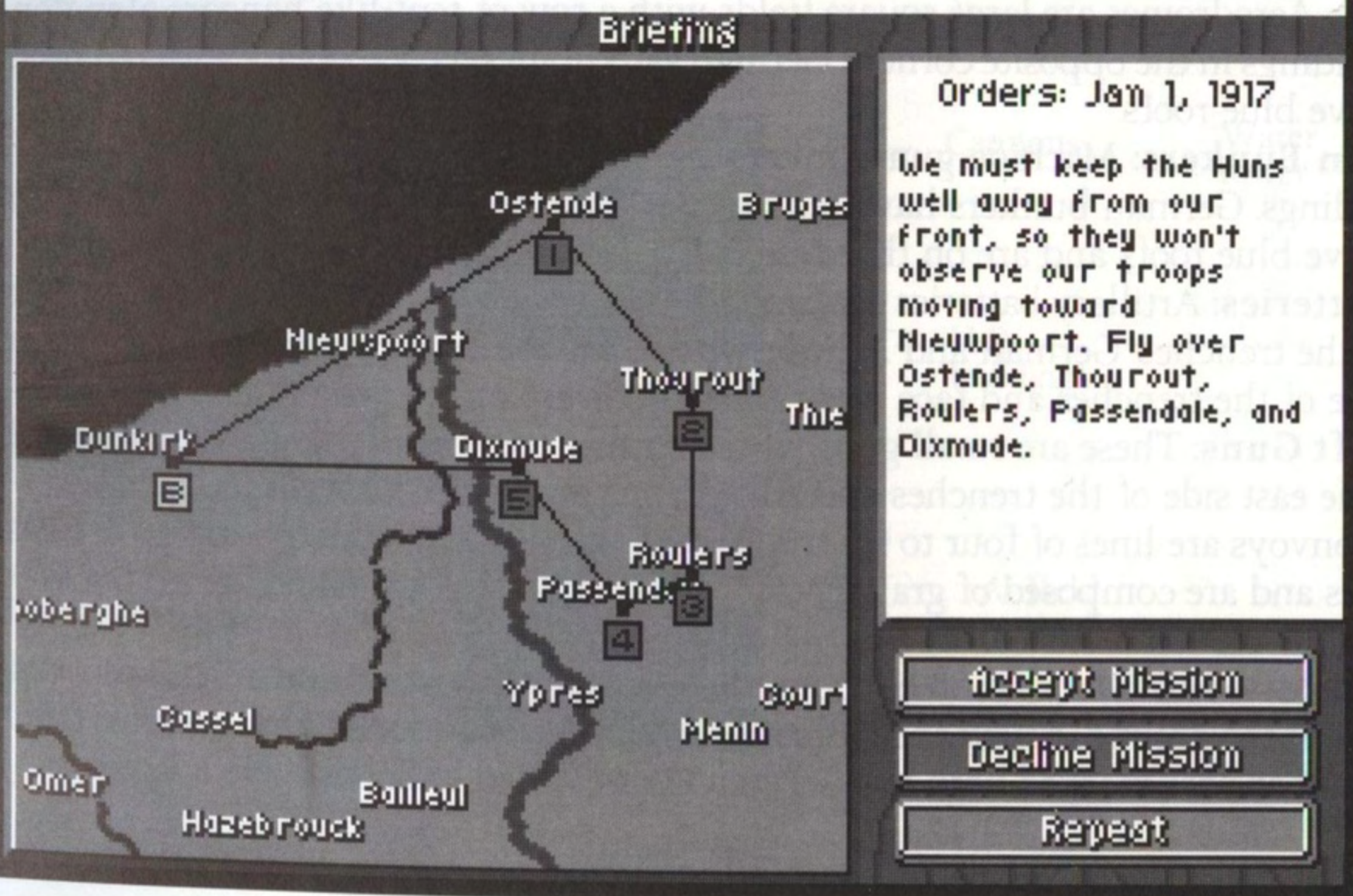

Interceptions: In some cases, the infantry report a flight of enemy planes approaching their sector of the trenches. You must fly to this area and stop the enemy from penetrating Allied territory.

Balloon Busting: Often, headquarters is trying some secret redeployment of troops but an enemy observation balloon has been spying on them. You'll be assigned to destroy this balloon.

Ground Support: When an Allied ground offensive is in progress, you're often called upon to support the attack by bombing and/or strafing an area of the enemy's trench lines. You're to fly to this area and destroy as many enemy ground targets as possible. Of course, as always, enemy aircraft are to be destroyed too, if sighted.

Targets and AA Fire

There are several types of targets on the ground and in the air. There are Allied targets and German targets. You should never destroy Allied targets - that's a bad thing. But you should destroy as many German targets as possible.

Aircraft: All German aircraft are marked by the distinctive "German Cross" that adorns their wings and fuselage; Allied planes are marked with Roundels.

HQs: HQs are large building structures with several vehicles, some artillery and a few smaller associated buildings. German HQs have a large German Cross on top of them; Allied HQs have the appropriate Roundels.

Depots: Depots are large warehouse-like structures with piles of boxes stacked around. Usually a truck or two and some artillery is parked close. German Depots have red roofs; Allied depots have blue roofs.

Aerodromes: Aerodromes are large square fields with a row of tent-like hangars along one side and small buildings in the opposite corners. German aerodromes have hangars with red roofs; Allied hangars have blue roofs.

Machine gun Bunkers: Machine gun bunkers appear only along the trenches. They are squat, square buildings. German bunkers have red roofs and are on the east side of the trenches; Allied bunkers have blue roofs and are on the west side of the trenches.

Artillery Batteries: Artillery batteries are cannons grouped in sets of three guns each. They appear only near the trenches. German and Allied guns look identical except that German guns are on the east side of the trenches and face west; Allied guns are on the west and face east.

Anti-Aircraft Guns: These are small guns whose barrels point nearly straight up. German AA guns are on the east side of the trenches and Allied guns are on the west.

Convoys: Convoys are lines of four to six trucks on roads. German convoys are on the east side of the trenches and are composed of gray trucks; Allied trucks are green and are on the west side of the lines.

Observation Balloons: Observation balloons appear near the trenches and are usually aloft at 4,000' to 7,000'. On the ground, below the balloon, AA guns are positioned along with a truck or two. German balloons are marked with the German Cross; Allied balloons have a Roundel.

AA Fire

Aside from the hazard posed by enemy aircraft (which is significant), the most common threat is AA fire (called "Archie" at the time). This was a new weapon in the first World War, developed specifically to stop aircraft. With an effective ceiling of over 18,000' these guns are one of the biggest threats when you get over the trenches and around balloons. They do not rely so much upon direct hits as shrapnel. The shells explode and release a shower of lead that can damage your machine. Of course there's always the chance of a direct hit, in which case you almost certainly come down.

You see and hear Archie firing when you get near the trenches.

Return to Base or Not?

After you've completed your mission, or if you're low on fuel, or simply want to end your flight, it's best to return to your home base. Your home base is the aerodrome from which you took off, identified by the name of the nearest city. Your home base is always one of the aerodromes marked on the Operational Map. If you are confused about where you are, you can always tap the map key (space bar) to see what area you are in. Then, by examining the Operational Map and observing the road network in the game and on the map, you can find your way back.

You may land anywhere in the world you want, but if you return to your home base, you're rewarded. Landing at another Allied aerodrome is safe, but it takes valuable time to get back to your squadron. If you land at an enemy base, you may be captured - or even killed. If you land in enemy territory, but not at a base, you'll probably survive but, again, you lose valuable time. The long and short of it is that you should make every attempt to return to your home base after each mission.

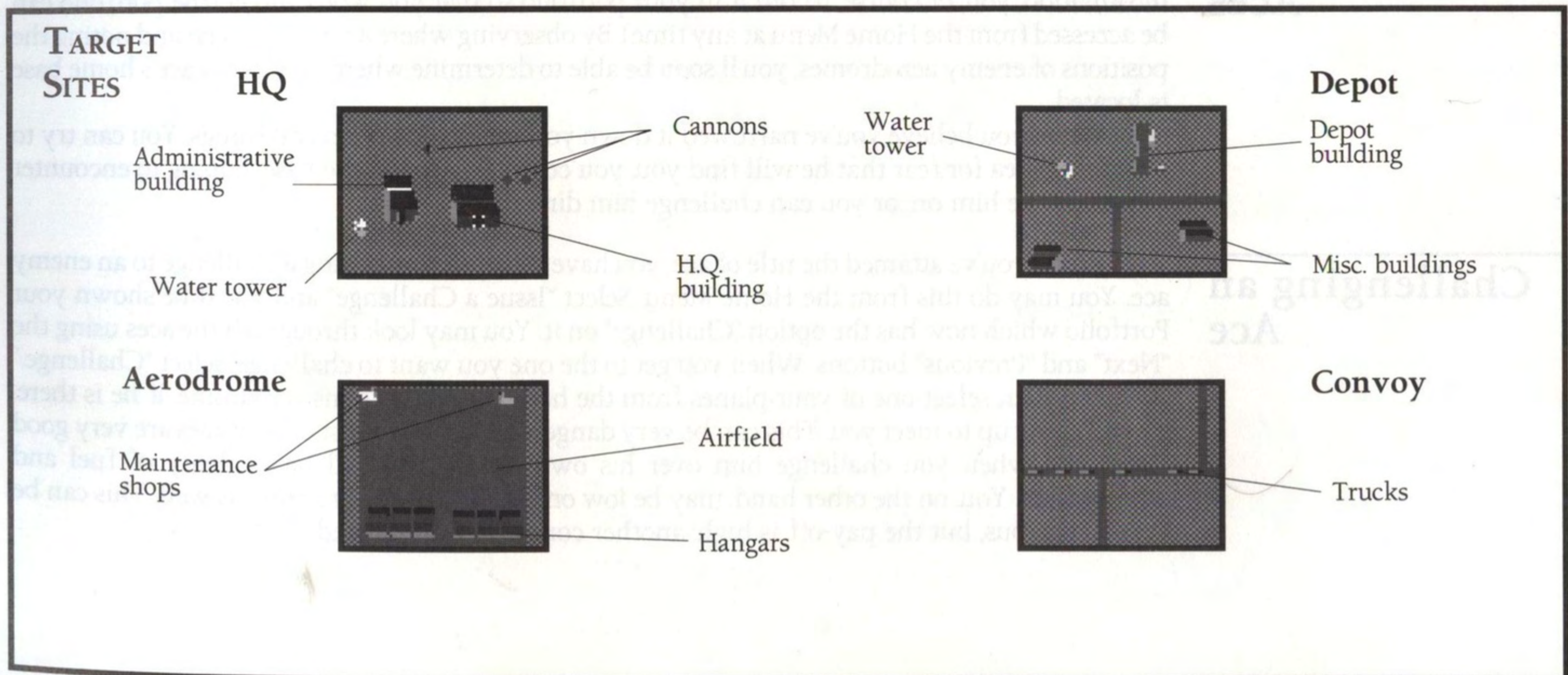

BECOMING “ACE OF ACES”

When you’ve shot down your fifth enemy plane or balloon, you’ll be known as an ace. This is good, but there are other aces in the war who continue to rack up high ace scores. To be truly great, you must out-score them all – become the Ace of Aces. As your ace score rises so does theirs, and you’ll soon realize that they must be stopped. You could sit back and wait for some other Allied pilot to take them out (and get the glory), or you can take the bull by the horns and do it yourself.

There are 16 Allied aces and 16 German aces. The Allied aces are not competing with you directly, they will score but there’s nothing you can do about that. You can, however, do something about the scoring of the German Aces; *shoot them down!*

Information Screens

After each flight, you get information about events taking place in the war on the Flanders Front and on the Western Front in general. The information comes from various sources: you read the newspaper, talk to other pilots in the local pub, hear rumors at high society parties, or compare notes with your mechanic.

All the information you get may be useful in the pursuit of your goals, so pay careful attention to what you hear.

Finding Enemy Aces

Some of the information screens will tell you about the exploits of enemy aces – where they were last seen, what plane they were flying, what color it was, and so on. When you hear this information, you, of course, record it in your portfolio so that you won’t forget (the portfolio can be accessed from the Home Menu at any time). By observing where an ace was seen and noting the positions of enemy aerodromes, you’ll soon be able to determine where the enemy ace’s home base is located.

When you believe you’ve narrowed it down you can do one of several things. You can try to avoid that area for fear that he will find you; you could fly around the base, hoping to encounter him and take him on; or you can challenge him directly.

Challenging an Ace

When you’ve attained the title of ace, you have the option of issuing a challenge to an enemy ace. You may do this from the Home Menu. Select “Issue a Challenge” and you’ll be shown your Portfolio which now has the option “Challenge” on it. You may look through all the aces using the “Next” and “Previous” buttons. When you get to the one you want to challenge, select “Challenge.”

You then select one of your planes from the hangar and fly to his aerodrome. If he is there, he will come up to meet you. This can be very dangerous, because most enemy aces are very good flyers and when you challenge him over his own airfield, he will have plenty of fuel and ammunition. You, on the other hand, may be low on fuel and possibly ammo as well. This can be very dangerous, but the pay-off is high: another competitor eliminated.

Accepting a Challenge

Your enemy competitors probably keep their own portfolios. Once you've become an ace and your reputation spreads, some jealous enemy ace may read of your skill in the newspapers, decide it is time to end your career once and for all, and challenge you to a duel in the air.

If this occurs, a new option "Accept a Challenge" appears on your Home Menu. If you accept the challenge, you must fly to the place stipulated and meet your rival... good luck!

MEDALS

SCORING

There are two types of scores in *Knights of the Sky*: your career score and your ace score. Each time you destroy a target, your career score is affected. Your ace score is affected only by destroying enemy aircraft and observation balloons. Your overall performance – your career score and your ace score taken together – determines your prestige among other pilots, enemy and friendly, in the war.

Your career score is never shown to you, but is reflected by the medals and promotions you receive for accomplishments (see Medals and Promotions, below). You receive medals for individual missions that were extremely successful; you get promoted for consistently good performance over several missions.

If you destroy an Allied target, your score is adversely affected; if you destroy a German target, your score is positively affected. There are other structures and objects on the ground aside from military targets, such as buildings in towns and cities, trees, churches, and so on. If you destroy any of these, your career score is reduced. Remember, it's good to destroy as many enemy targets as possible; civilian and friendly targets are off limits.

Your career score is positively affected when you return to your home base after completing your mission. It is adversely affected if you do not. Obviously it's always better to return to a friendly base than to an enemy base, and in general it's always better to return to a base rather than a field somewhere.

Targets

Returning to Base

PROMOTIONS

You start your career as a lowly corporal. Promotions are based upon your prestige and consistency. If you continually complete missions successfully you'll be promoted quickly; if you screw up and do poorly in a mission, you may need extra, high-scoring missions to qualify for promotion. Available ranks include: Corporal, 2nd Lieutenant, 1st Lieutenant, Captain, Major, Lt. Colonel, and Colonel.

Rebasing Your Squadron

Once you've reached the rank of Captain, you're given command of your squadron and have the option to re-base it to any of the eight permanent Allied aerodromes (see The Operational Map, page 28).

If you choose this option, a map of the Flanders Front appears, showing the available permanent aerodromes. By using the "Next Base" and "Previous Base" buttons you can highlight any one of the available bases, then select it by using the "New Base" button.

Rebasing your squadron can be useful for several reasons: First, if there's a major ground battle taking place (which you'll learn about from various sources), you may want your squadron based closer to it. This way, you get more opportunities for dogfighting important enemy aces and for assignment to potentially high-scoring missions.

Second, if you think important enemy aces are based in a particular area, you may want to move your squadron closer to this area so you have a better chance of encountering them - remember, to become ace of aces, you must stop those other guys from scoring.

Third, when you think you know for sure where an important ace is based, you might want to challenge him to single combat. It's best to be as close as possible to his aerodrome before you issue a challenge, because you'll need as much fuel as possible when he comes up to meet you.

Fourth, you may want to move away from any of these situations if you think you're not yet ready to face them. Sometimes caution is the better part of valor.

MEDALS

If you do extremely well on a single mission, the high command may recommend you for a decoration. The receipt of a medal from your country, or from an Allied country increases your prestige tremendously.

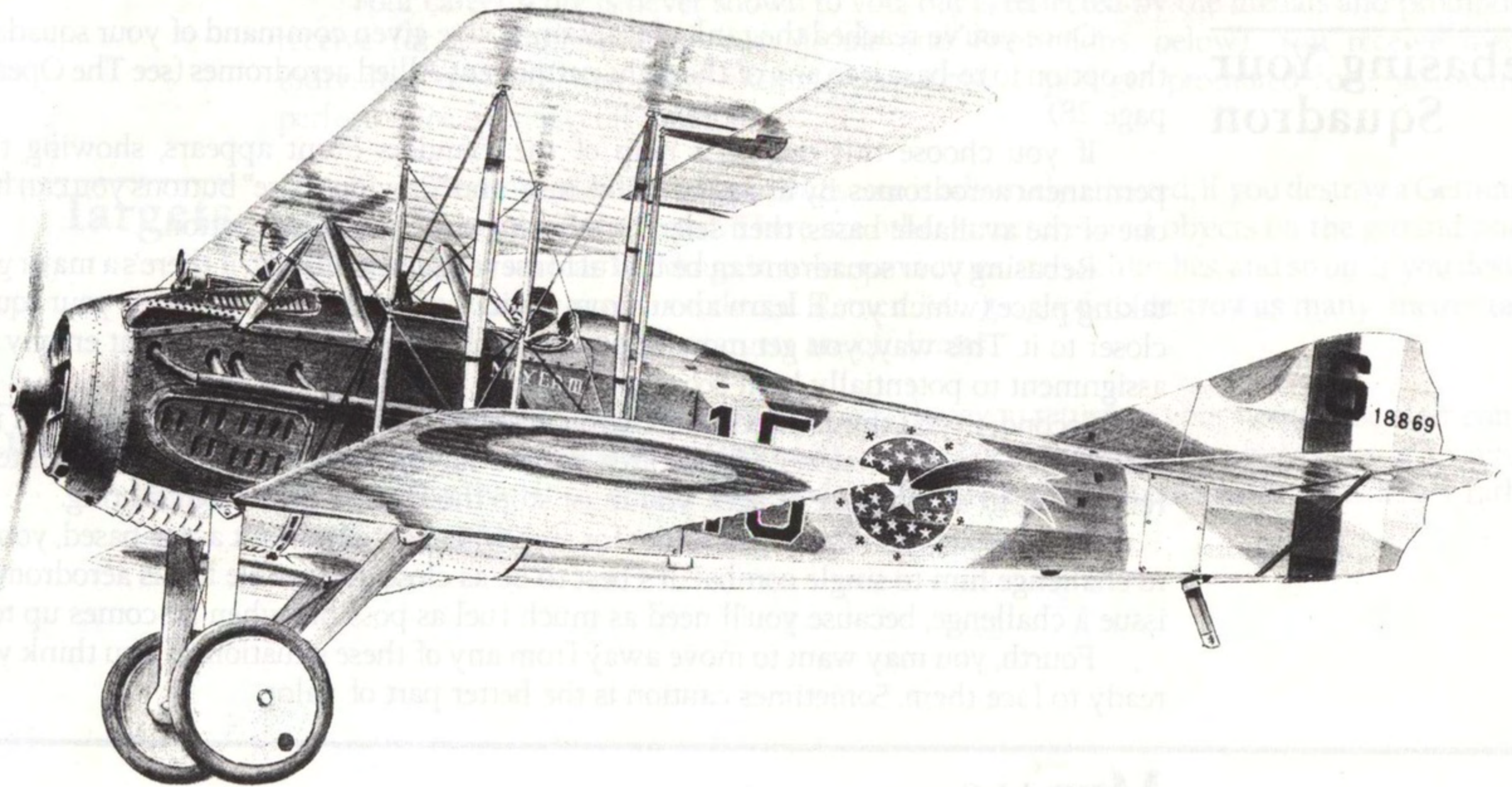

Joe All Hands

SPAD XIII (1917)

4. PRACTICE GAMES

“Flight Training” and “Dogfight Encounters” are referred to here as practice games because, while they are fun and exciting in and of themselves, they’re also very effective preparation for the World War I game. Using these two modes, you can practice for all the flight challenges you’ll face when you begin World War I.

FLIGHT TRAINING

If you choose “Flight Training” from the Main Menu you are given several options that control the training environment.

You are first offered the opportunity to choose the type of opposition that you will encounter during the training mission.

In this mode you have the entire sky to yourself to practice aerial manoeuvres or simply do some sight-seeing.

If you choose unarmed enemies you’ll see enemy fighters, but they won’t attempt to shoot you down. They will engage you in mock dogfights and you can shoot at them, but they are there for target practice only.

If you choose Armed Enemies then you’ll encounter enemy pilots who try to shoot you out of the sky.

Next you are asked to choose how difficult you want the training to be. Level 1 is the easiest mode and level 5 is the most difficult. In levels 1 and 2 you can’t crash your plane; it simply bounces if you get too close to the ground.

Choose The Opposition

No Enemies

Unarmed Enemies

Armed Enemies

Choose The Difficulty Level

Choose Your Plane

Next you are taken into a hangar and shown all the aircraft available for you to fly. If you find one of them more difficult to handle than another, choose it and get some practice. You can look through all the planes by using the "Next" and "Previous" buttons, then select the one you want by using the "Accept Plane" button.

Choose Your Base

Next you are shown a map of the Flanders area of the Western Front. On this screen, you can choose the aerodrome from which you wish to take off.

On the right is a view of the entire map, picturing the trenchline (running north to south through the middle), the main rivers, and the sixteen permanent aerodromes. (This map corresponds to the Operational Map of the Flanders Front also included in this game.) A section of the map is boxed, and one of the aerodromes inside the box flashes indicating the currently-selected aerodrome. Above this map is the name of the flashing aerodrome.

The large map on the left is a zoomed-in view, of the boxed area on the right-side map. This one shows town-names, roads, rivers, and the trenches. The currently selected base is marked and is near the town named above the small map.

Regardless of the nationality of the plane you choose, you will take-off from an Allied aerodrome. If you chose a German aeroplane from the Hangar, you'll fly a captured one from one of your bases on the allied side of the trenches. Use the "Next Base" and "Previous Base" buttons to move from one base to another, and the "Accept Base" button to select the base you want to accept.

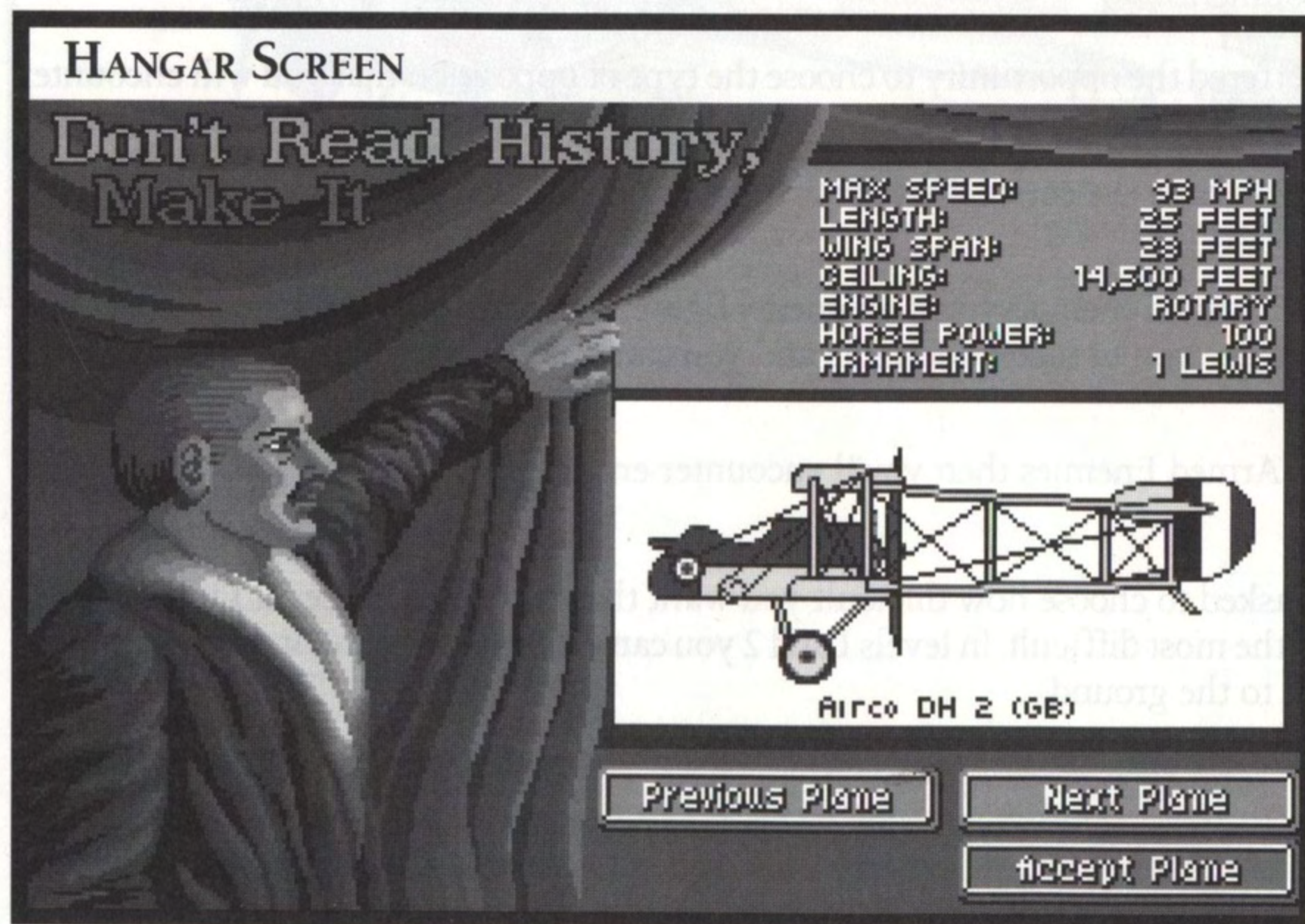

Flying In Training

Sight-Seeing

Choosing "No Enemies" gives you a chance to fly around and look at the sights. You can practice navigating by examining your map (space bar) and move quickly from one area of the map to another by using the *direction keys*, N, S, E and W. While on the map screen, tapping the "N" key moves your plane 4 miles North, the "S" key moves you south, the "E" key east, and the "W" key moves you west. These keys are active only in Flight Training.

Trying Manoeuvres

Flight training with or without active enemies gives you a good opportunity to try some aerial manoeuvres. You may want to practice with the "Remote Control" (F1) or "Slot Front" (F5) views, because in these modes you can clearly see how your aeroplane responds to control changes.

Landing Practice

Flight Training is the perfect environment in which to practice takeoffs and landings. As long as you never crash or switch your engine off you can take off and land as many times as you wish, without the threat of enemy attacks.

DOGFIGHT ENCOUNTERS

When playing the World War I game, you eventually encounter the great German aces of history. In fact, in order to "win" that game - to become ace of aces - you have to destroy these guys. To give you an idea of what to expect from them when you meet them in that game, we offer you the opportunity to challenge them outside that game.

In "Dogfight Encounters" you can choose the particular ace you want to deal with or you can choose to fly against another, less experienced and skilled pilot.

After choosing "Dogfight Encounter" from the Main Menu, you are taken to the hangar to choose your plane. You can look through all the planes by using the "Next" and "Previous" buttons, then select the one you want by using the "Accept Plane" button. Look carefully at the plane the ace is flying and choose yours accordingly.

Next, you are shown a portfolio that contains the names and other information about 16 German aces. Using the "Next" and "Previous" buttons, look through all of them and decide which one you want to meet. Then use the "Accept Ace" button to start the game.

The portfolio gives certain information about each ace.

Name: The ace's name.

Historical Score: The number of confirmed victories he scored during the war.

Plane: The type of plane he flies in this encounter.

Plane Color: The color of his plane.

Choose a Plane

Choose an Opponent

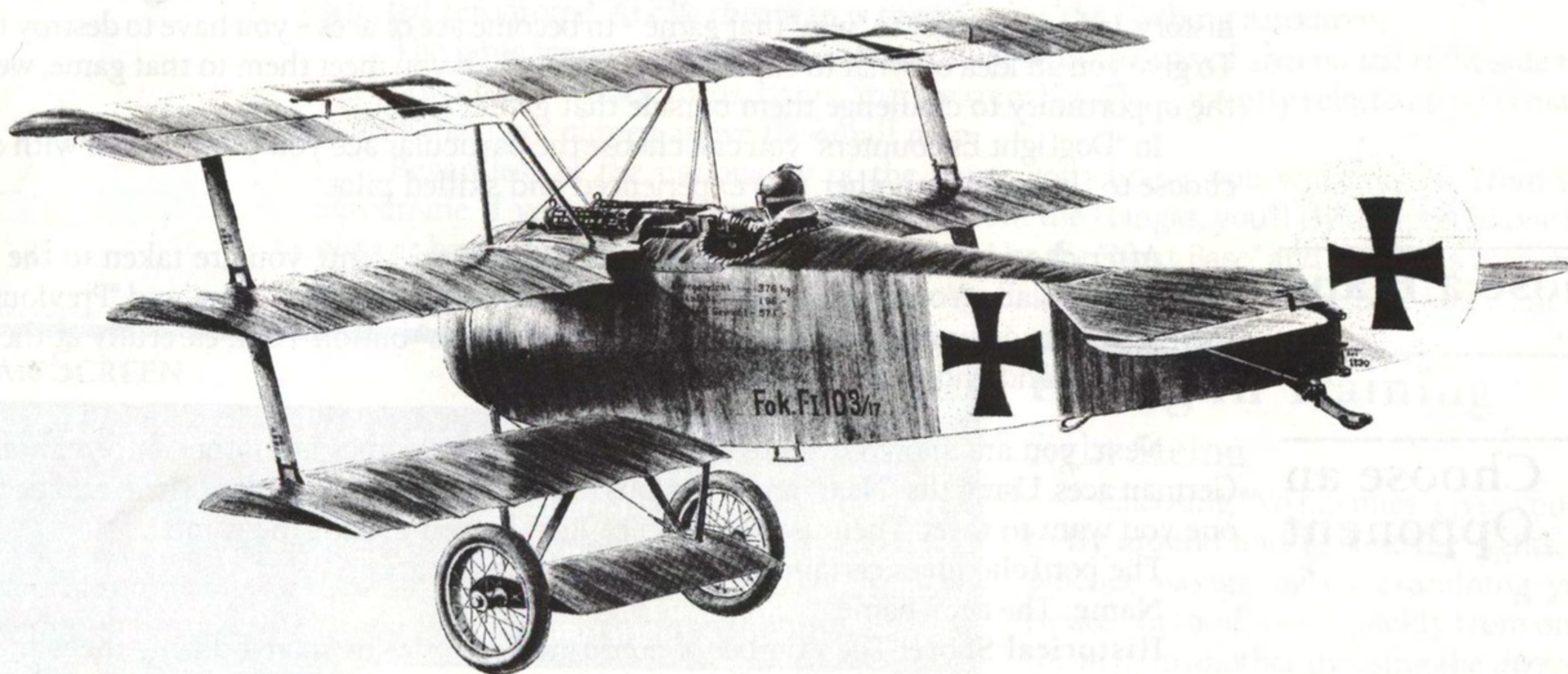

Jacques M. H. H. H.

FOKKER Dr.I (1917)

5. HEAD TO HEAD PLAY

If you select "Head to Head" from the Main Menu, you can play *Knights of the Sky* with another person.

If you and the other person have Hayes-compatible modems and both of you own *Knights of the Sky*, you can play the game against each other over the phone lines. Refer to your modem instructions for how to set up and use your modem.

If the other person and his computer are close enough and you have a null modem cable and communications ports, you can link the computers directly via the cable. Simply connect the cable from the serial port of one of the computers to the serial port of the other.

STARTING THE GAME

Name

When asked to enter your name, simply type the name by which you will be known for these dogfight encounters.

Com Port

If you have only one communications port (serial port) the program assumes you are using it and skips this menu. If your computer is equipped with more than one communications port you will be asked which communications port you are using. If you do not have a communications port you get the message "No Communications Port" and you are returned to the Main menu.

Baud Rate

Next you are asked at what baud rate you will be passing information. If you are communicating via a direct cable, we suggest you use 9600. If you are communicating via a modem, check your owner's manual to determine which choice you should make.

In general, the higher the baud rate you select for the game, the faster and more realistically the game will play.

Call or Wait

You are now asked if you will initiate or wait for a call, answer immediately, or connect directly. The correct response depends upon what form of connection you are using: modem or direct connect.

If there are problems in making the connection, you are prompted and informed of the problem; otherwise you are moved immediately to the Hangar screen.

Modem

If you are playing with a modem it is a good idea to contact the person you will be competing with to decide who will "initiate" and who will "wait for" the call. For the two machines to achieve smooth communication, one computer (the initiator) sends a "hello" message while the other (the waiter) waits to receive the "hello."

Initiate/Wait for a Call: After deciding who will call and who will wait, you can both hang up your phones. The "caller" should start the start-up sequence and select "Initiate Call" from the "What will you do..." screen. "The waiter" should select "Wait for a Call."

Answer Immediately: Alternatively, and perhaps more sensibly, the players can stay on the phone lines after deciding who will call. The phone connection is already made, so all that is necessary is for the Modems to begin talking.

For this circumstance, the "caller" should select "Initiate a Call" and the "waiter" should select "Answer Immediately" from the menu.

Direct Connect

If you are playing with a direct connection, both players should select the "Connect Directly" option from the menu.

Choose a Plane

On the Hangar screen, you are given the choice of which of the 20 fighters in the game you wish to fly. Look through the available planes by using the "Next" and "Previous" buttons, then use the "Accept Plane" button to select the one you want. Note that for each plane, technical information describing the plane's top speed, its armament, its engine, and so on appears in the upper right hand corner of the screen.

Handicapping

If you want to balance a game between two players of disparate abilities or between a novice player and an expert, give the more experienced player a plane from early in the war and the less experienced player a later one (see the "Fighter Appearance Chart," on page 94).

Chat Mode

At anytime after the connection is made between your computers, you can type messages to the other machine using Chat Mode. To enter Chat Mode, tap the "Tab" key. You can then type a message to your opponent. When you strike the "Enter" key, the message is sent and you exit Chat mode. Note that while in Chat mode (after tapping the "Tab" key, but before striking "Enter") any keys you hit are interpreted as part of the message, not as aircraft control keys.

RULES OF THE GAME

When the game begins, you find yourself in the cockpit of your chosen plane, already airborne. You may or may not see your opponent's aircraft at first. Use the Tactical View (F2) to find your opponent; then it's up to you.

The object of the game is very simple: You must shoot your opponent out of the sky, or force him to crash before he does the same to you.

THE SCORE SCREEN

You may fly any number of times against your opponent. After each flight, you'll see the Score Screen that reports what happened and updates the score.

- You lose 1 point if you crash.
- You gain 1 point if your opponent crashes.
- You gain 2 points if you shoot your opponent down.

While on the score screen you may select either "Fly Again" or "Exit."

Fly Again or Exit

If you select "Fly Again" from the Score Screen, you immediately go back to the hangar to choose another plane.

If you select "Exit" from the Score Screen, you are returned to the Main Menu.

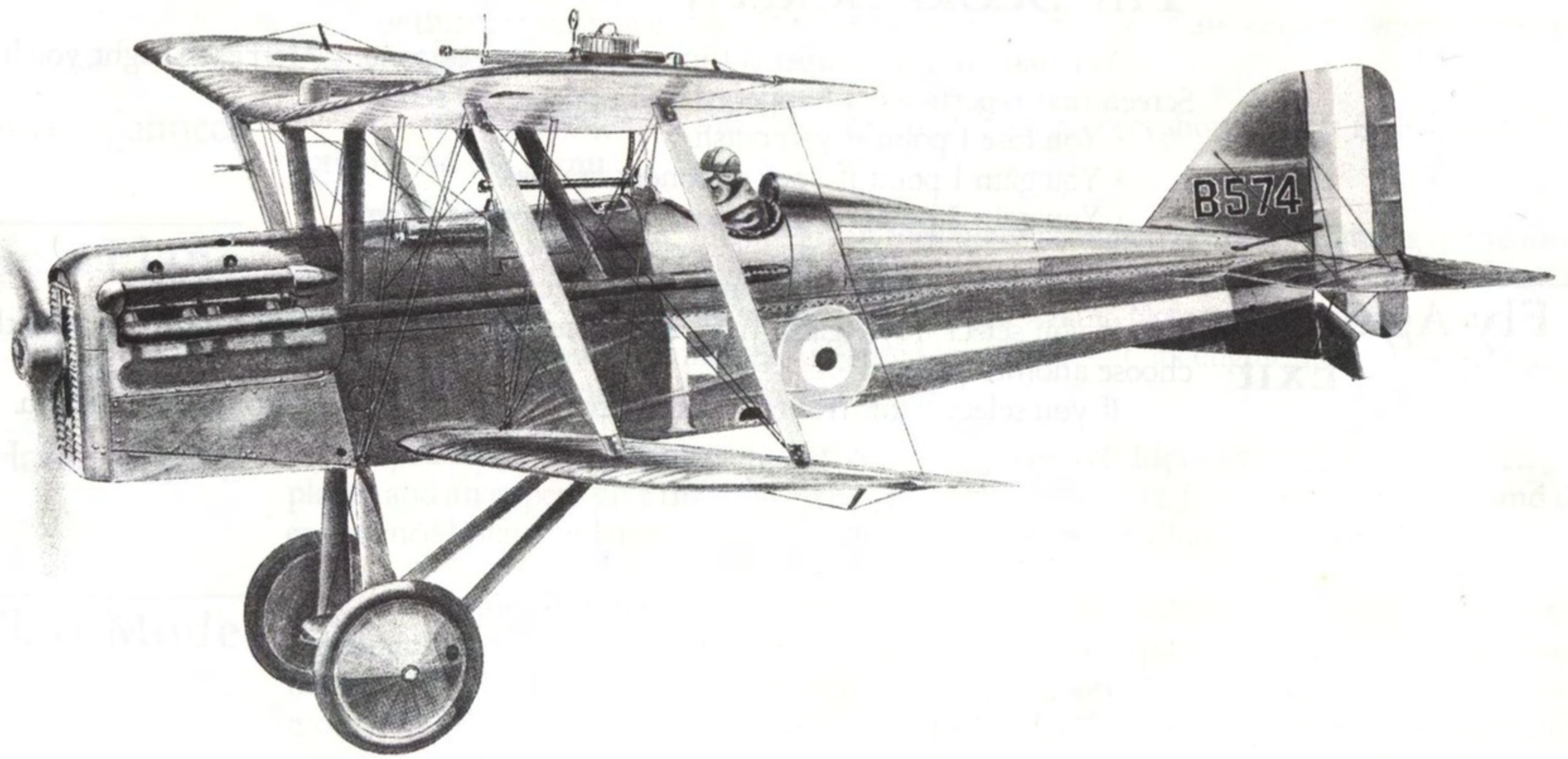

Joe McKean

S.E.5 (1917)

6. USING YOUR AEROPLANE

HOW TO FLY

The simplicity of the aeroplanes of 1916-1918 makes it quite easy to understand the rudiments of flying, because there aren't many controls that must be mastered. The challenge is mastery of *techniques*, and learning to use those techniques to best advantage.

To start the engine, tap the "O" key. You'll observe your tachometer spring to life. Increase your RPMs by tapping the *throttle up* key (+) a few more times, and you'll notice that the plane begins to move slowly along the airfield.

After the plane begins to move, tap the *throttle up* key (+) a few more times or press the *max throttle* key (Shift/+). You now begin to gain speed.

As you move along the field, begin pulling back on the stick. When the plane gains enough speed (30-40 MPH) you'll begin rising from the field.

It is important not to try to climb too fast. Your plane stalls very easily (see "Stalls" below) so it's a good idea to climb very gently until you reach an altitude of 600-700'. While climbing, keep your wings level with the ground and the nose of the plane pitched slightly up. If your airspeed starts dropping, you may have the nose pitched up too steeply, so pitch down a little. Your biggest concern right now is to avoid stalling; a stall at such low altitude could be very bad.

When you've reached 800' you may want to try a turn or two, but not too steeply. Wait until you're at 1000' at least before you try any fancy moves.

One of the hazards that you have to learn to deal with when flying old aircraft is stalling. A stall occurs when your airspeed drops to a point at which insufficient lift is being produced beneath the wings. Additionally, even at high speeds, if your pitch is too steep, a stall occurs because of insufficient lift.

Stalls most commonly occur when you're climbing too steeply. Gravity slows the plane to a point where the propeller can no longer pull the aircraft through the air. The nose drops and you go into a steep dive. Of course, as soon as you begin diving the plane picks up speed fast, and the

Takeoff

Starting the Engine

Taxiing

Climbing

Flying Techniques

Stalls

stall is cancelled. The danger is in stalling too close the ground – instead of recovering from the stall during the dive, you crash!

You may find that when you first try to loop, you stall at the top of the climb. It is usually best to start the loop manoeuvre with a dive, so you gain additional speed; the momentum will then carry your aeroplane over the top.

A Light Touch on the Stick

The most important thing to remember is to have a light touch on the stick. It is easy to go careening back and forth across the sky like a madman. Make smooth, gentle control changes. Aeroplanes of this era were extremely manoeuvrable. They could almost literally turn on a dime when flown by a man who knew his business.

The response to the control stick is very quick when starting from a stable position. For example, when you're flying with wings level, and you pull the stick to the right, the plane responds almost immediately. But when you're in the midst of a turn and you want to go the other way, the plane responds much more slowly.

Likewise when you try to level the wings from a banking turn, you have to do it gently because your aeroplane will continue to slip a little. It is best to anticipate when you want the plane to be level and make the control change just ahead of when you think you should.

Remember, at first the aeroplane will seem quite difficult to control, but don't be frustrated. After a little practice with each plane, you'll get the hang of it.

Level Flight

True level flight is difficult to achieve in any of your fighters. Your plane has a tendency to climb or dive at all times so you'll find yourself constantly adjusting your altitude by pitching up or down a little. These constant adjustments take very little pitch change, so don't go overboard in trying to attain a smooth, level flight.

After some experience, however, you'll see that continual climbing is not such a bad idea anyway, because altitude in dogfighting is very good. He who is higher has more potential speed, and speed in a dogfight is almost always good.

Navigation

Your plane contains only one navigational aid: your dashboard compass. You can tell at a glance in which direction you're currently heading, but there are no navigational beacons nor radar to guide you through your flight.

However, you carry with you at all times a map of the area over which you're flying. This can be accessed by tapping the "Space Bar." The map displays a section of the Western Front, with your current position in the center of the screen. By comparing the roads and rivers you see outside your plane with those on the map, you'll be able to determine where in the world you are. Want to go to Amiens? Follow the roads and rivers to Amiens.

Of course the game also provides a big, beautiful paper map of your sector of the Western Front, which you can also use. Note that there are 16 aerodromes pictured on the map, 8 Allied and 8 German. You're always based at one of the Allied aerodromes. Each aerodrome is near a town or city, and is identified by the name of the town or city it is near.

Landing

One of the more difficult and dangerous manoeuvres in flying is getting back on the ground safely. This was especially true during 1916-18. There were no flight manuals to help pilots learn to land, and there were no feedback devices (except maybe an instructor) in the cockpit to tell him how he was doing. Pilots learned by trial and error - hopefully more trial than error. Luckily, a pilot attempting to land usually didn't have far to fall and was going as slow as he possibly could.

We strongly suggest using Flight Training as a means for learning to land before seriously attempting the World War I game. But for those who don't want to learn, we have provided the Auto-Land feature.

Aerodromes

Aerodromes are large, dark, square areas with a row of hangars along one side and two small buildings in the corners opposite the hangars. They are visible from very long distances. In the game, the Allied aerodromes have hangars with blue tops and German aerodromes have hangars with red tops. They're roughly twice the size of real aerodromes, so you should have a large safety margin.

Approaching the Field

You don't have to approach the field from any specific direction to land safely; the field is square and there's no "runway." Simply point your plane toward the field when you're very far away and close the throttle gradually as you approach. Watch your altimeter to make sure you're not losing altitude too fast. It is important to keep the nose of the aeroplane pitched slightly up during your approach and to balance your throttle with the amount of pitch - stalling during your approach can result in a crash.

FOKKER BOUNCE

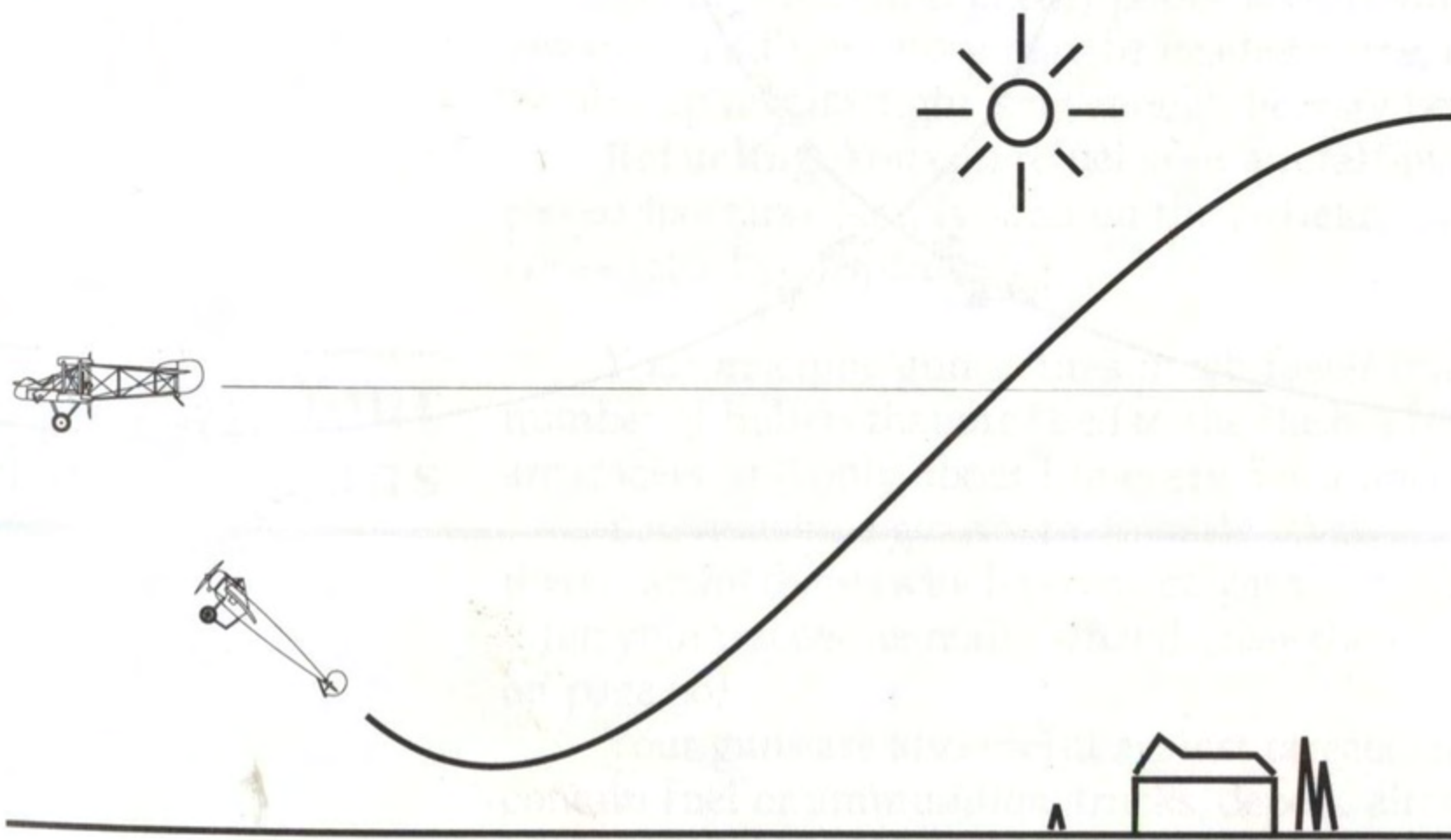

This is a common manoeuvre used by the early Fokker pilots, Immelman and Boelcke. Diving out of the sun on the rear of the victim, the Fokker would make an attack on the diving pass, then, using the speed gained from the dive, attack again from beneath the prey. To avoid this, don't let them get behind you! Failing that, turn to face them as soon as possible, or turn away sharply after the initial attack dive.

Touching down

To touch down safely, your angle of approach must not be too steep and your speed must not be too great. You can achieve this by pitching up slightly right before touchdown. Once you're on the ground, your plane stops rolling. If you're ready to end this flight, cut the engine by tapping *engine switch key* (O). The game now assumes you've finished the flight.

Auto Landing

Because landing can be difficult and this is a game about aerial combat and not about landing, lower difficulty levels (1-3) of *Knights of the Sky* give you the option of landing automatically.

Simply fly over the aerodrome at which you want to land and tap the *Auto-Land Key* (L) while you're over it. A message appears saying "Auto Land." The computer takes control of your aircraft and brings you in for a smooth landing.

If you decide that you don't want to land at this particular aerodrome, simply tap the "L" key again to toggle the auto-land off.

FULL LOOP

This manoeuvre may be used on unsuspecting and/or inexperienced pilots as a means of getting them off your tail and you on theirs. Gain considerable speed from a dive, pull back on the stick and keep it there. You'll go into a steep climb that'll take you over the top. Chances are, your victim will not react quickly enough to prevent you coming down on his tail.

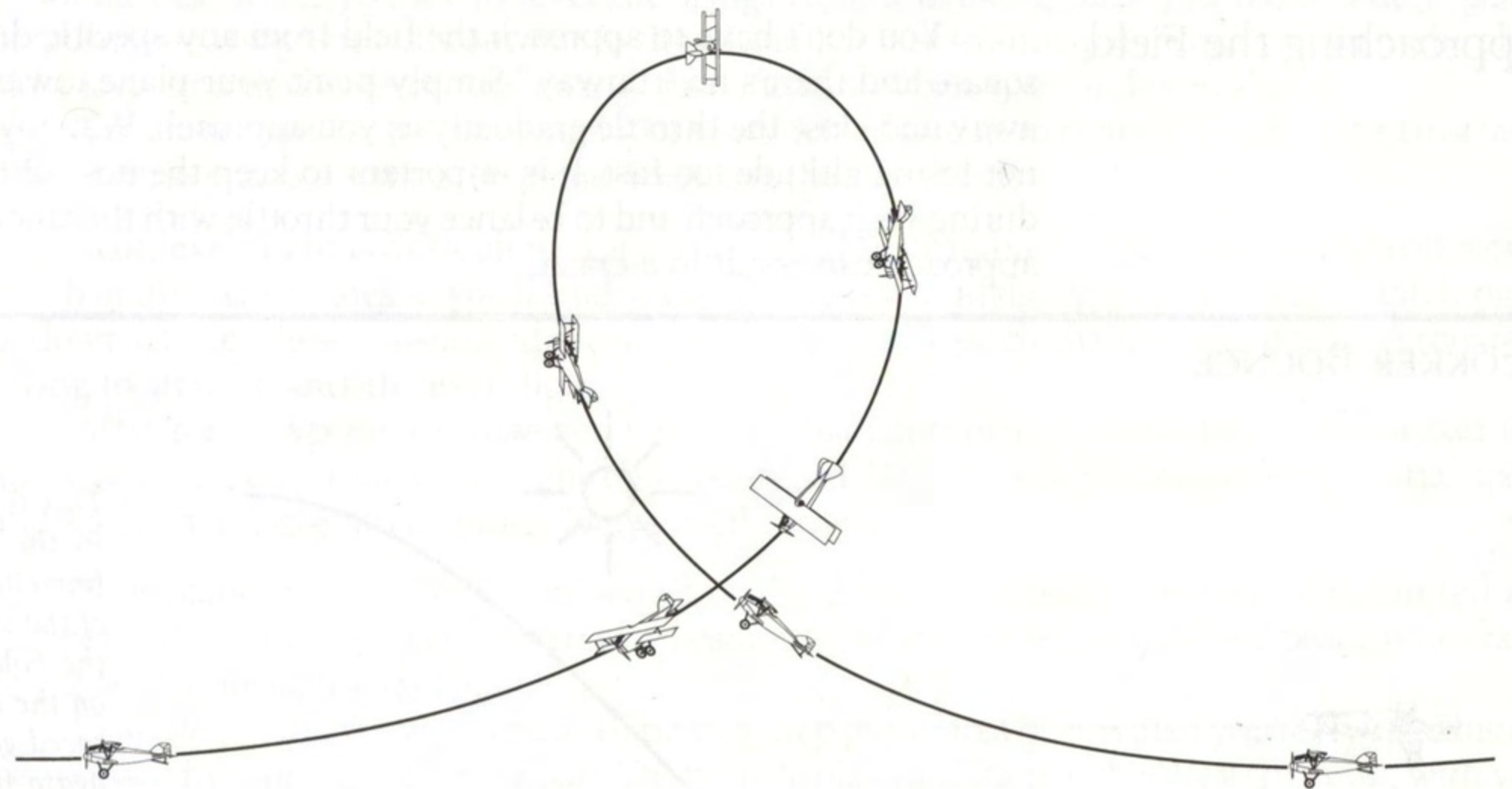

HOW TO FIGHT

In *Knights of the Sky*, you're a fighter pilot in World War I. As such, your job, simply, is fighting. The skies are full of enemy pilots who would like to see your plane *burn*. While the air war of 1914-18 is noted for its "chivalry," the bottom line is that pilots got killed, and the pilot who knew how to kill his opponent survived - if not throughout the war, at least longer than the ones who didn't.

A Watchful Eye

The first thing to remember is to look! You must look at all times in all directions. You do not have sophisticated radar equipment to warn of an enemy's approach. You don't have missiles that can knock an enemy out of the sky from a range of many miles. No, you have a little plane made of wood and canvas equipped with a machine gun that is accurate only at up to 100 yards. It is good that your opponents have no more than you do. But they will try anything to catch you off guard.

To avoid being caught napping, you must constantly be on the lookout for enemy aircraft. Use all your views, especially the Tactical View ("F2"), to search 360° of the sky. And don't forget to look up and down; it's possible for an enemy to fly well above or below you to avoid detection.

The Fuel Factor

You have a fuel gauge on the left side of your cockpit. If you run out of fuel during flight, your engine will shut down and you'll fall. It's possible to make a safe landing under these conditions, but impossible to manoeuvre. If you're low on fuel and an enemy shows up, it may be better to avoid fighting. The enemy would enjoy nothing more than scoring an easy victory against a falling plane.

On the other hand, enemy pilots have to watch their fuel too. A German aeroplane flying east toward friendly territory may be headed home, in which case he may be low on fuel. If you can tie him up in a dogfight long enough he may become an easy victory for you.

Refueling: You can refuel your aircraft by landing at any Allied Base (those with the blue roofed hangars). Simply land on the airfield - without turning the the engine off - and ground crews refuel your plane.

Using Your Machine guns

Your machine gun(s) fires much faster than it appears, as you'll notice by comparing the number of bullets that are fired to the flashes from the barrels. Also, the bullets you actually see are tracers, and only about 1 in every 5 is a tracer.

Your machine guns are your only air-to-air weapons. They can easily destroy other aircraft if you can hit them (which you must learn to do). Balloons are large targets that are easily destroyed if hit; your tracers are really what destroy these hydrogen-filled bags (more about balloon busting on page 56).

Your guns are also useful against targets on the ground, especially targets that are likely to contain fuel or ammunition: trucks, depots, aircraft, guns, and bunkers. To destroy these targets with machine gun fire is possible, but it may take a lot of ammunition. It is best to bomb ground targets (see page 57 for more about bombing).

IMMELMAN TURN

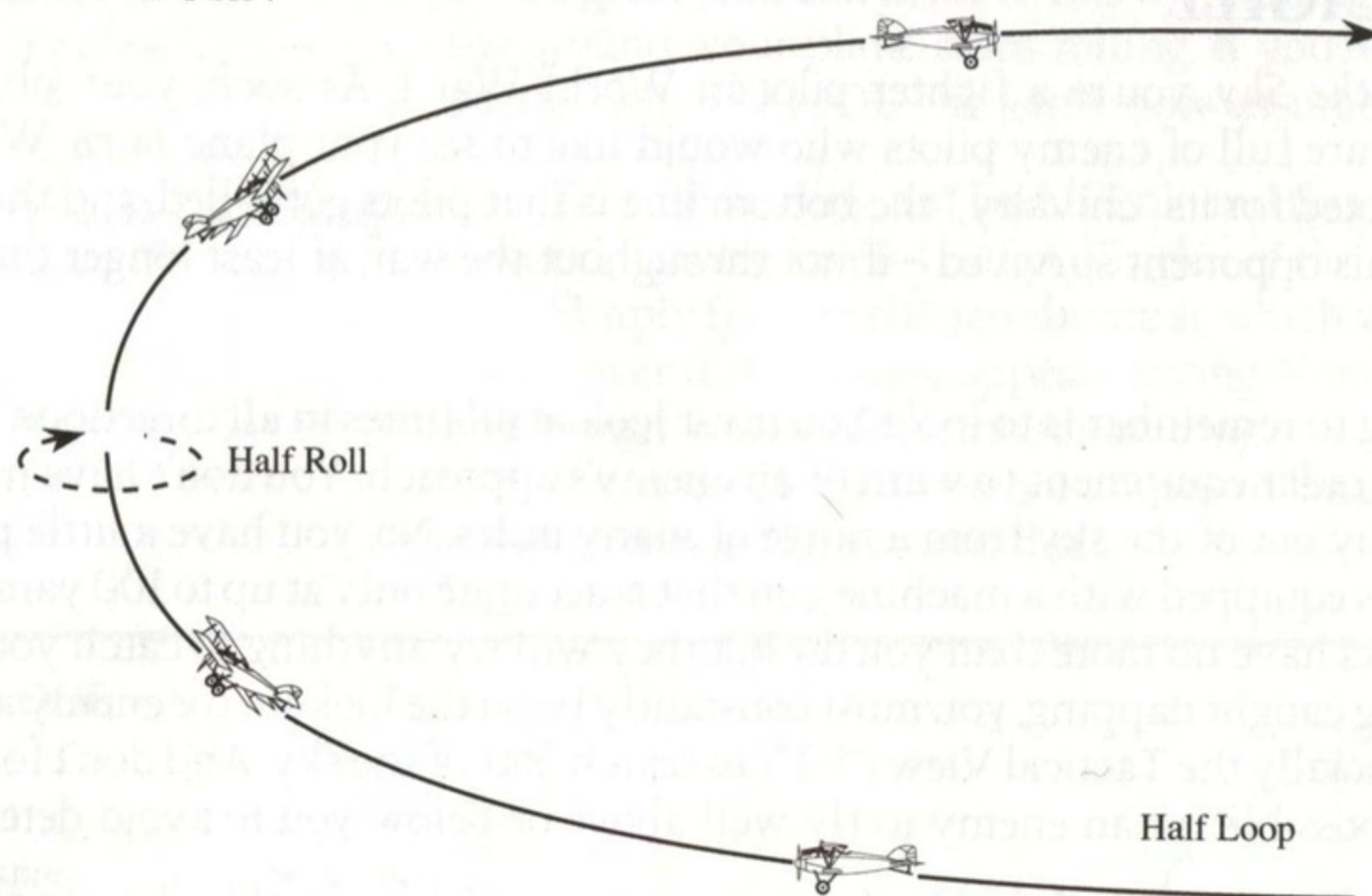

Tradition has it that Max Immelman developed this move, but there's some doubt as to whether the Fokker *eindekker* could have done it. This is usually a 180° change of direction – a climbing turn with a half roll while vertical. The beauty of the move is that rolling while vertical allows a good pilot to finish the half-loop in whatever direction he wants. For example, if you quarter-roll instead of half roll, the overall manoeuvre becomes a 90° change of direction.

Gunsight

To help you fire your machine guns accurately, there's a gunsight that projects into the center of the cockpit view with crosshairs and a circle. This circle indicates the direction a bullet fired right now will travel. To be accurate, therefore, you must *lead* any moving targets you wish to hit.

Strafing

Sometimes you'll want to use your machine guns to attack targets on the ground. The best way to do this is to make a series of strafing runs. Dive low (under 100') then level out to maintain that altitude. The machine gun has a relatively short effective range – about 600' – so don't open fire until you're close enough and right before the target comes into your crosshairs (can't waste your ammunition!).

You don't have a long time to fire, and you don't have much ammo, so making sure you're lined up on the target is very important. It's best to get low to the ground while you're far away from the target and fly the entire run at this altitude.

Be careful though! Many inexperienced pilots suffer from "target fixation;" they ignore altitude and fly right into the ground. Strafing means diving but you've got to come up again – sometime. But when coming up after a dive, be careful not to stall; you're so close to the ground that a stall could prove to be fatal.

Another important point to remember is that there may be enemy fighters in the area, and when you're diving or low, they have an advantage on you that is hard to overcome. They are higher, and therefore faster and more manoeuvrable. In short, don't attack ground targets unless you're convinced that no enemy aircraft are within striking distance – or you think you can handle it.

The Ammunition Factor

Your machine guns do not have an unlimited supply of ammunition. Each time you fire you use some of this precious commodity. There is a counter on the dashboard of your fighter that indicates how many rounds you have remaining. Once your ammunition is used up your guns no longer fire.

Replenishing your Ammo: At difficulty level 1 or 2, you can replenish your ammunition by landing at any Allied Base. At higher levels you must return to your home base. Simply bring the aircraft to a stop on the airfield - without turning the engine off - and ground crews replenish your ammo.

Jams

Sometimes your guns jam. This happens most often when your plane is equipped with Lewis machine guns and is more likely under two circumstances: when you're diving or climbing steeply while firing or when your aircraft is inverted. The firing mechanism relies upon gravity to reload the gun after each round is fired, and a round can get stuck half in and half out of the chamber. The Vickers guns, which equips most of your fighters also jams occasionally, but not as often.

Clearing Jams: When a gun jams, there's only one thing to do: pound the mechanism with your fist and hope the recalcitrant round pops into place. To do this, tap the "U" key. If the jam doesn't clear immediately, you may have to tap the key a few more times. If you're patient, the gun will finally clear and you can continue firing again.

Note: It doesn't matter how hard you strike the key. Be careful, don't damage your keyboard.

SPLIT S

You'll need to practice this one because you'll probably need to use it a lot. This allows you to turn 180° very quickly and gain speed at the same time; the only problem is that you lose altitude. During intense turning battles, when you and your opponent are banking and turning as tightly as possible, and neither of you can see the other, a quick half-roll onto your back followed by pulling back on your stick will usually break the stalemate.

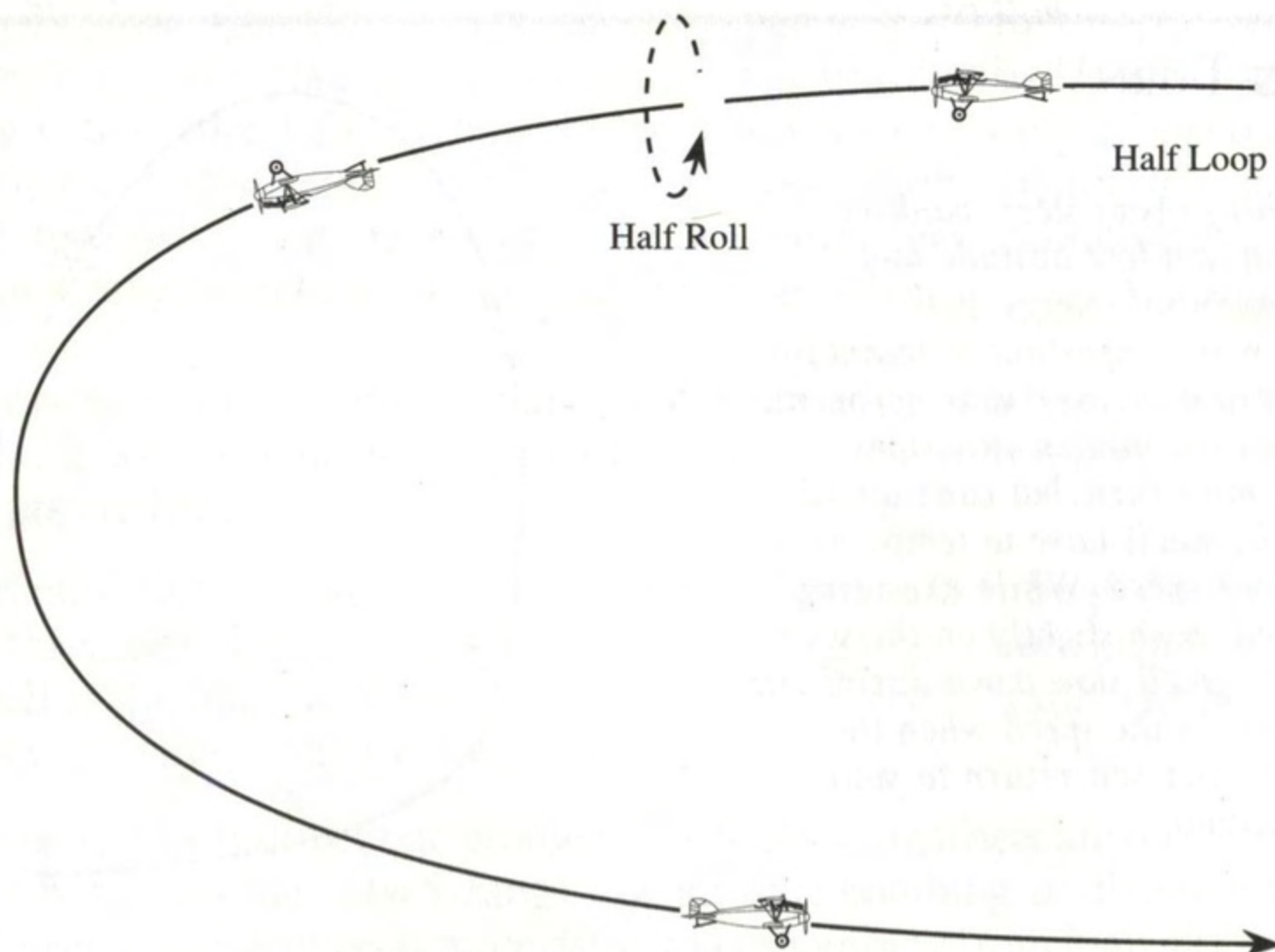

Balloon Busting

Many missions require you to shoot down enemy observation balloons. These may seem like sitting ducks, but they're not. Anti-Aircraft guns surround the base of the balloon site and the balloons themselves certainly will not just sit there and wait for you to come after them.

An observer sits in the basket suspended from beneath the balloon. He is watching enemy troops on the ground and is also searching the sky for enemy aircraft. When he sees you approaching, he'll signal his friends on the ground and they'll start shooting at you. Soon thereafter, the balloon begins to descend, as the ground crew winches it ground-ward; you may see the observer abandon his post by parachuting to the ground if he feels you are getting too close for his comfort. If you attempt to follow the balloon to a low altitude, it becomes more and more dangerous. The closer you get to the ground, the more accurate the fire from the AA batteries.

It's always best to approach balloons from above. The observer is usually looking at the ground, making a map of enemy positions, or taking photos, so he is not likely to see you if you are well above him. This means you'll want to gain lots of altitude before attacking. Additionally, approaching the balloon from enemy territory (from behind him) is most likely to achieve the surprise you want. This, of course, requires flying into enemy territory before making your attack.

Flying Escort

It may seem like a simple matter to escort a recon plane on a patrol or a bomber on a mission. It's not as simple as it may seem. First, these planes are slower than yours, and you can easily out-run them. You'll find that to stay with them you'll have to adjust your throttle, or continually fly circles around them.

CLIMBING TURN

One bad thing about steep, banking turns is that you lose altitude and therefore potential energy. It is sometimes more important to maintain a height advantage over your opponent than to out-turn him. In situations where you must turn, but can't afford to lose altitude, you'll have to temporarily sacrifice some speed. While executing the turn, pull back slightly on the stick as you turn; you'll slow down during the turn, but regain the speed when the turn is done and you return to your original altitude.

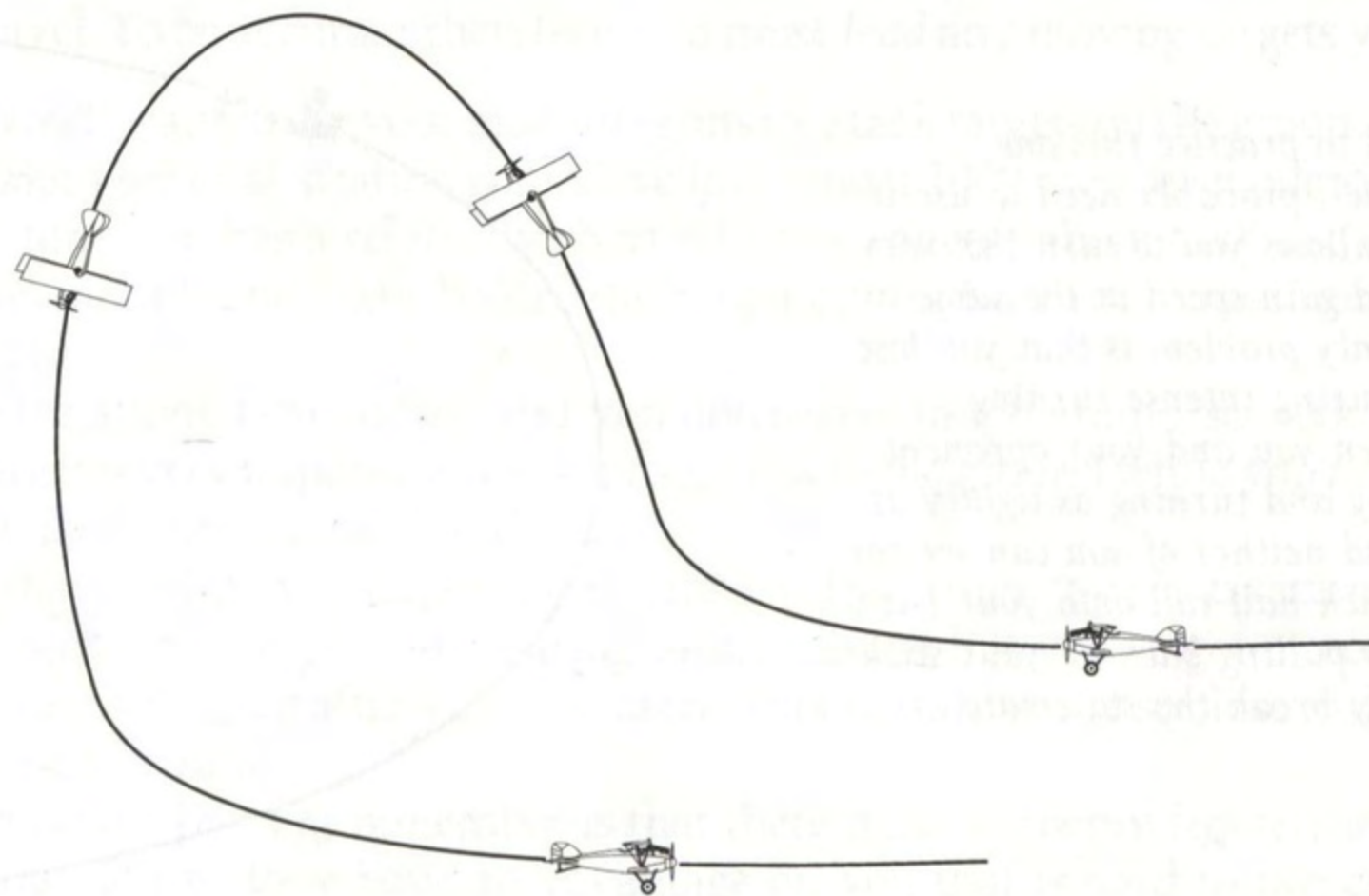

Remember, your primary responsibility is protection of the plane you are escorting. Most experienced pilots recommend gaining altitude immediately after take off. Once you are several hundred feet above the recon/bomber, slow down to roughly his speed. Then keep watch for approaching enemy fighters. This is a good position because you should have a height advantage on any enemies that may attack your friend.

Be careful that you are not being tricked. Sometimes, enemy fighters fly in low to lure you in so that others can dive upon you from above. You must keep a watchful eye.

Attacking Enemy Two- Seaters

You'll often see enemy reconnaissance and bombers flying missions over or near the front. In many cases they'll be escorted by enemy fighters, and you may have to take them on to get to the two-seater. In these cases, the recon/bomber may turn and head for home, while the fighter ties you up in a dogfight.

In some cases, you'll find a recon plane or bomber that is unescorted and you'll have him all to yourself. But be careful; two-seaters can be very dangerous because of their rear-firing machine guns. It's reckless to simply approach one of these from the rear and hope to gun him down; chances are he'll start shooting at you before you get close enough to do any harm.

It's best to approach recon/bomber targets from below, where his machine guns can't fire. It's important to make your final attack from directly below the target so that you can get away after the attack run. Another approach is to dive at them from directly above and hope to attack so fast and furiously as to avoid accurate fire.

Bombing

The Sopwith Triplane, Camel, and Snipe are equipped with 20 lb "Cooper" bombs attached under the fuselage. Your other planes are not equipped to carry bombs. However, many pilots of the day (including you) carried light, high explosive, artillery rounds and dropped them over the side of the plane by hand. Most fighters didn't come equipped with a bomb sight so the bombing was aimed by eye! Obviously, bombing from a fighter was never very accurate, but it was terrifying nevertheless to the unfortunates on the ground. To drop a bomb, tap selector 2 (see the key summary).

You never carry more than 4 bombs of any type. There is no bomb counter to remind you of how many you have left, so you must remember. When you've dropped your fourth bomb, subsequent attempts are fruitless.

The Bombing View

To aid you in making bombing runs, the game has a special "Bombing View" (F3). This view can be very useful because it shows a top down view of your plane from which you can see a wide area in front as well as the shadow of the plane. It is useless to try to bomb a target on the ground when outside this view unless you are dive-bombing

Bombing Techniques

Because accuracy is the number one problem when bombing (there are no electronics devices to help) it's always best to do one of two things: low-altitude bombing, or dive bombing. (It's hard to say which one of these manoeuvres is more dangerous.) Bombing from high altitude (over 1000') is more luck than skill, so don't waste your time!

Low Altitude Bombing: This technique requires you to treat bombing like strafing; simply get low to the ground, switch to your bombing view (F3), wait for your target, then cut loose. That's about all there is to it. The trick is to time the release of the bomb with the speed of the aeroplane.

Dive-bombing: This is probably the most effective way to bomb targets, but it also requires more flying skill.

First you have to identify your target, and this may require being low (see page 34-35 for a description of targets). Then you have to gain altitude so that you can dive at the target for long enough to line up on it. When you're high enough (2000' or more) start diving steeply at the target; when you reach 300' release the bomb then pull up and turn away.

This technique takes a lot of practice but it has two advantages. First, the speed of the dive gains you enough momentum to carry you back high into the sky, so you don't have to be low and vulnerable for a long time. And second, your bombing will probably be more accurate. The drawback is that if you dive too deeply, you may not be able to pull out in time to recover.

Timing the Release

If you're doing a low-altitude bombing run, a good rule of thumb to remember is that the bomb when released has the same forward speed as your aircraft. This means that it will hit the ground at a point that is almost right beneath your plane. The key then is judging how fast you're going and how high you're flying. The shadow of your plane is a good indicator. If you keep a steady course after releasing your bomb, it will land in or near the shadow.

If you're dive bombing, and you're diving directly toward the target, your bomb will hit the target because it falls in the direction you're traveling. The trick is to drop it and pull away before its too late to recover.

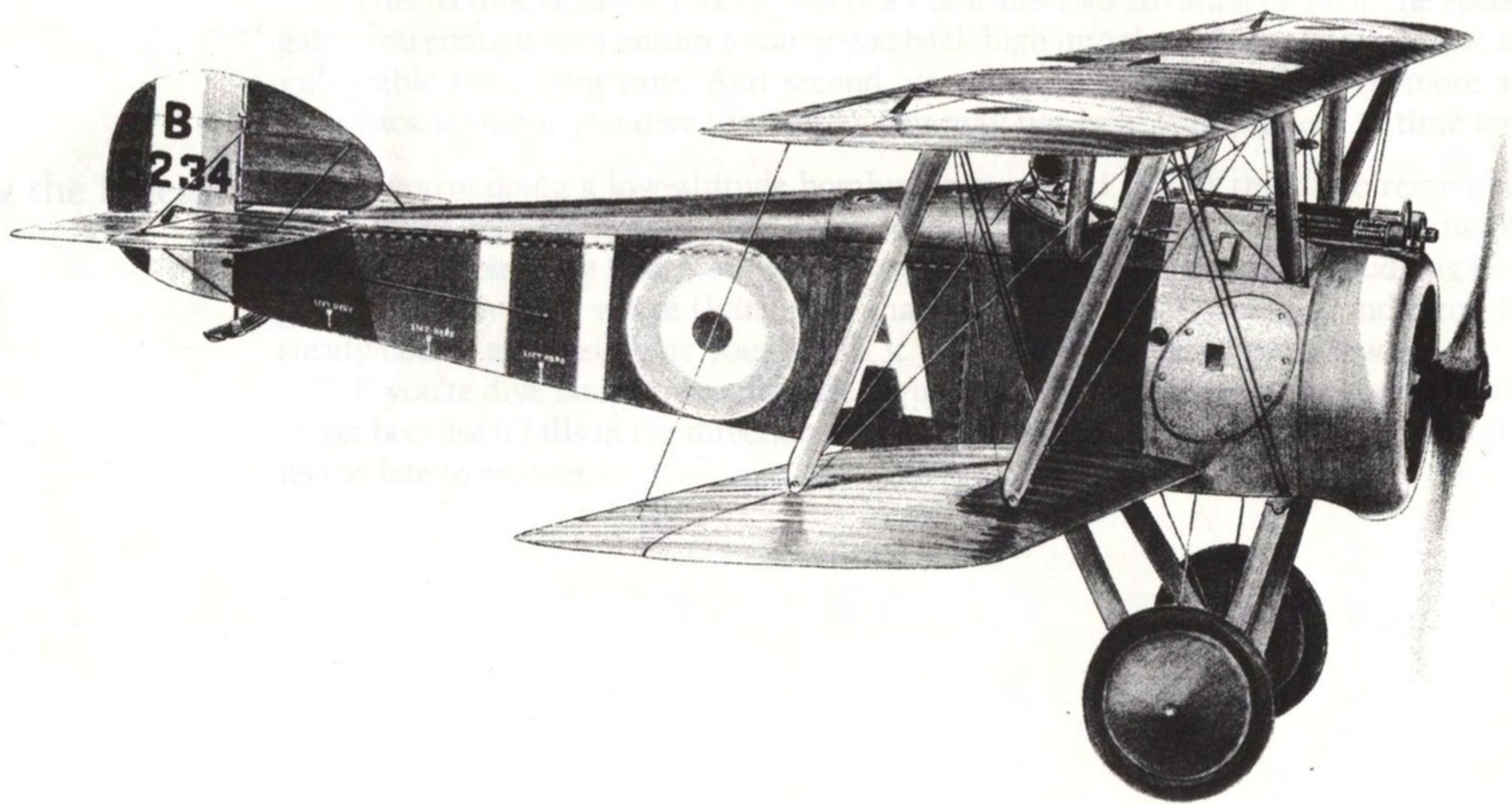

Joe de Massis

SOPWITH F.1 CAMEL (1917)

7. WAR IN THE AIR 1914-1918

THE EARLY DAYS

In 1914, at the outbreak of the first world war, there was little aviation history – and even less of a military aviation tradition. Hardly ten years had passed since Wilbur and Orville Wright – those incorrigible aviation dreamers – had first flown at Kitty Hawk, North Carolina. Those of us who associate the air war of 1914-18 with zooming Spads and spinning Camels probably do not realize that the first military aviators flew machines with top speeds of 60-80 miles per hour – not even as fast as many automobiles of the day. In fact, the first planes on the Western Front in 1914 were little more advanced than the rickety Bleriot that made the first historic crossing of the English Channel in 1909.

Military aviation theory didn't exist in 1914 to any significant degree, but both sides realized that the aeroplane would be a superb intelligence-gathering instrument. Stationary or "captive" balloons had been used as observation platforms during the US Civil War in the early 1860s, and all modern armies continued to use them for high altitude observation of enemy movements and concentrations. It was clear from the beginning of the Great War that the aeroplane would allow not only observation, but exploration of enemy positions in detail, ranging far behind his lines. This new ability facilitated timely reconnaissance reports of enemy movements and relative strengths.

Additionally, the aeroplane might serve the artillery: an observer flying above the target of a bombardment could guide the fire of batteries to achieve optimum results. The French realized early in the war that aeroplanes could also serve as delivery systems for artillery – they would be the first to carry out successful large-scale bombing sorties deep into enemy territory.

In the early days of the war, pilots from both sides flew unarmed. They made reconnaissance flights over enemy columns, reported enemy positions, and in general provided valuable information during the initial German invasion of France. In fact, part of the Allied success in the battle of the Marne, which stopped and turned back German invasion forces from the gates of Paris, is probably attributable to aerial reconnaissance.

BIRTH OF THE FIGHTER AIRCRAFT

After the battle of the Marne, the armies began a series of flanking manoeuvres on the western ends of their lines, designed to get behind the enemy. In essence, the armies raced each other to the sea, each trying to get behind the other. As the lines extended they were entrenched, until an elaborate system of trenches was formed, stretching from Ostende on the English channel to the Swiss frontier. When they ran into the English Channel there was no farther to go, so the armies settled down and glared at each other while they tried to figure out what to do next.

This massive trench system would remain virtually unchanged for the next four years. The areas behind the German lines became German territory and those behind Anglo-French lines were Allied; between the trenches was "no man's land."

The machine gun and the entrenching tool were a large part of the problem. An entrenched army was all but invulnerable to artillery bombardments, and when machine guns were added, it was untouchable by infantry assault as well. The Generals quickly came to the conclusion that the answer was to bombard and assault anyway - but on a very large scale. Week-long artillery bombardments followed by wave after human wave of assaulting infantry, they concluded, was the only way to cut through enemy entrenchments and fortifications.

The problem with this was preparation. In order to bring to bear such awesome firepower on a relatively small portion of the enemy line, huge concentrations of men and materiel had to occur, and this took time. Because these concentrations could not occur overnight, and because it was very difficult to hide hundreds of thousands of men and millions of tons of supplies and equipment, the role of the aeroplane as a reconnaissance tool became ever more important. The trenches themselves provided a solid barrier of secrecy, behind which the armies could manoeuvre and concentrate for an assault. But reconnaissance flights could cancel this secrecy.

It was inevitable that both sides should reflect upon the advantage to be gained if enemy recon flights could be stopped. If one's own troop movements are carried out in secrecy while those of the enemy are widely known, decisive results may be achieved. Enemy recon aircraft had to be destroyed before they reported what they'd seen - or before they saw anything. Obviously the solution was to arm aeroplanes with weapons capable of destroying other aeroplanes.

At first pilots carried pistols, rifles, bricks - even hand grenades - as air-to-air weapons. These implements, however, were little more than useless because it was hard to use them effectively while flying a machine that was lurching and dipping and in general threatening to fall out of the sky with the slightest provocation. Nevertheless, in January of 1915 an Allied flyer, using a carbine, shot down a German reconnaissance aircraft.

The following month Roland Garros, a pre-war stunt pilot, shot down a German machine using a different, much more visionary method. Garros had been experimenting with a direct approach to a problem that both sides desperately wanted solved: how do you mount a machine gun on an aircraft?

ESCADRILLE SOP. 231



There were essentially two types of aircraft at the time: The *pusher* type had the propeller behind the wings and pilot so that the airframe was pushed along through the air. This was a good design for mounting a forward-firing machine gun because there was no propeller in front to obstruct the pilot's view. In fact the fuselage in which the pilot sat was usually a bathtub-like affair that projected well forward of the wings; the pilot had an unobstructed field of fire to the front. However, he had none to the rear. Further, the pusher would never be much faster or more manoeuvrable because of aerodynamic design problems.

Tractor types had the propeller in front of the wings and pilot, at the tip of the fuselage. They had the potential of being much faster and more controllable than any pusher machine. The problem with this design, and the one Garros had addressed in his direct way, was that you couldn't fire a machine gun forward through the arc of the propeller - you'd shoot it off... and if you had the gun mounted so that it would fire outside the arc, your fire would be a lot less accurate. All in all, it was a mess that both sides had been considering for some time, but with little success.

Garros' solution was simple: mount metal plates on the propeller blades and position them so the bullets that strike the blade will not do significant damage. Further, shape these plates to deflect any such bullets away from the pilot. Garros had tried this a couple of times privately and determined that the propeller would be loosened and finally come off after a certain amount of firing. But that would be OK if after each flight or so, the propeller was repaired. It worked in February of 1915: Garros, flying a Morane Saulnier parasol monoplane, with a machine gun that fired through the arc of the propeller, completely changed the course of military aviation.

The Germans, of course, were horrified that the Allies now could fire through the propeller without shooting it off. But they were equally delighted in April, when Garros was forced to land his Morane behind German lines because of a severed fuel line. He tried to destroy the plane before the Germans could grab and study it, but he was too late. The Germans looked at the propeller, scratched their heads, and showed it to the aircraft designer, Anthony Fokker.

Soon thereafter Fokker claimed to have invented a device that would allow German pilots to mount a machine gun on the fuselage, right behind the propeller, and fire directly through the arc without a bullet touching the blades! He proceeded to mount his new device and a Spandau 7.92 light machine gun on a new design that was currently being tested. The tests worked, and the "Fokker Scourge" began.

ESCADRILLE SOP. 207



ESCADRILLE V.B. 135



THE FOKKER SCOURGE

The device itself seems simple to us now, but at the time it was miraculous. Fokker fitted a cam onto the propeller shaft that lifted a rod each time the blade of the propeller was in front of the muzzle of the machine gun. The rod was attached to the firing mechanism and stopped the gun from shooting. So whenever the propeller blades were in danger of being hit by a bullet, the gun would stop firing.

The discovery of the “interrupter gear,” as Fokker’s mechanism was called, came at a time when the German air service needed a boost. They had been on the defensive for the better part of a year, as French Voisin and Farman bombers raided with impunity deep into southern Germany, creating chaos and damage on munitions works in the Saar. As soon as the the new Fokker *eindekker* (single wing) aeroplane appeared, armed with a forward firing machine gun, the tenuous French air superiority ended.

In August, 1915, Max Immelman entered the stage. Immelman was one of the first pilots to receive the new Fokker *eindekker*, and he seemed to know how to use it. On August 1, he shot down a Bristol two-seat bomber from his little *eindekker*. He did this by aiming his plane directly at the enemy plane and shooting as he approached. Not only was it quick, but it was done with such ease and aplomb that the little Fokker monoplane hardly seemed to be bothered by the lumbering bomber or its escorts. This was observed by Allied fliers and set off a round of fear. The Germans, it seemed, had come up with an aircraft that made all others obsolete. Further, and perhaps more alarming, for the first time the Germans were shooting back!

During the following six months the British press and parliament were in an uproar. They felt any hope of air superiority slipping through their fingers as Immelman and a new pilot, Oswald Boelcke, continued to shoot down plane after plane. Immelman, particularly, looked unstoppable. In a few short weeks his score rose dramatically. The German press called him “The Eagle of Lille” because of his skill and daring. It looked as if Allied planes were simply fodder for the Fokkers.

Immelmann and Boelcke became national heroes overnight. German newspapers were full of accounts of their exploits in the sky, and the new German C-type planes (two seat armed reconnaissance machines) looked as if they might be as great a threat as the *eindekker*.

By late autumn of 1915, the Germans, reveling in their new-found aerial prowess, began strengthening their hand even more by organizing their fighter aircraft into single-seat fighter detachments, or *Kampfeinsitzer Kommandos*, allowing them to shift and concentrate air strength more easily and efficiently.

All in all, this entire period might well be characterized by the term *Fokker syndrome*; it was gloomy at best.

2ND ESCADRILLE



THE RACE BEGINS

It is good that gloomy times can produce dramatic, positive change. The Allies, faced with the appalling possibility that German intelligence would be far more accurate than their own, were forced to do some serious thinking about the future and what it might mean for military aviation.

The most immediate effects were felt by French bomber groups that had been operating for so long against so little opposition. During the first half of 1915, while the new *eindekker* was being tested and developed, the French had flown numerous unescorted bombing raids into southern Germany. This wasn't a difficult job, because German machines before the Fokker were not equipped to be aggressive. The German air service was taking a bloody nose politically too for allowing French bombers to penetrate into their homeland.

By Summer of 1915, after the *eindekker* had reached German units in large numbers, these bomber groups began to take losses from enemy fire, a relatively new phenomenon that demanded new measures. The French began escorting their bombers with groups of fighters armed with machine guns that fired to the rear or over the arc of the propeller. The sole purpose of these fighter groups (which the French called *Escadrille de Chasse*, or hunting squadrons) was to protect the bombers as they labored into enemy territory.

By Fall of 1915, losses within these bomber groups became so severe that daylight bombing was discontinued altogether; it was evident that something different had to be tried, so the pilots of these groups began training for night bombing (a technique the French finally did pioneer).

Reconnaissance and defensive activities had to continue, however, and these were daylight affairs. So the Anglo-French adopted a policy of escorting recon planes with one or two fighter aircraft as protection against the Fokker. Since the Germans were still sending out "lone wolves" to hunt Allied reconnaissance flights, maybe the combined fire from the recon's observer and the escorting scout would counter the German technological advantage.

In January, 1916 the British undertook much deeper organizational activities. They grouped aircraft into homogeneous units. *Squadrons* (12 to 15 planes) were organized into *wings* (six squadrons), and wings into *brigades* (three wings). Each army in the British Expeditionary Force (BEF) had an attached brigade to perform reconnaissance, artillery spotting, and bombing. Thus, the idea of fighter formations - probably the most far-reaching response to the Fokker scourge - was born.

In addition to these operational and philosophical changes, Anglo-French industry undertook the design and development of a new generation of fighter aircraft. The first British all-fighter squadron (number 24) arrived in France in February 1916. It was equipped with De Havilland DH 2s, a new single seat pusher-type fighter. With an excellent forward field of fire, it was about as fast and manoeuvrable as any pusher that ever flew. This new aircraft, along with the Vickers Gunbus (FB 5) and FE 2 (both pushers), and the Nieuport 11 (*Bebe*), finally succeeded in ending the Fokker scourge.

ESCADRILLE C. 18

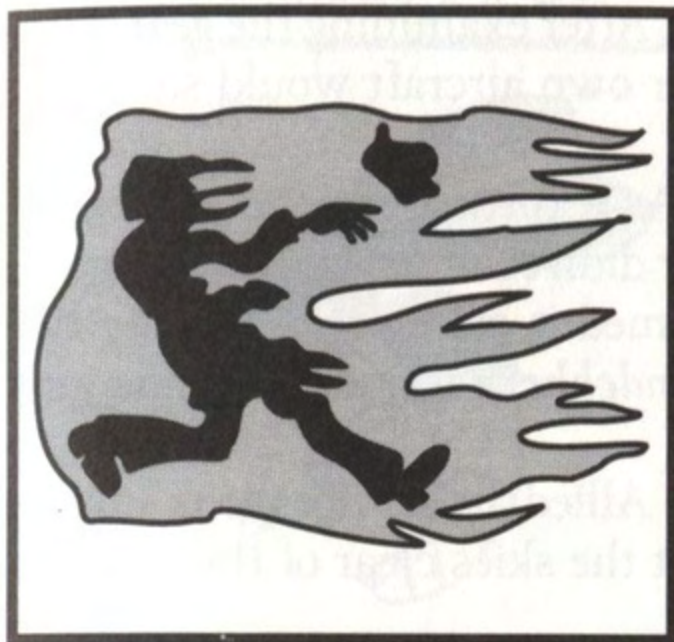

ESCADRILLE AR. 35

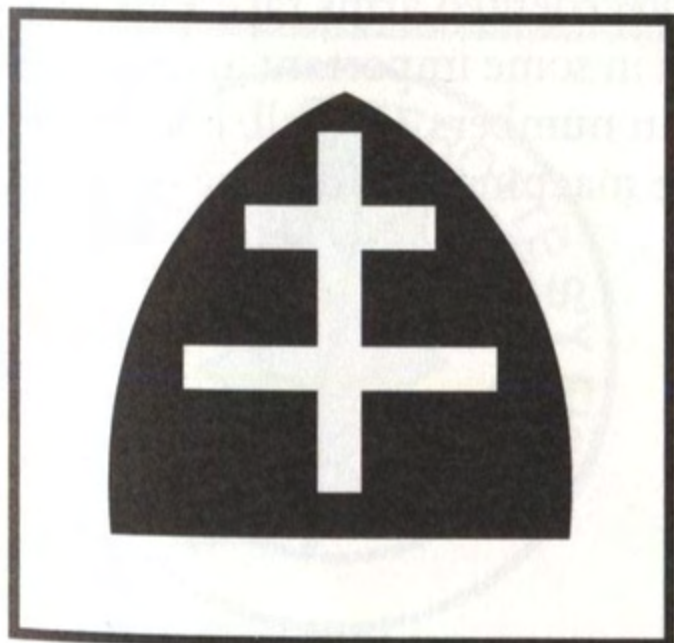

Many accounts of this period give the impression that the Allied technological response was directly linked to the preeminence of the Fokker in the fall of 1915. But, in fact, the new generation of fighters were already flying (in small numbers) or were on the drawing boards before the Fokker scourge began. Most notably, the British FB 5 Gunbus and FE 2b were around at the time, the French Nieuport 11 *Bebe* was about to be released, and the DH 2 was on the drawing boards before Boelcke's first victory in August.

Then, in April, 1916, a lone German pilot flying an *eindekker* became lost in the clouds - it was a very messy day. He landed at a familiar looking aerodrome, but was startled to discover that it was an Allied base. The Allies now had in their hands the answer to the plaguing question of how the German pilots were firing a machine gun directly through the propeller. After examining the gear, they arranged to have trial mock combats to see how performances of their own aircraft would stand up against the *eindekker*.

The results were somewhat surprising and a little humiliating. As it turned out, the *eindekker* wasn't a very good plane. Even against a Morane Parasol, the *eindekker* didn't fair as well as expected. The new French aircraft, the sleek little Nieuport 11 (*Bebe*) outperformed it on every test. Only the lumbering, ill-designed BE 2 fared poorly against the Fokker. The *eindekker's* unique machine gun mounting was all that made it a formidable opponent.

With renewed confidence in themselves and their machines, the Allied air services took up the offensive. The DH 2, the Vickers Gunbus, and the Nieuport *Bebe* swept the skies clear of the dreaded Fokkers, and air superiority swung once again to the west.

On Sunday, June 18, an event that dramatized the end of the Fokker scourge took place in the skies over Annay. Max Immelman, holder of the *Pour le Merite* (the "Blue Max," Germany's highest award), inventor of the Immelman turn, Ace of 15 victories, maker of the Fokker legend itself - the "Eagle of Lille" - went down, taking with him, in a sense, the Fokker Scourge. Immelman's death has never been adequately explained. The Germans said he shot his propeller off due to failure of his interrupter gear; the Allies, of course, claimed he was shot down by a British pilot. The truth will probably never be fully known, but one thing is certain: the era of the Fokker was over and Max Immelman was dead.

To some extent, the Fokker scourge had been blown all out of proportion. The *eindekker* had turned out to be essentially a mediocre plane with a good machine gun on its nose, but it had inspired a rash of theoretical and technological experimentation that had long-lasting positive effects.

This was essentially the story of the rest of the war. It was an unprecedented arms race. One side or the other would develop a new plane that could outdo the opposition in some important arena until a replacement for the outdated machine was developed and produced in numbers. Overall, both sides sustained several periods of "air superiority" before the next innovative machine was developed.

104TH AERO SQUADRON



THE SOMME AND OSWALD BOELCKE

On June 23 of 1916 the British armies under Haig launched a massive offensive in the area of the front north and south of the river Somme. It was designed to end the stalemate that had been achieved after two years of bloody war. The largest and most devastating artillery barrage the world had ever seen was initiated and continued for nearly a week before masses of British infantry came out of their trenches to move through the gap that was to have been created. Unfortunately, the entrenching tool proved mightier than the artillery gun. When the British advanced they were cut down like rows of wheat by German machine gun fire, losing 60,000 men in the first day. The Battle of the Somme would continue like this for nearly 5 months, costing half a million lives.

In the air, with the Fokker Scourge ended, the Allies were able to neutralize German air forces in the battle area over Somme, and had their first harrowing experiences with close support of ground attacks. But the Germans had smelled the end of the scourge and had already taken action that would once again put them in the lead.

Sensing their dominance in the air slipping away in the weeks prior to the Somme Offensive, the German high command had realized that a reorganization of their own forces was in order. Oswald Boelcke proposed reorganization of the *Kampfeinsitzer* into larger units called *Jagdstaffeln*, or pursuit flights. Known as "*Jastas*," these units were smaller than British squadrons or French *Escadrilles*, but were the Imperial Air Service equivalent – a self-accounting unit of up to 18 aircraft. The first *Jastas* were formed in August and September of 1916 and because of the dramatic success of this new formation, 36 were in service by the end of December.

This reorganization of aerial resources was the first step in a program that would re-establish Imperial Air Service dominance on the Western Front from the closing months of the Battle of the Somme until the summer of 1917. This, however, wasn't the only factor that contributed to the new German supremacy; there were two others.

The first was the introduction of a new generation of German fighters to equip the new *Jastas*. Most notable was the Albatros series of fast, heavily armed biplanes. The Albatros D2, which appeared in late August of 1916, revolutionized the concept of the fighter. It was driven by a powerful 160 horsepower inline engine capable of speeds up to 110 miles per hour and was vastly more manoeuvrable than most other fighters. It sported two deadly spandau synchronized machine guns firing through the propeller, and could fly higher than any of its predecessors. This was the first in a long and distinguished line of German fighter aircraft that were to dominate the skies of Europe for the next 12 months.

The second and perhaps more significant factor that would win the Germans superiority was appointment of Oswald Boelcke to command one of the new *Jastas* (*Jasta 2*). Boelcke was the first to codify principles of aerial combat. His rules of engagement, now known to all air forces as "*Dicta Boelcke*," form the basis of dogfight theory as we know it today. Boelcke diligently trained his pilots, watching them carefully during each encounter with the enemy, and constantly criticizing and improving their performance.

ESCADRILLE N. 89



3RD ESCADRILLE



He stressed several key points: keep your eyes on the enemy; always attempt to get to the rear of his machine, because he is helpless under your guns if you are behind him; if dived upon from behind, do not attempt to run, but turn to meet the enemy face to face. Above all, he hammered home the advantage of teamwork, of working together to defeat an opponent - and the theory that it doesn't matter who makes the kill as long as victory is achieved. In short, Boelcke was the first teacher of military aviation, and it was primarily his tutelage that produced the astounding number of high scoring German aces. It should also be pointed out that Boelcke had a keen eye for talent. It was he who recruited Manfred von Richthofen into *Jasta 2* - an appointment that was to have far-reaching consequences.

In the closing days of the Somme, Boelcke's *Jasta 2* went after the enemy with a vengeance. By the end of September Boelcke's score reached 20 and by mid October he had scored his 40th. On Saturday, October 28, 1916, while on a routine interception of enemy DH 2s, the top left wing of Boelcke's Albatros was damaged by collision with the undercarriage of another Albatros of *Jasta 2*. Boelcke's plane went into a long slow glide to earth where it crashed near a German artillery section. Boelcke had not strapped himself into his cockpit in his haste to get off the field; had he been secured, he may have survived his controlled crash. Instead, he died at the height of his power.

7TH ESCADRILLE



BLOODY APRIL

During this period the Allies had grown complacent about their air service. Having attained the qualitative advantage after defeating the "Fokker scourge" they sought now to attain a quantitative advantage that the Germans could never surpass. In so doing they ignored the vital aspect of any arms race, innovation. They continued to produce DH 2s, *Bebes*, and FEs in large numbers even after it was clear that these machines were hopelessly outclassed.

The Allied decision to concentrate upon production instead of innovation didn't mean that no research was ongoing, just that production of new machines was slowed. The Allies developed innovative aircraft during this period, but unfortunately didn't produce them in substantial numbers. As the German technology at the front improved during late 1916 and early 1917, that of the Allies was as mired as the armies at the Somme.

A new offensive was being planned in the area of the front near the Aisne River and it was scheduled to begin in late spring-early summer of 1917. In order to draw enemy troops away from this area, the British were obliged to assault the area around Arras. This offensive was to be supported heavily from the air, and the high command determined that the best way to support the ground troops was to go over to a sustained offensive in the air. Regardless of the knowledge that the Allied air services were outclassed qualitatively, they felt that their sheer numbers would win the day.

Hugh Trenchard, commander of the British Royal Flying Corps, believed the aeroplane could not be used effectively as a purely defensive weapon. He felt that sustained and repeated penetration of enemy territory from the air would tie down enemy aircraft and anti-aircraft guns that would otherwise be used to thwart recon work near the front. If the Allied air services could keep enemy air units away from the front, then so much the better for the offensive on the ground.

Further, if the Allies could maintain initiative in the air while their equipment was inferior, there would be no stopping them when the new generation of fighters (that was just now going into production) became available in the summer. He knew that the Allies had numerical superiority at the moment, and he believed now was the time to use it.

While Trenchard was essentially correct about this, no one, not even he, expected the kind of losses that occurred during the Arras battles. The Allies threw unprecedented numbers of aircraft into the air over Arras and the Germans ate them whole. With so many easy targets the German scoring rate jumped dramatically. The German philosophy during this period was to concentrate as much of their air power as possible near the battle area and fly barrage patrols - patrol their own side of the lines - and wait for the Allies to come to them. That, the Allies did; they were soon referring to this month as "Bloody April."

11TH AERO SQUADRON



ESCADRILLE N. 124



More than 75 Allied aircraft and crews were slaughtered in the first five days of the offensive. Throughout that dreadful month, 316 from a total of 730 aircrew were killed - an appalling 40% kill rate (not including missing, wounded, and grounded). There was staggering wastage as well: over 55 Allied planes crashed and were never recovered. The Germans out-scored the Anglo-French 4-1, even 5-1 in some sectors of the front. All in all, it was a very tough time to be a pilot if you spoke English or French: the average life expectancy was reduced to a matter of hours.

Even with such grievous losses, the Allies won the air war over Arras simply because there were so many of them and German pilots could not be everywhere at once. The Allies were able to fly recon missions, spot for artillery fire, and photograph and map German positions - they fulfilled their ultimate goals even though the Imperial Air Service was deadlier than ever before. By the end of April, attrition began to tell on both sides. The Allied numerical advantage in Nieuport 17s and 11s, Sopwith pups and Triplanes, and Spads 7s paid off. They were victorious, but at what a cost.

In a very real sense, Bloody April was the climax of the first air war. It represented the supreme Allied effort to wrest control of the skies from the hands of the Germans and by sheer numbers they did it. Shortly thereafter, the promised new generation of Allied fighters did appear, and the Germans were never to regain a technological advantage, and could not produce aircraft in the numbers that the industries of France and Britain could.

Nevertheless, in the final days of Bloody April, a German legend was born. *Jasta 11* was combined temporarily with numbers 3, 4, and 33 to form a *Jagdgruppe* (pursuit group) which Manfred von Richthofen commanded. In June, a new organization was formed, the *Jagdgeschwader*. *Jagdgeschwader 1* was formed from *Jastas* 4, 6, 10, and 11 with Richthofen commanding. Its mission was to establish and maintain air supremacy over sectors of the front as directed. So began the legendary career of the "Bloody Red Baron" and his "Flying Circus." The men of this unit were to become national heroes at a time when Germany desperately needed them; they were one of the few bright spots in an otherwise black arena.

90TH AERO SQUADRON

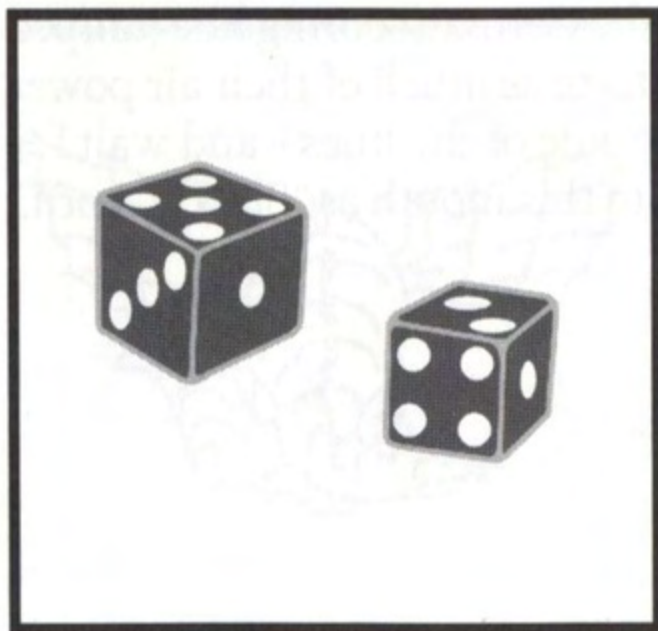

THE NEW FIGHTERS

During the late spring and summer of 1917, the Germans continued to rely upon their excellent Albatros machines, the D2 and newly operational D3 (probably the best of the entire series). In June, the D5 and a little later the D5a were released to the front.

Early in the fall, Anthony Fokker's newest design, the DR1, made it to some of the elite *Jastas*. The first German triplane fighter, it was small, highly manoeuvrable, and as heavily armed as the larger Albatros models. Manfred von Richthofen and Werner Voss, another powerful and skillful German ace, seem to have been particularly fond of this little machine, but most other pilots were disappointed because of structural flaws that made it quite unreliable. This fighter created a lot of anticipation in the months leading up to its release and its popularity and mystique persist even today. But the hope that this plane could stem the Allied air flood was unfounded because of the new generation of Allied fighters that was beginning to make its presence felt.

During the summer of 1917 the new Allied fighters began to appear: fast, manoeuvrable, heavily armed machines that could finally compete with, and in some cases outclass, the best fighters German designers could come up with. The primary aircraft of this generation were the Royal Aircraft Factory's reliable SE 5 and SE 5a, the famous Sopwith F1 "Camel," and the Spad 13. Most earlier Allied fighters had been equipped with a single machine gun, but the new ones, like all the German machines since the *eindekker*, were armed with two. They all sported interrupter gears so the twin machine guns were mounted on the fuselage like the Albatros machines.

All in all, the German technological superiority had ended. They would never again control large sections of the front the way they had during the Fokker scourge or the fall and spring of 1916-17. Only local superiority, made possible by high concentrations of German aces such as was available in Richthofen's Flying Circus, could be obtained from now on.

94TH AERO SQUADRON



186TH AERO SQUADRON



1918: THE END COMES

The final year of the war was marked by long and bitter fighting both on the ground and in the air. The Imperial Air Service was on a long and steady decline, becoming less and less effective as the Allies continued to out-produce them.

During the Spring, German ground forces launched a series of offensives that looked as if they might just turn the war around - more gains were made by these offensives than had been gained in all the battles since the war settled into stalemate in 1914. But in the air, the Allies continued to dominate overall and the Spring offensives became the swan song of the German air forces.

Introduction of new and improved aircraft such as the Fokker D7 and D8 could not hope to regain supremacy from the Camels, Spads, Nieuports, and SE 5s of the Allies. These new Fokkers did divert the end, but the end was inexorably marching closer. The Imperial Air service was being ground into dust under the weight of numbers of the now excellent fighters of the Allied air forces.

When the Spring offensives exhausted themselves and the Americans entered the war with fresh troops and boundless morale, new equipment, and new points of view, the ground fighting went hopelessly against the Germans. There was really nothing the Air Service could do anyway.

During this period, pilots on both sides continued to build their reputations. Men such as Manfred von Richthofen, Ernst Udet, Paul Rene Fonck, Charles Nungesser, William Bishop, and Raymond Collishaw continued to pile up huge scores of enemy planes shot down. But the ultimate outcome of the war was never really in question after the Spring offensives ground to a halt.

It was grim and deadly. Casualties when viewed from a percentage basis were extremely high. Those pilots who gained fame from being the very best - the aces - are a curious point of reference. By war's end the number of dead ones far exceeded the survivors. The aces are certainly considered to be the best of the best, yet the number of the best that survived is small as compared to the number that did not.

In four years aerial operations had come a long way. What in 1914 had been recreation had become an art and a science. Rickety machines that were little more than kites with engines had become, through the crucible of battle, highly tuned specialty aircraft. The seeds of all future military air operations had been planted and had grown considerably since the early days of brick-throwing and pistol shooting.

ESCADRILLE V.R. 292



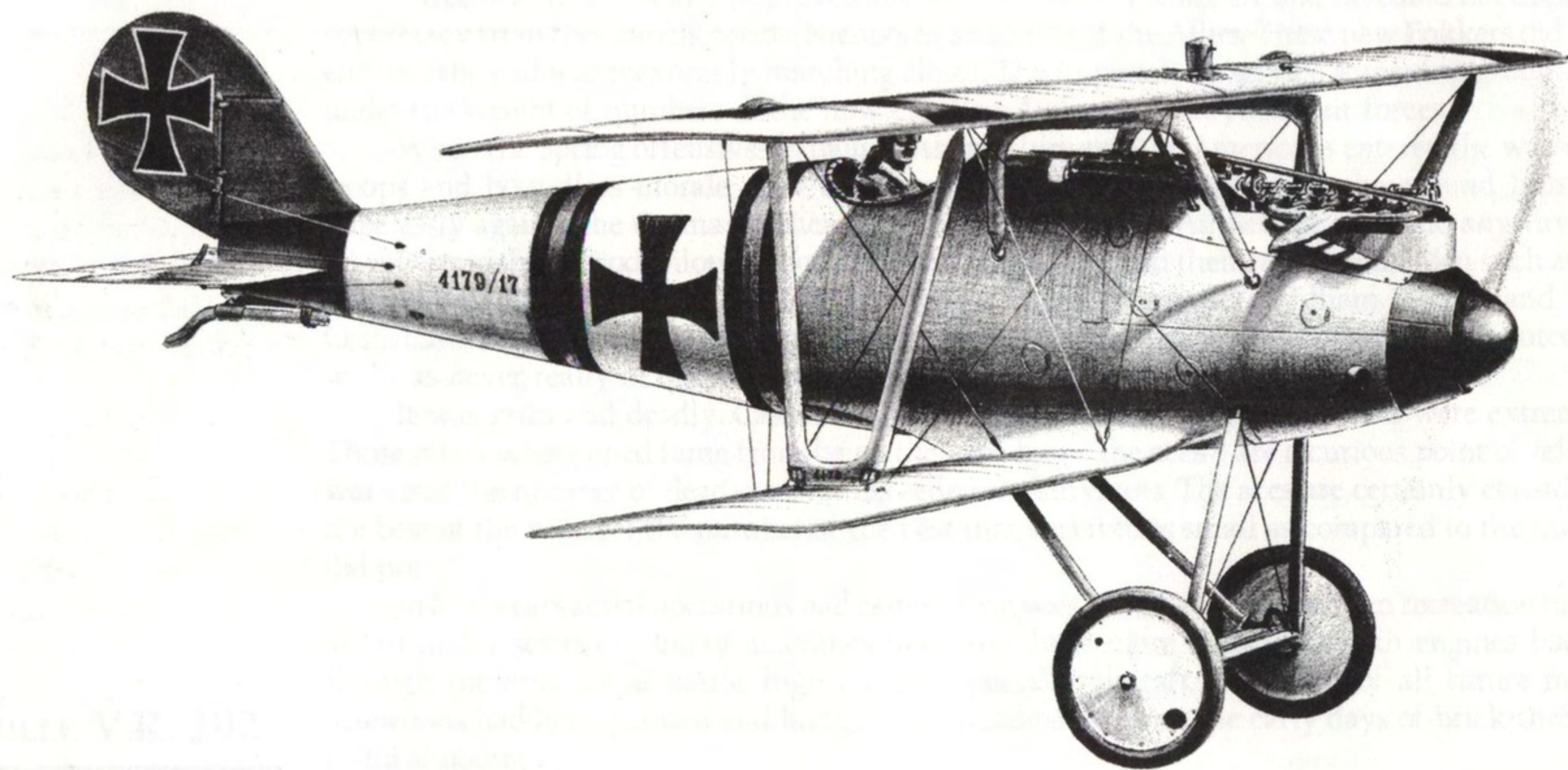

Juan de la Cruz

PFALZ D.III (1917)

8. THE PLANES

ENGINES

Probably the central problem in the design and development of aircraft during the First World War concerned engines. Aero-engines had to be very powerful to pull an aircraft into the sky and keep it there. They also had to perform in various atmospheric conditions; the air at 20,000' is very different from the air on the ground. Finally, if the engine was very heavy, a strong (heavy) airframe had to be constructed to support it - in fact the heavier the airframe the more powerful (and heavy) the engine had to be. In short a balance between the power and weight had to be achieved.

Two basic approaches to these problems emerged before and during the war.

Inline Engine

The Germans developed extremely heavy, powerful, water-cooled aero-engines based upon motor-racing engines made by Mercedes, Benz, and Opel. They realized that a large engine could support a large, strong airframe that would allow a high service ceiling and long range. At the outbreak of the Great War, Germany held both the altitude record (27,500') and the endurance record (24 hours).

With few exceptions, the famous German fighters of the First World War were powered by variants of these water-cooled engines whose cylinders were arranged in a row (in-line). These engines were more reliable at extreme temperatures and high altitudes than the rotary (see below), but of course their weight had a detrimental effect upon handling. Several German companies including Mercedes, Benz, Argus, and BFW produced fine inline aero-engines.

Rotary Engine

The French Spad (*Societe Pour l'Aviation at ses Derivees*) series of excellent fighters, propelled by 150-230 horse power Hispano-Suiza engines, were the first Allied fighters to use inline engines. Later, the British Royal Aircraft Factory produced the famous SE 5 series, powered by a powerful 200 horsepower Hispano-Suiza or Wolseley Viper engine.

The French, the first Europeans to fly, developed the lightest possible engines and the lightest possible frames. By the outbreak of war, they had only one water-cooled engine, but two air-cooled engines, the famous *Gnome* and *Le Rhone* rotaries.

The rotary engine had two advantages and one grave disadvantage. It was very compact and had an excellent power-to-weight ratio, but it had atmospheric intake valves that didn't perform well at high altitude or during extreme weather conditions. Therefore, the service ceiling of most aeroplanes powered by a rotary engine is somewhat less than those powered by inlines and the engines had a tendency to fail in extreme weather.

The cylinders were arranged radially, like bicycle-wheel spokes, and finned for cooling, like the cylinders of a motorcycle engine. It seems strange to us now, but the cylinders and the crankcase revolved around a stationary crankshaft. The propeller revolved around the shaft with the cylinders. Fuel was supplied through the hollow crankshaft by a single jet carburetor. It was a normal four-stroke engine except that current was provided from a stationary magneto and carried to spark plugs at the head of each cylinder via wipe contacts.

Having a rotary engine in the nose of a fighter aircraft produced sharp if delicate handling characteristics. The engine was somewhat like a huge gyroscope that tended to pull the aircraft to one side or the other, giving the aeroplane extremely quick turning capabilities. The unique and superior maneuverability of the Sopwith Camel and Triplane, the Nieuports, and the Fokker DR 1 is due largely to the rotary engine.

Several French and British companies produced fine rotary engines, including Le Rhone, Gnome, and later Clerget. Anthony Fokker's famous rotary-powered aircraft used the German-built Oberursel rotary.

WEAPONS

Machine Guns

Lewis Machine Gun

The Lewis machine gun was the world's first light machine gun. An American design, the US army declined to put it into production but the Europeans bought and produced them in large numbers. It had a rate of fire of about 450 rounds per minute, and the revolving drum mounted above the barrel held 97 rounds of .303-inch ammunition. It was air-cooled and is easily identified by the large cooling jacket encasing the barrel.

Most armed Allied recon aeroplanes were equipped with a Lewis gun on a pivot mount for the observer to fend off air attack. The gun was also fitted to early Allied fighters – the DH 2 and the Nieuport 11. In these cases the machine gun was mounted on a tripod-like mount either above

the top wing to fire over the propeller, or, in the case of a pusher aircraft like the DH 2, in front of the pilot in the nose of the nacelle.

The drawbacks to these arrangements are obvious. First, the gun wasn't mounted so that the pilot could simply aim his plane toward a target and fire; he had to interpret the offset of the gun with the nose of his plane. Secondly, the ammo drum held only enough rounds for a brief encounter with the enemy; when those were gone the pilot had to reload. This in itself is difficult while flying a plane, but in the heat of battle this could be very dangerous indeed.

LEWIS

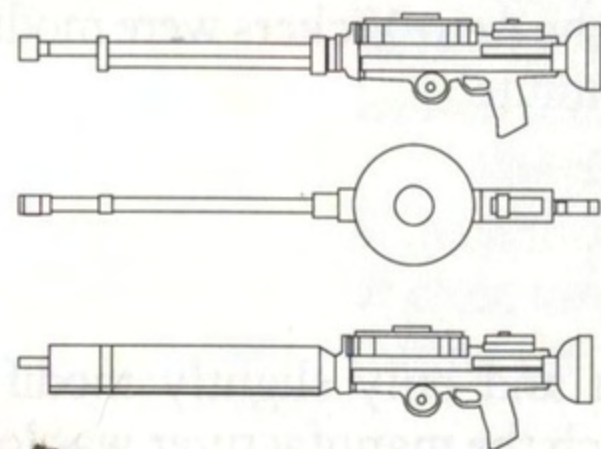

PARABELLUM

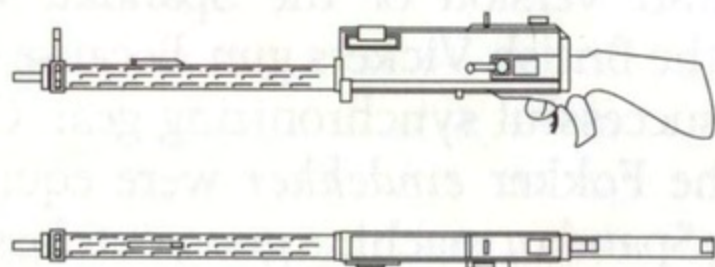

Parabellum Machine Gun

The Parabellum machine gun was the German equivalent to the Allied Lewis. It was drum fed, fired 7.92 mm ammunition, and had a cyclic rate of fire of about 700 rounds per minute. It was used extensively as the observer's gun on armed reconnaissance aircraft. Like the Lewis, it was mounted on a pivot mounting that could be moved from position to position around the ring of the cockpit.

Vickers Machine Gun

The Vickers was the standard British machine gun of the First World War. Derived from the Maxim machine gun (invented by the American Hiram Maxim in 1884), the Vickers was a water-cooled .303-inch machine gun. It was fed from a fabric belt containing 250 rounds and had a cyclic rate of fire of about 450 rounds per minute.

The Vickers, like all machine guns of the day, jammed occasionally, but was otherwise very reliable. Some incredible stories have been told about its employment. In an attack on the High Wood during the Battle of the Somme, 10 Vickers guns are said to have fired nearly a million rounds in a twelve-hour period.

The Vickers was finally attached to a production aircraft (the Sopwith 1 1/2 Strutter) in 1916, using a synchronizing gear. This gun was air-cooled and louvered to facilitate the smooth flow of air over the barrel. Afterwards, nearly all Allied fighters used the Vickers as the forward-firing, synchronized gun. Later in the war some of the Aero-Vickers were modified to fire nearly 1,000 rounds per minute.

VICKERS

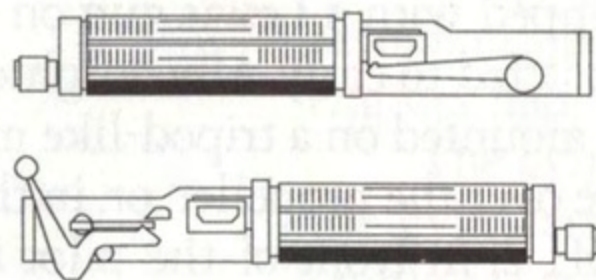

Spandau Machine Gun

Also derived from the Maxim machine gun and only slightly modified, the Spandau machine gun derives its name from the town in which the manufacturer was located. It fired 7.92 ammunition and was a recoil-activated, water-cooled machine gun that was fed from a 250 round fabric belt producing a cyclic rate of fire of up to 600 rounds per minute.

The aircraft version of the Spandau was the German equivalent of the British Vickers gun. Because of Fokker's quick delivery of a successful synchronizing gear, German planes as far back as the Fokker *eindekker* were equipped with fixed, forward firing Spandau machine guns, outclassing any machine gun the Allies were flying at the time. And because of the larger, more powerful engines the Germans utilized, they began mounting twin Spandaus in front of the cockpit well before the Allies could.

SPANDAU

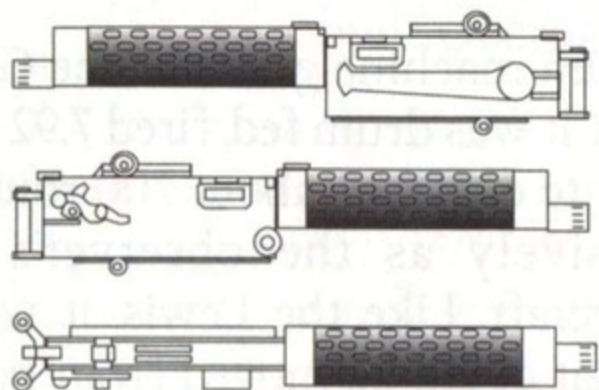

Bombs

During World War I the concept of air-delivery of high explosives was pioneered. By the end of the war, a wide variety of bombs were being manufactured in various sizes. The largest, which could be carried only by the Handley-Page V/1500, was a 3,360 pounder; the smallest was the Cooper Bomb weighing 20 pounds.

The Sopwith planes in the game that are equipped with bombs carry these Cooper bombs. The recon/bomber aircraft that you'll be escorting carries the Royal Aircraft Factory 112 pound bomb.

Rockets

It is not widely known, but some fighter aircraft of the Great War were equipped with air-to-air rockets. These, of course, were not actually used to attack other aeroplanes but to destroy observation balloons. Known as *Le Prieur rockets*, after their designer, the Frenchman Yves Le Prieur, they resembled giant bottle rockets. There was 1.5 feet of casing containing the "warhead" and some propellant charge, and a 3 foot stick which stabilized the rocket in flight. They were fired from tubes suspended on the wing struts, and triggered electrically.

The warhead contained about 200 grams of black powder, and the nose was conical, made of wood, and had a fixed triangular knife blade attached. The rocket didn't explode on contact; rather its sharpened nose penetrated the fabric of the balloon and the fire from the propellant ignited the hydrogen inside.

The planes most commonly associated with rockets are the Nieuports, particularly the 11 and 17. In addition, the Sopwith Pup was often outfitted with them. The accuracy of these rockets, even at close range, was questionable, and they accounted for only a fraction of the balloon kills made during the war.

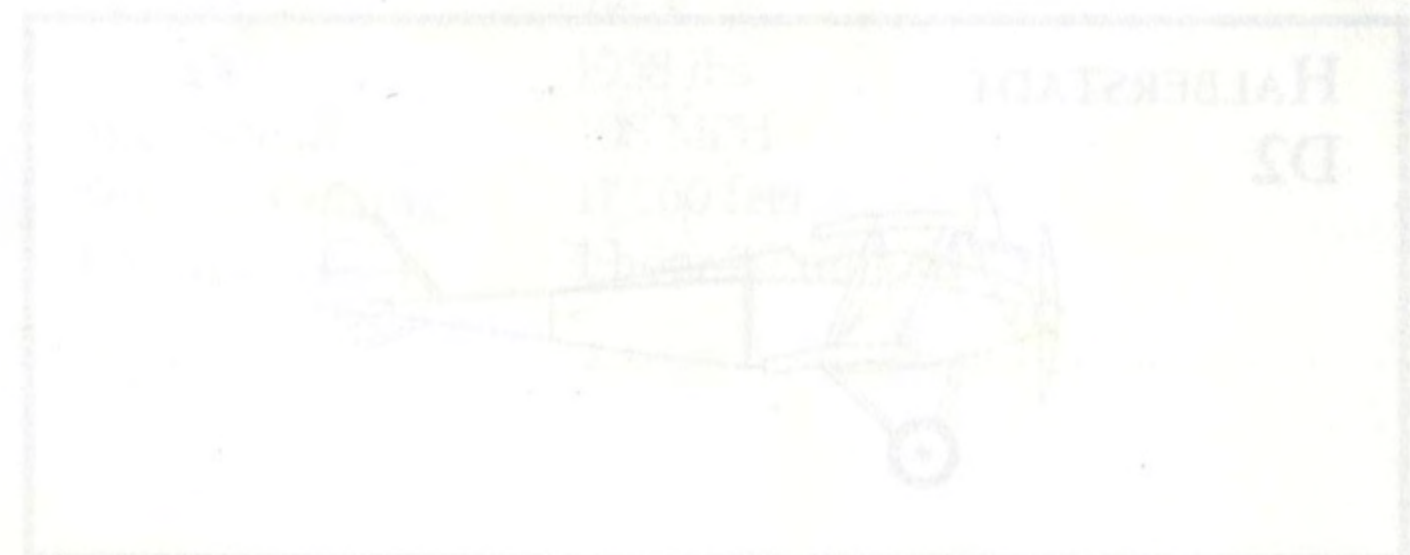
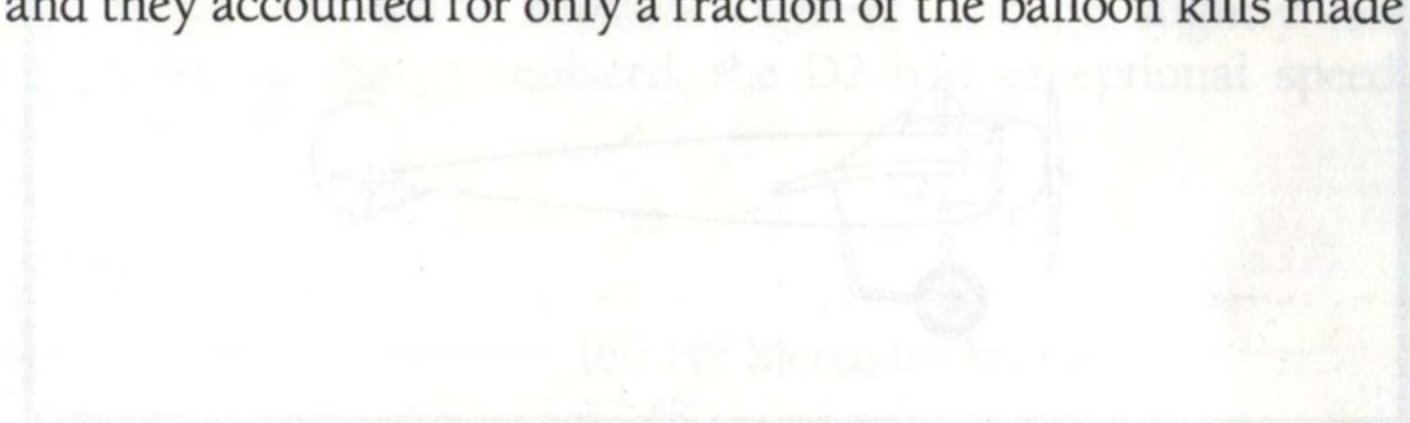

GERMAN FIGHTERS

Based on Fokker's M5 monoplane of 1913 (which in turn was patterned after the Morane-Saulnier series of monoplanes), the Fokker *eindekker* (one wing) was the first aeroplane to be equipped with a machine gun synchronized with the propeller.

The first of the series, the E I, was rushed to the front in June of 1915, but was quickly followed by the E II and E III. The differences between the models in this series were insignificant, and in most cases were not improvements. For example the E II had a smaller wing that actually made it more difficult to fly.

The most numerous version to be produced was the E III (represented in the game) with a wing span greater than the original E I. Over 260 E IIIs were produced. The E series was in service from mid 1915 until late summer of 1916. From early fall of 1915 until spring of 1916 - the period of the "Fokker Scourge" - they reigned virtually unopposed in the skies over the Western Front. After January of 1916 there was finally Allied competition, mainly in the form of the De Havilland DH 2 and the Nieuport 11 "Bebe."

FOKKER E III (EINDEKKER)

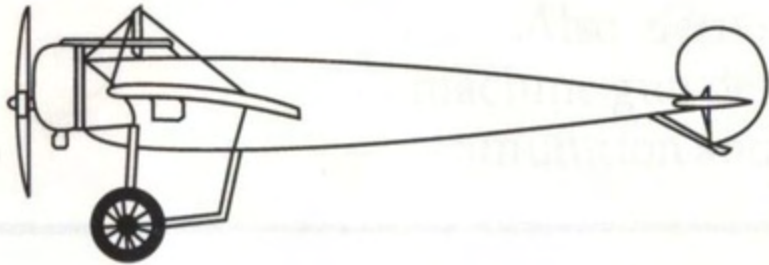

Fokker E III (Eindekker)

Engine:	100 HP Oberursel Rotary
Span:	31' 2.25"
Length:	23' 11.3"
Weight:	1400 lbs
Max Speed:	85 MPH
Service Ceiling:	11,500 feet
Endurance:	2 hours 45 minutes

HALBERSTADT D2

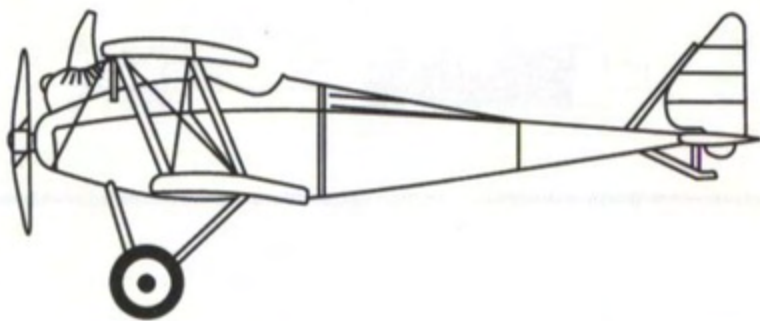

Halberstadt D2

Engine:	120 HP Mercedes Inline
Span:	28' 10.5"
Length:	23' 11.3"
Weight:	1609 lbs
Max Speed:	92 MPH
Service Ceiling:	13,000 feet
Endurance:	1 hour 30 minutes

When it entered service in the summer of 1916 the Halberstadt D2 was intended as an escort for two-seat recon aeroplanes, but it soon joined the newly-released Albatros machines as equipment for the new fighter formations of the Imperial Air Service, the *Jagdstaffeln* (*Jastas*). The Halberstadt fighter, along with Albatros D2s, were primarily responsible for Germany's reclaiming air superiority from the Allied DH 2s and Nieuport 11s after the defeat of the Fokker monoplanes. Peak employment was in January of 1917 when more than 100 D2s were in service at the front.

By the spring of 1916, it was clear that the Allies had the planes (the DH 2 and the Nieuport 11) to defeat the Fokker Scourge. Germany clearly needed a new fighter if it was to regain air supremacy over the Western Front. As a result, the *Albatros Werke* developed a new fighter equipped with two Spandau synchronized machine guns and powered by a 160 horsepower Mercedes inline engine. The combination of the famous Albatros airframe and this powerful engine proved hardy enough to carry the extra weight of the twin machine guns with no degradation of performance, and a new German menace was born.

The Albatros D1 appeared at about the time the Imperial Air Service was forming new organizational units called *Jagdstaffeln* (*Jastas*). So it was natural that this new fighter should equip these new units. But before more than about 50 D1s could make it to the front, Albatros Werke was producing an improved version, the D2. By January 1917 about 215 Albatros D2s were in service with the *Jastas*. At the time, it was probably the best all-around fighter in the world.

The D2 was the first of the highly successful Albatros fighters. Though slightly less maneuverable than the Fokker monoplanes that it replaced, the D2 had exceptional speed, climbing ability, and firepower.

ALBATROS D2

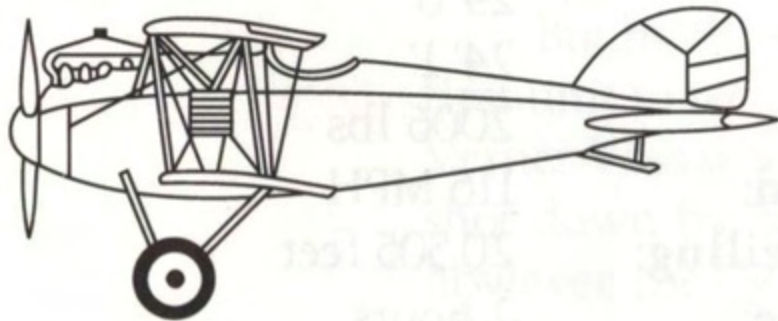

Albatros D2

Engine:	160 HP Mercedes Inline
Span:	27' 11"
Length:	24' 3"
Weight:	1958 lbs
Max Speed:	108 MPH
Service Ceiling:	17,060 feet
Endurance:	1 hour 30 minutes

ALBATROS D3

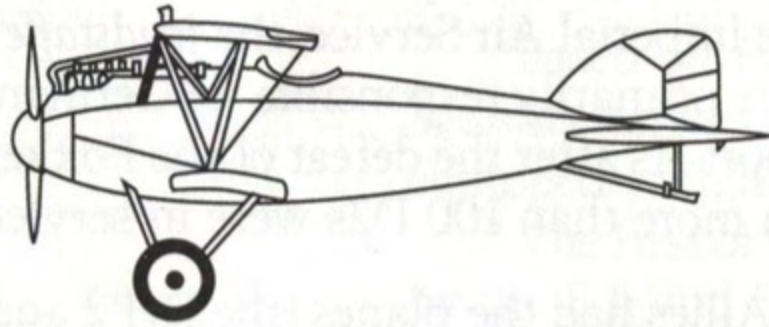

Albatros D3

Engine:	175 HP Mercedes Inline
Span:	29' 8.3"
Length:	24'
Weight:	1953 lbs
Max Speed:	110 MPH
Service Ceiling:	18,045 feet
Endurance:	2 hours

The Albatros D3 was probably the best fighter Albatros produced during the Great War. The design sought to incorporate the best features of the Albatros D2 and the Nieuport fighters that the Germans were so impressed with. The basic airframe of the D2 was retained, but following the Nieuport practice, the lower wing was made much narrower, resulting in an aircraft with better speed and climb than the vaunted D2. As soon as it appeared on the front with the D2s its superiority was apparent.

The D3 first appeared at the front in January of 1917, and by mid spring all 37 *Jastas* at the front were equipped with either D2s or 3s. During April of 1917 - "Bloody April" to the Allies - the D3 was probably the chief source of Allied woes. During the summer of 1917, the D3s began to be replaced by the D5, although production didn't stop until early 1918. By November, over 445 Albatros D3s were at the front.

ALBATROS D5

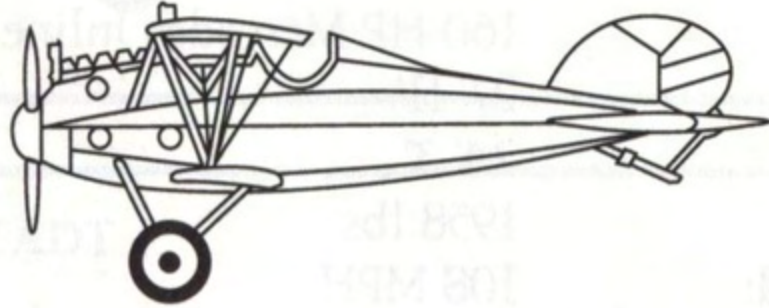

Albatros D5

Engine:	185 HP Mercedes Inline
Span:	29' 8"
Length:	24' 1"
Weight:	2006 lbs
Max Speed:	116 MPH
Service Ceiling:	20,505 feet
Endurance:	2 hours

The Albatros D5 was an attempt to maintain a technological edge after the release of the Allied Sopwith Camel, SE 5, and Spad 13. The German command realized that these were excellent machines that matched the Albatros D3, so the D5 was an attempt to push the envelope of aircraft design a little further.

The D5 was powered by a big 185 horsepower Mercedes engine, slightly more powerful than the earlier D3. Its fuselage was of oval section rather than flat-sided construction, and was lighter but stronger than that of the D3. The overall weight was increased, though, by the larger engine and certain frame-strengthening measures.

All in all, the D5 wasn't a great improvement over the D3. Its flying qualities remained very good, but its success over Allied planes was due more to superior numbers than to superiority of design or performance.

The *Jastas* on the Western Front began receiving the D5 in July of 1917 and reached their service peak between November 1917 and March 1918. At least 1500 D5s were used on the Western Front, although exact production figures are not known.

FOKKER DR 1

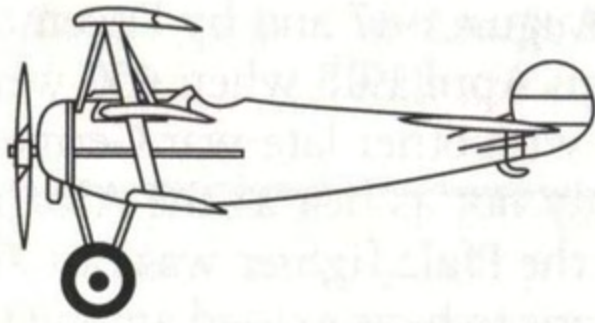

Fokker DR 1

Engine:	110 HP Oberursel Rotary
Span:	27' 8"
Length:	18' 11"
Weight:	1290 lbs
Max Speed:	105 MPH
Service Ceiling:	20,013 feet
Endurance:	1 hour 30 minutes

It is widely believed, and with some credence, that the Fokker Triplane was built in direct response to the Sopwith Triplane which appeared in early 1917. But the designer of the machine, Reinholdt Platz, had never seen the Sopwith version, and in fact wasn't convinced of any merit in the triplane layout.

But by the summer of 1917, 318 DR 1s were ordered. Von Richthofen's "Flying Circus" was the first unit to receive the new aircraft. The "Red Baron" himself was thrilled with the plane, as was Verner Voss who scored 21 victories in the last month of his life flying his Fokker Triplane; he was shot down by an SE 5 in September 1917 after having scored a total of 48. Early in November, however, the DR 1 was grounded in response to a series of fatal crashes occurring because of faulty workmanship in the wing construction; the Fokker factory spent most of that month repairing defective wings. Therefore, the DR 1 didn't become fully operational until early December.

But the high degree of maneuverability inherent in the plane's design, triple wings and heavy 110 horsepower Oberursel rotary engine, made it successful despite these early setbacks. It has often been compared to the Sopwith Camel in terms of handling, and to the Sopwith Triplane for its tremendous climbing capabilities.

During its peak of service in May of 1918, only 171 were in service with frontline *Jastas*. It was a relatively rare experience - despite the myths that all German aces flew them - to see a Fokker Triplane at the front.

PFALZ D3

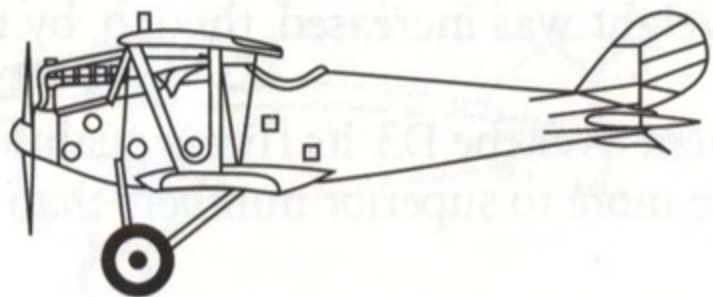

Pfalz D3

Engine:	160 HP Mercedes Inline
Span:	30' 10"
Length:	22' 10"
Weight:	2055 lbs
Max Speed:	105 MPH
Service Ceiling:	17,060 feet
Endurance:	2 hours 30 minutes

Appearing in spring of 1917, the D3 was the first biplane fighter *Pfalz Flugzeug-Werke* produced. It was a well-built machine with an excellent all-around view from the cockpit and was even more shark-like in appearance than the Albatros fighters.

The D3 began to enter service at the front in August 1917 and by December more than 250 were operational. The peak of service was reached in April 1918 when 450 were in service.

The Pfalz's reputation suffered in comparison with other late-war German fighters such as the Fokker D7 and the Albatros D5. It was certainly not as fast as the Albatros and could not perform at the altitudes that the Fokker could. But the Pfalz fighter was fast and maneuverable, well armed and sturdy. Nevertheless, a prejudice seems to have existed among top German pilots, some of whose allegations – structural weakness, and a lack of response – are impossible to justify. The Pfalz could dive harder than any Albatros and so it was used extensively for balloon-busting duties. It could also take more damage than almost any other German fighter.

From spring of 1918 it was gradually replaced by the Fokker D7 and the Albatros D5 but over 60 were still in service at the war's end.

FOKKER D7

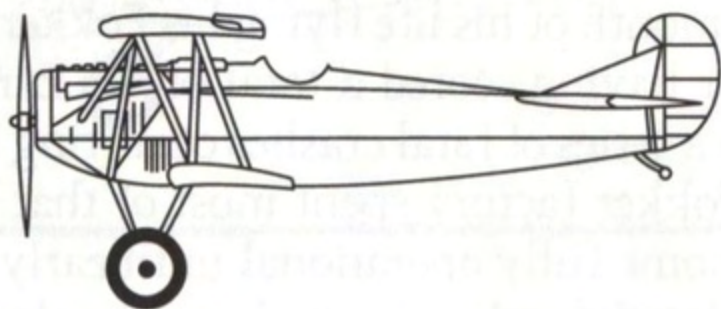

Fokker D7

Engine:	160 HP Mercedes Inline
Span:	29' 2"
Length:	22' 10"
Weight:	1984 lbs
Max Speed:	117 MPH
Service Ceiling:	19,685 feet
Endurance:	1 hour 30 minutes

It is widely claimed that the Fokker D7 was the best German fighter of the war. Some of the early prototypes (the V.II) were found to be unstable during a prolonged dive, so the D7 had a lengthened fuselage and a fixed vertical tail fin. It was armed with twin 7.92 Spandau machine guns with 500 rounds for each gun. Its real strength was its performance at high altitude. While most other fighters began to suffer as altitude neared the service ceiling, that of the D7 was hardly affected.

Manfred von Richthofen strongly recommended that large-scale production of the new fighter be carried out at once. Over 400 were ordered immediately, and this was just the beginning. *Jagdgeschwader I*, Richthofen's "Flying Circus," began receiving them in April of 1918. By the Armistice, 760 had been delivered to 48 *Jastas*. 2,560 D7s were ordered overall from both Fokker and Albatros.

Allied pilots seem to have held the D7 in the same category as the memory of the dreaded *eindekker*. A tribute to the D7, illustrating the respect with which Allied flyers viewed it, appeared in Article IV of the Armistice Agreement: the D7 was singled out by specific mention among military equipment that had to be surrendered to the Allies.

FOKKER D8

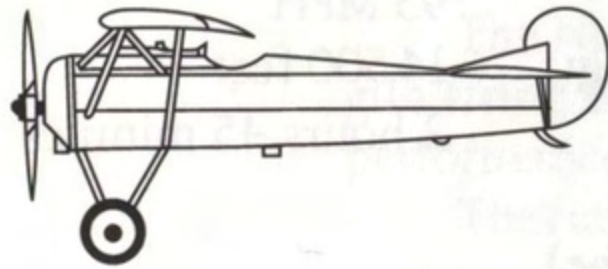

Fokker D8

Engine:	110 HP Oberursel Rotary
Span:	27' 7"
Length:	19' 3"
Weight:	1238 lbs
Max Speed:	115 MPH
Service Ceiling:	20,669 feet
Endurance:	1 hours 30 minutes

The Fokker D8 didn't appear in large numbers until the closing 8 weeks of the war. It is difficult to say what time would have shown about this simple and elegant monoplane design, but reports say that it was easy to fly and was more maneuverable than the D7 – it was as heavily armed and probably would have replaced it.

400 D8s were ordered, but at the beginning of November 1918, only 85 were at the front.

ALLIED FIGHTERS

The DH 2 equipped the first homogeneous unit of the Royal Flying Corps (RFC), number 24 squadron, in February of 1916. A pusher biplane, it was tricky to fly at first but once mastered was extremely maneuverable. It is possible that this aircraft did more than any other plane to overcome the "Fokker Scourge," and by summer of 1916, it had established itself as the best fighter at the front. This dominance was to be short-lived however, because soon thereafter the Imperial Air Service launched the Albatros series. This may be best symbolized by the the events of 23 November, 1916 when Major Lanoe Hawker's DH 2 was shot down by Manfred von Richthofen flying an Albatros D2. The day of the pusher was over.

Withdrawal of the DH 2 from France began in March 1917 and was completed in June.

AIRCO BUILT DE HAVILLAND DH 2

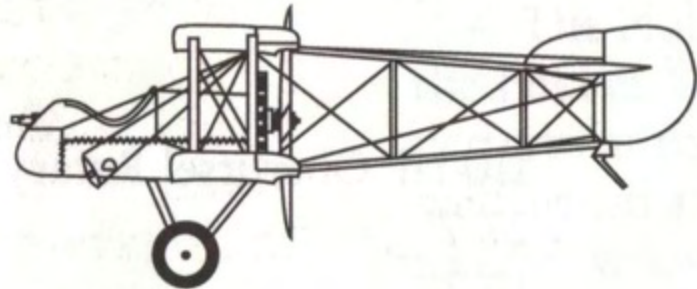

Airco Built De Havilland DH 2

Engine:	100 HP Gnome Monosaupe Rotary
Span:	28' 3"
Length:	25' 2.5"
Weight:	1441 lbs
Max Speed:	93 MPH
Service Ceiling:	14,500 feet
Endurance:	2 hours 45 minutes

NIEUPORT 11 (BEBE)

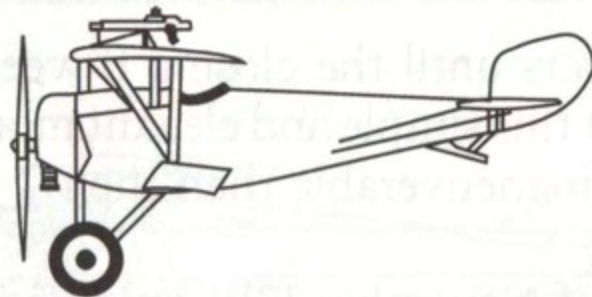

Nieuport 11 (Bebe)

Engine:	80 HP Le Rhone Rotary
Span:	24' 9.25"
Length:	19' 0.3"
Weight:	1058 lbs
Max Speed:	97 MPH
Service Ceiling:	15,092 feet
Endurance:	2 hours 30 minutes

The Nieuport 11 *Bebe* (baby) was originally designed as a racer to compete in the 1914 Gordon Bennet Race. The onset of war cancelled the race but not the plane; it was ordered into production soon thereafter and entered service with the *Aviation Militaire* and Royal Naval Air Service (RNAS) in the summer of 1915. Beginning in March of 1916, they also served with the RFC, sharing with the DH 2 the task of ending the "Fokker Scourge."

At the time, the Allies didn't possess an effective gear for synchronizing machine gun fire with the propeller, so the *Bebe* carried a top-wing-mounted Lewis machine gun that fired over the arc of the air screw. The Nieuport 11 was fast for its day and very maneuverable, making it a good match for the dreaded Fokker *eindekker*.

NIEUPOINT 17

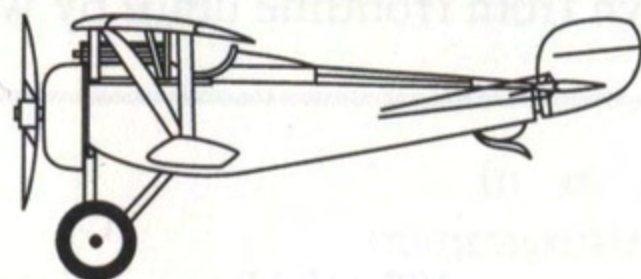

Nieuport 17

Engine:	110 HP Le Rhone Rotary
Span:	26' 11.5"
Length:	18' 10"
Weight:	1246 lbs
Max Speed:	110 MPH
Service Ceiling:	17,388 feet
Endurance:	2 hours

The Nieuport 17 was the worthy successor to the little Nieuport *Bebe*. Its design corrected a few structural problems of the Nieuport 11 and sported a larger engine; it became one of the most popular aircraft among Allied flyers of the entire war. Aces like Ball, Bishop, Guynemer, and Nungesser preferred the Nieuport 17 to almost all other aircraft of the time.

The Nieuport 17 was one of the first Allied aircraft to be fitted with a synchronized machine gun firing through the propeller. Some experiments were made with mounting twin guns, but performance was found to suffer from the additional weight.

The first Nieuports arrived with French *Escadrilles* in May of 1916 and joined British squadrons in the weeks following.

SOPWITH PUP

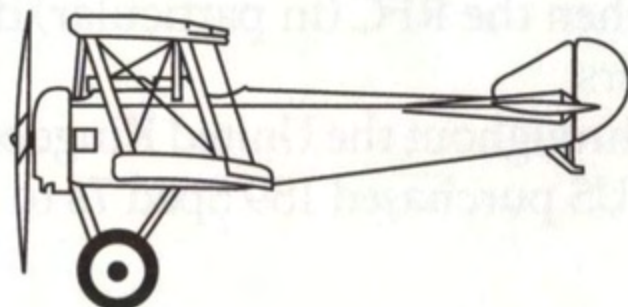

Sopwith Pup

Engine:	80 HP Le Rhone Rotary
Span:	26' 6"
Length:	19' 3.25"
Weight:	1225 lbs
Max Speed:	111 MPH
Service Ceiling:	17,000 feet
Endurance:	3 hours

In Autumn of 1916 the Sopwith and Beardmore companies began shipping their newest fighter. This little plane looked like a scaled-down version of the Sopwith 1 1/2 strutter and thus earned its name, which persisted despite official orders to the contrary. The Pup was beautifully simple in construction and maintenance and its flight characteristics have been called "perfect" and "impeccable." It was rugged and had excellent performance, despite its small 80 HP rotary engine.

Over 1600 Pups were produced and equipped many RFC squadrons and several RNAS squadrons. But by 1918 they began to be withdrawn from frontline units. By war's end they had almost entirely vanished.

SPAD 7

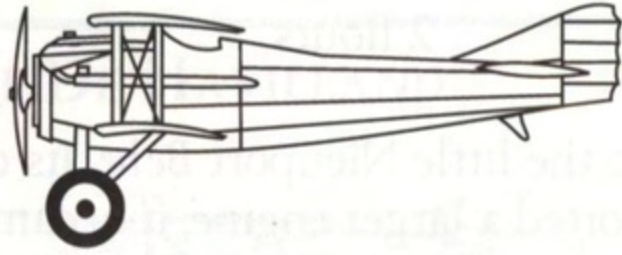

Spad 7

Engine:	150 HP Hispano-Suiza V-type
Span:	25' 7.75"
Length:	20' 2"
Weight:	1632 lbs
Max Speed:	119 MPH
Service Ceiling:	17,500 feet
Endurance:	2 hours 15 minutes

As an alternative to the rotary and inline engines, a Hispano-Suiza engineer developed a new engine configuration for a new line of fighters. This configuration was the V-type and the fighters were the Spads. The first of these new engines was a 150 horsepower V-8. It was placed in a machine known as the Spad 7 in April of 1916. This plane was equipped with a forward-firing synchronized Vickers machine gun and, though less maneuverable than the Nieuports, the Spad was a strong stable gun platform, very fast with excellent climbing abilities.

In the autumn of 1916, it was issued to many French and Belgian *Escadrilles* and by October was in service with the British as well, at a time when the RFC (in particular) desperately needed a more modern plane to replace their aging pushers.

Spad 7s were sent to Italy, Mesopotamia, and throughout the United Kingdom. When the Spad 13 appeared in mid 1917 to replace the Spad 7, the US purchased 189 Spad 7s to equip its fledgling air service.

SOPWITH TRIPLANE

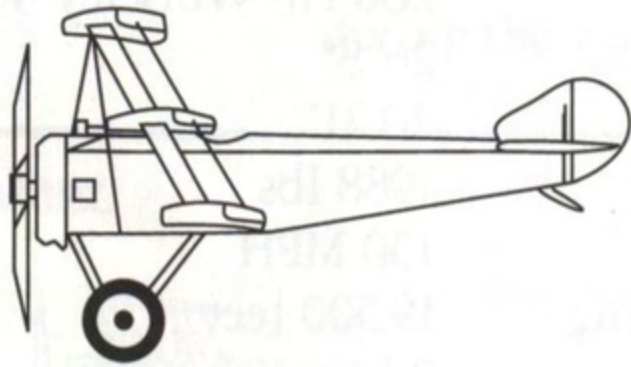

Sopwith Triplane

Engine:	130 HP Clerget Rotary
Span:	26' 6"
Length:	19' 6"
Weight:	1415 lbs
Max Speed:	116 MPH
Service Ceiling:	20,000 feet
Endurance:	2 hours 45 minutes

In an attempt to push the excellent Sopwith Pup design even further and get more maneuverability, speed, and altitude, Sopwith company produced a triplane version in May of 1916. It was quickly nicknamed "Tripe." This version was built around a 110 horsepower Clerget rotary with a centrally mounted Vickers machine gun. The test flights were very successful and resulted in immediate orders from both the RFC and RNAS; in fact, the navy traded its Spad 7s for the new Tripe.

But before these orders could be filled a new version was tested with a 130 horsepower Clerget rotary that was even better, so this became the standard. Deliveries of the Sopwith Triplane began in November of 1916.

The Tripe had an outstanding rate of climb, due to the increased lift provided by the added wing, and was extremely agile and maneuverable, due to the extra control surfaces. The plane had a huge impact on German and Austrian manufacturers, who immediately began tests and trials to produce a model of their own. No fewer than 14 German and Austrian firms produced "answers" to the Sopwith Triplane. The most famous of the answers is the mystical Fokker DR 1.

The Sopwith Triplane was probably as good an aircraft as the Albatros machines, but it was under-gunned as compared to these fighters and was never produced in large enough numbers to curtail the impact of the Albatros.

ROYAL AIRCRAFT FACTORY SE 5A

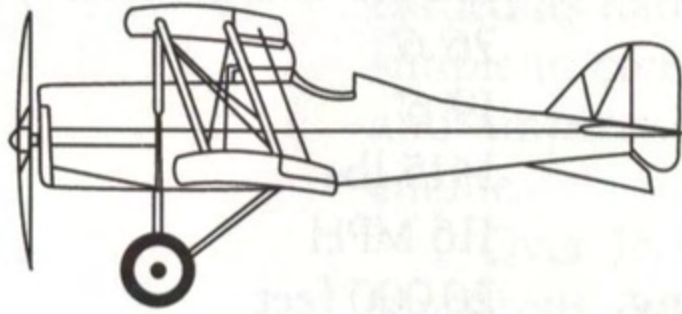

Royal Aircraft Factory SE 5a

Engine:	200 HP Wolseley Viper	Inline
Span:	26' 8"	
Length:	20' 11"	
Weight:	1988 lbs	
Max Speed:	130 MPH	
Service Ceiling:	19,500 feet	
Endurance:	3 hours	

The first deliveries of the RAF SE 5 were made in March of 1917. Although at first the SE 5 was built around a 150 horsepower engine it was later upgraded to a 200 horse model. The plane originally had a partially enclosed cockpit, but this was soon modified at the front, because the pilots claimed the large windscreen affected performance.

The SE 5a was usually equipped with a Vickers machine gun firing through the propeller and a Lewis machine gun mounted on the upper wing. It was faster and sturdier than the Spad and Nieuport, although slightly less maneuverable than the latter. It had excellent high altitude performance, unsurpassed visibility from the cockpit, and good firepower. Along with the Sopwith Camel, which appeared a few months later, the SE 5 is chiefly responsible for regaining Allied air superiority in the summer of 1917, after the disasters of "Bloody April."

SPAD 13

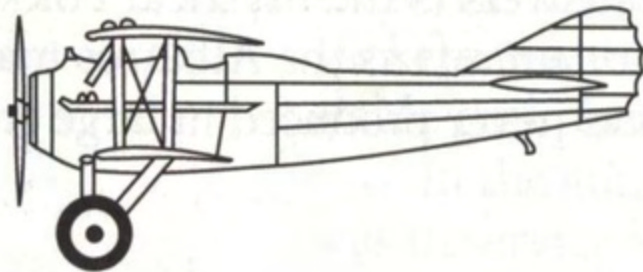

Spad 13

Engine:	235 HP Hispano-Suiza V-type	
Span:	26' 5"	
Length:	20' 5"	
Weight:	1808 lbs	
Max Speed:	135 MPH	
Service Ceiling:	21,818 feet	
Endurance:	2 hours	

The Spad 13 was developed to replace the earlier Spad 7. It was powered by a geared 220 or 235 horsepower Hispano-Suiza V-8 engine and carried two Vickers machine guns firing through the propeller. The first prototype was airborne in April 1917 and it was almost immediately sent into production. The first *Escadrilles* received Spad 13s by the end of May and by the war's end over 8400 had been produced. Before the end of the war it had replaced almost every Spad 7 and Nieuport 27. Virtually all French *Escadrilles* eventually received Spad 13s and at least one Squadron of the RFC was equipped with this fine aeroplane.

Although difficult to fly at low speeds, it was extremely sturdy, heavily armed, and very fast by the standards of the day. The Spad 13 was probably the most successful French fighter built during the war.

SOPWITH CAMEL

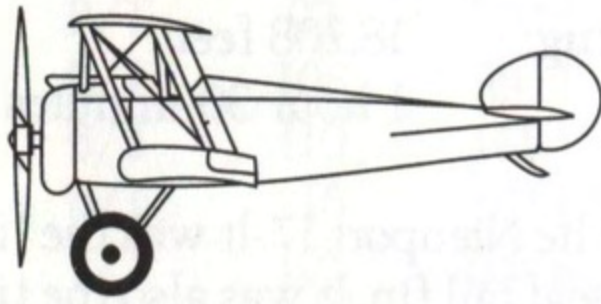

Sopwith Camel

Engine:	130 HP Bentley Rotary
Span:	28'
Length:	18' 9"
Weight:	1482 lbs
Max Speed:	115 MPH
Service Ceiling:	18,000 feet
Endurance:	2 hours 30 minutes

The Sopwith Camel has the distinction of having destroyed more enemy aircraft than any other Allied type. The successor of the Pup and Tripe, the Camel had none of the easy handling that its predecessors had. It had a very heavy 130 horsepower engine acting like a huge gyroscope; it could out-turn any German fighter (with the possible exception of the Fokker Triplane). The nickname comes from its slightly hump-backed appearance created by the cowling over the twin Vickers machine guns in its nose.

During the 3rd Battle of Ypres and the Battle of Cambrai, the Camel was used extensively for ground support activities. Carrying four 20 pound bombs under the fuselage and armed with twin Vickers machine guns, the Camel was a fearsome fighter. But its real strength was in its dogfighting capabilities. Its tremendous turning finesse, speed, and simplicity of construction (and therefore maintenance) made it the most reliable fighter on the Allied side.

The prototype was produced in December of 1916 with a 110 horsepower Clerget rotary engine. But the production model, which began appearing in RFC squadrons about July 1917, was built around a 130 horsepower Clerget 9 B rotary engine. By January 1918 there were over 1300 Camels at the front and over 2100 more on order. On September 1, 1918 there were 2548 Camels in service at the front. In all over 5490 Camels were ordered.

NIEUPORT 27

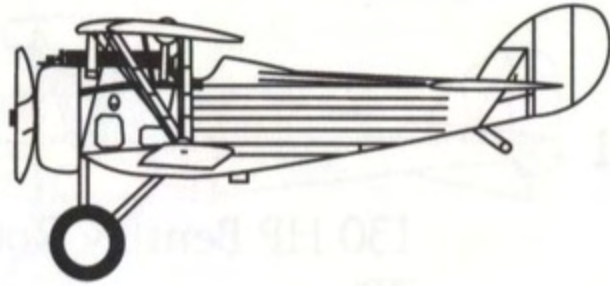

Nieuport 27

Engine:	120 HP Le Rhone Rotary
Span:	26' 11"
Length:	19' 2"
Weight:	1289 lbs
Max Speed:	116 MPH
Service Ceiling:	18,208 feet
Endurance:	1 hour 30 minutes

The Nieuport 27 was the logical successor to the Nieuport 17. It was the first Nieuport fighter to have a circular section fuselage and a fixed vertical tail fin. It was also the first Nieuport fighter to have twin synchronized Vickers machine guns.

The Nieuport 27 never really competed with its earlier cousin the 17, and few made it to the front; Allied pilots preferred the Spad 13. The US bought most of the nearly 400 that were built.

SOPWITH SNIPE

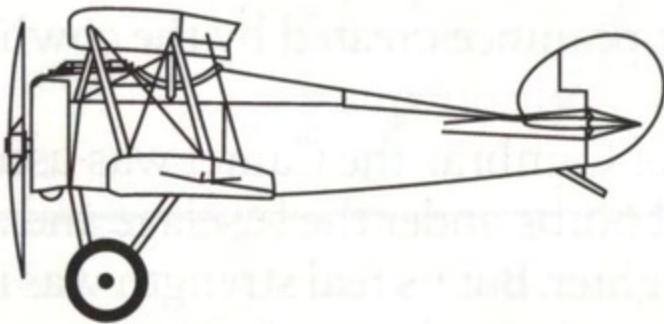

Sopwith Snipe

Engine:	230 HP Bentley Rotary
Span:	30'
Length:	19' 2"
Weight:	2020 lbs
Max Speed:	130 MPH
Service Ceiling:	19,500 feet
Endurance:	3 hours

The Snipe was built to replace the Camel. Based on the "look" of the Camel, the Snipe was faster, could fly higher, handled more easily, and had improved view from the cockpit. Like the Camel, its twin synchronized Vickers machine guns were complemented by the Snipe's ability to carry four bombs beneath the fuselage.

What more could you want?

The prototypes were ordered in late summer of 1917, and the final version went into production during the spring of 1918. Over 1700 Snipes were ordered initially. Deliveries didn't begin until mid-summer, and by the end of September no more than 160 had been delivered. The plane became operational at the front in September.

The Snipe, had its service been longer, would probably have proven to be the most successful fighter the Allies produced.

COMPARISON OF THE AEROPLANES

German Fighters

Plane	Type	Speed	Eng	Ceil	End	Main Arm	Len	Wing	Nat
Fokker Eindexer	M/T	85	100 R	12K	2.8	1 Spandau	24	32	G
Halberstadt D2	B/T	92	120 I	13K	1.5	1 Spandau	24	29	G
Albatros D2	B/T	108	160 I	17K	1.5	2 Spandau	24	28	G
Albatros D3	B/T	110	175 I	18K	2.0	2 Spandau	24	30	G
Albatros D5	B/T	116	185 I	20K	2.0	2 Spandau	24	30	G
Fokker DR 1	T/T	105	110 R	20K	1.5	2 Spandau	19	28	G
Pfalz D3	B/T	105	160 I	17K	2.5	2 Spandau	23	31	G
Fokker D7	B/T	117	160 I	20K	1.5	2 Spandau	23	29	G
Fokker D8	M/T	115	110 R	21K	1.5	2 Spandau	19	28	G

Anglo-French Fighters

Plane	Type	Speed	Eng	Ceil	End	Main Arm	Len	Wing	Nat
DH 2	B/P	93	100 R	15.K	2.8	1 Lewis	25	28	B
Nieuport 11	B/T	97	80 R	15.K	2.5	1 Lewis	19	25	F
Nieuport 17	B/T	110	110 R	17.K	2.0	1 Vickers	19	27	F
Sopwith Pup	B/T	111	80 R	17.K	3.0	1 Vickers	19	27	B
Spad 7	B/T	119	150 V	18.K	2.3	1 Vickers	20	26	F
Sopwith Triplane	T/T	115	130 R	20.K	2.8	1 Vickers	20	27	B
RAF SE 5a	B/T	130	200 I	20.K	3.0	1 Vickers	21	27	B
Spad 13	B/T	135	220 V	22.K	2.0	2 Vickers	20	26	F
Sopwith Camel	B/T	115	130 R	18.K	2.5	2 Vickers	19	28	B
Nieuport 27	B/T	116	120 R	18.K	1.5	2 Vickers	19	27	F
Sopwith Snipe	B/T	130	230 R	20.K	3.0	2 Vickers	19	30	B

Key













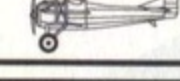

Type:	<i>Wing/Mode</i>	T=Triplane;B=Biplane;M=Monoplane/P=Pusher;T=Tractor
Speed:	<i>Maximum speed</i>	Measured in miles per hour.
Eng:	<i>Engine</i>	The size (in horsepower) and type (Rotary [R], Inline [I], or V-type [V]).
Ceil:	<i>Service ceiling</i>	The highest the plane can fly and still function normally.
End:	<i>Endurance</i>	The length of time in hours the plane can fly without exhausting its fuel.
Main Arm:	<i>Main Armament</i>	The main forward-firing machine gun armament.
Len:	<i>Length</i>	Length in feet (rounded up).
Wing:	<i>Wing Span</i>	Measured in feet (rounded up).
Nat:	<i>Nationality</i>	Country of manufacture. G=Germany; F=France; B=Britain.

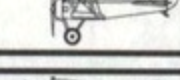
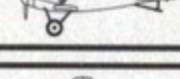
FIGHTER APPEARANCE CHART

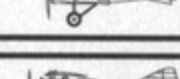
The following chart lists all fighters in the game and shows the service period for each. The start and end dates for each plane are approximations at best, but give a clear picture of the turnover of aircraft and the race for technological supremacy.

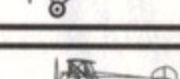
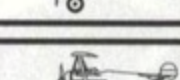
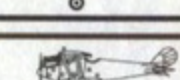
Plane	Service Period	Main Arm	Top Speed	Altitude
Spad VII	1917-1918	1 motor	110 mph	10,000 ft
Spad XIII	1917-1918	1 motor	110 mph	10,000 ft
Spad XIV	1917-1918	1 motor	110 mph	10,000 ft
Spad XV	1917-1918	1 motor	110 mph	10,000 ft
Spad XVI	1917-1918	1 motor	110 mph	10,000 ft
Spad XVII	1917-1918	1 motor	110 mph	10,000 ft
Spad XVIII	1917-1918	1 motor	110 mph	10,000 ft
Spad XIX	1917-1918	1 motor	110 mph	10,000 ft
Spad XX	1917-1918	1 motor	110 mph	10,000 ft
Spad XXI	1917-1918	1 motor	110 mph	10,000 ft
Spad XXII	1917-1918	1 motor	110 mph	10,000 ft
Spad XXIII	1917-1918	1 motor	110 mph	10,000 ft
Spad XXIV	1917-1918	1 motor	110 mph	10,000 ft
Spad XXV	1917-1918	1 motor	110 mph	10,000 ft
Spad XXVI	1917-1918	1 motor	110 mph	10,000 ft
Spad XXVII	1917-1918	1 motor	110 mph	10,000 ft
Spad XXVIII	1917-1918	1 motor	110 mph	10,000 ft
Spad XXIX	1917-1918	1 motor	110 mph	10,000 ft
Spad XXX	1917-1918	1 motor	110 mph	10,000 ft

FIGHTER APPEARANCE CHART

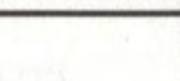
	1916	1917	1918
Fokker E III 	■		
Airco DH 2 	■	■	
Nieuport 11 	■	■	
Halberstadt D2 	■	■	
Nieuport 17 	■	■	
Spad 7 	■	■	■
Albatros D2 	■	■	
Sopwith Pup 	■	■	
Albatros D3 		■	■
Sopwith Triplane 		■	
SE 5a 		■	■
Spad 13 		■	■
Albatros D5 		■	■
Sopwith Camel 		■	■
Fokker DR 1 		■	■
Pfalz D3 		■	■
Nieuport 27 			■
Fokker D7 			■
Fokker D8 			■
Sopwith Snipe 			■
	May June July August September October November December	January February March April May June July August September October November December	January February March April May June July August September October November December

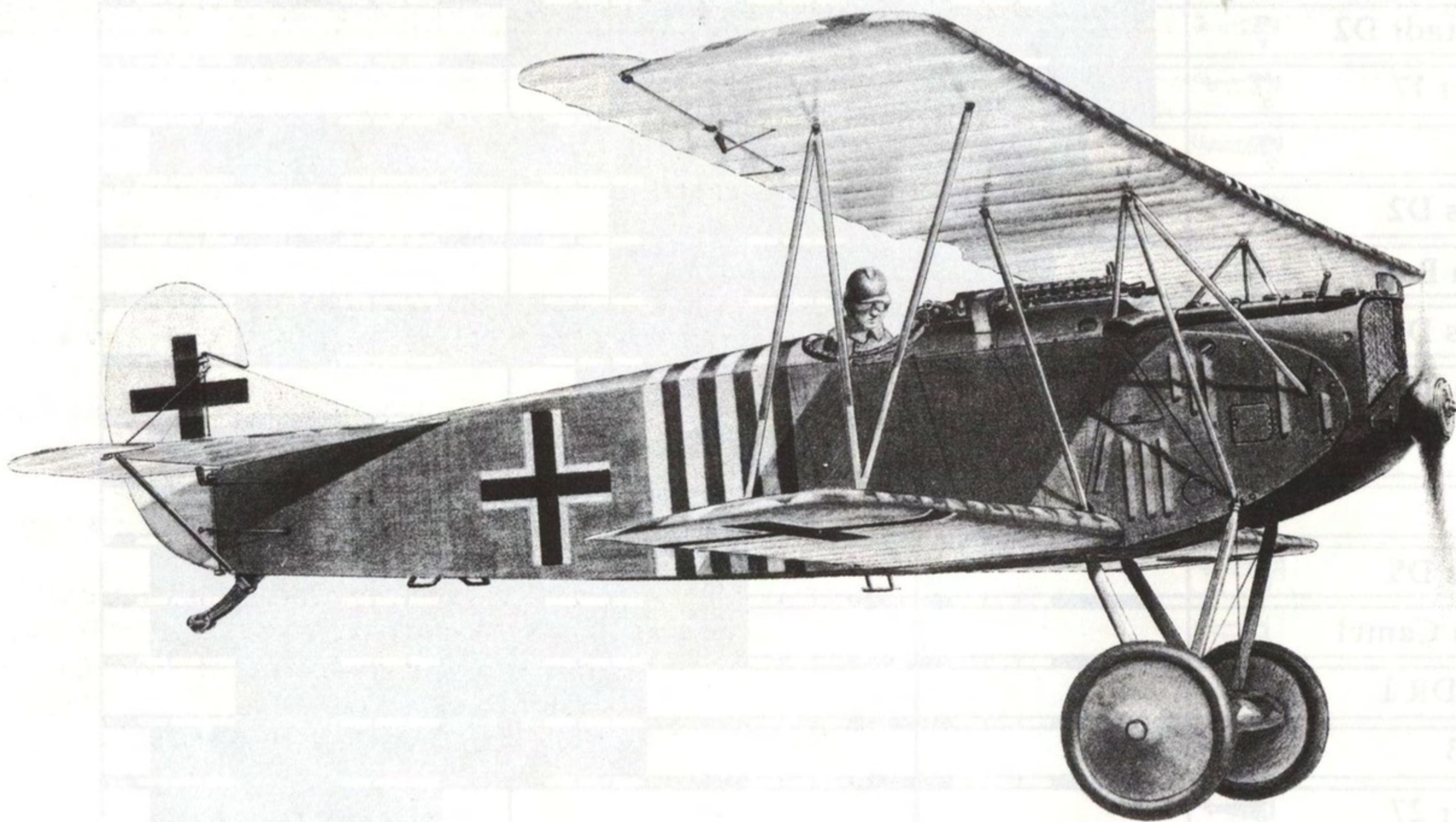

Joe M. ...

FOKKER D.VII (1918)

DESIGNER'S NOTES

DO WE HAVE THE TECHNOLOGY?

For a long time, the people at MPS Labs had kicked around the idea of doing a World War I flight simulator. It seemed like a natural – but there were a couple of problems: topic appeal and technology.

The general consensus was that most people like to fly jets... Well, we've done a lot of "jet-games" and found that to be true – a whole lot of people *do* like flying jets. But why wouldn't they *also* like flying biplanes?

Well, that's where the technology issue came in. We thought a lot of folks *would* like biplanes if the planes could look good. Biplanes are very complex objects – not like sleek jets, with smooth, polygonal surfaces. Biplanes are angular contraptions with wheels sticking out the bottom and stacked wings. It takes lots of very complex, efficient 3D code to render good-looking biplanes spinning and zooming around the screen.

To make matters worse, dogfighting in those days was a personal affair. You couldn't coldly fire a missile from miles away and watch a tiny jet-shaped object turn to a ball of flames. No, you had to get up close to the enemy, follow him for a long time, line him up, and shoot him down with your guns. This means that not only does the program have to draw these real complex objects, but it has to draw 'em big, and keep doing it for a long time. This is hard! ...Especially if you're interested in having the whole thing look good and run fast.

Fortunately, MicroProse has been in the 3D graphics biz as long as anyone, and we have guys who can do these things. After seeing what Scott Spanburg and Andy Hollis did with *M1 Tank Platoon* and *F-15 II*, we were sure we had the technology to pull it off.

DO WE HAVE A GAME?

The next question was how do you make the topic fun and interesting?

World War I produced the first air heroes, the Aces. We knew from the outset that they had to play a role. It seems there was a real personal competition going on among those guys, and the game had to evoke that feeling.

The idea of the “Ace Hunt” was the original spark that made us confident we had a game. We wanted to make a flight simulator that was more than just a string of non-connected flights, one that gave the player a reason for wanting to get back into the cockpit and go up. The concept of competing with deadly opponents seemed to provide that impetus. Further, making a sort of puzzle out of the whole thing – “where is that guy based, how will I know him when I see him, and how do I stop him from scoring...” – added another dimension that would greatly enhance the fun of the flying game, and provide a “personal” feel to the competition.

Also, the war itself provided some interesting situations. An arms race of sorts developed among the aircraft producers; everybody was trying desperately to build a better aeroplane – one that would make what the other guy had obsolete. In those days it was possible because aviation was in its infancy and there was a lot to be discovered. So, it was clear from the start that there had to be lots of different planes.

In addition, we wanted the player of our game to come away with a better understanding of World War I itself. It seems that most people have a cursory familiarity with the events of the war, and names like Richthofen and Ball, Voss and Nungesser, the Somme and Cambrai, ring a tiny little bell somewhere in the backs of our minds, but we don’t really know where to place them. Well, we hoped that by playing this game, the tiny little bell would ring louder.

Knights of the Sky provides a historical backdrop that satisfies all these needs. When you play the historical game, “World War I,” there’s a giant historical clock that ticks along triggering historical events: the appearance of a new fighter, a newspaper article about a major battle, or the entry – or death – of a powerful Ace. Also, the ground war causes enemy Aces to concentrate where the action is fiercest, and new depots, aerodromes, and HQs appear and disappear as time goes along.

Our philosophy, though, as always, is “fun over fact.” If history impedes the fun or flow of the game, well, we bend it. We base a lot of the “historical” event stuff on a random system that tends to *reflect* what really happened, but it ensures that it will never happen the same way in successive games – that would be too predictable, less fun. We give the player the “cool” equipment, the successful fighters – not the ones that didn’t work, or whose wings consistently fell off; that would be frustrating. We don’t require the player to fly *every day* of the war on dull, routine missions where there’s no opportunity to dogfight – that’d be boring. Instead, in his career, the player experiences only those missions in which something happened; think of your career as the highlights of a typical pilot’s life.

To an extent, game design is problem solving – creative problem solving – and compromise. One of the first issues that had to be dealt with was the planes themselves – there were an awful lot of them and, as in any computer game, there is a limited amount of space. It soon became evident that many of the neat-looking planes of the period would be extremely difficult to render and would have to be excluded. Many of these were not armed planes, and to include them would create a whole host of additional problems. I decided that only fighters would be available to the player to fly, and I defined fighter as any single-seat plane with a forward-firing machine gun.

The planes of the era did not fly like jets, so we had to have a whole new set of flight equations and algorithms. Scott Spanburg studied the physics of flight from the standpoint of biplanes and came up with very realistic flight. We then toned down some of the difficulties to make it easier for players to manage, but kept the essentials. In addition, you can fly 20 different fighters in *Knights of the Sky*, and each one flies a little differently; again, a momentous task.

There was also the issue of cockpits – every plane had a slightly different interior. In the tradition of good game design, we compromised. Certain essential items would be needed in every cockpit of the day, and certain items were essential for game-play. We made a generic cockpit based upon the Sopwith Camel's and decided that all the planes would use it; to you purists out there we apologize, but memory and storage are expensive.

The issue of navigation in the first air war was also interesting. In the absence of radar and other electronics, the pilots of the day had to rely upon ground features to guide them. Roads and rivers were the primary landmarks, and we had to have a 3D system that would produce roads and rivers that lead from place to place. What we came up with is a tiling system that includes over 40 different tiles. The entire world that you see as you fly is comprised of these tiles (think of tiles as patches in a patch-work quilt). The tiles were designed to be pieced together to form any road network. The trick was to get each tile to use as few points as possible, so the program would not spend an inordinate amount of time processing and drawing the world. We were pleased to discover that Napoleon built many of the roads in modern-day France and Belgium, and that he stipulated that they be as straight as possible to facilitate quick movement of armies.

One of the more interesting and challenging problems involved the aces. I wanted them to appear approximately when they did historically and disappear accordingly. They also needed to score in about the same numbers as they did historically, but at the same time respond to the player's ability. Therefore, the aces in the game score about what they did historically but never the same way in different games. Their scoring responds to lots of factors too numerous to discuss fully, but the planes they fly, the period of the war, and what planes the allies have contribute.

This leads to another point that I'm sure some people will wonder about. Why can't you be a German pilot? The enemy aces each have their own style of combat that corresponds, to a degree, to the tactics that each of the individuals favored. To include a full set of Allied aces would have been memory- and storage-space consuming and the tactics of the aces would inevitably blur together. Additionally, we would have had to double the amount of art in the game or make the same amount of art more generic and therefore less interesting.

Of course, in the training games, you can fly any plane you want – Allied or German; you can even pit an *eindekker* against an SE 5 or Camel, a situation that probably never occurred.

Data on planes was not difficult to get my hands on; the problem was deciding what to believe. Sources for technical data often contradicted each other and in those cases, I simply looked at averages and came up with what I felt was probably most accurate. It was very difficult to find good, up-to-date information on air operations during WWI. I finally came across a couple of excellent periodicals (*Cross and Cockade* and *Over the Front*) which I highly recommend to anyone interested in more info. But World War I is not the hottest topic around these days. Finding pictures of cockpits was particularly trying.

A case in point is location of important aerodromes. There were literally hundreds of airfields used and often for very brief periods. It was so difficult to determine the positions of individual units at any given time that the game, again, had to compromise. The eight permanent aerodromes on either side of the lines represent important centers of air activity, not actual aerodromes that existed throughout the war.

All in all, we wanted to create an excellent flight simulator that would give the feeling of flying old aeroplanes, and at the same time, provide a historical world that would allow the player to experience what it was like to be a flyer in the early days of aviation – a world packed with images of the past. If we accomplished this, then our work was good.

DO WE HAVE A TEAM!

Many people contributed to this project – even some, I’ll bet, that aren’t mentioned in the credits (to those people I apologize for my forgetfulness).

Scott Spanburg, the lead programmer, was able to accomplish some incredible feats. I said early on that roads and rivers in the game had to go somewhere because the player would have to navigate by following them. As far as I know, that’s not been done before, but Scott came up with a way of doing it, and it works. We wanted the dogfighting to be interesting and personal; there had to be great variety in quality of German pilots and aces. Scott did that. There are probably more polygons and points being pushed around on the screen of this game than in any PC game to date, and it works smooth and fast, thanks to Scott. We spent a great deal of time getting the 3D segment of the game to look as beautiful as it does, and most of it is attributable to Scott... and artist Jackie Ross.

Jackie is responsible for all the neat art. We thought the game should look like a slice of the past – a tough task for a *computer* game. So we wanted the art to smack of the period. Jackie, in her wisdom, decided that the poster art of the day was perfect for the computer screen and would certainly evoke the “slice-of-the-past” feeling we wanted. Most of the art you see harkens back, stylistically, to recruiting and propaganda posters that were rampant from 1914 to 1920. Jackie also created the 3D objects in the game – all the planes, buildings, trucks, artillery, balloons, explosions, and so on. She created all the cockpit interiors you see when you fly one of the planes and a host

of other details (and when the art tasks occasionally seemed to be too much, Art Director Michael Haire stepped in and helped out). The little animations that grace the Information screens are attributable to Jackie... along with programmer Bill Becker.

Bill wrote the software tool that allowed Jackie to make her art animate on your screen, but more significant to this game was Bill's work on the roleplaying and mission logic. He made the cool Briefing Screen that assigns your missions and decides where the enemy targets are. He also made the aces seem to have a life of their own, as they shoot down your comrades and, in general, do news-making stuff. All the overall logic that surrounds the flight game is Bill's work.

Ken Lagace wrote the "rags" that you hear during the game (they sound really nice if you have a good sound card in your computer - so go out and get one). Ken is the head of the sound department which includes Jim McConkey who does some amazing things with sound effects (if you have an MT-32 or AdLib synthesizer card you know what I mean).

That leaves me. I did what all designers at MicroProse do: researched and scoped out the concept of the game, wrote it up in the form of little algorithms, charts, and tables, wrote the screen text, and finally attempted to document the game, in this manual. Game designers at MicroProse also serve as administrative heads of design teams - they bother people and get ignored a lot.

The Quality Assurance crowd, led by Al Roireau, deserve a coke and a smile for their consistent heroic efforts at debugging and improving what has been done. Iris Idokogi and her gang of desktop publishing and computer-graphics thugs; Matt Scibilia, Susan Ullrich, and Michael Reis, deserve a lot of credit, especially this year for their overtime and perseverance. They put up with a lot and always right at the end of a long project.

We hope you enjoy what we've done here. Even if you don't, we want to know about it. Write to our Hunt Valley address.

Jeffery L. Briggs

August, 1990

MICROPROSE

Simulation Software

100 Industrial Estate, Tisbury, Wiltshire, G13

01264 81222 Fax (0665) 504331 Telex 44122 MP UK G

COPYRIGHT NOTICE

Copyright © 1990 by MicroProse Software, Inc., all rights reserved.

This manual and the computer programs and audiovisuals on the accompanying floppy disks, which are described by this manual, are copyrighted and contain proprietary information belonging to MicroProse Software Inc. No one may give or sell copies of this manual or the accompanying disks or of listings of the programs on the disks to any person or institution, except as provided for by written agreement with MicroProse Software, Inc. No one may copy, photocopy, reproduce, translate this manual or reduce it to machine readable form, in whole or in part, without the prior written consent of MicroProse Software, Inc. Any person/persons reproducing any portion of this program, in any media, for any reason, shall be guilty of Copyright Violation, and shall be subject to civil liability at the discretion of the copyright holder.

LIMITED WARRANTY

Neither MICROPROSE SOFTWARE, INC., nor any dealer or distributor makes any warranty, express or implied, with respect to this manual, the disk or any related item, their quality, performance, merchantability, or fitness for any purpose. It is the responsibility solely of the purchaser to determine the suitability of the products for any purpose. Some states do not allow limitations on implied warranties or how long an implied warranty lasts, so the above limitation may not apply to you.

As a condition precedent to the warranty coverage provided below and to ensure identification, the original purchaser must complete and mail to MicroProse Software, Inc., Unit 1, Hampton Road Industrial Estate, Tetbury, Gloucestershire GL8 8LD, within 30 days after purchase, the Registration/Warranty card enclosed in this product. To the original purchaser only, MicroProse Software, Inc. warrants the media to be free from defects in material for 90 days. If during the first 90 days after purchase a defect in media should occur, the software may be returned to MicroProse Software, Inc., who will replace the media at no charge. If at any time after the initial 90 day period your media becomes defective, the media may be returned to MicroProse Software for replacement at a reasonable service charge.

In no case will MicroProse Software, Inc. be held liable for direct, indirect or incidental damages resulting from any defect or omission in the manual, or other related items and processes, including, but not limited to, any interruption of service, loss of business, anticipated profit, or other consequential damages. Some states do not allow the exclusion or limitation of incidental or consequential damages, so the above limitation or exclusion may not apply to you.

This warranty gives you specific legal rights, and you may also have other rights which vary from state to state.

IMPORTANT: The above warranty does not apply if you make any unauthorized attempt to modify or duplicate the product, or if the product has been damaged by accident or abuse.

MICROPROSE

Simulation · Software

Unit 1, Hampton Road Industrial Estate, Tetbury, Gloucestershire GL8 8LD

Tel: (0666) 504326 Fax: (0666) 504331 Tlx: 43422 MPS UK G

**KIXX, Units 2 & 3, Holford Way, Holford, Birmingham B6 7AX
Telephone 021-625-3311**