

XBOX

LIVE

ONLINE ENABLED



Toca

RACE DRIVER 2™

ULTIMATE RACING SIMULATOR



Codemasters® 

GENIUS AT PLAY™

Safety Information

About Photosensitive Seizures

A very small percentage of people may experience a seizure when exposed to certain visual images, including flashing lights or patterns that may appear in video games. Even people who have no history of seizures or epilepsy may have an undiagnosed condition that can cause these "photosensitive epileptic seizures" while watching video games.

These seizures may have a variety of symptoms, including lightheadedness, altered vision, eye or face twitching, jerking or shaking of arms or legs, disorientation, confusion, or momentary loss of awareness. Seizures may also cause loss of consciousness or convulsions that can lead to injury from falling down or striking nearby objects.

Immediately stop playing and consult a doctor if you experience any of these symptoms. Parents should watch for or ask their children about the above symptoms – children and teenagers are more likely than adults to experience these seizures.

The risk of photosensitive epileptic seizures may be reduced by sitting farther from the television screen, using a smaller television screen, playing in a well-lit room, and not playing when you are drowsy or fatigued.

If you or any of your relatives have a history of seizures or epilepsy, consult a doctor before playing.

Other Important Health and Safety Information

The Xbox Instruction Manual contains important health and safety information that you should read and understand before using this software.

Avoid Damage to Your Television

Do not use with certain televisions. Some televisions, especially front- or rear-projection types, can be damaged if any video games, including Xbox games, are played on them. Static images presented during the normal course of game play may "burn in" to the screen, causing a permanent shadow of the static image to appear at all times, even when video games are not being played. Similar damage may occur from static images created when placing a video game on hold or pause. Consult your television owner's manual to determine if video games can be played safely on your set. If you are unable to find this information in the owner's manual, contact your television dealer or the manufacturer to determine if video games can be played safely on your set.

Unauthorized copying, reverse engineering, transmission, public performance, rental, pay for play, or circumvention of copy protection is strictly prohibited.

▶ Contents

Using the Xbox Video Game System

2

Using the Xbox Controller

3

Connect to Xbox Live

4

Controls

6

Getting Started

7

Your Racing Career

7

The Game Screen

8

The Trailer

10

Vehicle Setup

14

Thanks To

16

Special Thanks To

16

Credits

17

License Agreement

20

Customer Service

21

▶ Using the Xbox Video Game System

1. Set up your Xbox® video game system by following the instructions in the Xbox Instruction Manual.
2. Press the power button and the status indicator light will light up.
3. Press the eject button and the disc tray will open.
4. Place the ToCA Race Driver™2 disc on the disc tray with the label facing up and close the disc tray.
5. Follow the on-screen instructions and refer to this manual for more information about playing ToCA Race Driver™2.

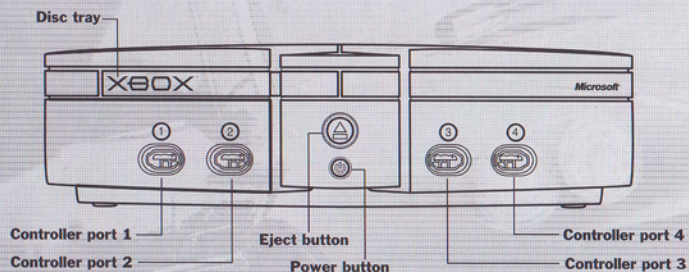

Avoiding Damage to Discs or the Disc Drive

To avoid damage to discs or the disc drive:

- Insert only Xbox-compatible discs into the disc drive.
- Never use oddly shaped discs, such as star-shaped or heart-shaped discs.
- Do not leave a disc in the Xbox console for extended periods when not in use.
- Do not move the Xbox console while the power is on and a disc is inserted.
- Do not apply labels, stickers, or other foreign objects to discs.

▶ Using the Xbox Controller

1. Insert the Xbox Controller into any controller port on the front of the Xbox console. For multiple players, insert additional controllers into available controller ports.
2. Insert any expansion devices (for example, Xbox Memory Units) into controller expansion slots as appropriate.
3. Follow the on-screen instructions and refer to this manual for more information about using the Xbox Controller to play ToCA Race Driver™2.

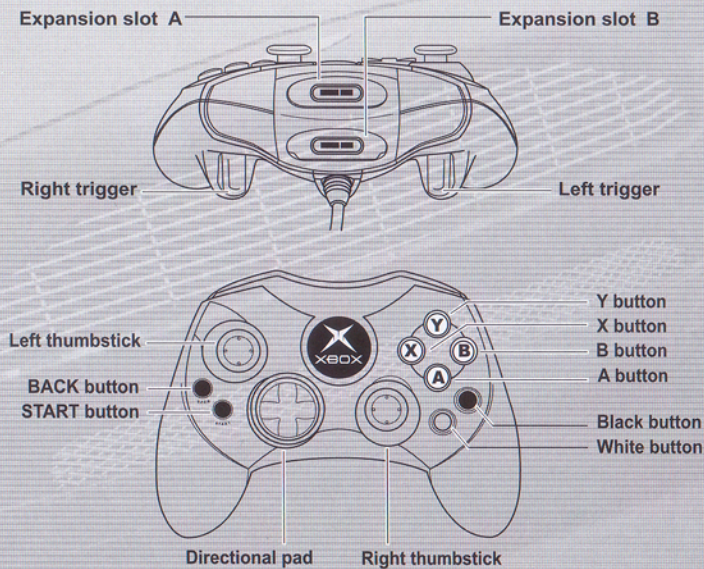

4 ▶ Connect to Xbox Live™

Take ToCA Race Driver™2 Beyond the Box

Xbox Live is a high-speed or broadband Internet gaming community where you can create a permanent gamer identity, setup a Friends List with other players, see when they're online, invite them to play and talk to them in real-time as you play.

Connecting

Before you can use Xbox Live, you need to connect your Xbox console to a high-speed or broadband Internet connection and sign up for the Xbox Live service. To determine if Xbox Live is available in your region and for information about connecting to Xbox Live, see www.xbox.com/connect.

Important! Before using this product, read the Xbox Manual for important safety information and health warnings.

Step 1: Connect

To connect your Xbox console directly to broadband, see diagram A. Or, to share your broadband connection with a PC, see diagram B.

For more details and other home networking options, including Internet connection sharing, see www.xbox.com/live.

A. Direct Connection

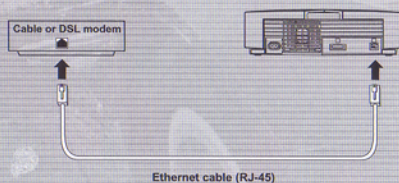

B. Shared Connection

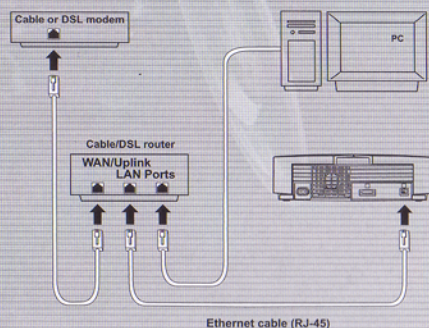

Step 2: Go Live

Important! Xbox Live™ is a subscription service. You will need a subscription code to set up an Xbox Live account and play online. To find out how to get a subscription code, visit your local retailer or see www.xbox.com/live.

You'll need to set up an Xbox Live account to play games online. Here's how:

1. Insert an Xbox Live Starter Kit disc or game disc into the disc tray. Check game packaging to see if the game supports Xbox Live play.
2. From within the game, select the option for Xbox Live.

At this point, the Xbox console will try to go online. If it works, create your Xbox Live account by following the instructions on screen and entering your subscription code when prompted.

If the Xbox console can't go online automatically, you'll get an error message. Go to Step 3.

Step 3: Configure (if necessary)

If you can't go online automatically, use Network Setup in the Xbox dashboard to enter some network settings. You may need to enter information such as a host name, a MAC address, or an ISP user name and password. Contact your broadband service provider if you don't have this information. Once you have the information, enter it in the Xbox Dashboard.

Need more help?

Should you have any problems connecting to the Xbox Live service, do not attempt to take apart, service, or modify the Xbox console or peripherals in any way. Doing so could present the risk of serious injury or death from electric shock or fire and will also void your warranty. For additional assistance see www.xbox.com/live or call the Customer Support number:

United States and Canada:
1-800-4MY-XBOX
(1-800-469-9269)

TTY users (requires special equipment for hard of hearing):
1-866-740-9269 or 1-425-635-7102

Car Controls

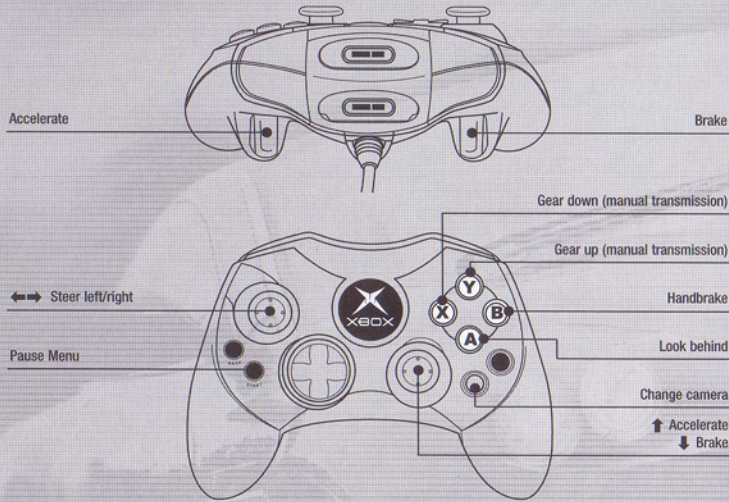

Menu Navigation

- Highlight menu item: directional pad or left thumbstick **↑ ↓**
- Change menu item option where available: directional pad or left thumbstick **← →**
- Select highlighted menu item: **A** or **START**
- Cancel/exit menu: **B** or **BACK**

Player Profile

When the game has loaded, either select a player profile or create a new one. You will need to create a new profile if you are loading the game for the first time.

Creating a New Profile

First select a save slot to store your new profile in. As you continue through your driving career, all of your progress and feature unlocks will be saved to this profile.

Next set up your profile details and select "Done." Finally, complete your profile by defining game options (see Options for more information) and when you have finished, select "Begin" to start your career.

Your Racing Career

The gauntlet has been thrown down. Become the master of the racing world or vanish into obscurity forever!

The career of a professional racing driver is not an easy one; you'll contend not only with a multitude of racing styles and types of vehicles, but also with a host of deadly rivals out to claim the title for themselves.

It's all about winning — there's no room for mediocrity here. You'll have to fulfill all your team's objectives to earn your placement in the next event.

With each successful step through your career, you'll unlock more tracks, vehicles and competitions in Simulator mode.

▶ The Game Screen

Circuit Racing

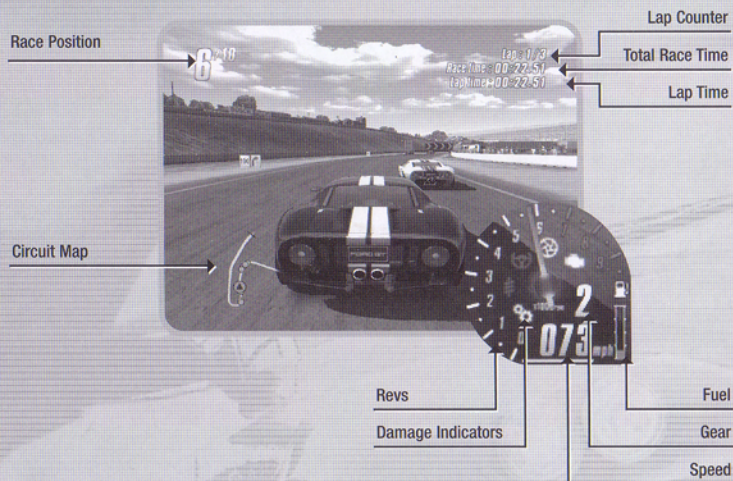





Rally



- Race Position** Your position in the field of competitors.
- Circuit Map** The position of your car and your nearest rivals on the current circuit (your car is indicated by the arrow).
- Lap Counter** Laps completed so far.
- Total Race Time** The time elapsed so far through your current race.
- Lap Time** The time elapsed so far on your current lap.
- Revs** Your current engine speed (rpm).
- Damage Indicators** Illuminate from yellow (minimal) to red (serious) as parts of your vehicle become damaged. If a part becomes so damaged that you cannot finish in a competitive position, you may want to retire. To retire, press **START** to pause the game and select "End Race," then "Retire from Race."

Note: If you sustain terminal damage and parts can no longer function at all, you will automatically be retired from the race.

-  **Gears:** damage to your gearbox could impair your ability to reach top speeds or shift effectively from gear to gear.
-  **Suspension:** suspension damage will affect road-holding and cornering abilities.
-  **Steering:** as your steering becomes damaged you will be less able to hold a straight line and your vehicle's responsiveness will be reduced.
-  **Wheels:** a puncture or loss of a wheel could prevent you from finishing the race.
-  **Engine:** if your engine becomes damaged, your performance can be seriously reduced.

- Fuel** The amount of fuel remaining in your tank.
- Gear** The gear you are currently in.
- Speed** Your current speed.
- Stage Progress** Shows your progress through the stage in rally championships.
- Split Time** Split times represent the fastest recorded time through each section of a rally stage. As you approach a split time marker on a rally stage, your split time will appear next to the stage progress bar. If your time is green, you are currently faster than the previous record for the stage; if the time shown is red, you are slower.

Co-driver Indicator Indicates the direction and hazardousness of the road ahead.

Select Profile

Return to the Profile Selection screen to load, create or delete a profile.

Continue Career

Pick up your racing career from where you left off (depending on the profile you've loaded) and select which championship to compete in if more than one is available. Keep racing and keep winning to meet the Championship Objective/s and Season Objective/s set by your team.

Simulator

Come to the Simulator when you want to create your own race (Free Race) or improve your best time (Time Trial) on any of the unlocked tracks. Whenever you achieve a team objective in your racing career, more tracks, vehicles and championships will become unlocked.

Free Race

Select Difficulty

Highlight "Normal" or "Hard" depending on the difficulty level you want to race and press **A**, then select the Championship you want to race from those unlocked and press **A** again.

To set a custom difficulty level, highlight "Custom" then press the left thumbstick or directional pad **←→**. Press **A** when you're ready to proceed.

Next, set up your Championship. The first circuit is already selected (though you can change this if you want to). To add more tracks, highlight an empty slot, then press the left thumbstick or directional pad **←→** to highlight an additional track. Press **A** to load the track into the Championship line-up. Alternatively, choose "Select All" to load all of the tracks in their original order.

When you're ready, select "Continue" to move on.

Series Options

Highlight each of the options shown on screen and press the left thumbstick or directional pad **←→** to adjust them. Select "Continue" to move on.

Vehicle Select

Highlight "Model" and press the left thumbstick or directional pad **←→** to choose the vehicle you want to take onto the track. Only vehicles relevant to the Series you've selected will be available.

Highlight "Team" and press the left thumbstick or directional pad **←→** to select your team (and thus your vehicle's livery).

Next, highlight "Driver" and press the left thumbstick or directional pad **←→** to choose your driver. Only those drivers relevant to the team you've selected will be available.

Finally, press **A** to hit the track.

Time Trial

Use Time Trial to improve your performance on circuits from any of the unlocked Championships.

Choose the model, team and driver you want to take to the track and press **A** to set up your vehicle (see Vehicle Setup — only those setup options relevant to the vehicle you've chosen will be available).

Multiplayer

Shake it down on the track with two players in split-screen Multiplayer mode.

Each player presses **START** to join the game, then Player 1 selects the difficulty level, Championship, circuit/s and Championship options as for Free Race (some options are unavailable in multiplayer mode).

Finally, each player in turn selects their vehicle, team and driver. Only those unlocked vehicles relevant to the chosen Championship will be available. When Player 2 has selected their vehicle, the competition will commence.

System Link

Select "System Link" to start or join a multiplayer game using linked Xbox systems.

Join

Enter the game lobby of one of the games created on other linked Xbox video game systems in the session list shown on screen.

Choose your vehicle, team and driver and when you are ready, select "Ready." The race will begin 15 seconds after the Host (the creator of the game) selects "Ready," so make sure you're in time.

Create

Use the options shown on the Session Settings screen to define the parameters for your session and the series to be raced. When you are finished, select "Start Session." Your game will appear on the session list of any linked Xbox video games systems for other players to join as above. Next, choose your car, edit your tracks and set up your game following the options shown on screen.

When you are ready to hit the track, select "Ready." After 15 seconds the race will begin and all ready players will join you on the track.

Network Options

Use "Network Options" to redefine your player name and de/activate or define voice output.

Xbox Live

Select "Xbox Live" to take part in a multiplayer game on Xbox Live. You must previously have created an Xbox Live account and gamertag. Refer to the instructions supplied with Xbox Live for information on how to do this.

Use "Select Account" to choose a gamertag and proceed, or "New Account" to return to the Xbox Live Dashboard and create a new account.

Quick Match Quick Match is the quickest and easiest way to get into a game; it selects the first game running that you are able to join. Either select "Join" to enter the game displayed, or "Refresh" to bring up the next choice.

OptiMatch OptiMatch allows you to specify exactly what sort of game you're looking for. Use the navigation controls to define the criteria for your game search (i.e. championship, collision mode, etc), then select "Search" to display a list of games running that match your preferences. Select "Join" then highlight a game in the list displayed and press **A** to go to the Lobby for that game.

Create Session Select "Create Session" then follow the options on screen to set up your own game for others to join. If you want to enable anyone to join, make your game "Public" under "Session Type," however if you only want people from your Friends list to be able to drive with you, make it a "Private" game and invite players to join.

Note: an on-screen notification will be displayed if the speed of your connection could adversely affect gameplay.

The Lobby At the beginning of any Xbox Live race, you will enter the game Lobby to prepare.

Choose your team and/or car then go to Vehicle Setup (if enabled by your Host) to refine your vehicle's performance (see Vehicle Setup). When you're satisfied with your vehicle's tuning, select "Continue" to return to the Lobby.

Finally to get onto the track, select "Ready" to indicate to the host that you have completed all your setups and are raring to go. 15 seconds after the Host has indicated "Ready," the race will begin (regardless of whether all joining players are ready or not).

Note: If you join a game where players are already racing, "Race in Progress" will be displayed on screen. You must wait for the current race to finish before entering the main Lobby.

Options

Profile

Select "Profile" to give yourself a name to be used in your career and other game modes, and choose your game language and nationality. When you are satisfied, select "Done" to return to the Options.

Driving

Select "Driving" to define your driving style and controller preferences.

Control Assignments: To re-define a control, highlight the function name and press **A**, then press the control you want to assign to that function. To restore all the original control settings, select "Reset To Default."

Vibration: Turn controller vibration on or off.

Advanced: Adjust deadzone and saturation settings for steering wheel controllers. This option is only available when a steering wheel controller is connected.

Gearbox: Select "Automatic" and gears will change automatically as needed — a good option for novice drivers.

Select "Manual" to bring the Gear Up/Gear Down controls into play. This will give experienced drivers more control.

Select "Manual with Clutch" for a totally realistic driving experience for elite drivers.

Graphics

Select "Graphics" to turn on-screen display elements on or off.

Note: split-screen settings are defined through the Xbox Dashboard.

Sound

Select "Sound" to set the volume of the game's sound elements.

Bonus

Select "Bonus" to view the credits of the team that brought you this game and activate extra bonuses. Check out the back cover of this manual for how to obtain Bonus Codes.

▶ Vehicle Setup

In Time Trial, Free Race and Xbox Live/System Link games (if enabled by the host), you get to tune your vehicle to adjust its performance. Though many drivers take the podium with just factory specs, most drivers like to tweak their settings between races to wring that extra speed out of their vehicle. With a little experience, you'll know what specs suit your cars best.

Note: Vehicle Setup is not available in all Championships and not all setup options will be available to all vehicles.

Gears

To adjust gears, select "Gears." Next, select "Adjust" then press the left thumbstick or directional pad $\uparrow\downarrow$ to choose the gear to be adjusted. With the gear highlighted, press the left thumbstick or directional pad $\leftarrow\rightarrow$ to adjust its parameters. To restore your gear ratios to their factory settings, select "Default." When you're done, press **A** then select "Accept."

Gears with a high ratio will give you an improved top speed, but you will take a hit to your acceleration in the lower gears. Conversely, a low ratio makes your vehicle quick off the mark but also impairs your ability to achieve really high speeds.

Downforce

To adjust downforce, select "Downforce." Next, select "Adjust" and press the left thumbstick or directional pad $\leftarrow\rightarrow$ to select front or rear downforce and $\uparrow\downarrow$ to adjust the setting of each. When you have finished, press **A** and then select "Accept."

Your spoilers use the pressure differential of moving air to force your wheels down onto the road and improve grip. Too much downforce though will increase your rolling resistance and decrease your straight-line speed.

Suspension

To adjust your suspension, select "Suspension." Next, select "Adjust" and press the left thumbstick or directional pad $\leftarrow\rightarrow$ to select front or rear suspension and $\uparrow\downarrow$ to adjust the stiffness of each. When you have finished, press **A** and then select "Accept."

Suspension affects your vehicle's road holding and ability to handle corners at speed. Soft suspension will cope more easily with uneven surfaces as each wheel is allowed to responsively maintain contact with the ground. However, suspension that is too soft may cause excessive body-roll on bends. Hard suspension, on the other hand, improves your corner-taking ability but on rough terrain, you may find grip is markedly reduced.

Ride Height

To change your vehicle's ride height, select "Ride Height." Next, select "Adjust" and press the left thumbstick or directional pad $\uparrow\downarrow$ to change the setting. When you have finished, press **A** and then select "Accept."

Adjusting the ride height changes the range that your suspension can work within. A high ride height gives the greatest range for your shock, but also the greatest potential for body roll and at a cost to downforce and grip.

Anti-Roll

To adjust anti-roll, select "Anti-Roll." Next, select "Adjust" and press the left thumbstick or directional pad $\leftarrow\rightarrow$ to select front or rear then $\uparrow\downarrow$ to adjust the setting for each. When you have finished, press **A** and then select "Accept."

Anti-roll is used to balance your suspension settings and counter understeering or oversteering problems. If your vehicle understeers too much (tends not to pull into bends as quickly as it should) soften the front or stiffen the rear. If it oversteers (tends to swing out when taking a corner), soften the rear or stiffen the front.

Tires

To adjust your tires, select "Tires." Next, select "Adjust" and press the left thumbstick or directional pad $\leftarrow\rightarrow$ to move the slider left or right between hard and soft. When you have finished, select "Accept" to return to the Vehicle Setup screen.

Hard tires will give you less grip but will reduce any rolling resistance and allow a greater top speed. Tires made from a softer compound will improve your grip, but will increase rolling resistance.

Brake Bias

To adjust your brake bias, select "Brake Bias." Next, select "Adjust" and press the left thumbstick or directional pad $\leftarrow\rightarrow$ to move the slider left or right between front and rear. When you have finished, select "Accept."

In addition to your suspension and anti-roll, brake bias will also affect the way your vehicle handles in the bends. When you decelerate, the weight of your car is forced forwards onto the front wheels. This will increase frontal grip but will make the back of your vehicle light. This can help steering into tight corners as it will help the back shift round, but combined with too much speed can easily send you into an uncontrollable spin.

Be careful when placing too much bias on the front wheels. Too much can lock your brakes more easily and when your brakes are locked, it's impossible to steer.

Load

Select a previously saved setup to install on your current vehicle.

Save

Save your current setup for future use.

Delete

Delete a saved setup.

Test Drive

Take your newly tuned vehicle out onto the track and see how it feels.

16

► Thanks To

Aston Martin Lagonda, AC Car Group Limited, Barry Pomfret, Ford Motor Company, Graham Hathaway Engineering Ltd., Jaguar Cars Limited, Koenig Specials, Land Rover Group Ltd, Mitsubishi Motors Corporation, Nissan Motor Company Limited, SEAT S.A., SEAT SPORT S.A., The Beanstalk Group, Fuji Heavy Industries Limited, Bowler Off Road Ltd, AA Racing (Pty) Ltd, Donington Park, Ring Management, Rennstrecken Betriebs-GmbH, International Management Group of America Pty Limited, Brands Hatch Leisure Group, Mazda Raceway Laguna Seca, Oulton Park, Pikes Peak International Raceway, Road America, Motor Events Sweden AB, Nürburgring GmbH, Rockingham Motor Speedway, Autodromo Di Vallelunga, Texas Motorspeedway, Brembo S.p.A, Superchips Inc, OMP Racing, EPTG Limited, Koni BV, Federal Mogul, Collins Performance Engineering, Hella, Sparco S.p.A, K & N Engineering, Inc, DPRS, MOOG, Champion, Nudge Mobile, Bridgestone, Compomotive, Ferodo, Micro Dynamics/Lumenition, Mongoose, Powerflex, Pipercross, Powerchip SPA, Pace.

► Special Thanks To

Frauke Meyer, Jörg Pfahl, WM GmbH, The Board Members of the ITR e.V, The DTM Championship and all of the teams, drivers, car manufacturers, circuits and sponsors associated with the series, Tracey Benton, Bianca Bruzzano, Basil Scaffidi, The Board Members of Australian Vee-Eight Supercar Company Pty Ltd (AVESCO), Australian V8 Supercar Championship and all of the teams, drivers, car manufacturers, circuits and sponsors associated with the series.

► Credits

This product is manufactured and distributed under license from International Management Group of America Pty Limited.

MUSTANG and COBRA are registered trademarks owned and licensed by Ford Motor Company.

The word "Jaguar," the leaping cat device, and the characters E-TYPE SERIES II, XJ220 and XKR are the trademarks of Jaguar Cars Ltd., England and are used under license.

The words "Aston Martin," the wings device and the words DB7 VOLANTE, DB5, DB9 COUPE and V12 VANQUISH are the trademarks of Aston Martin Lagonda Limited, United Kingdom and are used under license.

Land Rover, DEFENDER BOWLER WILDCAT and the Land Rover Logo are trademarks owned and licensed by Land Rover. ©Land Rover.

Original Music Composed and Arranged by Nimrod Productions Limited.



Uses Bink Video.

Copyright © 1997-2004 by RAD Game Tools, Inc.

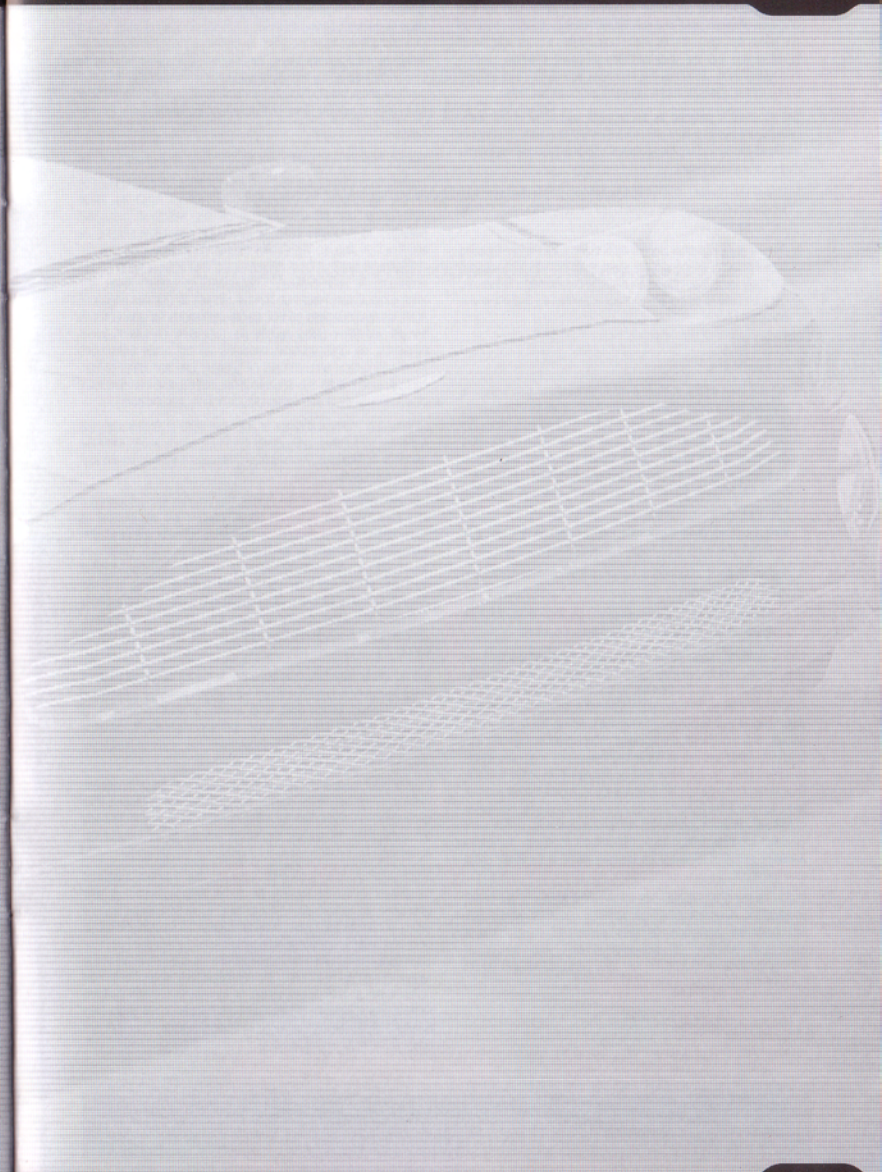
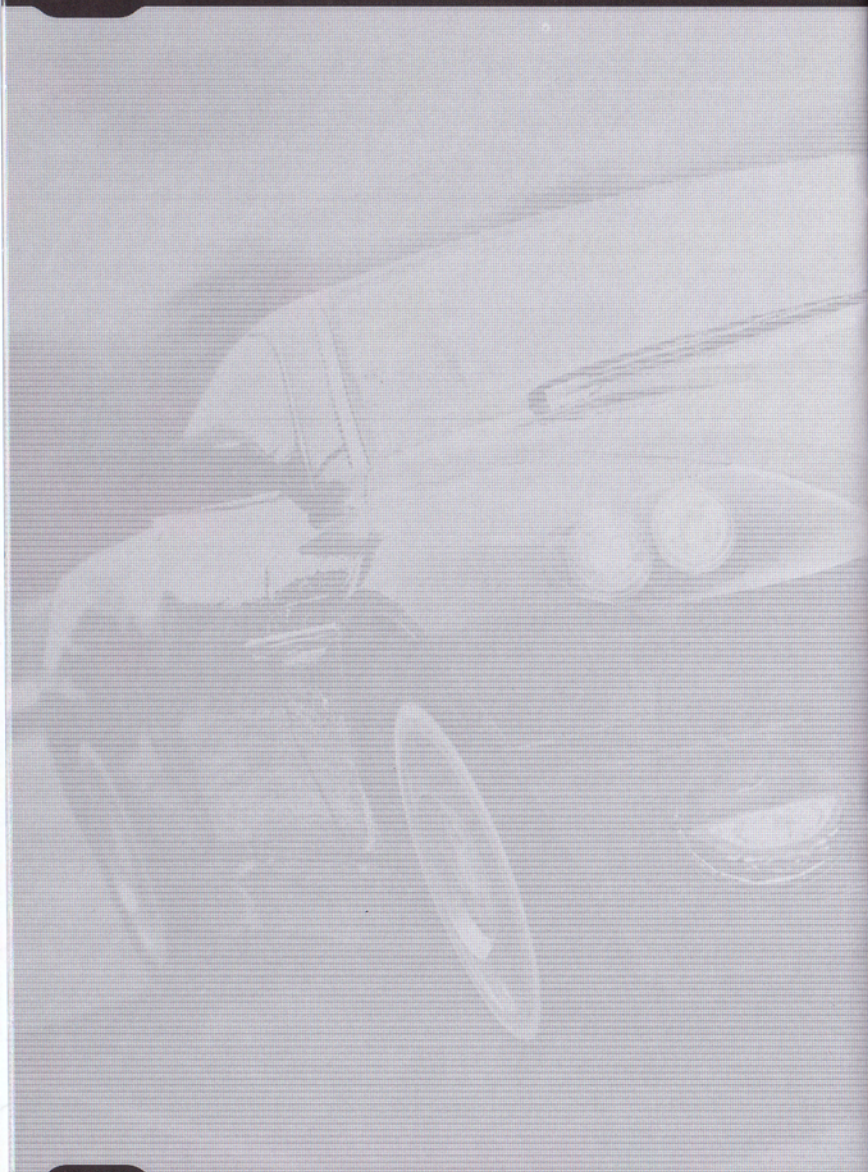

THE CODEMASTERS SOFTWARE COMPANY LIMITED SOFTWARE LICENSE AGREEMENT

IMPORTANT - READ CAREFULLY: THE ACCOMPANYING PROGRAM (WHICH INCLUDES COMPUTER SOFTWARE PROGRAM, THE MEDIA AND RELATED DOCUMENTATION IN PRINTED OR ELECTRONIC FORM) IS LICENSED TO YOU ON THE TERMS SET FORTH BELOW, WHICH CONSTITUTES A LEGAL AGREEMENT BETWEEN YOU AND THE CODEMASTERS SOFTWARE COMPANY LIMITED. ("CODEMASTERS"). BY USING THE PROGRAM, YOU AGREE TO BE LEGALLY BOUND BY THE TERMS OF THIS AGREEMENT WITH CODEMASTERS.

THE PROGRAM is protected by the copyright laws of the United States, international copyright treaties and conventions and other laws. The Program is licensed, and not sold, and this Agreement confers no title or ownership to the Program or any copy thereof.

1. Limited Use License. Codemasters grants you the non-exclusive, non-transferable, limited right and license to use one copy of the Program solely for your personal use.
2. Ownership. All intellectual property rights in and to the Program (including but not limited to video, audio and other content incorporated therein) and title to any and all copies thereof are owned by Codemasters or its licensors, and you receive no right or interest therein other than the limited license in paragraph 1 hereof.

YOU SHALL NOT:

- * Copy the Program.
- * Sell, rent, lease, license, distribute or otherwise transfer or make available to any other person the Program, in whole or in part, or use the Program or any part thereof in any commercial context, including but not limited to use in a service bureau, "cyber cafe", computer gaming center or any other commercial location in which multiple users may access the Program. Codemasters may offer a separate Site License Agreement to permit you to make the Program available for commercial use; see the contact information below.
- * Reverse engineer, derive source code, modify, decompile, disassemble, or create derivative works of the Program, in whole or in part.
- * Remove, disable or circumvent any proprietary notices or labels contained on or within the Program.
- * Export or re-export the Program or any copy or adaptation in violation of any applicable U.S. export restrictions or other laws or regulations.

LIMITED WARRANTY. Codemasters warrants to the original consumer purchaser of the Program that the recording medium on which the Program is recorded will be free from defects in material and workmanship for 90 days from the date of purchase. If the recording medium of a product is found defective within 90 days of original purchase, Codemasters agrees to replace, free of charge, such product within such period upon its receipt of the Product, postage paid, with proof of the date of purchase, as long as the Program is still being manufactured by Codemasters. In the event that the Program is no longer available, Codemasters retains the right to substitute a similar program of equal or greater value. This warranty is limited to the recording medium containing the Program as originally provided by Codemasters and is not applicable and shall be void if the defect has arisen through abuse, mistreatment, or neglect. Any implied warranties prescribed by statute are expressly limited to the 90-day period described above.

EXCEPT AS SET FORTH ABOVE, THIS WARRANTY IS IN LIEU OF ALL OTHER WARRANTIES, WHETHER ORAL OR WRITTEN, EXPRESS OR IMPLIED, INCLUDING ANY WARRANTY OF MERCHANTABILITY, FITNESS FOR A PARTICULAR PURPOSE OR NON-INFRINGEMENT, AND NO OTHER REPRESENTATIONS OR CLAIMS OF ANY KIND SHALL BE BINDING ON OR OBLIGATE CODEMASTERS.

When returning the Program for warranty replacement please send the original product disks only in protective packaging and include: (1) a photocopy of your dated sales receipt; (2) your name and return address typed or clearly printed; (3) a brief note describing the defect, the problem(s) you encountered and the system on which you are running the Program; (4) if you are returning the Program after the 90-day warranty period, but within one year after the date of purchase, please include check or money order for \$15 U.S. currency per CD or floppy disk replacement. Note: Certified mail recommended.

Send to:

Warranty Replacements, Codemasters Inc., P.O. Box 2150, Oakhurst, CA 93644

LIMITATION ON DAMAGES. IN NO EVENT WILL CODEMASTERS BE LIABLE FOR SPECIAL, INCIDENTAL OR CONSEQUENTIAL DAMAGES RESULTING FROM POSSESSION, USE OR MALFUNCTION OF THE PROGRAM, INCLUDING DAMAGES TO PROPERTY, LOSS OF GOODWILL, COMPUTER FAILURE OR MALFUNCTION AND, TO THE EXTENT PERMITTED BY LAW, DAMAGES FOR PERSONAL INJURIES, EVEN IF CODEMASTERS HAS BEEN ADVISED OF THE POSSIBILITY OF SUCH DAMAGES. CODEMASTERS LIABILITY SHALL NOT EXCEED THE ACTUAL PRICE PAID FOR THE LICENSE TO USE THIS PROGRAM. SOME STATES/COUNTRIES DO NOT ALLOW LIMITATIONS ON HOW LONG AN IMPLIED WARRANTY LASTS AND/OR THE EXCLUSION OR LIMITATION OF INCIDENTAL OR CONSEQUENTIAL DAMAGES, SO THE ABOVE LIMITATIONS AND/OR EXCLUSION OR LIMITATION OF LIABILITY MAY NOT APPLY TO YOU. THIS WARRANTY GIVES YOU SPECIFIC LEGAL RIGHTS, AND YOU MAY HAVE OTHER RIGHTS WHICH VARY FROM JURISDICTION TO JURISDICTION.

TERMINATION. Without prejudice to any other rights of Codemasters, this Agreement will terminate automatically if you fail to comply with its terms and conditions. In such event, you must destroy all copies of the Program and all of its component parts.

U.S. GOVERNMENT RESTRICTED RIGHTS. The Program and documentation have been developed entirely at private expense and are provided as "Commercial Computer Software" or "restricted computer software." Use, duplication or disclosure by the U.S. Government or a U.S. Government subcontractor is subject to the restrictions set forth in subparagraph (c)(1)(ii) of the Rights in Technical Data and Computer Software clauses in DFARS 252.227-7013 or as set forth in subparagraph (c)(1) and (2) of the Commercial Computer Software Restricted Rights clauses at FAR 52.227-19, as applicable. The Contractor/Manufacturer is Codemasters Inc., P.O. Box 2150, Oakhurst, CA 93644

INJUNCTION. Because Codemasters would be irreparably damaged if the terms of this Agreement were not specifically enforced, you agree that Codemasters shall be entitled, without bond, other security or proof of damages, to appropriate equitable remedies with respect to breaches of this Agreement, in addition to such other remedies as Codemasters may otherwise have under applicable laws.

INDEMNITY. You agree to indemnify, defend and hold Codemasters, its partners, affiliates, contractors, officers, directors, employees and agents harmless from all damages, losses and expenses arising directly or indirectly from your acts and omissions to act in using the Product pursuant to the terms of this Agreement.

MISCELLANEOUS. This Agreement represents the complete agreement concerning this license between the parties and supersedes all prior agreements and representations between them. It may be amended only by a writing executed by both parties. If any provision of this Agreement is held to be unenforceable for any reason, such provision shall be reformed only to the extent necessary to make it enforceable and the remaining provisions of this Agreement shall not be affected. This Agreement shall be construed under California law as such law is applied to agreements between California residents entered into and to be performed within California, except as governed by federal law and you consent to the exclusive jurisdiction of the state and federal courts in Los Angeles, California.

Technical Support

Codemasters Inc.
Tel (559) 683-4468

URL: <http://www.codemasters.com>

E-mail: support@codemastersusa.com

© 2004 The Codemasters Software Company Limited ("Codemasters"). All rights reserved. "Codemasters"® and the Codemasters logo are registered trademarks owned by Codemasters. "Race Driver"™, "Ultimate Racing Simulator"™ and "GENIUS AT PLAY"™ are trademarks of Codemasters. All other copyrights or trademarks are the property of their respective owners and are being used by Codemasters under license.

Microsoft, the Microsoft Game Studios logo, OptiMatch, Xbox, Xbox Live, the Xbox logo, the Xbox Live logo, the XSN Sports logo are either registered trademarks or trademarks of Microsoft Corporation in the United States and/or other countries, and are used under license from Microsoft. FOR HOME USE ONLY. Unauthorized copying, adaptation, rental, lending, distribution, extraction, re-sale, arcade use, charging for use, broadcast, public performance and internet, cable or any telecommunication transmission, access or use of this product or any trademark or copyright work that forms part of this product are prohibited.

If you have any questions concerning this license, you may contact Codemasters at:
The Codemasters Software Company Limited, PO Box 6, Leamington Spa Warwickshire CV47 2ZT United Kingdom. Tel +44 1926 814 132, Fax +44 1926 817 595.

TO RECEIVE THE LATEST...

TOCA

RACE DRIVER 2™

ULTIMATE RACING SIMULATOR

...game news, exclusive access to demos,
videos, downloads and much more...

REGISTER ONLINE NOW

at

www.codemasters.com/register



Codemasters® 

GENIUS AT PLAY™

© 2004 The Codemasters Software Company Limited ("Codemasters"). All rights reserved. "Codemasters" and the Codemasters logo are registered trademarks owned by Codemasters. "Race Driver"™ 2, "Ultimate Racing Simulator"™ and "GENIUS AT PLAY"™ are trademarks of Codemasters. All other copyrights or trademarks are the property of their respective owners and are being used by Codemasters under license. Microsoft, Xbox and the Xbox logos are either registered trademarks or trademarks of Microsoft Corporation in the U.S. and/or in other countries and are used under license from Microsoft.

400768

BONUS CODES

Can't wait to unlock all the extra features in ToCA Race Driver™2?

Unlocks available for all vehicles, all tracks, all championships, and much, much more...

log onto

www.codemasters.com/bonuscodes

or call

900-990-6640

CALLS COST \$1.99 PER MINUTE

Calls from cellphones vary. Callers must be over 16 and have permission from the bill payer. Prices correct at time of going to press.

BEFORE YOU CALL, READ THROUGH THESE STEP-BY-STEP DIRECTIONS...*

1. In your game, go to Options > Bonus > Unlocking Information and write down the Bonus Number. You need this to access the Bonus Codes.
2. Log on or call the Hintline on the number above and follow the directions to the ToCA Race Driver™2 area.
3. When requested, enter the Bonus Number you obtained in Step 1.
4. If you're buying the codes online (requires credit card), the full set will be emailed to you. If you are calling the Hintline, write down the codes as they are read to you; you can access as many or as few Bonus Codes in one call as you like.
5. To unlock the Bonuses, go to the Bonus screen, select "Enter Bonus Code" and enter the Code/s you've been given. Finally select "Activate Bonus" to turn the new feature on.

*Requires touch tone telephone and ToCA Race Driver™2 save file.

IMPORTANT: Bonus Numbers and Bonus Codes supplied are unique to your console, game and saves. Bonuses supplied can also be unlocked by playing the game through to completion.

