

BUST-A-MOVE 4™

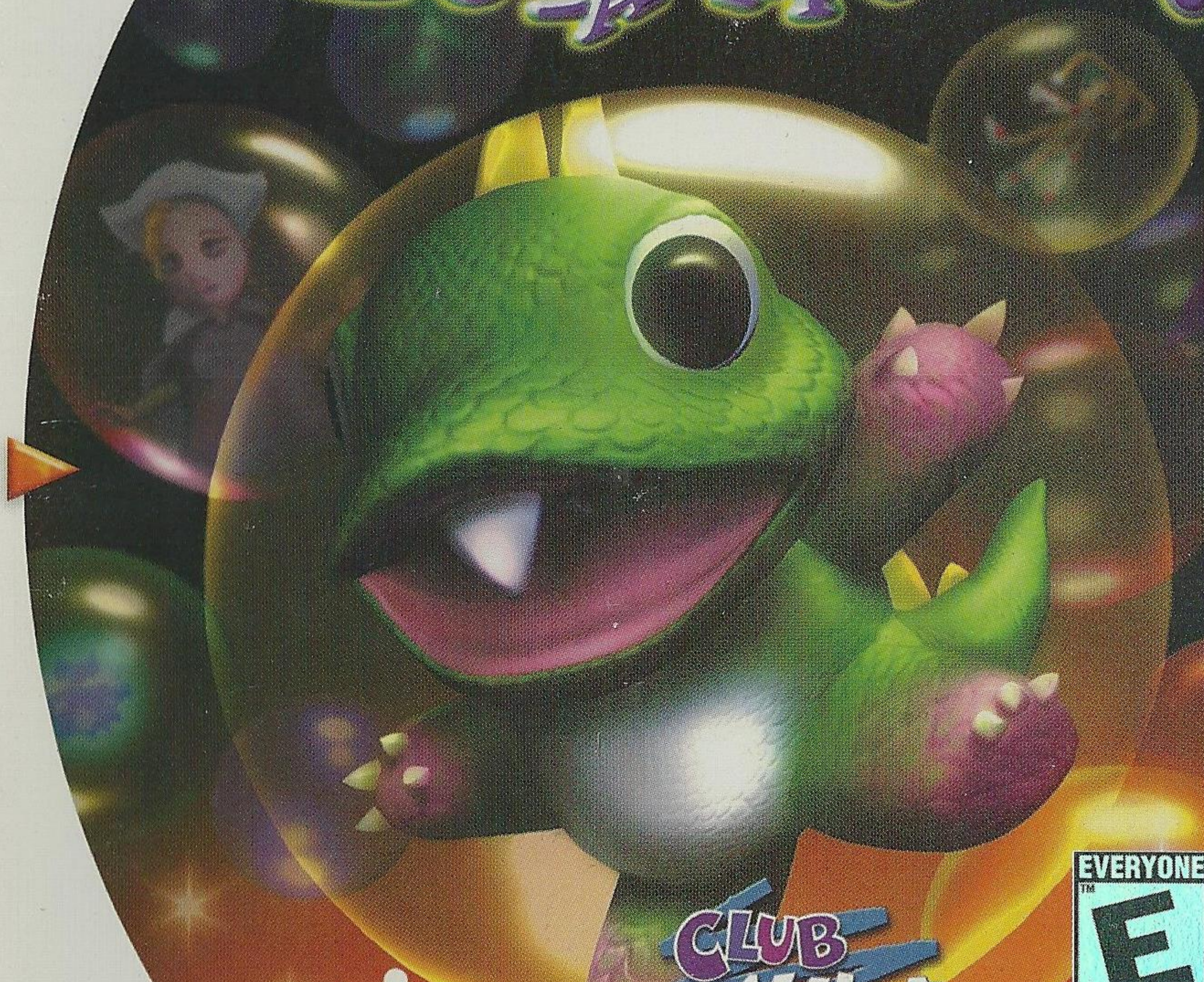

SEGA®

TAITO®

CLUB
AKKlaim

EVERYONE
TM
E
CONTENT RATED BY
ESRB

T-8117N

WARNINGS Read Before Using Your Sega Dreamcast Video Game System

CAUTION

Anyone who uses the Sega Dreamcast should read the operating manual for the software and console before operating them. A responsible adult should read these manuals together with any minors who will use the Sega Dreamcast before the minor uses it.

HEALTH AND EPILEPSY WARNING

Some small number of people are susceptible to epileptic seizures or loss of consciousness when exposed to certain flashing lights or light patterns that they encounter in everyday life, such as those in certain television images or video games. These seizures or loss of consciousness may occur even if the person has never had an epileptic seizure.

If you or anyone in your family has ever had symptoms related to epilepsy when exposed to flashing lights, consult your doctor prior to using Sega Dreamcast.

In all cases, parents should monitor the use of video games by their children. If any player experiences dizziness, blurred vision, eye or muscle twitches, loss of consciousness, disorientation, any involuntary movement or convulsion, **IMMEDIATELY DISCONTINUE USE AND CONSULT YOUR DOCTOR BEFORE RESUMING PLAY.**

To reduce the possibility of such symptoms, the operator must follow these safety precautions at all times when using Sega Dreamcast:

- Sit a minimum of 6.5 feet away from the television screen. This should be as far as the length of the controller cable.
- Do not play if you are tired or have not had much sleep.
- Make sure that the room in which you are playing has all the lights on and is well lit.
- Stop playing video games for at least ten to twenty minutes per hour. This will rest your eyes, neck, arms and fingers so that you can continue comfortably playing the game in the future.

OPERATING PRECAUTIONS

To prevent personal injury, property damage or malfunction:

- Before removing disc, be sure it has stopped spinning.
- The Sega Dreamcast GD-ROM disc is intended for use exclusively on the Sega Dreamcast video game system. Do not use this disc in anything other than a Sega Dreamcast console, especially not in a CD player.
- Do not allow fingerprints or dirt on either side of the disc.
- Avoid bending the disc. Do not touch, smudge or scratch its surface.
- Do not modify or enlarge the center hole of the disc or use a disc that is cracked, modified or repaired with adhesive tape.
- Do not write on or apply anything to either side of the disc.
- Store the disc in its original case and do not expose it to high temperature and humidity.
- Do not leave the disc in direct sunlight or near a radiator or other source of heat.
- Use lens cleaner and a soft dry cloth to clean disc, wiping gently from the center to the edge. Never use chemicals such as benzene and paint thinner to clean disc.

PROJECTION TELEVISION WARNING

Still pictures or images may cause permanent picture tube damage or mark the phosphor of the CRT. Avoid repeated or extended use of video games on large-screen projection televisions.

SEGA DREAMCAST VIDEO GAME USE

This GD-ROM can only be used with the Sega Dreamcast video game system. Do not attempt to play this GD-ROM on any other CD player; doing so may damage the headphones and/or speakers. This game is licensed for home play on the Sega Dreamcast video game system only. Unauthorized copying, reproduction, rental, public performance of this game is a violation of applicable laws. The characters and events portrayed in this game are purely fictional. Any similarity to other persons, living or dead, is purely coincidental.

TABLE OF CONTENTS

Starting Up.....	3
A Bedtime Story	4
Default Controls	5
Starting Out	7
The Screen	10
Basic Rules	11
Game Modes	12
Edit Mode.....	15
Special Bubbles	18
The Characters	19
Hints & Tips	21



STARTING UP

1. Insert your **BUST-A-MOVE 4™** Sega Dreamcast™ Specific Disc into your Sega Dreamcast console.

2. Plug your Sega Dreamcast Controller into Controller Port A.

Note: BUST-A-MOVE 4™ is a 1 to 2 player game. Before turning the Sega Dreamcast power ON, connect the controller or other peripheral equipment into the control ports of the Sega Dreamcast.*

3. Switch on the power to your Sega Dreamcast Unit.

4. You will be prompted to select a Visual Memory Unit (VMU) on which to save your progress in the game. Each saved game requires 15 blocks of memory. If you do not have a VMU or it does not have adequate blocks to save the game data, you will be alerted but may continue playing.

While saving a game file, never turn OFF the Sega Dreamcast power, remove the memory card or disconnect the controller.

**Purchase additional controllers (sold separately) to play with two people.*

To return to the title screen at any point during game play, simultaneously press and hold the A, B, X, Y and START Buttons. This will cause the Sega Dreamcast to soft-reset the software and display the title screen.

Operation with incompatible controllers is not guaranteed.

SEGA DREAMCAST HARDWARE UNIT



VISUAL MEMORY UNIT (VMU)

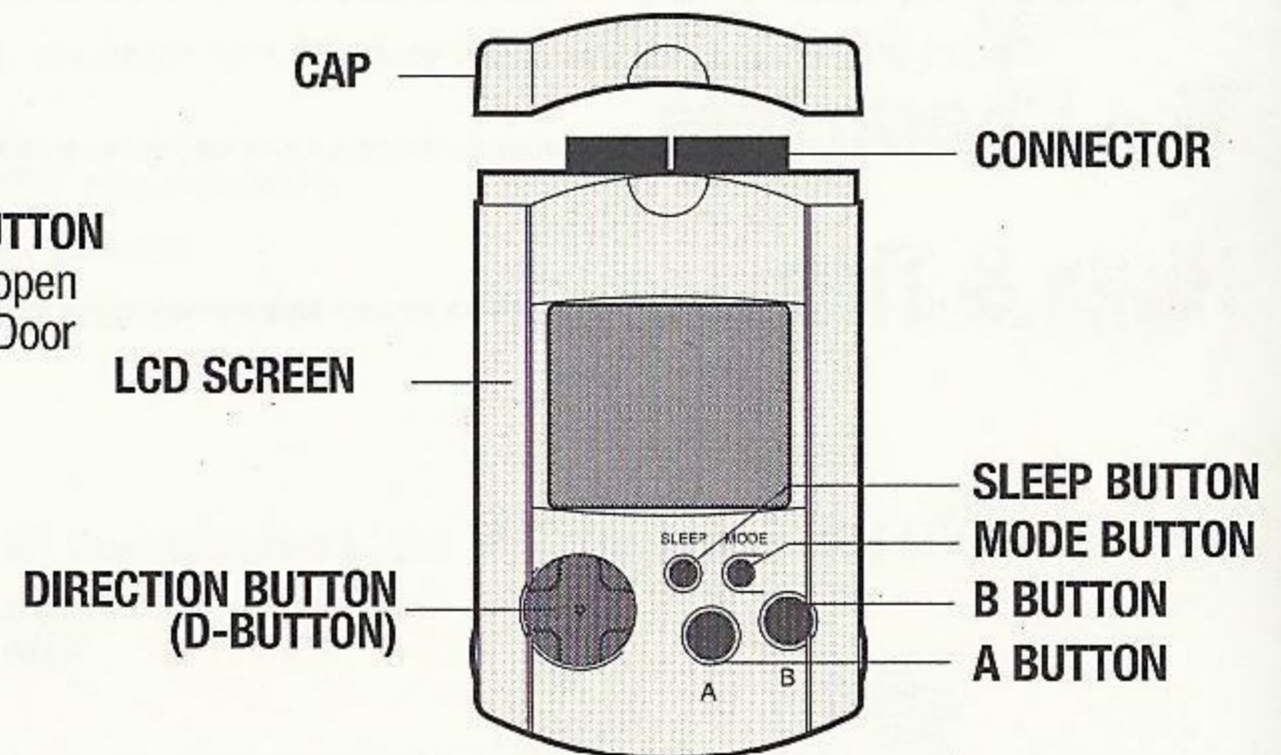

Never disconnect the VMU/VMs while performing a battle or exchanging data when connected to another VMU/VM. Also note that leaving two VMU/VMs connected for a long period of time will considerably shorten the life of the batteries.

A BEDTIME STORY

A peaceful day ends with a wild night when a character is awoken from a deep sleep by a visit from Cronoa, Governess of the Future. She comes to warn of a dire situation, and to ask your help. The Arcana, mystical cards, have fallen into the dimensional cracks we call dreams. The energy of each card will be out of balance unless someone brave and skillful can enter the dream world and seal each card. Each card has five challenging puzzles which must be solved in order to seal the card. It won't be easy, but Cronoa—and the whole universe—are counting on you to see this difficult task through to the end! If you meet this challenge, you will be greatly rewarded. Do your best to burst the bubbles and seal the cards!



DEFAULT CONTROLS

Controls shown are for Configuration A. You can choose from three configurations by selecting Controller from the Options menu.

STANDARD CONTROLLER (Overhead View)

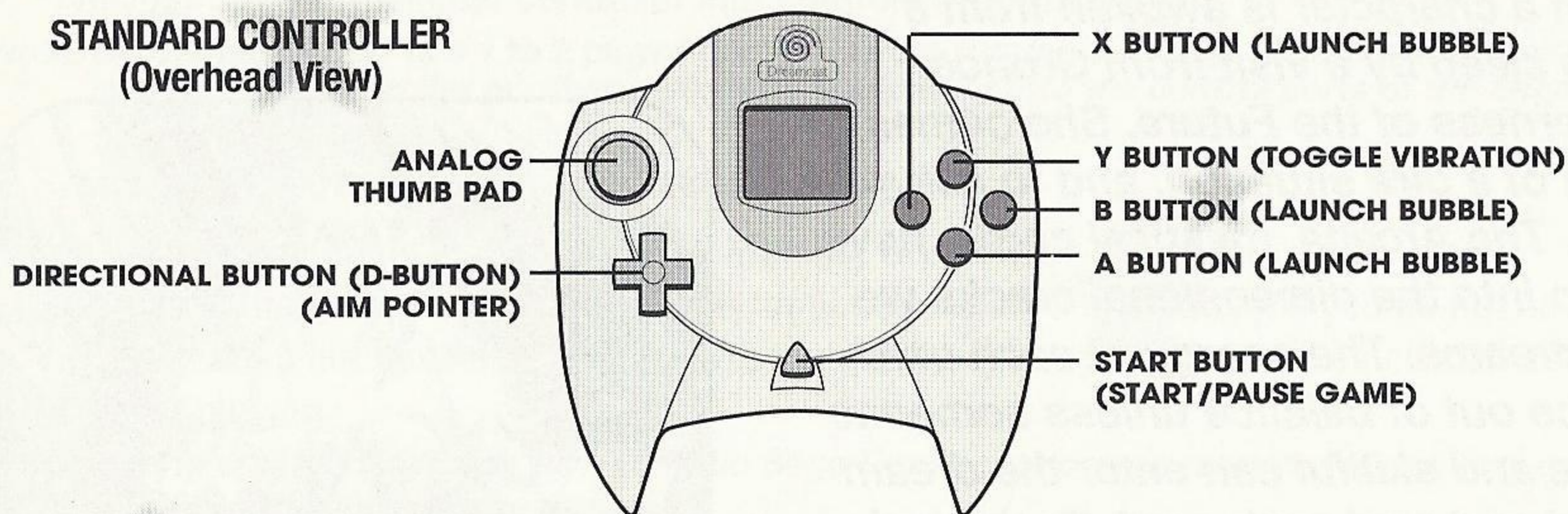

STANDARD CONTROLLER (Forward View)

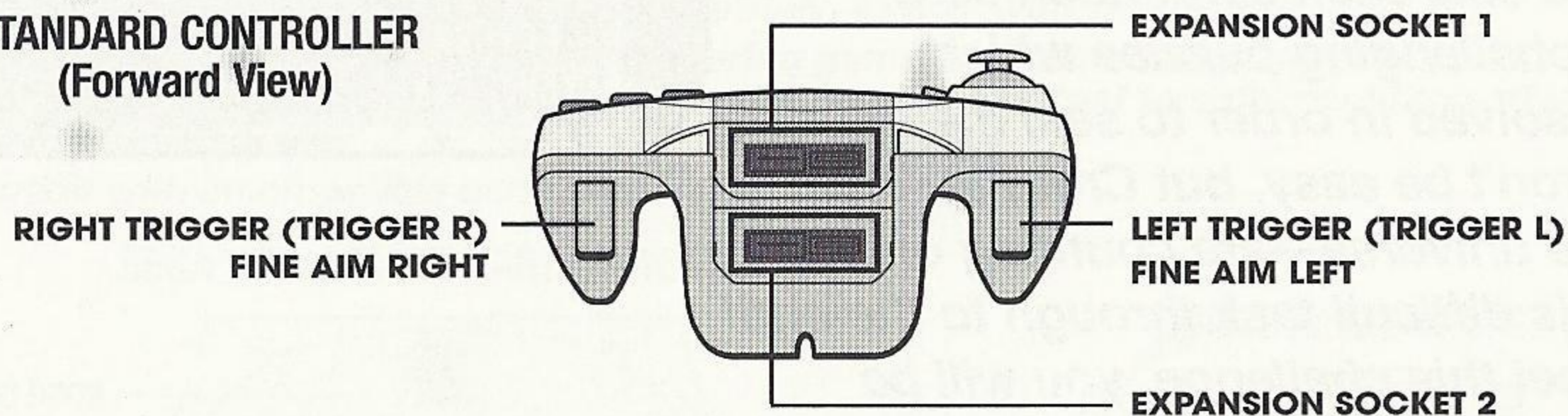

Never touch the Analog Thumb Pad or Triggers L/R while turning the Sega Dreamcast power ON. Doing so may disrupt the controller initialization procedure and result in malfunction.

JUMP PACK

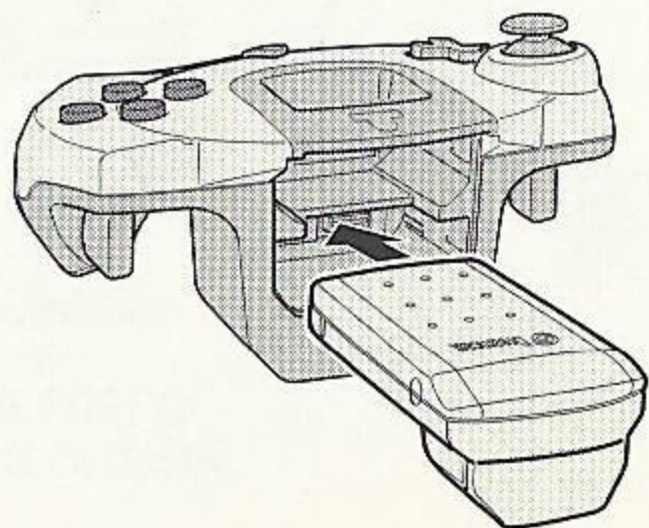

When the Jump Pack/Vibration Pack is inserted into Expansion Socket 1 of the Sega Dreamcast Controller, the Jump Pack/Vibration Pack does not lock into place and may fall out during game play or otherwise inhibit game operation.

MENU CONTROLS

- **UP** or **DOWN DIRECTIONAL BUTTONS** to highlight item.
- **LEFT** or **RIGHT DIRECTIONAL BUTTONS** to toggle settings.
- **A BUTTON** to Confirm selection/advance.
- **B BUTTON** To Cancel selection/go back.

PAUSE MENU

Press the **START BUTTON** to pause the game. Press the **Y BUTTON** to view the pause options menu.

Return to Game

Return to the game where you paused it.

Screen Adjust

- Press **DIRECTIONAL BUTTON + LEFT TRIGGER** to adjust the screen display to suit your monitor.
- Press **DIRECTIONAL BUTTON + RIGHT TRIGGER** to toggle Game Info Text (score display) up or down.
- Press the **B BUTTON** to use **HOME SETTINGS** (default settings).
- Press the **X BUTTON** to use **ARCADE SETTINGS** (text is higher on screen).
- Press the **A BUTTON** to toggle on-screen text **ON** or **OFF**.
- Press the **Y BUTTON** to return to the **PAUSE MENU**.

Back to Menu

Appears only in **COLLECTION MODE**. Returns you to the "Board Select Menu".

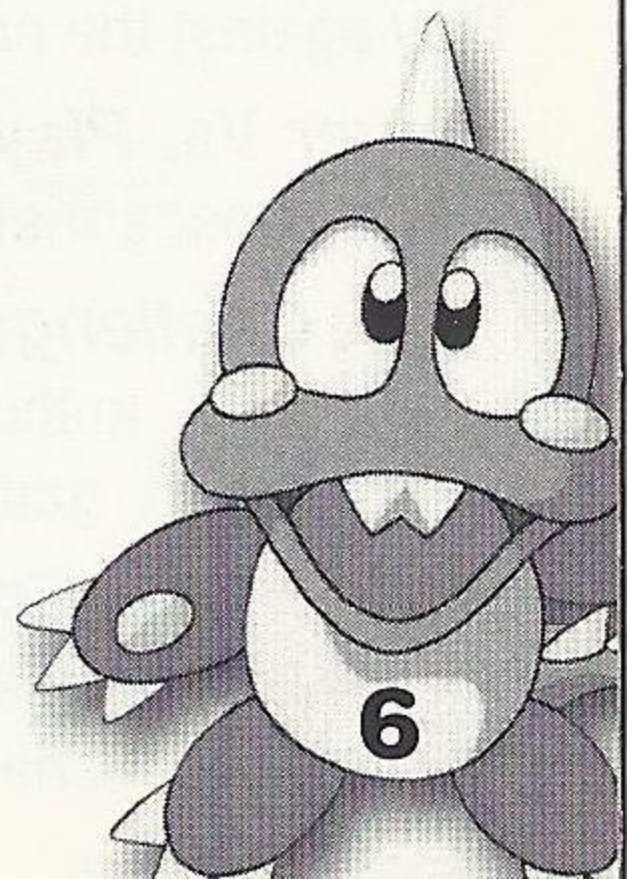

Quit Game

To exit the game, highlight Quit Game and press the **A BUTTON**.

NOTE: The play instructions are based on the Type A control configuration (default).

STARTING OUT

At the title screen, press the **START BUTTON**. You will come to the Game Menu screen, where you can choose one of 5 game modes or set your Options.

GAME MENU

Press **UP** or **DOWN** on the **DIRECTIONAL BUTTON** to make your choice, then press the **A BUTTON** to confirm it. We'll go into more detail on each mode a little later, but first let's check out the **OPTIONS** and go over some **BASIC RULES**.

GAME MODES

Puzzle

Begin your quest to save the Arcana here.

Player Vs. Computer

Play against the computer in a battle of wits!

Player Vs. Player

Play against a friend! This option is unavailable when only one controller is plugged in.

Challenge

In this mode, you're given certain conditions for clearing each round. Your gameplay will be evaluated when you clear all stages.

Edit

Create and play your own puzzles! Save puzzles or load previously saved puzzles. See page 15 for details.

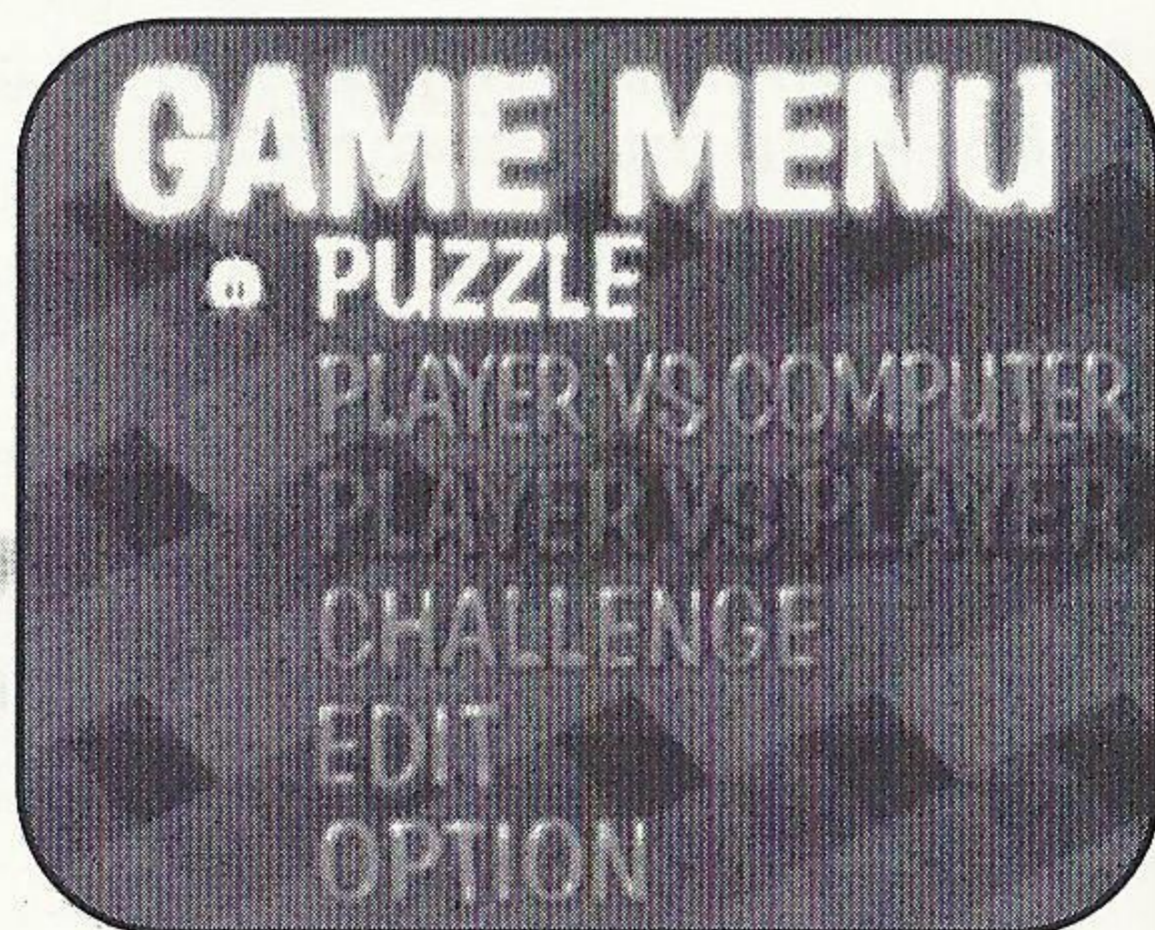

OPTION

There are four main option categories: Game, Controller, Sound and Memory Card. Highlight a category and press the **A BUTTON** to select it. On the next menu, press **UP** or **DOWN** on the **DIRECTIONAL BUTTON** to make your selection and **RIGHT** or **LEFT** on the **DIRECTIONAL BUTTON** to modify digits and other conditions such as difficulty level. In all cases, Exit returns you to the previous screen with current settings intact.

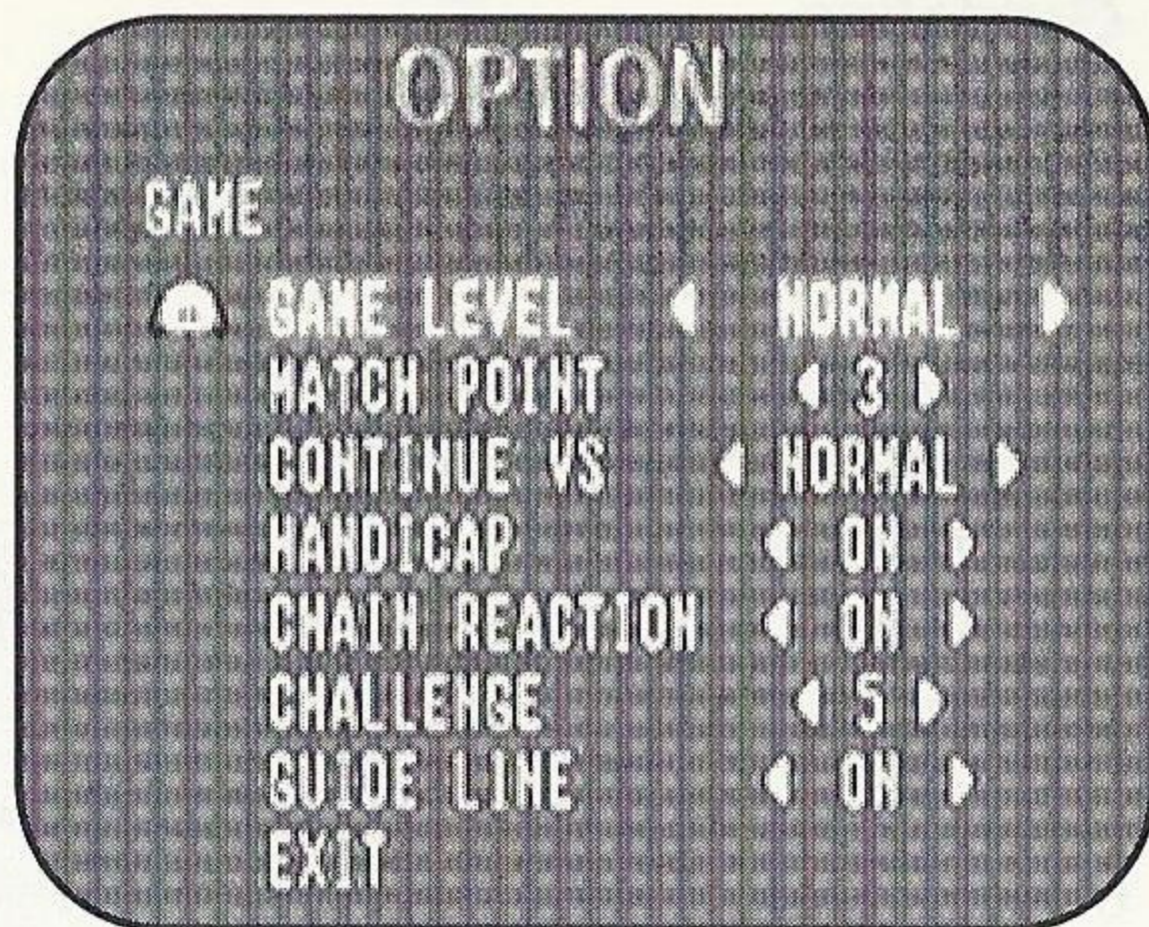

GAME

Select Game options to alter game settings.

Game Level

Choose from four difficulty levels.

Match Point

Choose the number of rounds to play in Player vs. Player and Player vs. Computer games.

Continue Vs

Choose whether continues are Simple or Normal in Player vs. Player and Player vs. Computer games.

Handicap

Choose to play with the handicap **ON** to keep games close, or **OFF** for an honest match.

Chain Reaction

When **ON**, certain combinations of bubbles will cause chain reactions in Vs. mode games, popping lots of bubbles. Try it!

Challenge

Set the number of puzzles (1-5) in each challenge stage.

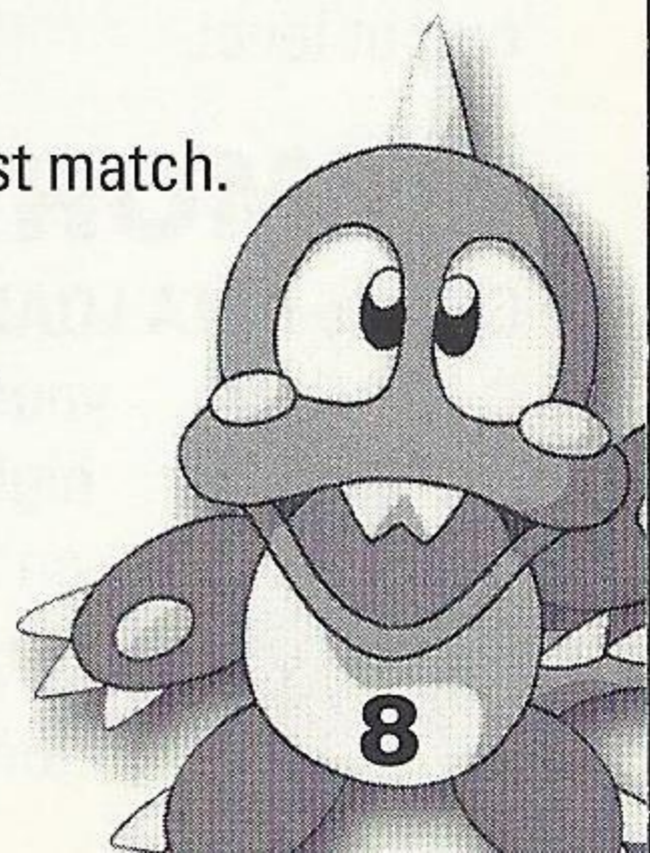

Guideline

The guideline helps you aim your bubbles. When set to **ON**, it appears if you choose to Continue after failing to clear a puzzle. The guideline cannot be turned off in Practice mode. If you set the handicap to "1", you can also play with the guideline in Player vs. Player.

CONTROLLER

Key Config

Choose from three available pre-set button combinations.

1P Vibration

If you have a Sega Jump Pack inserted in the Expansion Socket of the Sega Dreamcast Controller, you can set the strength of the vibration from Low to High.

2P Vibration

See above.

SOUND

Sound Mode

Toggle between Mono and Stereo Sound.

Music Volume

Adjust the in-game music output level.

SE Volume

Adjust the in-game sound effects output level.

SE Load

Load specific sound effects for each character featured in the game.

SE Test

Listen to the loaded sound effects.

Exit

Return to Options Menu.

MEMORY CARD

Choose **DATA LOAD** to load your saved puzzles from Edit mode. Choose **DATA SAVE** to save your puzzles. Toggle **AUTO SAVE OFF** (to save manually) or **ON** (to save your high scores or Story mode progress automatically). (See Saving/Loading Data on page 17 for more details).

EXIT

Returns to the **OPTION** screen.

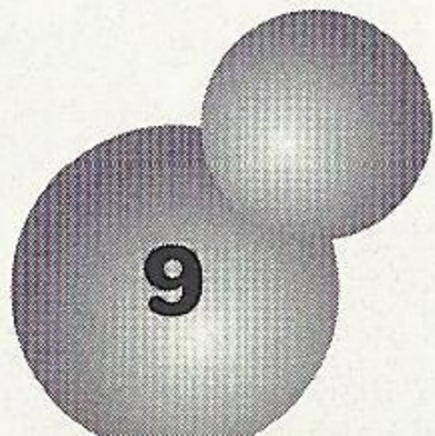

THE SCREEN

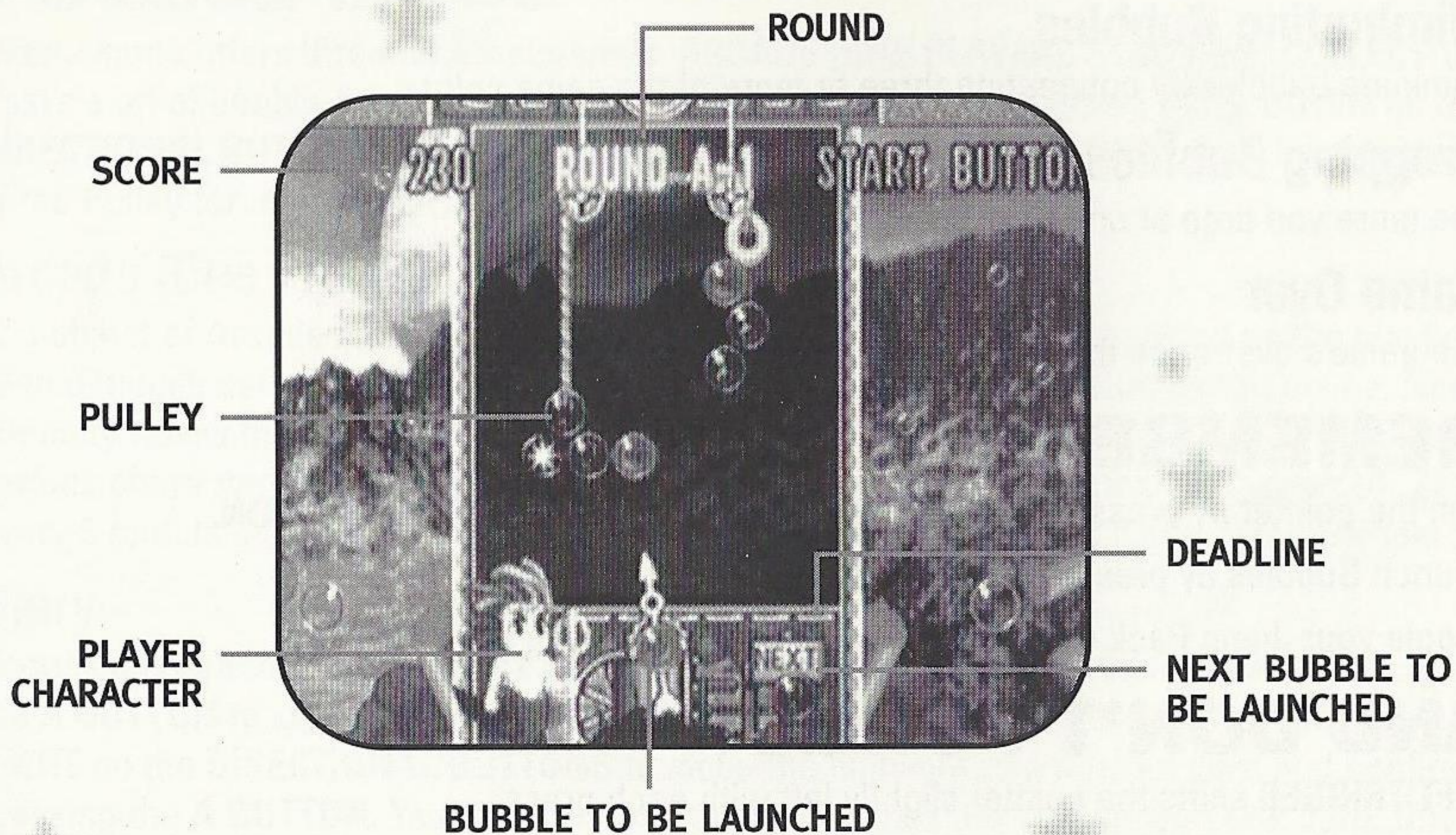

Score

Current total score.

Round

Current round number.

Deadline

Your game's over once the bubbles on the playfield cross this line.

Pulley

When a puzzle has a pulley, be careful how the bubbles balance.

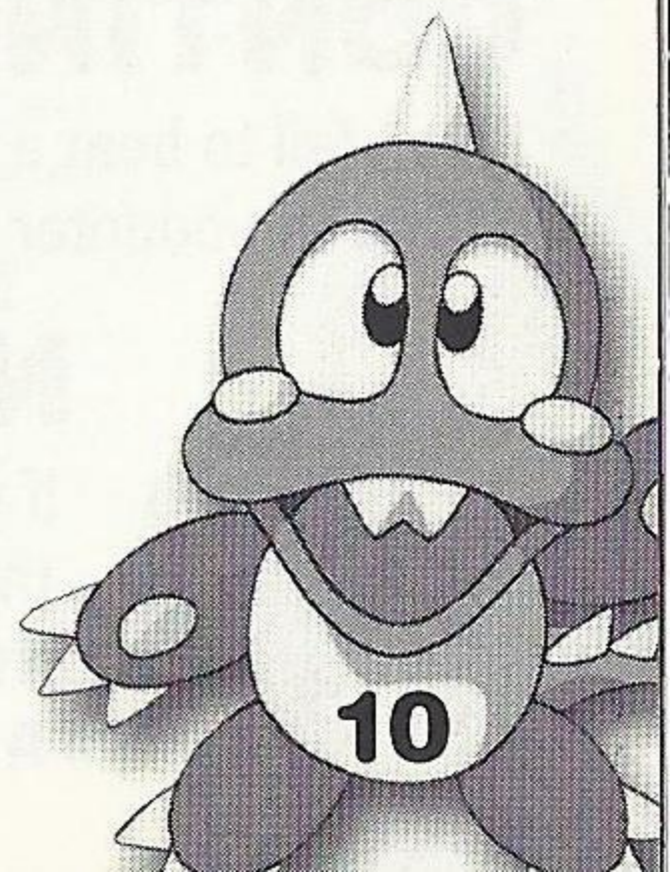

BASIC RULES

Fire bubbles from your launcher and eliminate bubbles before they push past the **DEADLINE**.

Eliminating Bubbles

Eliminate bubbles by connecting three or more of the same color.

Dropping Bubbles

The more you drop at one time, the higher your score!

Game Over

The game's over once the bubbles push past the **DEADLINE**.

REMEMBER

Aim the pointer by pressing the **LEFT** or **RIGHT** on the **DIRECTIONAL BUTTON**.

Launch Bubbles by pressing the **A, B** or **X BUTTON**.

Toggle your Jump Pack from "High" to "Low" to "Off" with the **Y BUTTON**.

AND DON'T FORGET

LEFT TRIGGER shifts the pointer slightly left with each press.

RIGHT TRIGGER shifts the pointer slightly right with each press.

CONTINUE

If you fail to beat a puzzle, a countdown will start. To continue play, press the **START BUTTON** before the counter reaches 0. You have unlimited Continues.

NAME ENTRY

If you achieve a high-ranking score you can record your name (up to three characters). Just choose a character by pressing **LEFT** or **RIGHT** on the **DIRECTIONAL BUTTON**, and confirm your selection by pressing the **A BUTTON**.

GAME MODES

PUZZLE MODE

Puzzle mode offers three different games: **ARCADE (ONE PLAYER)**, **STORY** and **COLLECTION**. That's a lot of bubble-busting fun! Select the desired mode by pressing **UP** or **DOWN** on the **DIRECTIONAL BUTTON** and start the mode by pressing the **A BUTTON**. Select Explanation of the Pulley for information on how the pulley system works.

Arcade (One Player)

The object of Arcade mode is to clear a round by eliminating all the bubbles on the playfield. With difficulty set on "**EASY**", you'll play with help from the bubble launcher guideline. Normal difficulty raises the level to average and eliminates the guideline. Remember, the abilities of the various characters are not applied in this mode. You are offered a choice of routes (A- Z) for every 5 rounds that you clear. An ending sequence will be displayed if you clear the final zone.

Story

Choose a character, then sit back as the story of Cronoa, Keeper of the Future unfolds (press the **A BUTTON** to skip the story). Then select any of several available cards by pressing **LEFT** or **RIGHT** on the **DIRECTIONAL BUTTONS** to move the highlight to a desired card and confirm by pressing the **A BUTTON**. You will then play the five puzzles associated with that card. Once you have mastered these puzzles, that card is sealed and you can choose any of the remaining cards. Continue in this way until you have completely sealed all the cards. It is a long process, but once you have sealed all the cards, you will get a special surprise!

Collection Mode

Collection mode offers a vast collection of some of the best **BUST-A-MOVE** puzzles ever created. There are over 200 different puzzles from our top designers, so hunker down for a funfest!

- Press **LEFT** or **RIGHT** on the **DIRECTIONAL BUTTON** to select the round you wish to play.

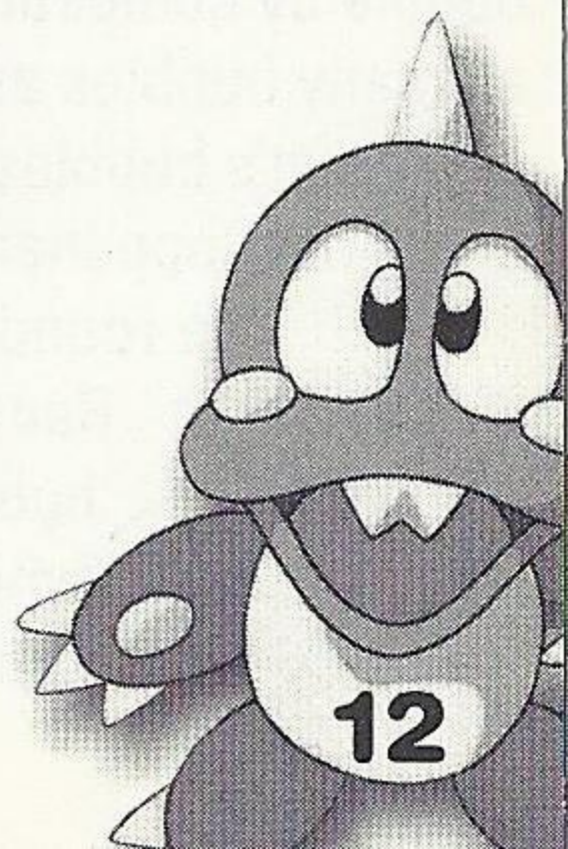

- You can skip up or down 10 rounds by pressing **UP** or **DOWN** on the **DIRECTIONAL BUTTON**.
- You can skip up or down 1 round by pressing **LEFT** or **RIGHT** on the **DIRECTIONAL BUTTON**.
- Selecting **END** will return you to the title screen.
- After selecting the screen of your choice, press the **A BUTTON** to begin play.
- The following menu is displayed, after clearing a round.

TRY AGAIN Replay the current puzzle.

NEXT STAGE Play the next puzzle.

RETURN TO MENU Return to the Round Selection screen.

EXIT Return to main menu.

PLAYER VS. COMPUTER

Player vs. Computer mode offers two different games in which you can compete against the CPU-controlled characters: Story and Win Contest. That's twice as much bubble-busting fun! Select the desired mode by pressing **UP** or **DOWN** on the **DIRECTIONAL BUTTON** and start the mode by pressing the **A BUTTON**. Select Explanation of Chain Reaction for information on how the chain reaction system works.

Story (Player Vs. Computer)

Choose a character and listen to the story of the Rainbow's theft. The Moon Queen has stolen all of the bubble colors that make up the rainbow. It is your job to win back each colored bubble by competing against CPU-controlled characters on a round-by-round basis. Eliminate as many bubbles as possible or drop bubbles into your opponent's playfield. You win when your opponent's bubbles push past the **DEADLINE**. When you win, you proceed to the next round and a new opponent as the story continues. The game is over when you lose a round. An ending sequence will be displayed when you clear the last round.

Remember, the character you select is directly related to the type of bubbles you drop on your opponent (the character select screen illustrates which bubbles will be dropped on your opponent when you complete each chain reaction).

Win Contest

Choose a character and compete against each CPU-controlled character to build up a succession of wins. One loss ends the game. Each win reveals more of the puzzle (you'll get a glimpse of the puzzle even if you lose but more wins unscrambles it even more!). Follow the same rules as Story mode to defeat your opponent.

PLAYER VS. PLAYER

Select your player. Press either **LEFT** or **RIGHT** on the **DIRECTIONAL BUTTONS** to select and confirm your selection with the **A BUTTON**. Then you can select a handicap that will even the playing field if you and your partner's skill levels differ. From here, the rules are the same as Player vs. Computer but this time it's your buddy (not some CPU opponent) you're dumping bubbles on! Remember, the character you select is directly related to the type of bubbles you drop on your opponent (the character select screen illustrates which bubbles will be dropped on your opponent when you complete each chain reaction).

CHALLENGE MODE

Challenge mode offers 5 different challenge stages, each with 5 rounds. Try your hand at each different challenge, then see how you did in the evaluation screen!

Stage Map

On the **CHARACTER SELECTION SCREEN**, choose a character by pressing **LEFT** or **RIGHT** on the **DIRECTIONAL BUTTON** and decide your choice with the **A BUTTON**. The composition of the rounds will vary in accordance with the selected character.

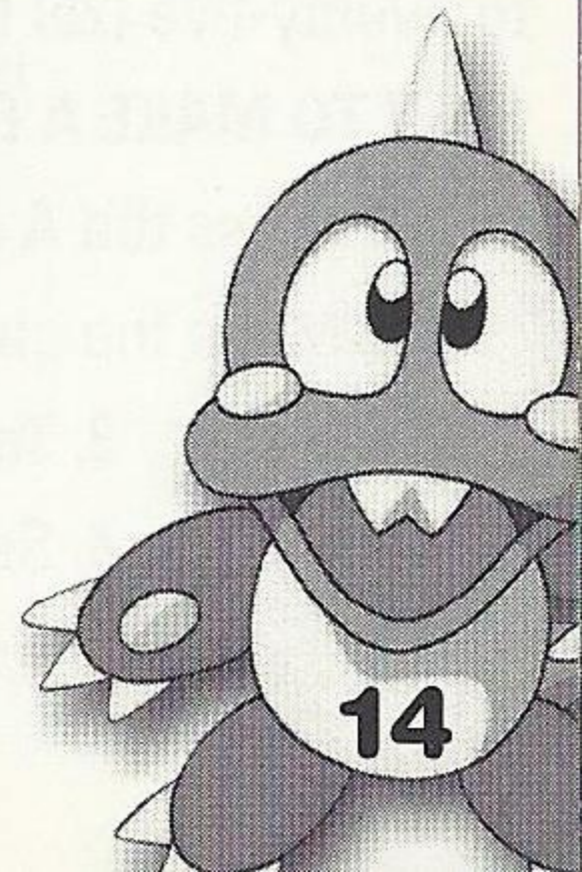

Begin Gameplay

Each stage commences with 5 rounds. Clear the stage for a higher score. You will progress even if you don't clear the stage but your score will be significantly lower.

Stage Evaluation

Once you've cleared each stage, an evaluation screen will be displayed, followed by the next stage of the game.

Grade

When all stages are cleared, the player will be graded according to performance and technique.

EDIT MODE

When you select Edit Mode in the Mode Selection screen it will take you to the Edit Menu screen, where you can select Puzzle Set Up to create a puzzle or Puzzle Play to play your created puzzle(s).

PUZZLE SET UP

Place bubbles on the field anywhere you like to construct an original puzzle. You can save up to twenty-five (25) total original puzzles.

HOW TO MAKE A PUZZLE SCREEN

1. Press the **A BUTTON** to choose Puzzle Setup.
2. Move the cursor with the **DIRECTIONAL BUTTON** to position the bubbles.
3. Toggle bubble types by pressing the **LEFT TRIGGER** or **RIGHT TRIGGER**.
4. Set the bubbles by pressing the **A BUTTON**. Delete bubbles by placing the cursor over the bubble and pressing the **B BUTTON**.

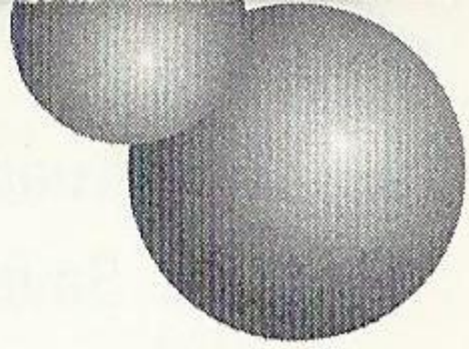
- 
5. You cannot test play on a puzzle that has only a Star Bubble and a Block Bubble, or on a puzzle where no bubbles touch the ceiling or an anchor ball. (If such a screen appears in "Puzzle Play," the game will just end.)
 6. Press the **X BUTTON** to see the Puzzle Setup Edit Menu.

THE EDIT MENU

When you press the **X BUTTON** while on the Puzzle Setup screen, the Edit Menu window opens. You can change these settings in Edit:

Random Color

You can set random color. You can choose the color of a displayed bubble via the **ON/OFF** Button (you cannot choose **OFF** for all colors).

Delete Map

This will delete all the bubbles that are placed in the field.

Playfield Size

When you select Playfield Size and finalize your selection, the field size will change from wide to normal, or vice-versa.

Round Selection

Select the round to be constructed. If you do not construct 25 rounds and you select **PUZZLE PLAY**, your game will be over after the last round you built.

Round Data

COPY Copies edited data to the designated round.

EXCHANGE Replaces data with the designated round's edited data.

Test

Select Test to play a test round using the puzzle you are currently editing. You can return to the Edit screen when you clear or lose the round.

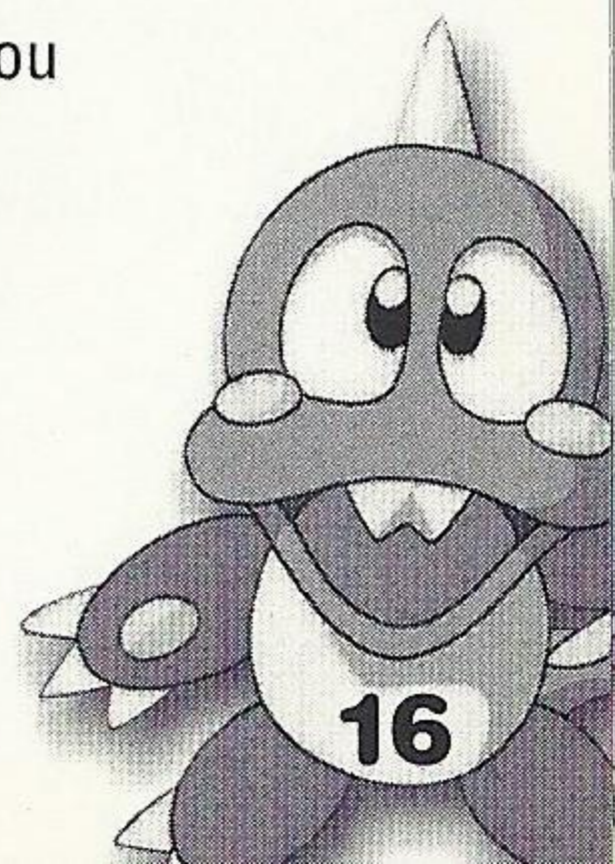

Save/Load

LOAD Loads saved Edit Data (1st - 25th screens).

SAVE Saves data (1st - 25th screens) that has been edited.

EXIT Return to Menu Screen.

Only Edit Mode maps can be saved. You must have a memory card to save Edit Mode data.

Select Save/Load on the Edit Menu. Press **UP** or **DOWN** on the **DIRECTIONAL BUTTON** to select **SAVE** or **LOAD**, then press the **A BUTTON**. You will be prompted to confirm your choice (Are you sure you wish to **SAVE/LOAD? YES** or **NO**). Highlight **YES** or **NO** and press the **A BUTTON**.

Exit

Return to the Game Menu.

PUZZLE PLAY

Play the course you created! Basic rules are the same as in a Puzzle Game. There are five courses and five rounds per course. Once you clear an entire course, you are taken to the Course Transfer screen and sent to the next course. Once you complete the 5th course, the game is over. Unless you make all 25 screens in advance, the game will conclude at the time all self-made courses have been beaten.

SPECIAL BUBBLES

The bubbles described below have special properties.



STAR BUBBLE

Contact with a bubble will eliminate all bubbles of the same color.



RAINBOW BUBBLE

When in contact with an eliminated bubble, it will adopt the color of that bubble.

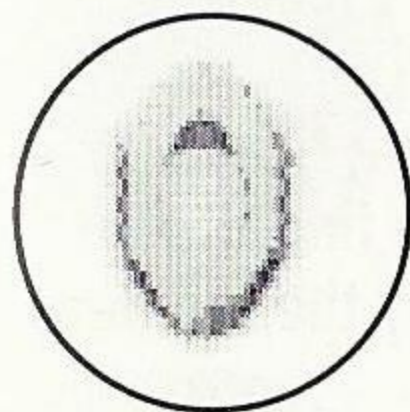

BLOCK BUBBLE

Although blocks can't be eliminated, you can still clear a round whether they're on the playfield or not.

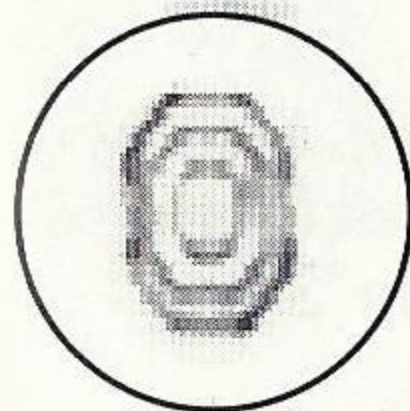

BUBLOCK BUBBLE

Similar to Block Bubbles, a Bublock can be removed by eliminating all the surrounding bubbles in contact with it. However, you cannot clear a round if a Bublock is still on the playfield.

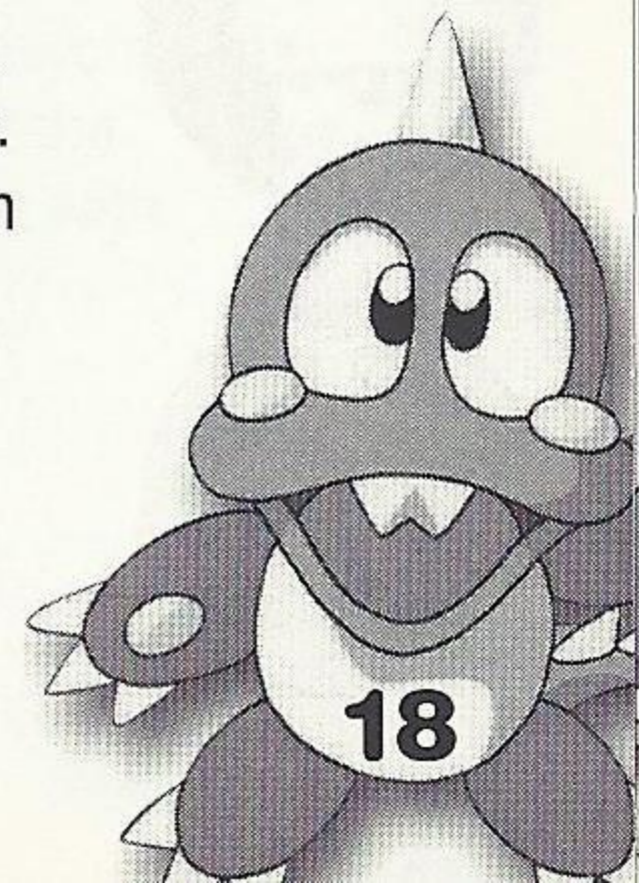

THE CHARACTERS

Depending on the opposing character, bubble-attack combinations will vary.



BUB and BOB

The twin brothers who live on the Planet Bubbleluna. Bub is the older brother. He is energetic and cheerful. Bob, the younger of the twins is the quiet, reserved type. The twins are the heroes of this story.



ALKANET

She is a graceful princess from the planet Freeze. She is tough-minded and loves her planet. Woe be to anyone who causes harm to her planet. She is willing to take a voyage in order to retrieve the lost color bubbles.



MARINO

He's the son of Queen Naletto of the planet Wavy. He's a straight forward character, but a bit of a simpleton. He embarks on a journey to find the "morning", because the Kingdom of the Sea was roughed up by the incident.



KUROL

She is a Baby from the Grrrrmm planet where people are always costume-clad. She is a laid-back character who loves to sunbathe and take naps. Her journey will be in search of the "morning" and the afternoon "Siesta." Both of which remain missing.

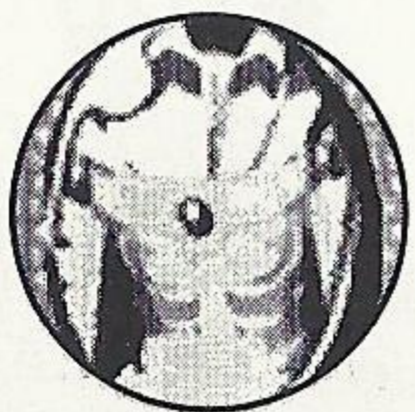

TAMTAM

He is the Lord Protector of the divine Navajo planet. He is the father of the wind and the earth, and is capable of being hostile or gentle. He senses incidents of evil, and soars into space in pursuit of the wonders of night...the night which now never ends...the morning which never comes.



CLEON

The Fairy of the Night. She is upbeat and mischievous. She is the subordinate of Full Moon Madame Luna, who is the main character involved in the incident. Cleon secretly harbors ambitions to overthrow Madame Luna, and assume the title of The Conqueror of the Night.



GIGANT

He is a chief security guard at a once magnificent but now ruined castle on the planet Gothic. He continued to protect the castle despite the devastation around him. But one day, he fell under the seductive beauty of a rainbow bubble and for the first time felt the power to follow his own will: "I want that beautiful thing."



DEVELON

He is the alter-ego of BAT who lives on the Planet Diable. He's always conspiring to cause harm and inflict damage, and he is the arch-rival of Bub and Bubbleloon. However, truth be told, he is nothing more than a lonely coward.



BRAMB

He is a mad sorcerer from the planet Marzuk. He had been devoting a great deal of time to developing his ultimate magic trick, which was near completion when light, the main source of his pending research, suddenly vanished! When he finally learned the truth about the incident, he immediately began to plot a way to control light with the rainbow bubbles.



G

An old, mysterious man who lives on the planet Ordeaux. No one knows his real name, and everyone refers to him only as G. There's a rumor that he likes tea. Also, when he is sharp he is quite fearful...?

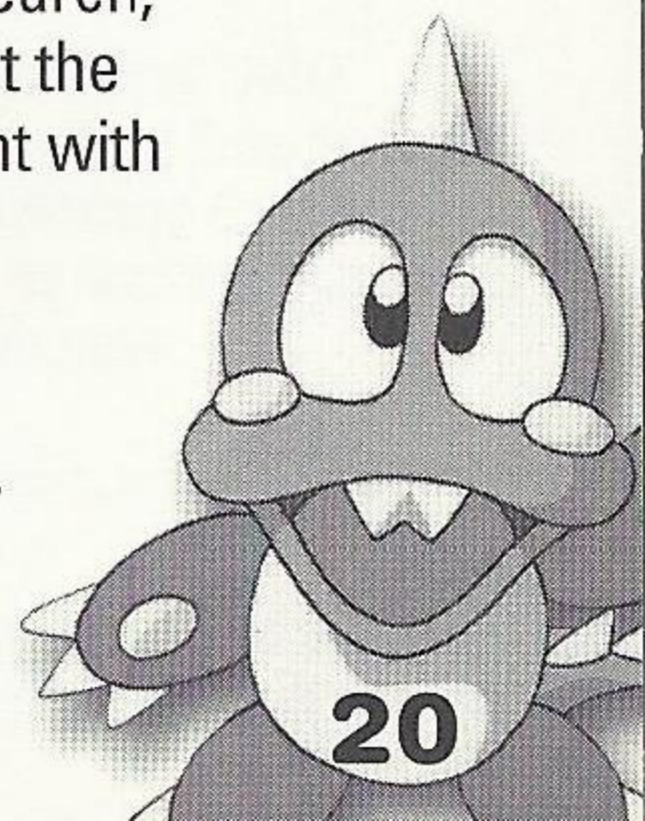

HINTS & TIPS

1. Study the way the puzzle is constructed, and how the bubbles are suspended. Note which bubbles are "linchpin" bubbles (bubbles which have a string of bubbles suspended from them). Often, eliminating a particular strategically placed bubble will cause an entire puzzle to give way!
2. Practice bouncing/angling your shots off the sides. This is the true way to mastering the game. Once you're good at doing this, you'll be able to pull off the tough shots that save the day!
3. Fire rapidly! As soon as you have your shot lined up, don't hesitate, shoot! Fire one right after another when bubbles are the same hue.
4. Watch your indicator to see what the next bubble is. A big part of a successful strategy is aiming the current bubble in anticipation of where you'll shoot the next one!
5. When playing an opponent (Human or CPU), make sure to set up your shots immediately. This means hanging a few bubbles off of two like-colored bubbles so that you'll be able to send "blocking" bubbles over to your opponent after you've dropped your bundle!

For the hottest hints and codes on Acclaim Titles Please call 1-900-407-Tips(8477).

The cost of the call is \$.95 per minute. You must be 18 or have parental permission and have a touch-tone phone.

ACCLAIM® LIMITED WARRANTY

ACCLAIM warrants to the original purchaser only of this ACCLAIM software product that the medium on which this software program is recorded is free from defects in materials and workmanship for a period of ninety (90) days from the date of purchase. This ACCLAIM software program is sold "as is," without express or implied warranty of any kind, and ACCLAIM is not liable for any losses or damages of any kind resulting from use of this program. ACCLAIM agrees for a period of ninety (90) days to either repair or replace, at its option, free of charge, any ACCLAIM software product, postage paid, with proof of date of purchase, at its Factory Service Center. Replacement of the software product, free of charge to the original purchaser (except for the cost of returning the software product) is the full extent of our liability.

This warranty is not applicable to normal wear and tear. This warranty shall not be applicable and shall be void if the defect in the ACCLAIM software product has arisen through abuse, unreasonable use, mistreatment or neglect. THIS WARRANTY IS IN LIEU OF ALL OTHER WARRANTIES AND NO OTHER REPRESENTATIONS OR CLAIMS OF ANY NATURE SHALL BE BINDING ON OR OBLIGATE ACCLAIM. ANY IMPLIED WARRANTIES APPLICABLE TO THIS SOFTWARE PRODUCT, INCLUDING WARRANTIES OF MERCHANTABILITY AND FITNESS FOR A PARTICULAR PURPOSE, ARE LIMITED TO THE NINETY (90) DAY PERIOD DESCRIBED ABOVE. IN NO EVENT WILL ACCLAIM BE LIABLE FOR ANY SPECIAL, INCIDENTAL, OR CONSEQUENTIAL DAMAGES RESULTING FROM POSSESSION, USE OR MALFUNCTION OF THIS ACCLAIM SOFTWARE PRODUCT.

Some states do not allow limitations as to how long an implied warranty lasts and/or exclusions or limitations of incidental or consequential damages so the above limitations and/or exclusions of liability may not apply to you. This warranty gives you specific rights, and you may also have other rights which vary from state to state.

This warranty shall not be applicable to the extent that any provision of this warranty is prohibited by any federal, state or municipal law which cannot be pre-empted.

Repairs/Service after Expiration of Warranty—If your software product requires repair after expiration of the 90-day Limited Warranty Period, you may contact the Consumer Service Department at the number listed below. You will be advised of the estimated cost of repair and the shipping instructions.

Acclaim Hotline/Consumer Service Department (516) 759-7800

TAITO is a registered trademark of TAITO CORPORATION. BUST-A MOVE 4™ is a registered trademark of TAITO CORPORATION. © TAITO CORPORATION 1994, 2000. All Rights Reserved. Acclaim® & © 2000 Acclaim Entertainment. All Rights Reserved. Developed by TAITO. All Rights Reserved. RE-VOLT™ & Acclaim® & © 2000 Acclaim Entertainment, Inc. All Rights Reserved. Developed by Acclaim Studios London. All Rights Reserved. Marketed by Acclaim. Distributed by Acclaim Distribution, Inc., One Acclaim Plaza, Glen Cove, NY 11542-2777. www.clubacclaim.com

ESRB RATING

This product has been rated by the Entertainment Software Rating Board. For information about the ESRB rating, or to comment about the appropriateness of the rating, please contact the ESRB at 1-800-771-3772.

Sega is registered in the US Patent and Trademark Office. Sega Dreamcast and the Dreamcast Swirl, are trademarks of SEGA. Sega of America, P.O. Box 7639, San Francisco, CA 94120. All Rights Reserved. Programmed in Japan. Made and printed in the USA. WARNING: Operates only with NTSC televisions and Sega Dreamcast systems purchased in North and South America (except Argentina, Paraguay and Uruguay). Will not operate with any other televisions or Sega Dreamcast systems. Product covered under one or more of the following U.S. Patents: 5,460,374; 5,525,770; 5,627,895; 5,688,173; 4,442,486; 4,454,594; 4,462,076; Re. 35,839; Japanese Patent No.2870538, (Patents pending in U.S. and other countries); Canada Patent No. 1,183,276. The ratings icon is a trademark of the Interactive Digital Software Association.



LOOK
FOR

REVOLT™

www.acclaim.com

Acclaim Entertainment, Inc., One Acclaim Plaza Glen Cove, NY 11542-2777.

Sega is registered in the US Patent and Trademark Office. Sega Dreamcast, the Dreamcast Swirl, are trademarks of SEGA. Sega of America, P.O. Box 7639, San Francisco, CA 94120. All Rights Reserved. Programmed in Japan. Made and printed in the USA. WARNING: Operates only with NTSC televisions and Sega Dreamcast systems purchased in North and South America (except Argentina, Paraguay and Uruguay). Will not operate with any other televisions or Sega Dreamcast systems. Product covered under one or more of the following U.S. Patents: 5,460,374; 5,525,770; 5,627,895; 5,688,173; 4,442,486; 4,454,594; 4,462,076; Re. 35,839; Japanese Patent No.2870538, (Patents pending in U.S. and other countries); Canada Patent No. 1,183,276. The ratings icon is a trademark of the Interactive Digital Software Association.

Acclaim



SEGA