

# ANARCHY RULZ™

Dreamcast™

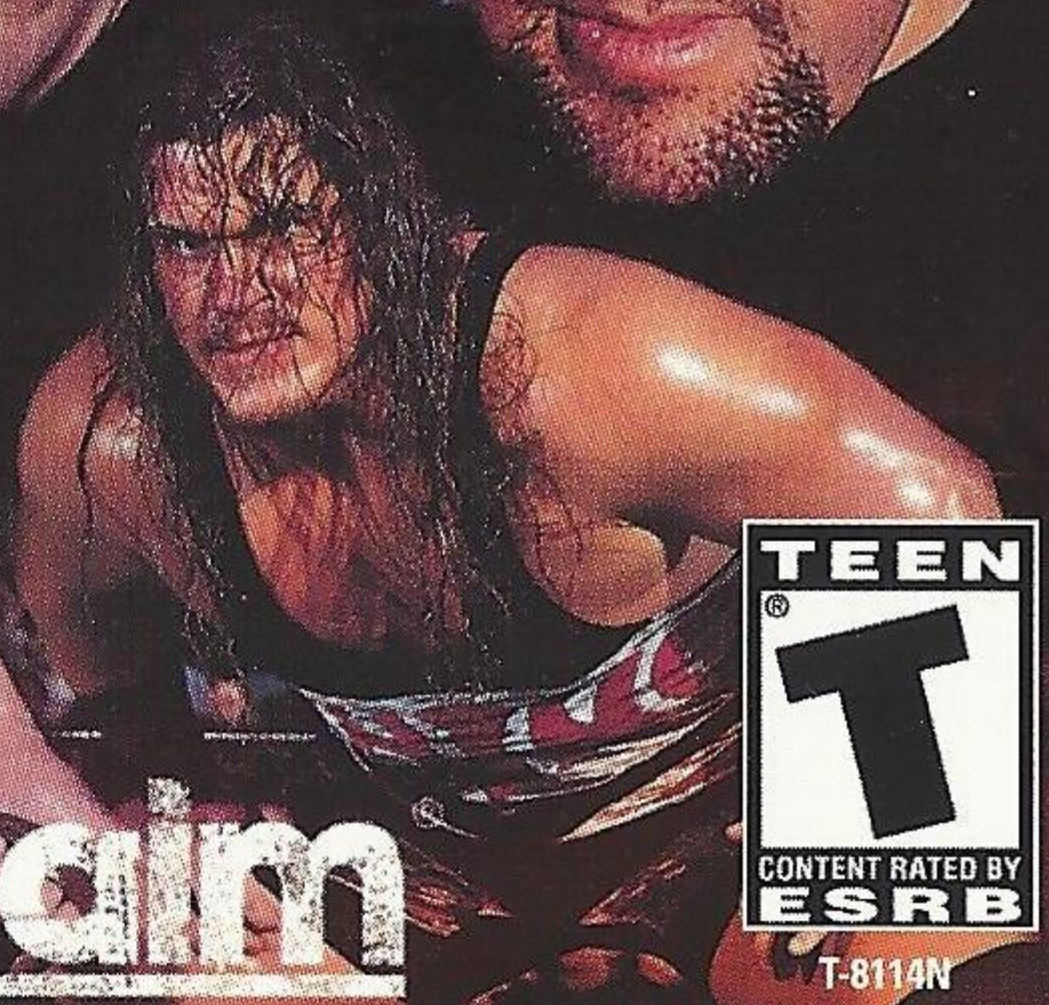

## AKKAIM

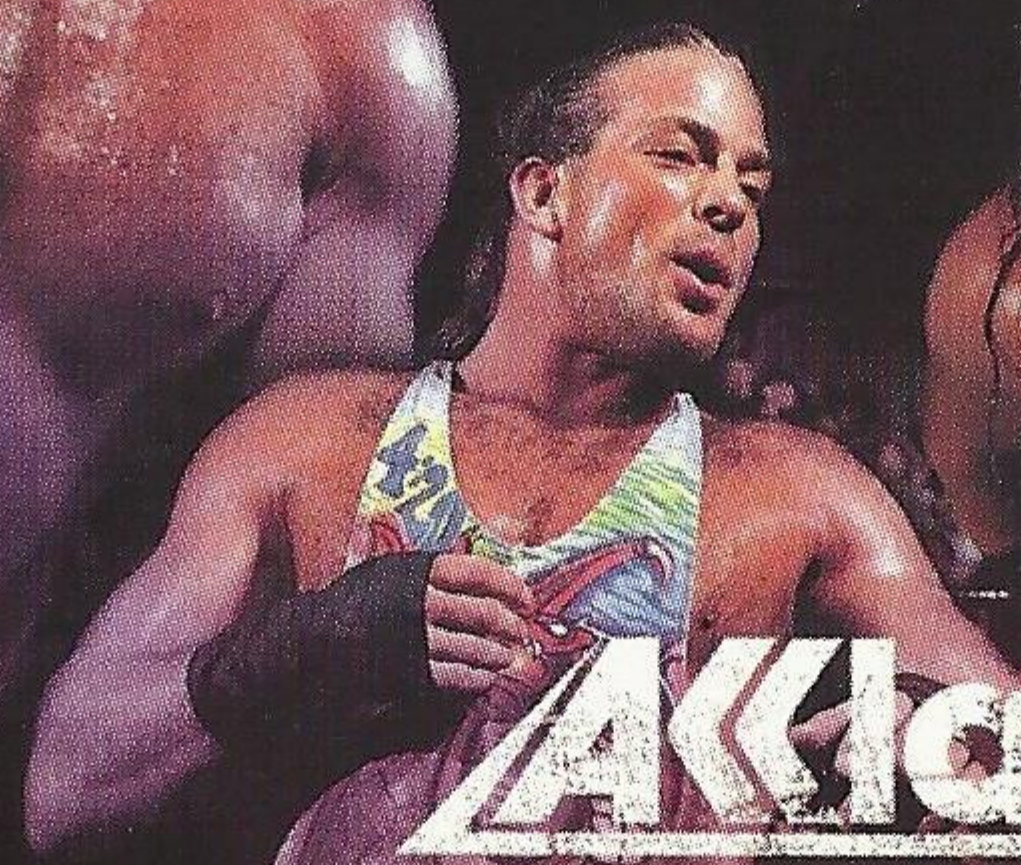
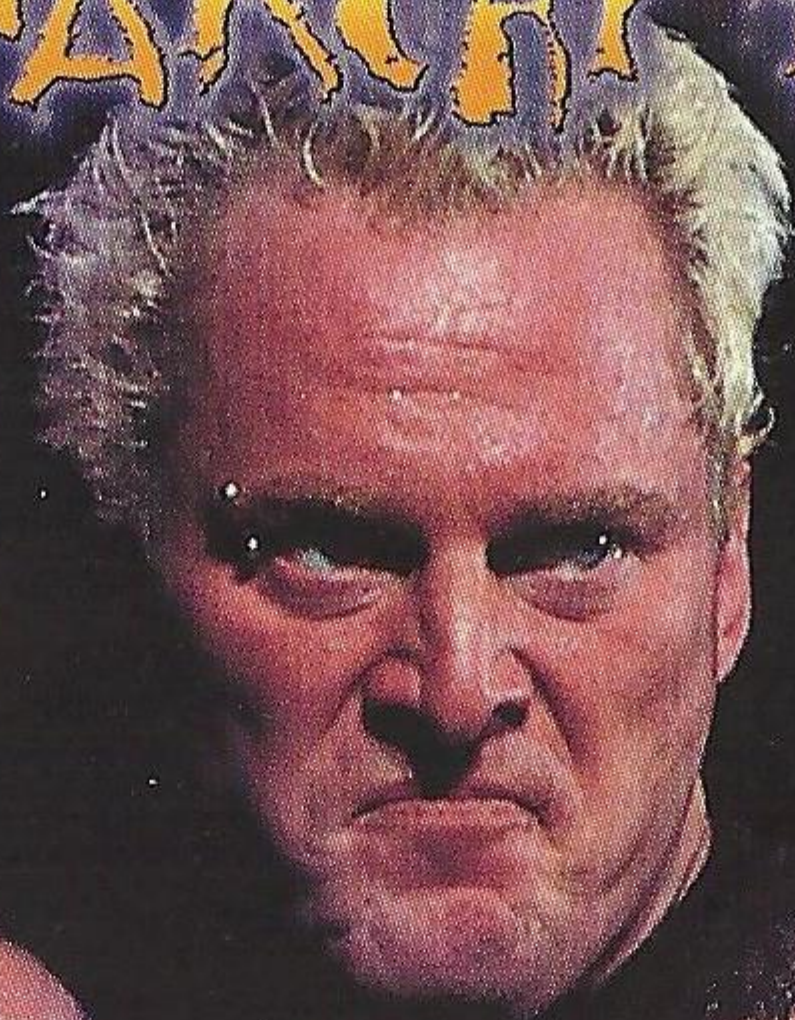
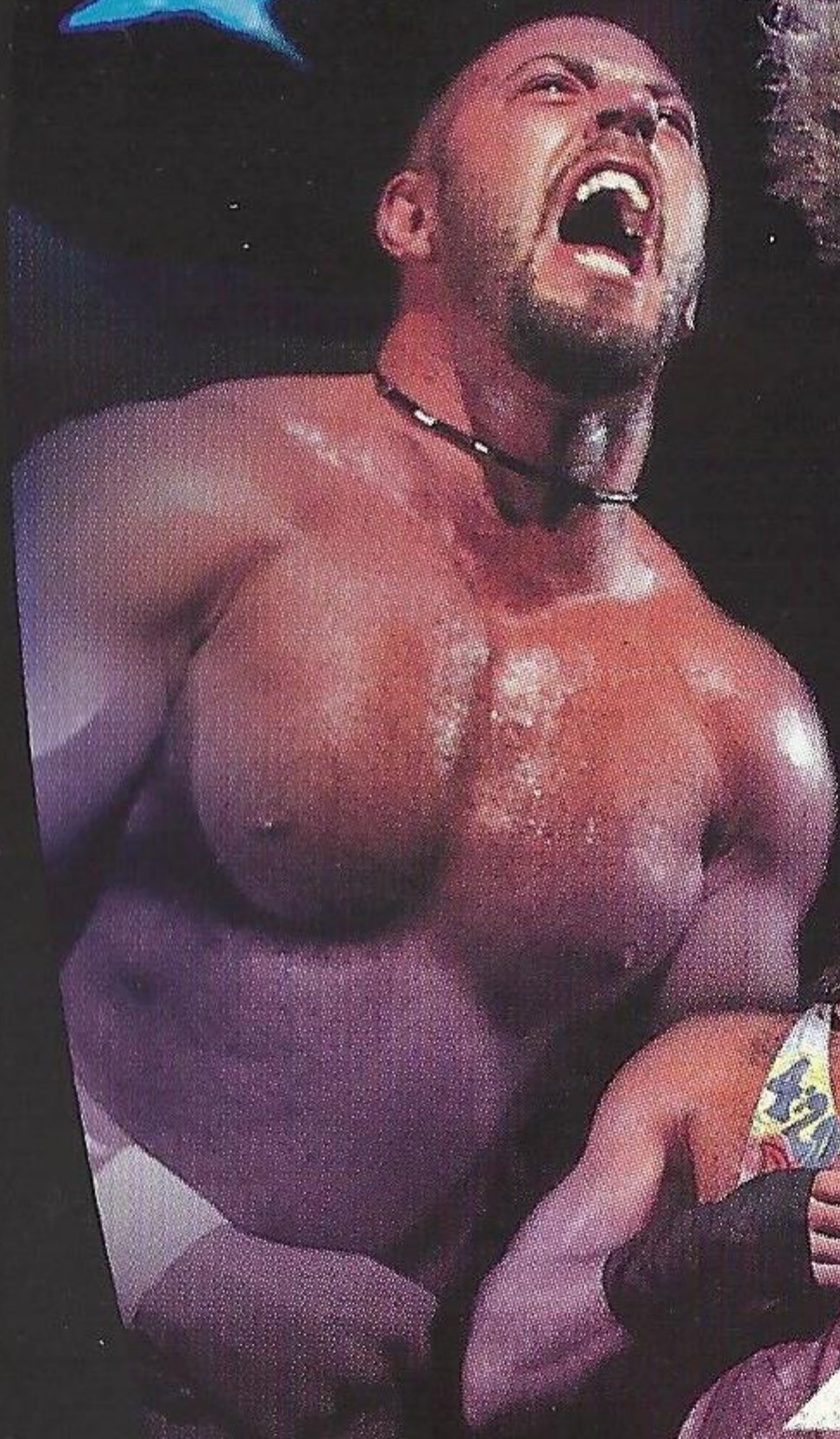

T-8114N



# **WARNINGS Read Before Using Your Sega Dreamcast Video Game System**

## **CAUTION**

Anyone who uses the Sega Dreamcast should read the operating manual for the software and console before operating them. A responsible adult should read these manuals together with any minors who will use the Sega Dreamcast before the minor uses it.

## **HEALTH AND EPILEPSY WARNING**

Some small number of people are susceptible to epileptic seizures or loss of consciousness when exposed to certain flashing lights or light patterns that they encounter in everyday life, such as those in certain television images or video games. These seizures or loss of consciousness may occur even if the person has never had an epileptic seizure.

If you or anyone in your family has ever had symptoms related to epilepsy when exposed to flashing lights, consult your doctor prior to using Sega Dreamcast.

In all cases, parents should monitor the use of video games by their children. If any player experiences dizziness, blurred vision, eye or muscle twitches, loss of consciousness, disorientation, any involuntary movement or convulsion, **IMMEDIATELY DISCONTINUE USE AND CONSULT YOUR DOCTOR BEFORE RESUMING PLAY.**

To reduce the possibility of such symptoms, the operator must follow these safety precautions at all times when using Sega Dreamcast:

- Sit a minimum of 6.5 feet away from the television screen. This should be as far as the length of the controller cable.
- Do not play if you are tired or have not had much sleep.
- Make sure that the room in which you are playing has all the lights on and is well lit.
- Stop playing video games for at least ten to twenty minutes per hour. This will rest your eyes, neck, arms and fingers so that you can continue comfortably playing the game in the future.

## **OPERATING PRECAUTIONS**

To prevent personal injury, property damage or malfunction:

- Before removing disc, be sure it has stopped spinning.
- The Sega Dreamcast GD-ROM disc is intended for use exclusively on the Sega Dreamcast video game system. Do not use this disc in anything other than a Sega Dreamcast console, especially not in a CD player.
- Do not allow fingerprints or dirt on either side of the disc.
- Avoid bending the disc. Do not touch, smudge or scratch its surface.
- Do not modify or enlarge the center hole of the disc or use a disc that is cracked, modified or repaired with adhesive tape.
- Do not write on or apply anything to either side of the disc.
- Store the disc in its original case and do not expose it to high temperature and humidity.
- Do not leave the disc in direct sunlight or near a radiator or other source of heat.
- Use lens cleaner and a soft dry cloth to clean disc, wiping gently from the center to the edge. Never use chemicals such as benzene and paint thinner to clean disc.

## **PROJECTION TELEVISION WARNING**

Still pictures or images may cause permanent picture tube damage or mark the phosphor of the CRT. Avoid repeated or extended use of video games on large-screen projection televisions.

## **SEGA DREAMCAST VIDEO GAME USE**

This GD-ROM can only be used with the Sega Dreamcast video game system. Do not attempt to play this GD-ROM on any other CD player; doing so may damage the headphones and/or speakers. This game is licensed for home play on the Sega Dreamcast video game system only. Unauthorized copying, reproduction, rental, public performance of this game is a violation of applicable laws. The characters and events portrayed in this game are purely fictional. Any similarity to other persons, living or dead, is purely coincidental.



# CONTENTS

<b>Loading .....</b>	<b>2</b>
<b>Introduction .....</b>	<b>4</b>
<b>Main menu .....</b>	<b>4</b>
<b>Starting Out .....</b>	<b>5</b>
<b>Options .....</b>	<b>6</b>
<b>Controls .....</b>	<b>8</b>
<b>Ring Display &amp; Meters .....</b>	<b>9</b>
<b>Game Modes .....</b>	<b>11</b>
<b>Create Mode .....</b>	<b>16</b>
<b>Some Moves .....</b>	<b>20</b>



# LOADING

1. Insert your ECW ANARCHY RULZ™ Sega Dreamcast™ Specific disc into your Sega Dreamcast console as described in the instruction manual.
2. Plug your Sega Dreamcast Controller into Controller Port A.

**Note: ECW ANARCHY RULZ is a 1- 4 player game\*. Before turning the Sega Dreamcast power ON, connect the controller or other peripheral equipment into the control ports of the Sega Dreamcast.**

3. Switch on the power to your Sega Dreamcast Unit.
4. Each saved game requires 2-96 blocks of memory. If you do not have a VMU or it does not have adequate blocks to save the game data, you will be alerted but may continue playing.

**While saving a game file, never turn OFF the Sega Dreamcast power, remove the memory card or disconnect the controller.**

**\*Purchase additional controllers (sold separately) to play with two or more people.**

**To return to the title screen at any point during game play, simultaneously press and hold the A, B, X, Y and START Buttons. This will cause the Sega Dreamcast to soft-reset the software and display the title screen.**

## SEGA DREAMCAST HARDWARE UNIT

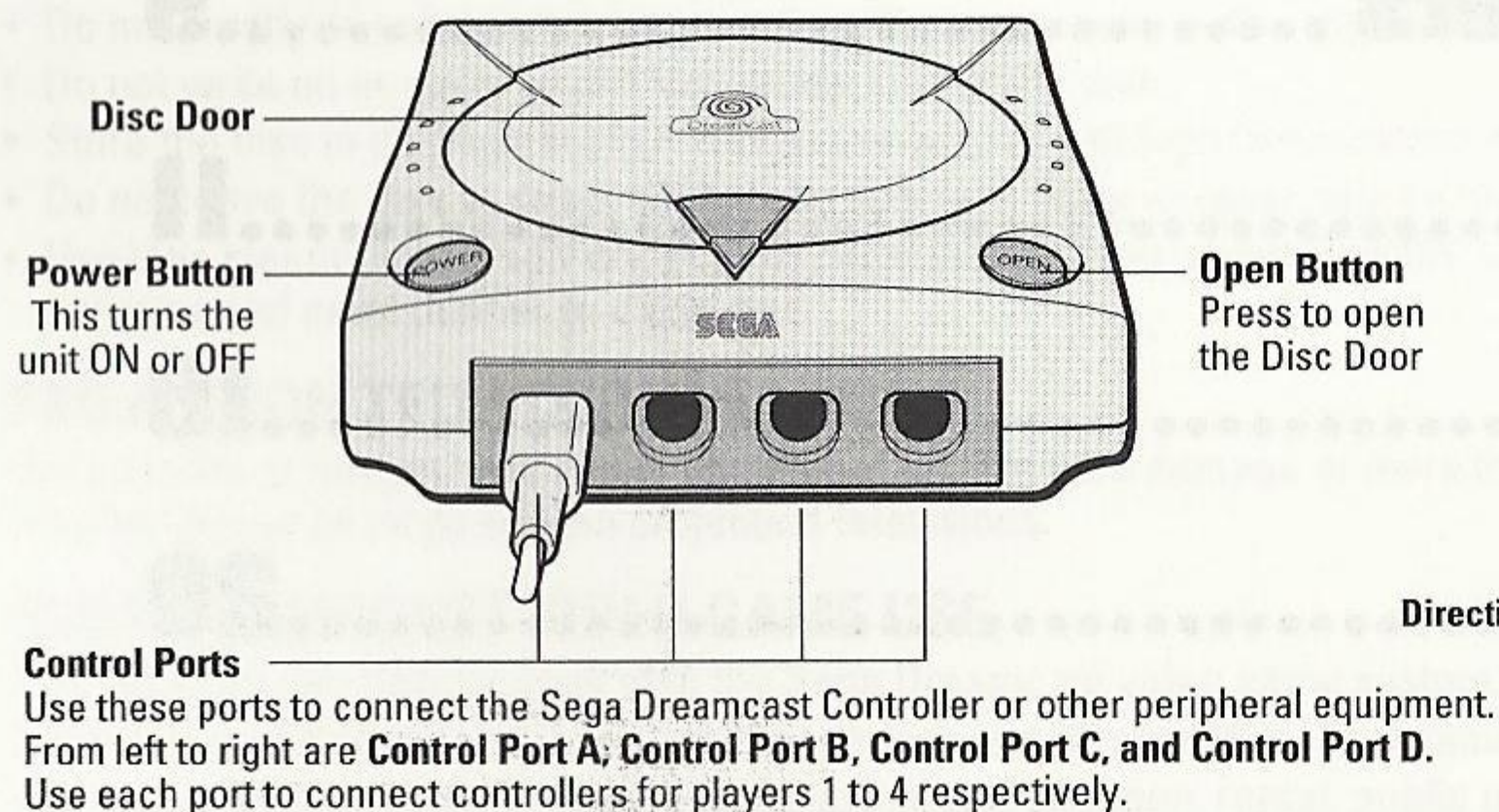

## SEGA DREAMCAST VISUAL MEMORY UNIT (VMU)

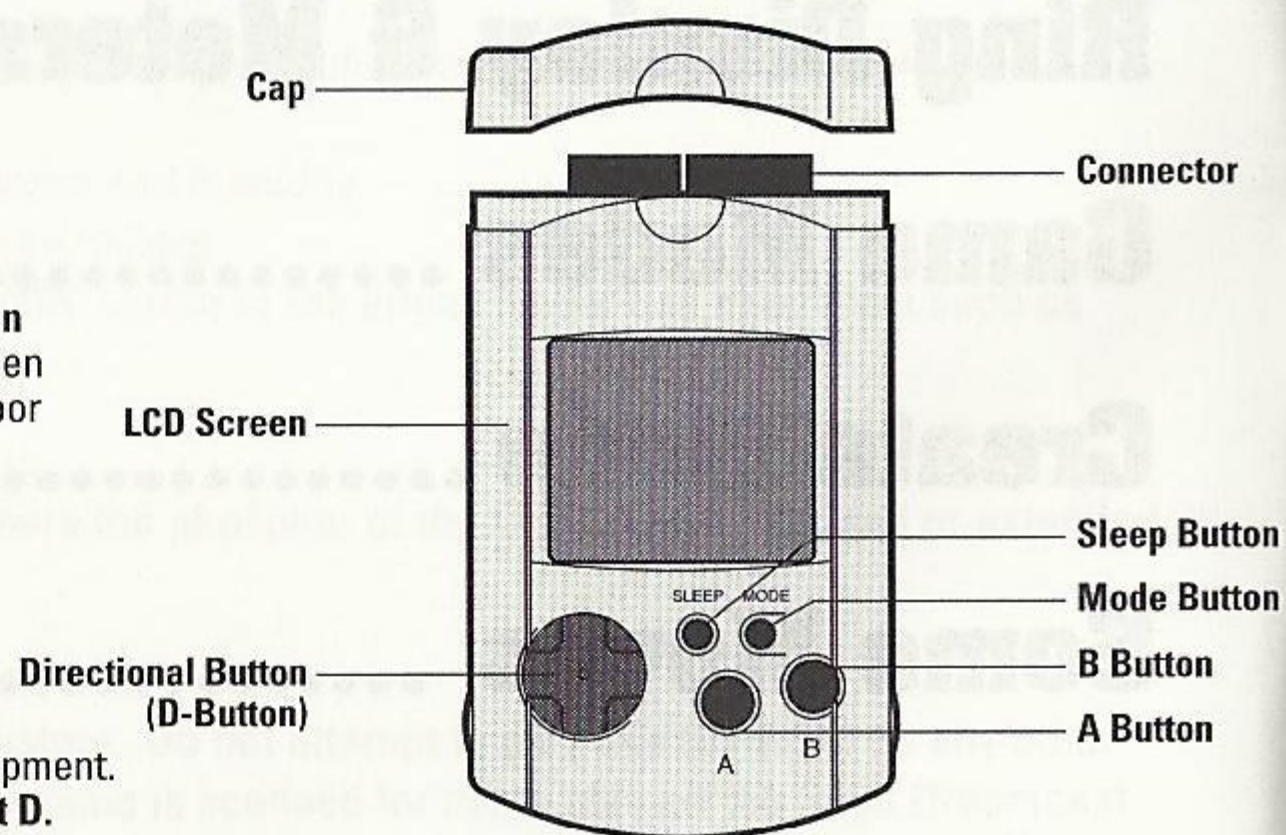

Never disconnect the VMU while performing a battle or exchanging data when connected to another VMU. Also note that leaving two VMU connected for a long period of time will considerably shorten the life of the batteries.



# SEGA DREAMCAST CONTROLLER

## Overhead View

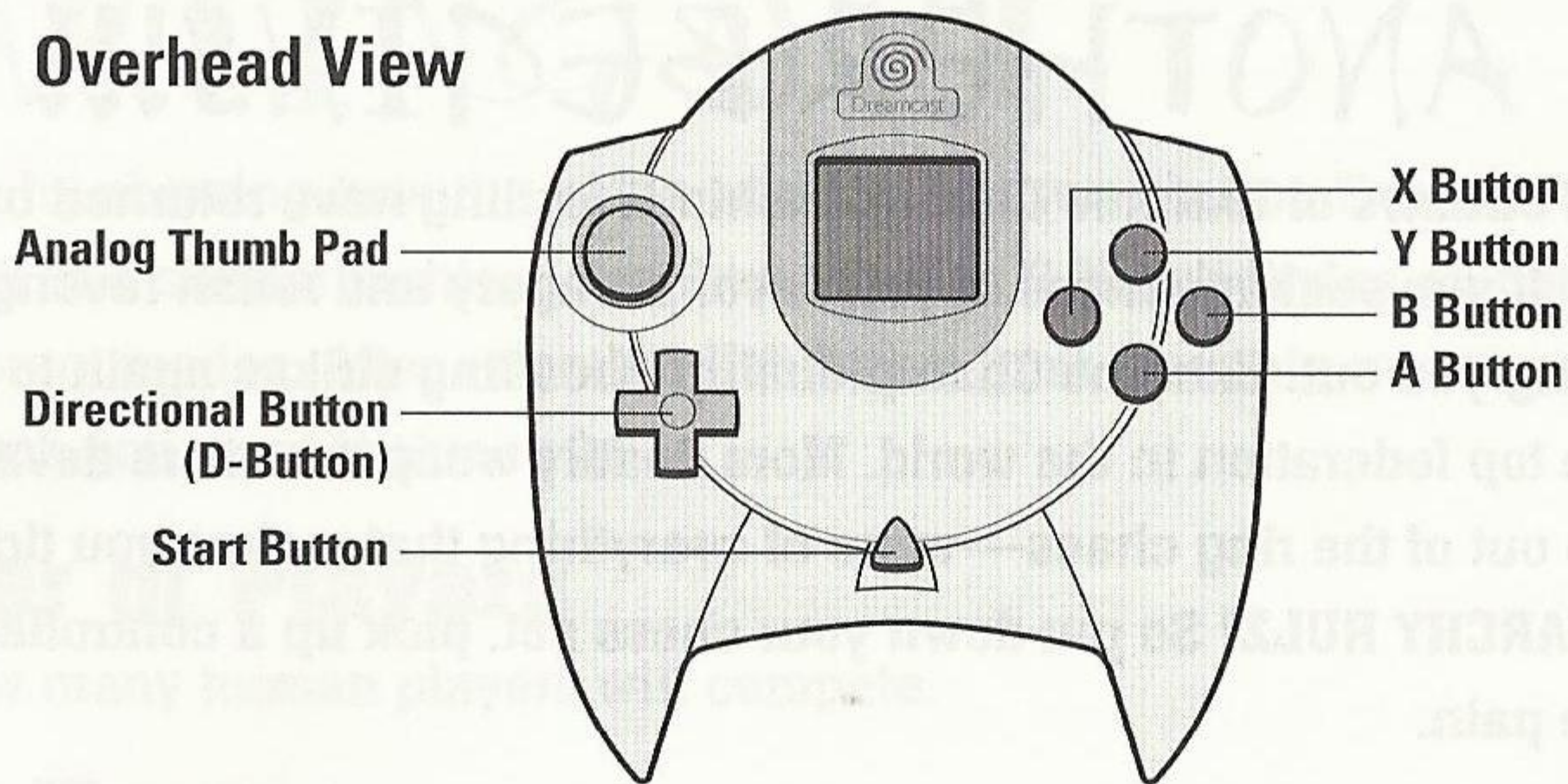

## Forward View

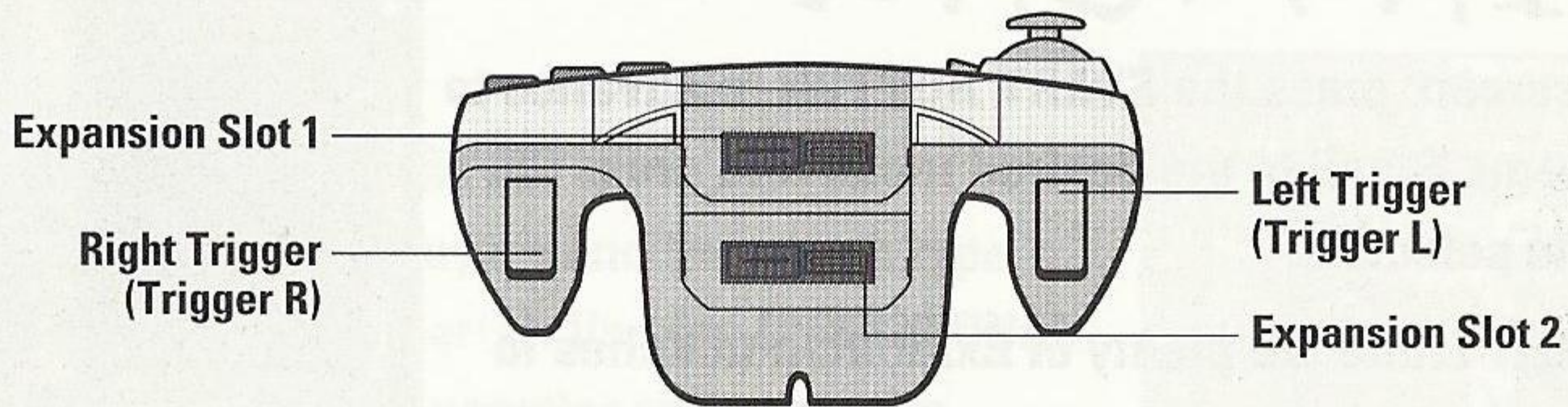

Never touch the Analog Thumb Pad or Triggers L/R while turning the Sega Dreamcast power ON. Doing so may disrupt the controller initialization procedure and result in malfunction.

If the Analog Thumb Pad or Triggers L/R are accidentally moved while turning the Sega Dreamcast power ON, immediately turn the power OFF and then ON again making sure not to touch the controller.



# WHEN ONE REIGN OF TERROR ENDS, ANOTHER BEGINS!!!

The underground outlaws of Extreme Championship Wrestling have returned bigger and badder than ever. If you seek madness, if you savor savagery and relish revenge, then this game is calling you out. Extreme Championship Wrestling strikes again to show and prove why it's the top federation in the world. More deadly weapons, more devastating maneuvers, more out of the ring chaos—more of everything that makes you tick! Once the bell rings, **ANARCHY RULZ!** So put down your chess set, pick up a controller and get ready to bring the pain.

## MAIN MENU

At the title screen, press the **START BUTTON** to advance to the main menu. Scroll to the desired mode and press the **A BUTTON** to select it.

**Exhibition:** There are plenty of Exhibition matches to choose from. Try 'em all!

**Career:** A lifetime's worth of glory in one intense season.

**Tournament:** Eight wrestlers compete in heated tournament play.

**Create:** Visit this loony laboratory and create your own wrestlers, pay-per-views and stables!

**Bio Room:** Stop into the bio room to view tons of fun facts about your favorite wrestlers.





**Utilities:** Set and save options, and save cheats.

# STARTING OUT

We'll begin by showing how the game works when you choose Exhibition mode. Other modes work in a similar fashion. See **Game Modes & Match Styles** on page 11 for details on the different modes. After selecting Exhibition from the main menu, you'll select the kind of match you want to thrash in.

## Number of Players

Choose how many human players will compete.

## Match Type

Choose which match you wish to maul in. See **Match Styles** for details on each type of match.

## Selecting Wrestlers

After choosing the number of players and the match type, you're ready to pick your grappler(s). Use the **DIRECTIONAL BUTTON** to scroll to the desired wrestler and press the **A BUTTON** to select, or press the Right Trigger to have the computer randomly select a wrestler. Depending on the type of match, you select the wrestler you want to control, those the computer will control, or have random ones assigned. In Career Mode, you pick one wrestler (two in Tag Career) to guide through an entire bloody season.

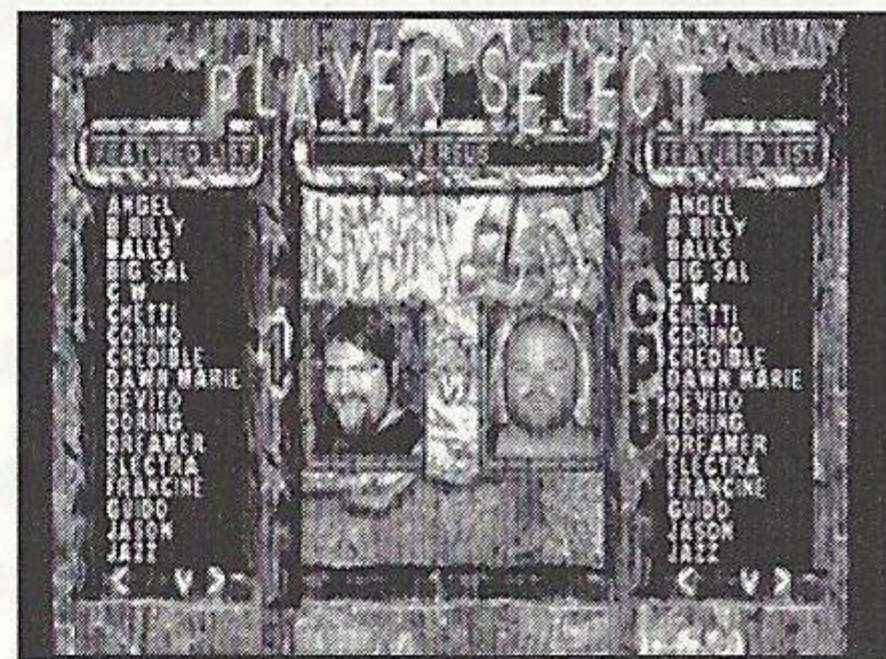

In all other modes, Player 1 selects CPU wrestlers. And don't forget, once you've created and saved a custom creature in **Create A Wrestler** mode (see page 16), you can load it for use in any game mode.



# OPTIONS

After selecting a match and wrestler(s), choose Start Game and let the begging begin at default settings, or set some options. The options available depend on the type of mode and match you select.

## MATCH OPTIONS

**None:** A regular match with no special settings or rules.

**Deathmatch:** Make weapons available during the selected match, and no count out!

**Cage Match:** Battle in a steel cage, and climb over the top to victory.

**Last Man Standing:** Once an opponent is knocked down, a counter counts down from 10. If the number reaches zero before the wrestler stands back up, you win!

**Streetfight:** This allows players to be pinned inside or outside of the ring.

**Barbed Wire:** Replace ordinary ring ropes with barbed wire!

**Dumpster Match:** Looks like someone forgot to take out the trash! To win you must throw your opponent in the dumpster.

**Table Match:** There are tables around the ring; put your opponent through them for some extreme action. No table cloth tricks here, just brutal brawling. Check please!

**Brimstone Match:** In this hellish match you have to toss your opponent over the ropes to finish him off.

**Rage in the Cage:** Civilization continues to decline in this roaring cage fest.

**Backlot Brawl:** Behind the scenes havoc not for the timid.



# WIN MODIFIERS

**Iron Man Match:** The winner is the player with the most pins within a given match length (time).

**I Quit Match:** A player can only win by forcing the opponent to submit.

**First Blood Match:** When ON (see Utilities, page 17), the winner is the player who causes the other to bleed first.

**Finisher Only:** You can only win by using your finishing move on your opponent.

**2 out of 3 Victories:** Meet the win conditions two out of three times to win the match.

# GAME OPTIONS

**Belt Challenge:** Choose to make this match a belt challenge (ON) or a regular match (OFF). This option is only available between human opponents and at least one of them has to have a belt.

**Simulation:** Let the computer play the match for you!

**Arena Type:** Choose the type of arena you wish to wrestle in.

**Time Limit:** Play with no time limit, or set the match length anywhere from one minute all the way up to an hour!

**TKO:** When ON, the match ends after any player has taken a specific amount of damage.

**Announcer:** Play with or without the announcer's commentary.

**Handicapping:** Set the degree of handicapping to be from 10 to 100% of a wrestler's health. When set to 10%, your opponent's health will already be in the red when the match begins! Available only in Exhibition matches.



# CONTROLS

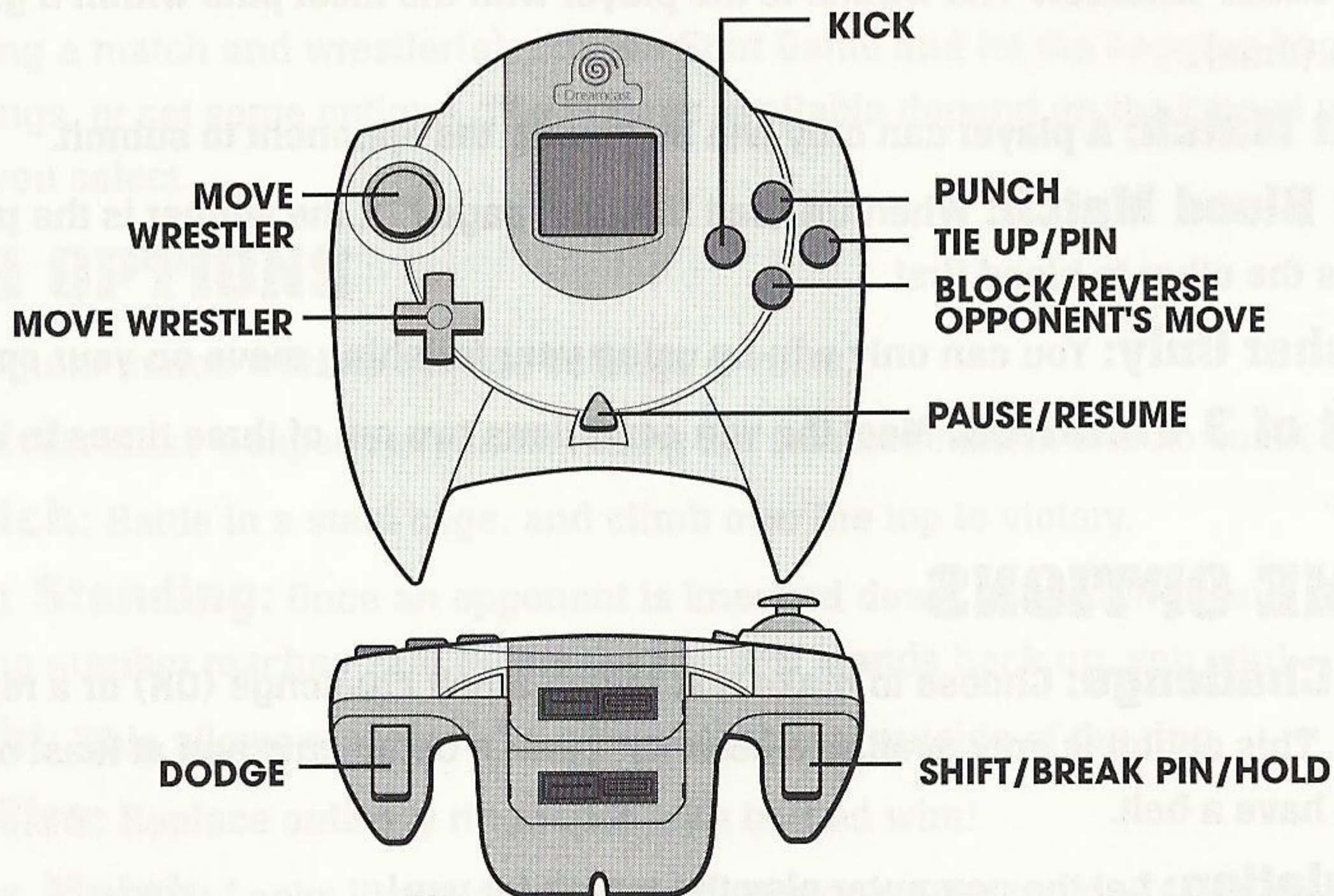

Dodge	RIGHT TRIGGER
Run	HOLD RIGHT TRIGGER + D PAD
Change Focus	L TRIGGER + R TRIGGER (or ANALOG)
Pick Up/ Drop Weapon	LEFT TRIGGER + A Button
Tag	LEFT TRIGGER + B Button
Call In Tag	LEFT TRIGGER + X Button
2 on 1 Move	CORRECT POSITION + B Button
Taunt	X Button + B Button
Break Pin/Hold	LEFT TRIGGER
Swap Control	LEFT TRIGGER + Y Button
Shift	LEFT TRIGGER
Mercy	RIGHT TRIGGER
Baseball Slide	HOLD RIGHT TRIGGER + D PAD + LEFT TRIGGER



# RING DISPLAY + METERS

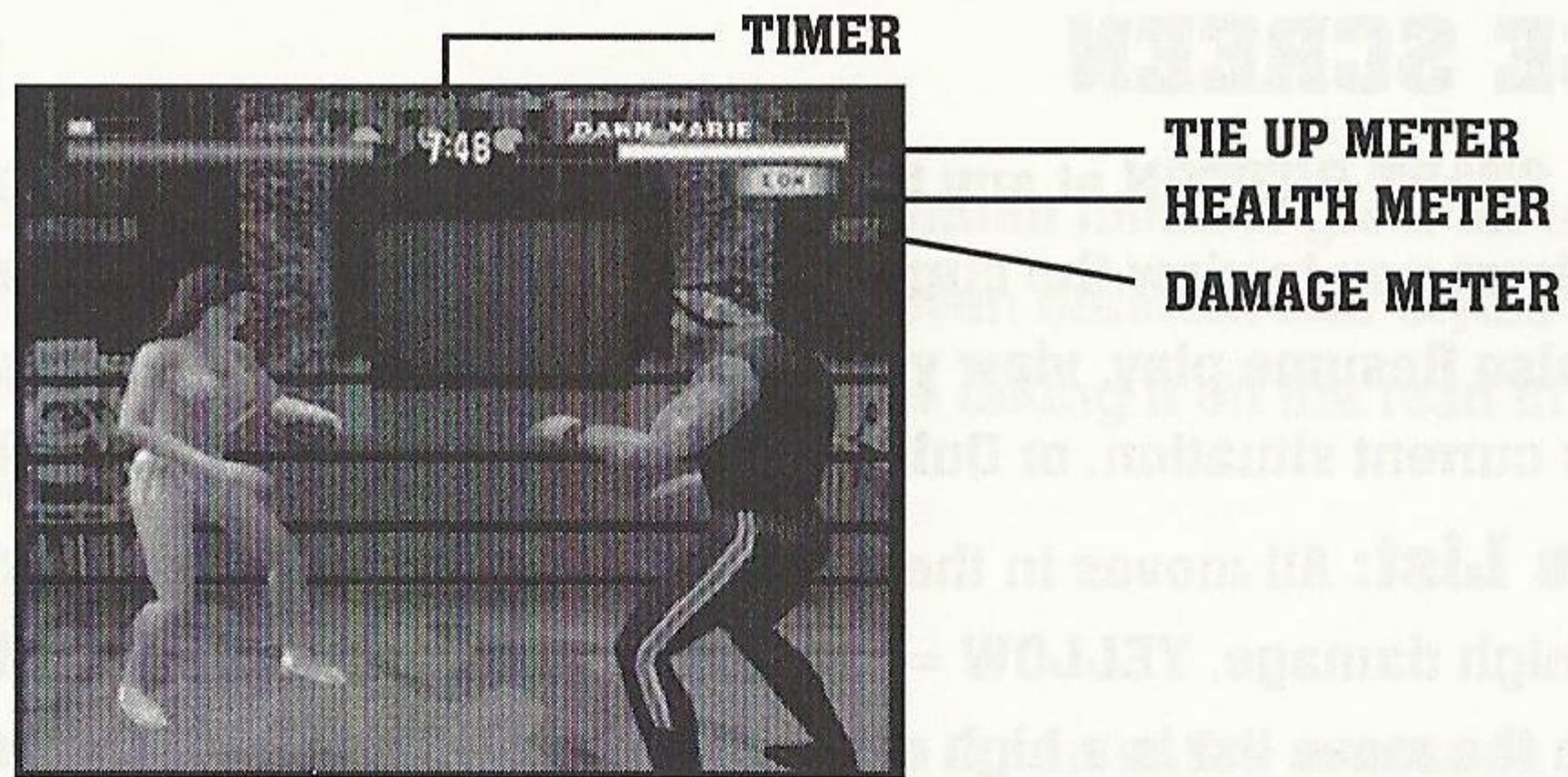

**Timer:** Look here to see how much time is left in the match, or, in a Battle Royal Elimination match, how many seconds left in the countdown.

**Tie Up Meter:** This meter measures your advantage in a tie up. Start off with ready moves like punches and kicks until the tie up meter appears. As a wrestler scores hits, the box beside the wrestler name changes from green to yellow to red. Green means you can get off low damage tie up moves, yellow equals medium and red equals high damage moves. The **DIRECTIONAL BUTTON** plus the Kick **BUTTON** performs low damage Tie-up moves. The **DIRECTIONAL BUTTON** plus the Punch **BUTTON** performs medium damage Tie-up moves, and the **DIRECTIONAL BUTTON** plus the Tie-up **BUTTON** performs High damage tie-up moves. **Warning:** Trying to perform moves that are higher damage than you have the advantage for will perform weak, easily reversible moves.

**Health Meter:** The health meter shows each wrestler's condition, and ranges from green (top condition) to orange (beginning to weaken) to red (danger—look out for pins and finishing moves).



**Damage Meter:** The damage meter shows the type of damage inflicted on your opponent. The meter range is Low, Medium, High and Extreme.

## PAUSE SCREEN

Press the **START BUTTON** at any time during a game to bring up the Pause menu. This screen allows you to view the current match type, win modifier (if any) and win location. You can also Resume play, view your Move List to see all the moves and controls for your wrestler's current situation, or Quit the current match and return to the main menu.

**Moves List:** All moves in the move list are color coded by the damage they do.

**RED** = high damage, **YELLOW** = medium damage, **GREEN** = low. For example: Each red move in the move list is a high damage move, yellow does medium damage, and green does low damage. High damage (red) ready moves can only be performed when the opponent is dizzy and high damage tieup moves can only be performed when using the red tieup advantage. All other situations for high, medium, and low damage can be performed at anytime.

## Match Statistics

At the end of each match, the computer helpfully totes up a wide array of useful statistics; so many that it takes two screens to view all of them. Check out how often you use which moves, your submission attempts, how long the match was—we tell you everything but what you ate!

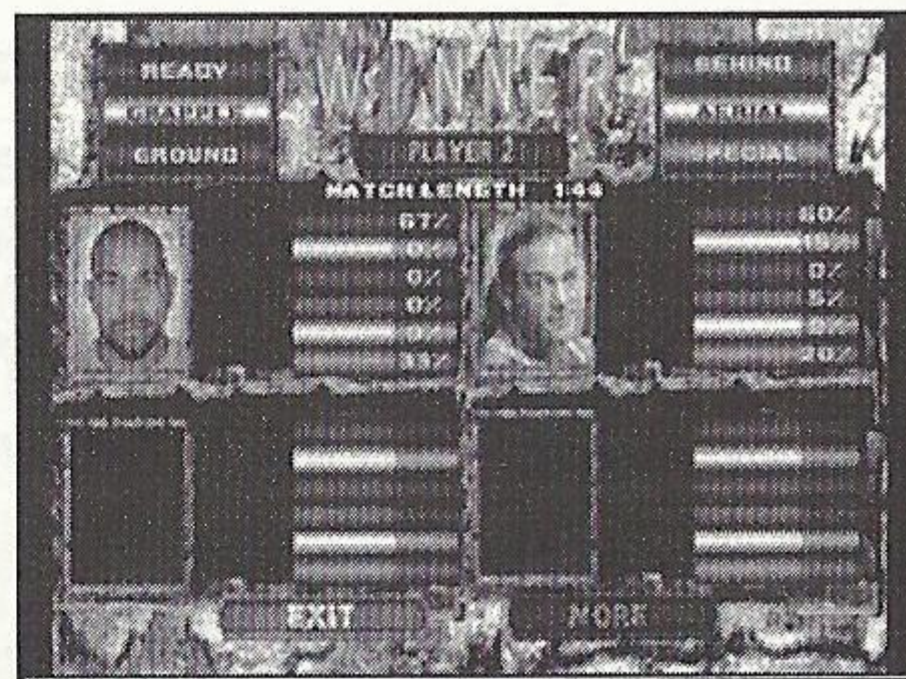



# GAME MODES

## EXHIBITION

An exhibition match is a single match of any type. Exhibition mode is great for trying different wrestlers, different moves, different matches, even different hair styles (using a created wrestler)! This is a great place to practice before taking it on the road in Career mode. Exhibition matches don't count in the standings.

## CAREER MODE

Once you've got some skills, you'll be eager to test them for an entire season in Career mode. This is the road to the championship, and it's paved with the pitiful wailing of wilted wannabes who thought they had what it takes. Only the elite few make it all the way to the top. Are you ready for the ultimate test?

You begin at the bottom and battle up the ladder to the pinnacle of the profession, the ECW World Heavyweight Championship. There are several levels of titles; success at one only gives you the right to fight for another while you defend your current title, and there's always some ambitious @\$% trying to knock you down and take your crown. It's a long road from rags to riches. You'll need all the luck, skill and cold-blooded determination you can muster to avoid riding the wuss-wagon home while someone better waves from the express to success. There are three ways to play in career mode:

**Standard:** You guide one wrestler through an entire season of gouging, grappling and getting even.

**Tag Team:** Take two tag team partners to the Tag Team Championship—if you can!

**Stable:** There's more madness when you guide a gang to the top of the heap.



# Career Matches

You have a schedule of matches each week as you tour the country. Friday's matches are televised on TV, and there are special Pay-Per-View matches too. There are three championship levels: World Television Championship, World Heavyweight Championship, and World Tag Team Championship.

## TOURNAMENT

Why not start at the top? The Tournament is a series of regular one on one Vs. matches. Each time you win, you advance to the next tier. When there's no one left to beat, you're the winner! Up to eight human players can compete in a tournament. Player 1 selects the wrestlers, then all players take turns, using controllers 1 and 2. If you like, you can simulate tournament games, choosing to view the simulation or just view the winners.

## MATCH STYLES

Most matches can be played in two ways: normal and elimination. In normal matches, you win when you beat your first opponent. An elimination match requires you to beat all your opponents. Elimination matches are indicated by an asterisk (\*) on the match select menu.

## Normal matches

**Vs.:** A one on one battle. Each player selects a wrestler. The match continues until the rules set up by the player are satisfied.

**Tag Team:** In tag team wrestling, two teams of two wrestlers each compete one on one, with only two "legal" wrestlers in the ring at a time. A wrestler in the ring tags his teammate to come in and take his place. An illegal wrestler can enter the ring for a five second count, but then must exit and return to his team corner.



**Tornado:** Tornado matches feature four wrestlers in the ring at once in bracing two on two action. The match ends when both wrestlers on a team have been eliminated. When a single wrestler is eliminated, it's two on one inside the ring, but beware: The eliminated wrestler can continue to wrestle outside the ring.

**One on Two:** It's not fair, but it's plenty of fun. One wrestler takes on two opponents at once, and must pin one in order to prevail.

**One on Three:** This is really tough! You'd better be among the best if you hope to avoid a beating with three wrestlers ganging up on you at once!

**Lumberjack:** Two wrestlers battle it out, and they better keep their thing in the ring, because there are two CPU wrestlers waiting at ringside, ready to hand a beating to anyone who (willingly or not!) leaves the ring.

**Three Way Dance:** Three wrestlers compete until one pins or forces another to submit. It's every madman for himself!

**Four Way Dance:** Four wrestlers compete until one submits or is pinned.

**Battle Royal:** There are four wrestlers in the ring at all times, each trying to be the last one left. You can't leave the ring, and there are no pins, no submissions and no count outs. Eliminate your foes by throwing them over the ropes!

**Hate Match:** OK, hate's a pretty strong word, but you'll love the incredible action in a hate match, as wrestler after wrestler comes into the ring to serve up some severe beatings. This is the toughest match there is, and small wonder: If you thought one on three was hard, try going one against 12!

**Team Rumble:** Pick some team members, then get ready to rumble as the ring becomes a furious free for all match.

**Stable Match:** Four teams of four wrestlers test their mat acumen in a fierce



free for all. As soon as one wrestler is defeated, another comes in. The last wrestler on each team can battle any opponents outside the ring.

## **Elimination Matches**

**Vs.:** In this mode, the two wrestlers start off in the ring, but one opponent is allowed to select a four man team. The player with only one wrestler must defeat all the other wrestlers! In a 1 player Elimination Vs. match, you fight to eliminate one CPU wrestler, until another comes in. You win if you can defeat all four—one by one!

**Tag Team:** One Tag Team versus two Tag Teams! Tough stuff!

**Tornado:** One team of two takes on two teams of two with Tornado rules. That means that all four wrestlers are legal in the ring at all times!

**One on Two:** It's double the danger as you take on two wrestlers intent on beating you into submission. Twice the trouble and half a chance to win!

**One on Three:** Try taking on three wrestlers at once. It ain't easy, brother. Battle to be the last one left.

**Eight Man Tag:** Let's jack up the team numbers and see what happens! It can't be pretty.

**Battle Royal:** The parade of punishment features four wrestlers in the ring at all times. The winner is the last man in the ring. Action continues until every wrestler has been in the ring. See Normal Battle Royal.

**Three Way Dance:** A free-for-all with three wrestlers. Once two have been eliminated, the one left is the winner.

**Four Way Dance:** It's cruel, but not at all unusual as four wrestlers grapple in an every-man-for himself contest. Thrive? You'll be lucky to survive!



FIRST  
CLASS  
POSTAGE  
HERE

**REGISTER  
ONLINE  
AND WIN!**

*see back for details*



REGISTER ONLINE AT [www.acclaim.com](http://www.acclaim.com)  
FCM AND/OR BY DULZIM FOR SEGA DREAMCAST™ GAME SYSTEM



t.

he

her



free for  
each  
**Elin**

**Vs.:**

select

wrestl

until a

**Tag**

**Torn**

that a

**One**

you in

**One**

the la

**Eigh**

pretty

**Battl**

times

been

**Thre**

elimir

**Fou**

From: \_\_\_\_\_

\_\_\_\_\_

\_\_\_\_\_

Check here if this is a new address.



WARRANTY REGISTRATION  
ACCLAIM ENTERTAINMENT INC  
ONE ACCLAIM PLAZA  
GLEN COVE NY 11542





## Co-Op Matches:

Take yourself and a teammate through the mighty co-op matches.

### 2 players

**Co-op Tag Team:** Tag yourself and a friend up against two computer controlled opponents. One user will be the illegal wrestler (standing on the apron) that can perform a sneak attack within the 5-second counter. This is a great time for a double team move. (See Tag Team)

**Co-op Tornado:** You and a teammate taking on two computer opponents with all four wrestlers in the ring.

**Co-op 2 on 1:** You and a teammate beat the \$\*&% out of one computer opponent. This is where you can beef up your 2 on 1 skills.

**Co-op 3 on 1:** Yet another stomp on the computer, but you are given one more teammate which is also computer controlled to help out with the master beating to the opponent.

**Co-op 8 Man Tag** Try a four on four tag fiesta!

**Co-op Rumble:** Use a teammate in this fierce match to team up on the many other cpu opponents.

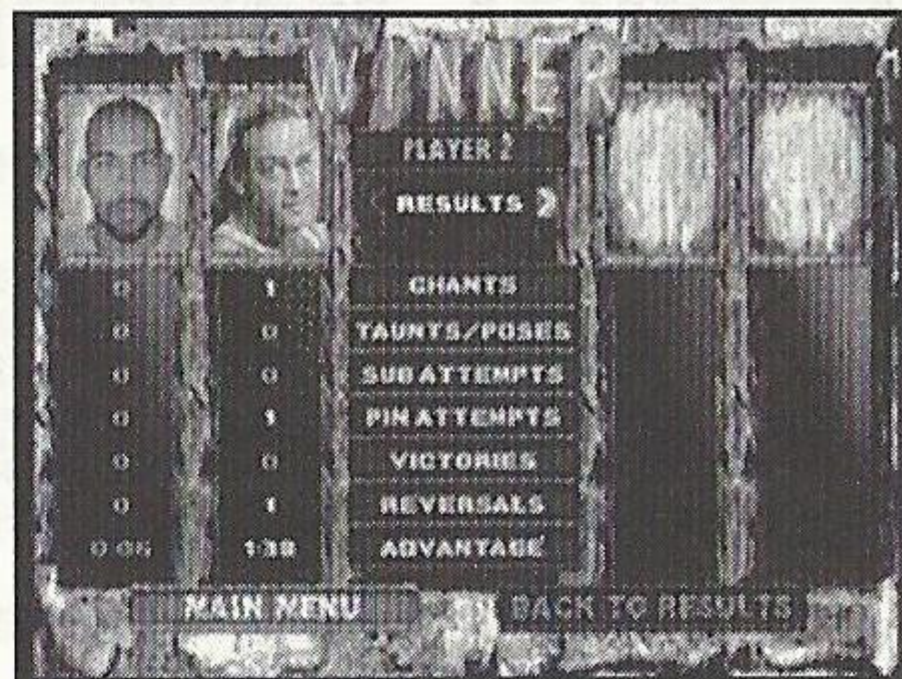



## 3 players

**Co-op 3 on 1:** All three users up against the solo cpu for the pummeling of his life.

## SPECIAL MATCHES

You can perk up some matches by turning on such options as Deathmatch, Last Man Standing, Barbed Wire or Table Match, just to name a few. These matches can be vastly entertaining or tremendously troubling, sometimes both. Try a couple. We think you'll find that fighting in a Dumpster is all you hoped for and more.

# CREATE MODE

Create mode lets you build custom wrestlers, pay-per-view events and stables and save them to your MEMORY CARD for future use.

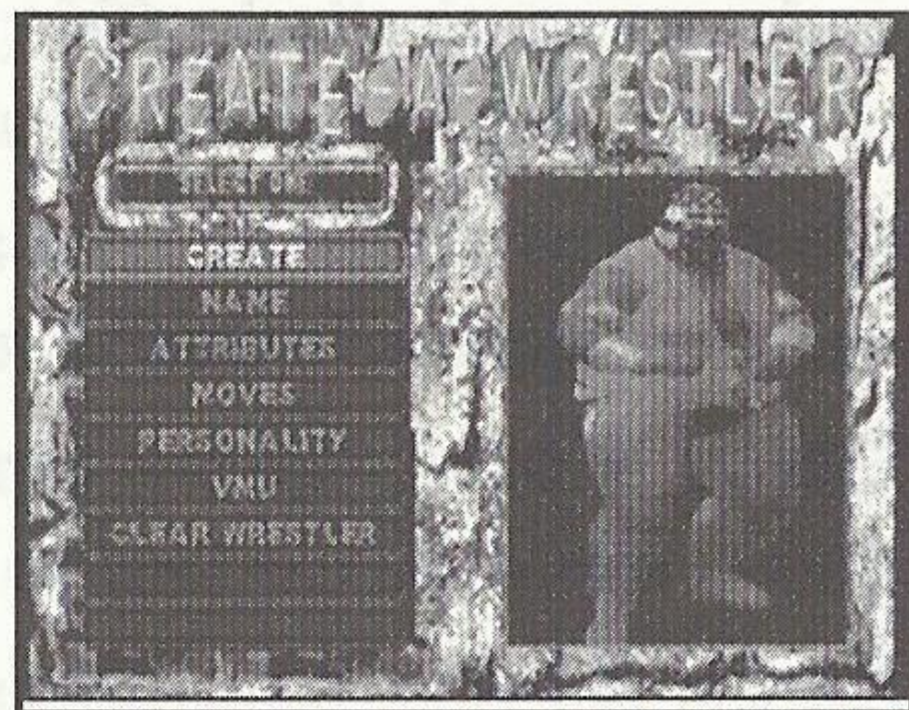

## WRESTLER

Select **Wrestler** to create custom grapplers that can be imported into any game mode. You can assign all manner of attributes, including the wrestler's name, look, ability, and personality.

**Create:** Select Create to build your grappler. This will bring you to a sub menu with these choices:

**Body:** Select a body type: Male, female, fat or thin, in any color—it's up to you!

**Head:** Even Frankenstein's monster had a head. Shouldn't yours?

**Upper:** Arrange the top half for maximum intimidation or maximum laughs. Outfits, accessories and more are at your finger tips.



**Lower:** Just like Upper options, but these pertain to the lower body.

**Text:** Put some rude text on your custom creature's clothing.

**Random:** Let the computer create an outrage for you!

**Clear Clothing:** Back to the drawing board, Rupert!

### **Changing colors:**

Many create options feature color adjustment fields. Press the **Y BUTTON** to access the color function, then press **DIRECTIONAL BUTTON UP** or **DOWN** to highlight the color, hue or saturation fields, and **DIRECTIONAL BUTTON LEFT** or **RIGHT** to adjust the sliders.

When you're satisfied, press the **B BUTTON** again to return control to main window.

**Name:** Give your new wrestler a first and last name, even an alias.

**Attributes:** Adjust the sliders to increase or decrease your wrestlers degrees of six important attributes, up to a total of 36 attribute points.

**Moves:** Mix and match the best moves in the ECW. There's one that's just right for every situation!

**Personality:** Give your creature a strong identity, including crowd reaction, fighting style, theme song and more!

**Memory Card:** Access your **MEMORY CARD** to save and load creation data.

**Reset:** Clear your created wrestler and start all over again.



# **PAY-PER-VIEW**

At last, you're in charge of setting up the kind of spectacular Pay-Per-View you want to see! You need a **MEMORY CARD** to create and play a Pay-Per-View, so if you don't have one, you better get one!

**Name Event:** Give your sensational event a catchy title.

**Select Matches:** You can choose up to eight fear-filled matches to create a well-rounded raunch fest. Simply move the highlight to a match number, choose an exhibition or tournament style match, then select your match type and wrestlers as usual. Repeat until you have the Pay-Per-View of your dreams.

**Edit A Stadium:** Choose a stadium to rock and make it look just the way you like. Who says decorating is for sissies?

**Load PPV:** Load and play a previously saved Pay-Per-View from your **MEMORY CARD**.

**Save PPV:** Save your current Pay-Per-View progress and settings.

**Clear PPV:** Reset the Pay-Per-View.

**Start PPV:** Begin your xtreme extravaganza!

# **STABLE**

The Stable is a completely cool creation feature! You create the stable and then enter into a stable career with your own theme music, name, and icon. You can select four different wrestlers (featured, jobber, or created) to be on the same team for a Stable Match (4 wrestlers). You name the stable team, pick the theme music and team icon, then get ready for some serious stable action!



# BIO ROOM

Visit the Bio Room to learn all about the top ECW talent in Anarchy Rulz, and more! You'll find each wrestler listed alphabetically, as well as the jobbers and any wrestlers you've created and saved. Select a wrestler and press the A BUTTON. You'll see a new screen

featuring that wrestler's portrait, personal stats (including finishing move and trademark move), any titles the wrestler has earned, and rankings in all the important categories. This is a dandy tool for comparing wrestlers.

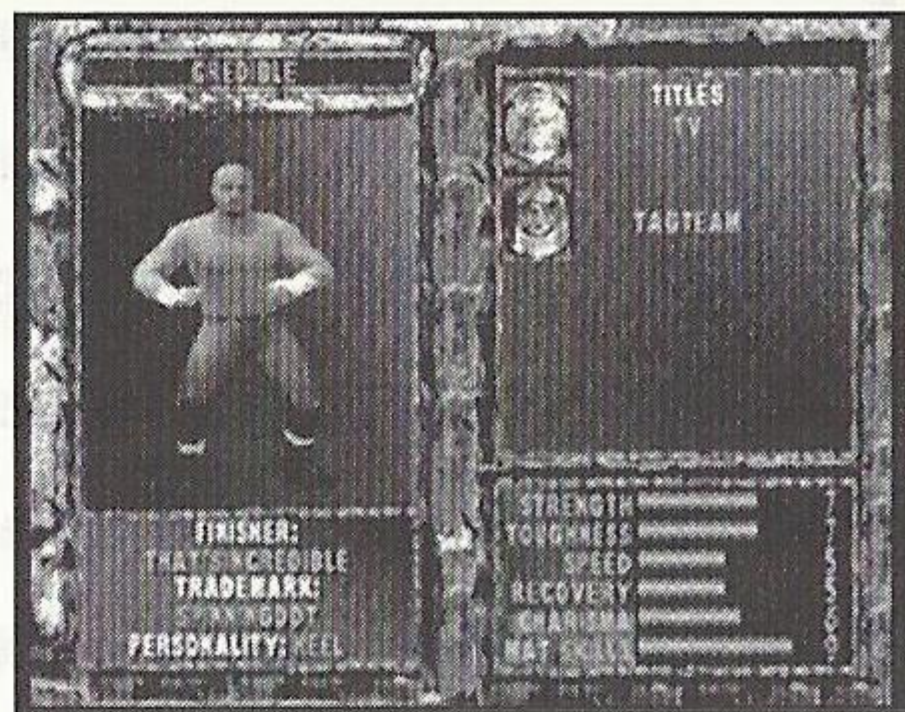

# UTILITIES

**Cheat Menu:** Once you've earned some cheats (special characters and effects hidden in the game), you can select characters and choose to turn the effects on or off.

**Save Options:** If you have a MEMORY CARD inserted, you can save your option settings.

**Difficulty:** Play at Easy, Medium or Hard skill settings.

**Intros:** Play with the notorious ECW ring intros ON or OFF.

**Recovery:** Wrestlers can regain health during a match (ON) or not (OFF).

**Stereo:** If you have two ears and two speakers, you may prefer stereo to mono.

**FX Volume:** Adjust the sound effects volume.

**Music Volume:** Adjust the music volume.





**Language:** Choose between language that's mature or for Everyone.

**Name Meter:** Play with the name meter display ON or OFF or acting as a health meter.

**Damage Meter:** Turn the damage meter ON or OFF.

**Tie Up Meter:** Turn the tie up meter ON or OFF.

**Health Meter:** Turn the health meter ON or OFF.

**Blocking:** Turn blocking ON or OFF for an outrageous change.

**Blood:** Play with realistic blood or bore yourself with none.

## Some Moves

HERE ARE A FEW MANIC MOVES TO GET YOU STARTED. THERE ARE MANY, MANY MORE, BUT YOU'LL HAVE TO PLAY PLENTY TO LEARN THEM!

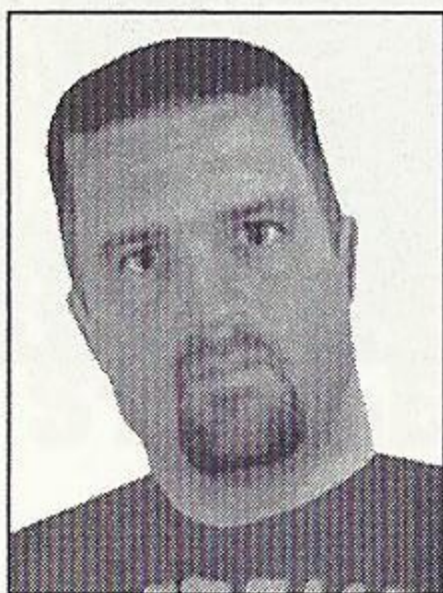

## Tommy Dreamer

**Type of Move**

Tie-up Move

**Finisher**

Dreamer DDT

**Move Set**

up or down, tie-up





# Rob Van Dam

**Type of Move**

Turnbuckle Move; Opponent on Ground

**Finisher**

5 Star Frog Splash

**Move Set**

kick & punch

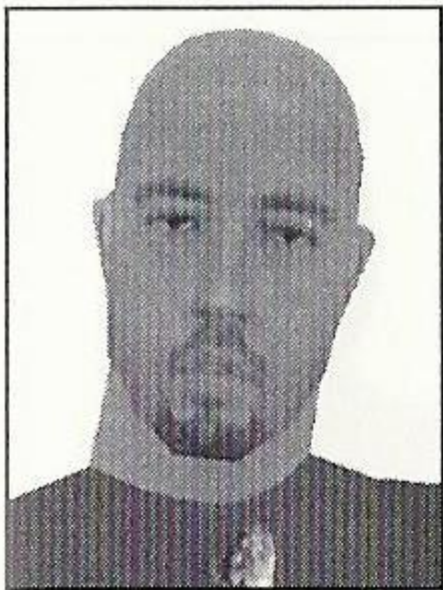

# Justin Credible

**Type of Move**

Tie-up Move

**Finisher**

That's Incredible

**Move Set**

up or down, tie-up



# Jerry Lynn

**Type of Move**

Ready Move

**Finisher**

Cradle Piledriver

**Move Set**

left or right, tie-up





# New Jack

**Type of Move**

Turnbuckle Move; Opponent on Ground

**Finisher**

187

**Move Set**

kick & punch

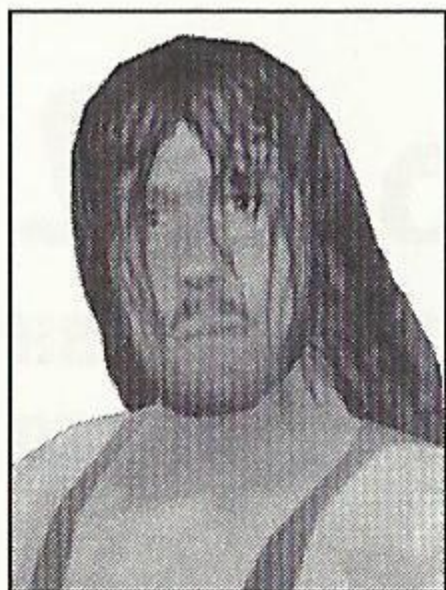

# Rhino

**Type of Move**

Tie-up Move

**Finisher**

Sitout Piledriver

**Move Set**

up or down, tie-up

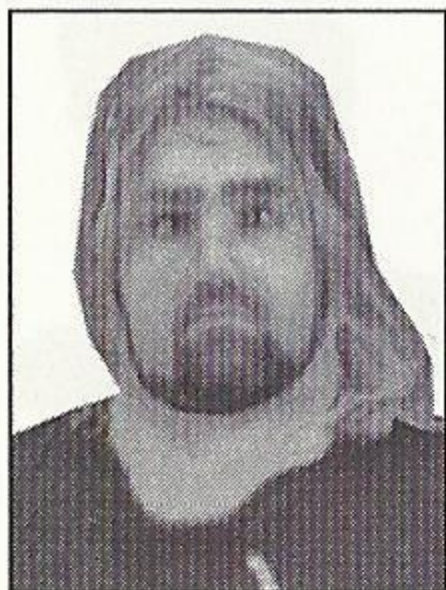

# Balls Mahoney

**Type of Move**

Ready Move

**Finisher**

Nutcracker Suite

**Move Set**

left or right, tie-up





## Super Crazy

**Type of Move**

Corner Move; Opponent on Ground

**Finisher**

Three Moonsaults

**Move Set**

left, right, punch

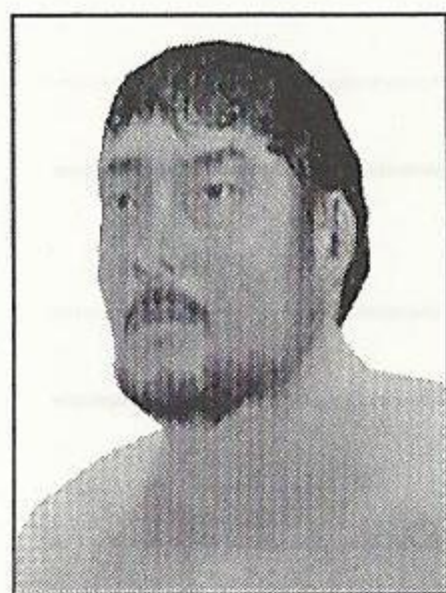

## Tajiri

**Type of Move**

Tie-up Move

**Finisher**

Hanging Brainbuster

**Move Set**

left or right, tie-up

## Hints + Tips

- During an Exhibition match with any wrestler, press the **START BUTTON** to see his move list. All moves that the wrestler can do from the given situation are displayed and color coded. Green for Low damage, Yellow for Medium, and Red for High.
- If you want to do the big bad power moves, you'll need to get your Tie-Up meter in the Red and then Tie-Up your opponent by pressing the **B BUTTON**. From there, you can pull off killer moves that will make the audience cheer.
- When your wrestler's name flashes, it means that you have won the support of the crowd thanks to your excellent performance. This will give you a rush and let you do more damaging moves. Conversely, don't just pull the same move off over and over or the crowd won't like it and your performance will suffer.



For the hottest hints and codes  
on **ACCLAIM** titles:

Please call **1-900-407-TIPS (8477)**

The cost of the call is \$.95 per minute. You must be 18 or have parental permission and have a touch-tone phone.

# Notes







# Notes

For the hottest hints and codes  
on ACCUPLAC titles,  
Please call 1-900-407-TIPS (8472)

Notes

The cost of the call is \$ .95 per minute. You must be 18 or have parental

Notes



The Album 8-22-00

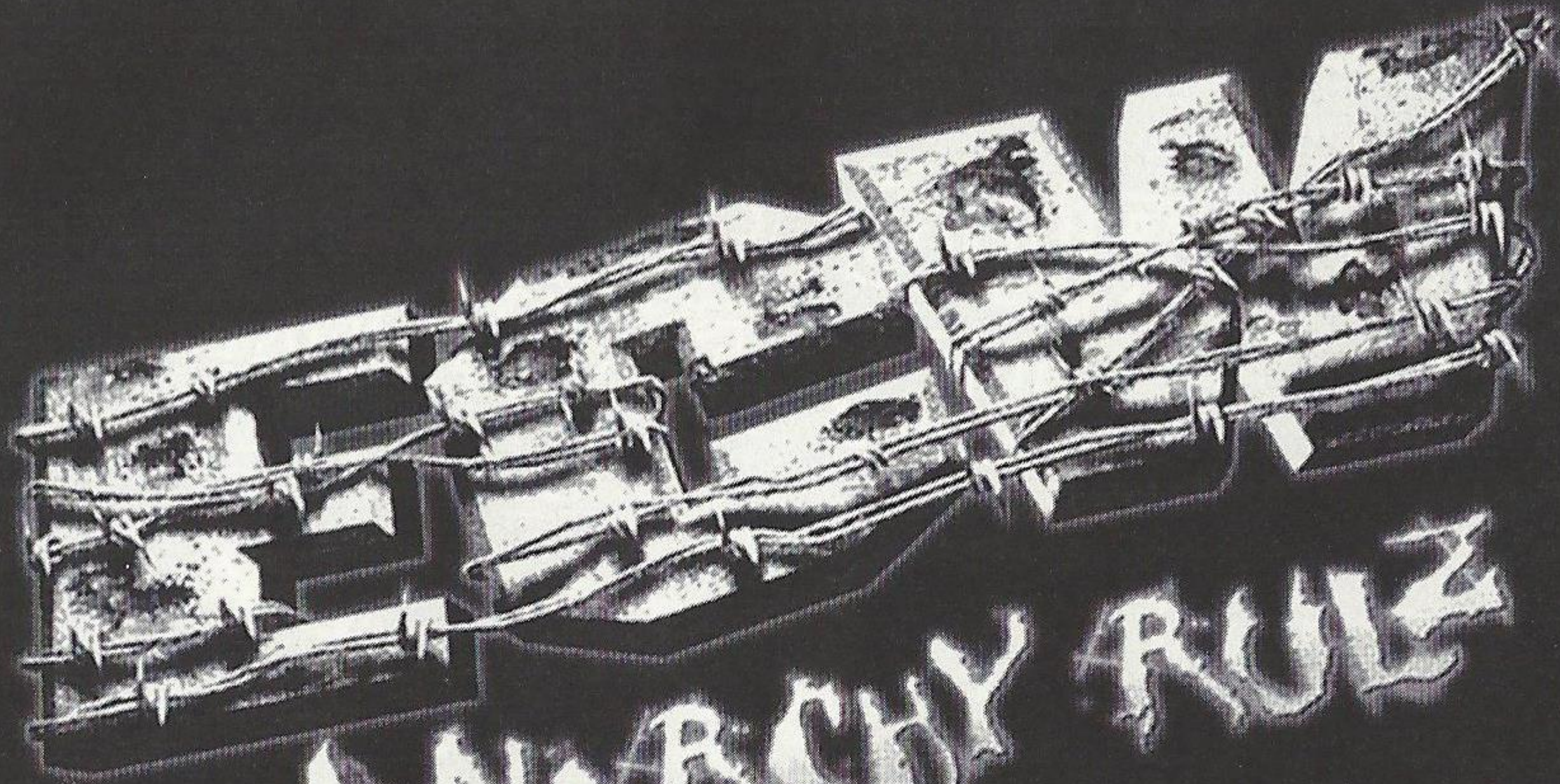

A NARCOY RULZ

Hard Hitting!  
Hardcore!





**AVAILABLE NOW ON VHS & DVD**

**IT'S TIME TO  
GET EXTREME!**

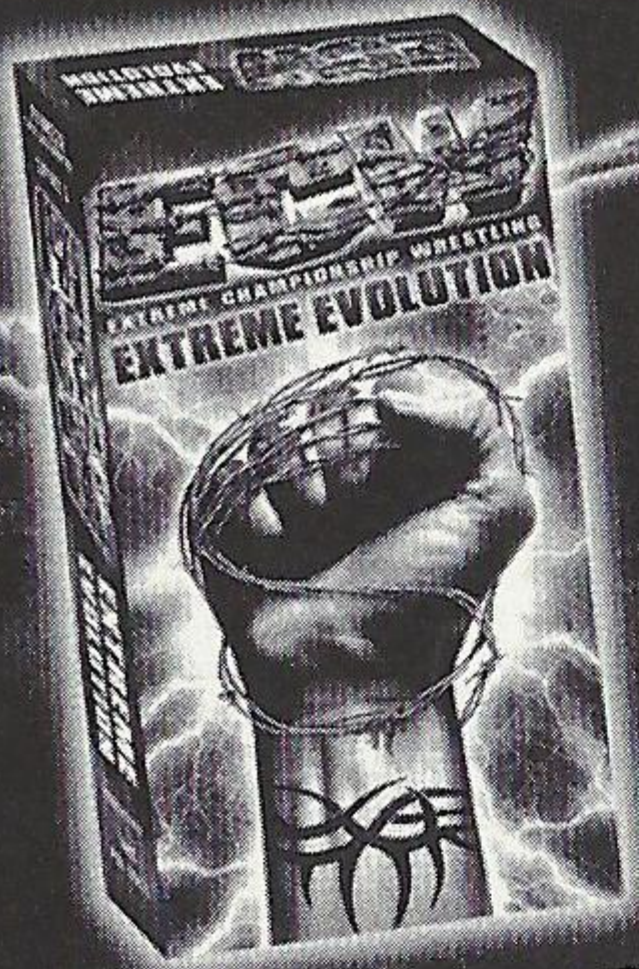

**CENSORED AND  
UNCENSORED**

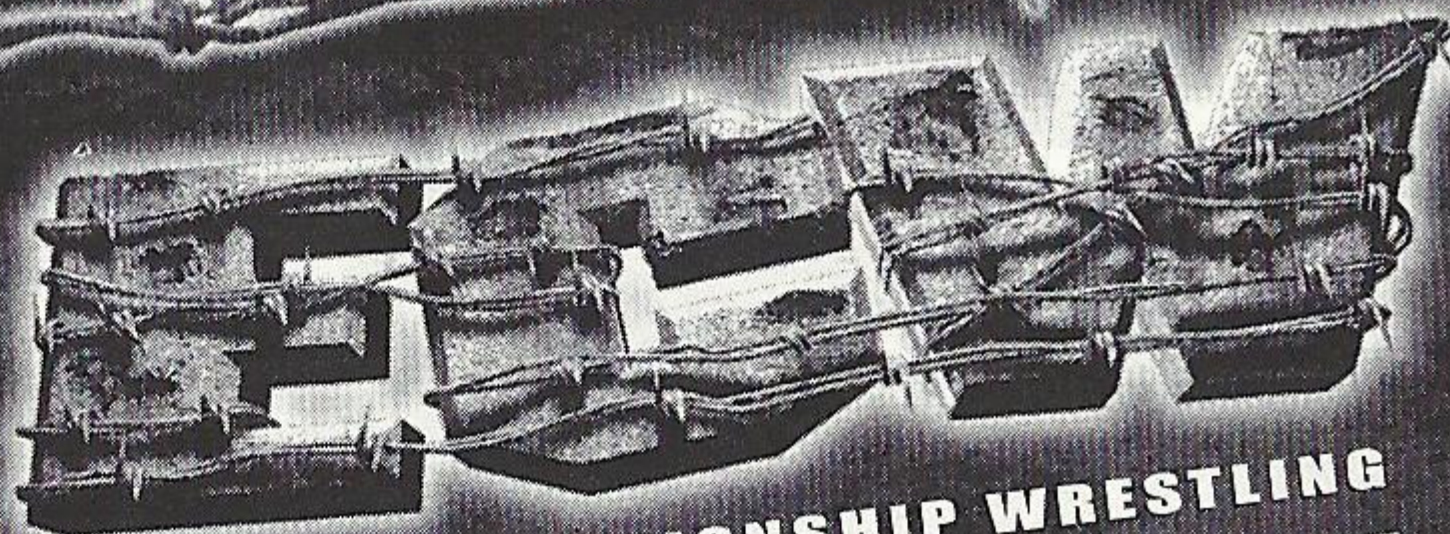

**EXTREME CHAMPIONSHIP WRESTLING  
EXTREME EVOLUTION**

*Contains Graphic Title Matches  
Never-Before-Released on Video Including  
the infamous Raven vs. Sandman  
BARBED WIRE match!*

[www.ecwwrestling.com](http://www.ecwwrestling.com)

[www.pioneer-ent.com](http://www.pioneer-ent.com)

© MM HHG Corporation. Artwork and Design ©MM Pioneer. All rights reserved. For sale or rental in the United States and Canada.

**PIONEER  
ENTERTAINMENT**



## ACCLAIM® LIMITED WARRANTY

ACCLAIM warrants to the original purchaser only of this ACCLAIM software product that the medium on which this software program is recorded is free from defects in materials and workmanship for a period of ninety (90) days from the date of purchase. This ACCLAIM software program is sold "as is," without express or implied warranty of any kind, and ACCLAIM is not liable for any losses or damages of any kind resulting from use of this program. ACCLAIM agrees for a period of ninety (90) days to either repair or replace, at its option, free of charge, any ACCLAIM software product, postage paid, with proof of date of purchase, at its Factory Service Center. Replacement of the software product, free of charge to the original purchaser (except for the cost of returning the software product) is the full extent of our liability.

This warranty is not applicable to normal wear and tear. This warranty shall not be applicable and shall be void if the defect in the ACCLAIM software product has arisen through abuse, unreasonable use, mistreatment or neglect. THIS WARRANTY IS IN LIEU OF ALL OTHER WARRANTIES AND NO OTHER REPRESENTATIONS OR CLAIMS OF ANY NATURE SHALL BE BINDING ON OR OBLIGATE ACCLAIM. ANY IMPLIED WARRANTIES APPLICABLE TO THIS SOFTWARE PRODUCT, INCLUDING WARRANTIES OF MERCHANTABILITY AND FITNESS FOR A PARTICULAR PURPOSE, ARE LIMITED TO THE NINETY (90) DAY PERIOD DESCRIBED ABOVE. IN NO EVENT WILL ACCLAIM BE LIABLE FOR ANY SPECIAL, INCIDENTAL, OR CONSEQUENTIAL DAMAGES RESULTING FROM POSSESSION, USE OR MALFUNCTION OF THIS ACCLAIM SOFTWARE PRODUCT.

Some states do not allow limitations as to how long an implied warranty lasts and/or exclusions or limitations of incidental or consequential damages so the above limitations and/or exclusions of liability may not apply to you. This warranty gives you specific rights, and you may also have other rights which vary from state to state.

This warranty shall not be applicable to the extent that any provision of this warranty is prohibited by any federal, state or municipal law which cannot be pre-empted.

**Repairs/Service after Expiration of Warranty**—If your software product requires repair after expiration of the 90-day Limited Warranty Period, you may contact the Consumer Service Department at the number listed below. You will be advised of the estimated cost of repair and the shipping instructions.

### **Acclaim Hotline/Consumer Service Department (516) 759-7800**

ECW is a trademark of HHG, Corp. ECW Anarchy Rulz™ and Acclaim® & © 2000 Acclaim Entertainment, Inc. All Rights Reserved. Developed by Acclaim Studios Salt Lake City. All Rights Reserved. Marketed by Acclaim. Distributed by Acclaim Distribution, Inc., One Acclaim Plaza Glen Cove, NY 11542-2777. "Debonaire" performed by Dope. Written by: Edsel Dope(ASCAP), Simon Dope(ASCAP). Courtesy of Epic Records by arrangement with: Sony Music New Media Licensing. Published by: Sony/ATV Tunes LLC/Sonic Kronic Sounds/Amputee Porno Publishing(ASCAP). "Holy Man" performed by One Minute Silence. Written by: B.Barry/One Minute Silence. Courtesy of V2 Records, Inc. Published by: Music of V2 America, Inc. Administered by: BMG Songs, Inc. "This is Extreme" performed by Harry Slash and The Slashtones. Written by Harry Slash and Roderick O. Kohn. Dave Mirra Freestyle BMX™ and Acclaim® & © 2000 Acclaim Entertainment, Inc. All Rights Reserved. Developed by Z-Axis. All Rights Reserved. Marketed by Acclaim. Distributed by Acclaim Distribution, Inc., One Acclaim Plaza, Glen Cove, NY 11542-2777.

[www.acclaim.com](http://www.acclaim.com)

[www.ecwwrestling.com](http://www.ecwwrestling.com)

[www.anarchyrulz.com](http://www.anarchyrulz.com)

### ESRB RATING

This product has been rated by the Entertainment Software Rating Board. For information about the ESRB rating, or to comment about the appropriateness of the rating, please contact the ESRB at 1-800-771-3772.

Sega is registered in the US Patent and Trademark Office. Sega, Dreamcast and the Dreamcast logo are either registered trademarks or trademarks of Sega Enterprises, LTD. All Rights Reserved. Made and printed in the USA. WARNING: Operates only with NTSC televisions and Sega Dreamcast systems purchased in North and South America (except Argentina, Paraguay and Uruguay). Will not operate with any other televisions or Sega Dreamcast systems. Product covered under one or more of the following U.S. Patents: 5,460,374; 5,525,770; 5,627,895; 5,688,173; 4,442,486; 4,454,594; 4,462,076; Re. 35,839; Japanese Patent No.2870538, (Patents pending in U.S. and other countries); Canada Patent No. 1,183,276. The ratings icon is a trademark of the Interactive Digital Software Association. Sega of America Dreamcast, Inc, P.O. Box 7639, San Francisco, CA 94120.

**SEGA®**



Look for

# Dave Mirra

freestyle  
BMX™



**CUSTOMIZE YOUR OWN TRICKS. CHOOSE YOUR OWN LINES. RIDE AS THE ABSOLUTE BEST AND GO FROM ZERO TO HERO.**

- Exclusively features 10-Time World Champion Dave Mirra
- Ride as Mirra, Ryan Nyquist or 8 other top pros
- Modify basic tricks for 1,300 different high scoring combos
- Spin, grind and stall your way through 12 huge levels of vert, dirt and street riding
- Ten different multi-player games including Longest Grind, Gnarliest Crash and more



ECW is a trademark of HHG, Corp. ECW Anarchy Rulz™ and Acclaim® & © 2000 Acclaim Entertainment, Inc. All Rights Reserved. Developed by Acclaim Studios Salt Lake City. All Rights Reserved. Marketed by Acclaim. Distributed by Acclaim Distribution, Inc., One Acclaim Plaza Glen Cove, NY 11542-2777.

Sega is registered in the US Patent and Trademark Office. Sega, Dreamcast and the Dreamcast logo are either registered trademarks or trademarks of Sega Enterprises, LTD. All Rights Reserved. Made and printed in the USA. WARNING: Operates only with NTSC televisions and Sega Dreamcast systems purchased in North and South America (except Argentina, Paraguay and Uruguay). Will not operate with any other televisions or Sega Dreamcast systems. Product covered under one or more of the following U.S. Patents: 5,460,374; 5,525,770; 5,627,895; 5,688,173; 4,442,486; 4,454,594; 4,462,076; Re. 35,839; Japanese Patent No.2870538. (Patents pending in U.S. and other countries); Canada Patent No. 1,183,276. The ratings icon is a trademark of the Interactive Digital Software Association. Sega of America Dreamcast, Inc. P.O. Box 7639, San Francisco, CA 94120.

