

SEGA
GENESIS
16-BIT CARTRIDGE



Pat Riley

BASKETBALL

INSTRUCTION MANUAL

Loading Instructions: Starting Up

1. Make sure the power switch is OFF.
2. Insert the Pat Riley Basketball cartridge in the Genesis System (shown below) by following the instructions in your Genesis System manual.
3. Turn the power switch ON. If nothing appears on the screen, recheck insertion.

IMPORTANT: Always make sure that the System is turned OFF when inserting or removing your Genesis Cartridge.

For 1 or 2 Players:

Press the Start Button on Genesis Control Pad 1.

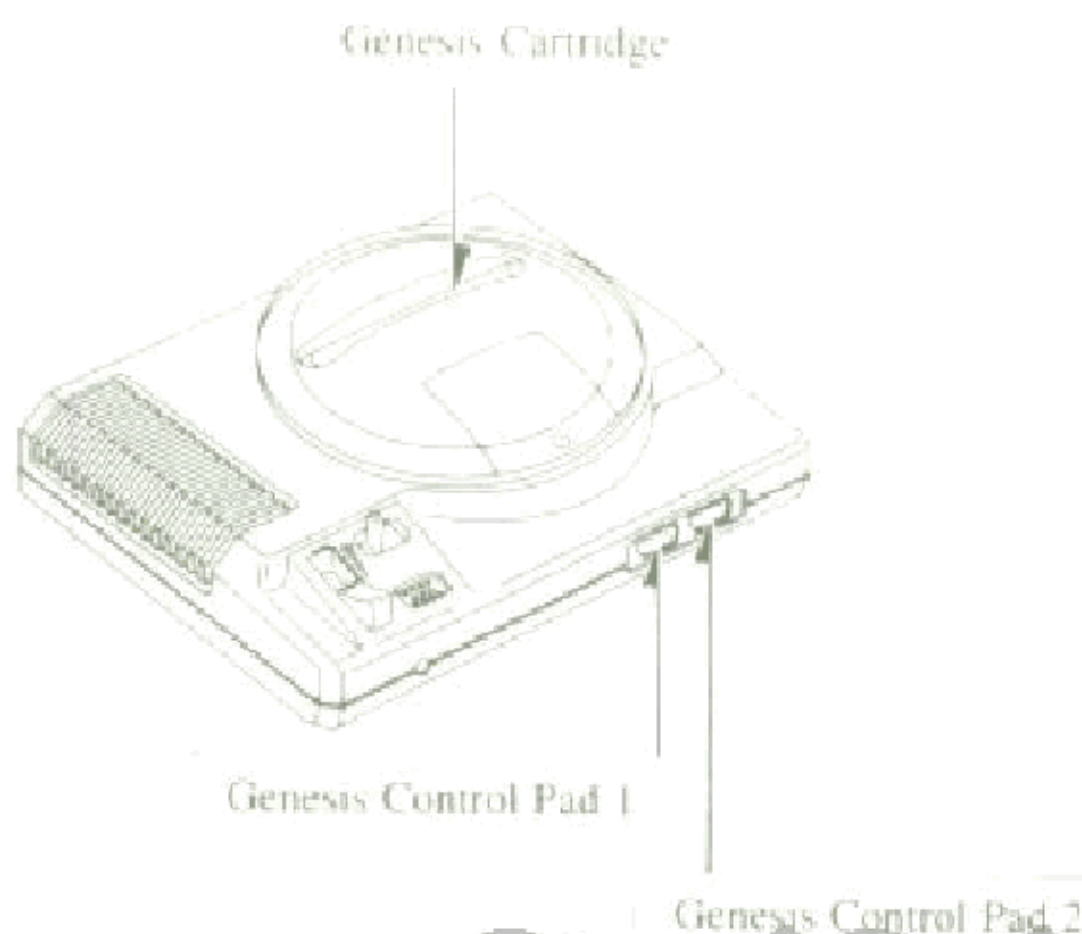

Pat Riley Basketball

Are you ready for the big time? Pat Riley Basketball from Sega brings all the fast-paced action— lightning-quick steals, thunderous slam dunks, swarming pressure defenses— right into your home! Choose any 1 of 8 teams and take on the computer, or go head-to-head with a friend (or an enemy)! Hone your skills and scout the competition in the Exhibition format, and then unleash your All-Star caliber team in the big Tournament!

You're the coach! Set the players' positions and call the defense. If the bottom starts to fall out, take a Time Out and rework your strategy before the game turns into a rout!

You're the star player! Make the great pass to your teammate in the lane! Grab that defensive rebound and start the fast break! Stuff the opponent's dunk attempts— lunchtime! If you're in range, sky high and jam one home yourself!

It's here! Pat Riley Basketball from Sega. Experience the thrill of real pro hoops! Get out there now, and give that capacity crowd what it's screaming for!



Take Control!

Learn the various functions of each button on your Control Pad before beginning play.

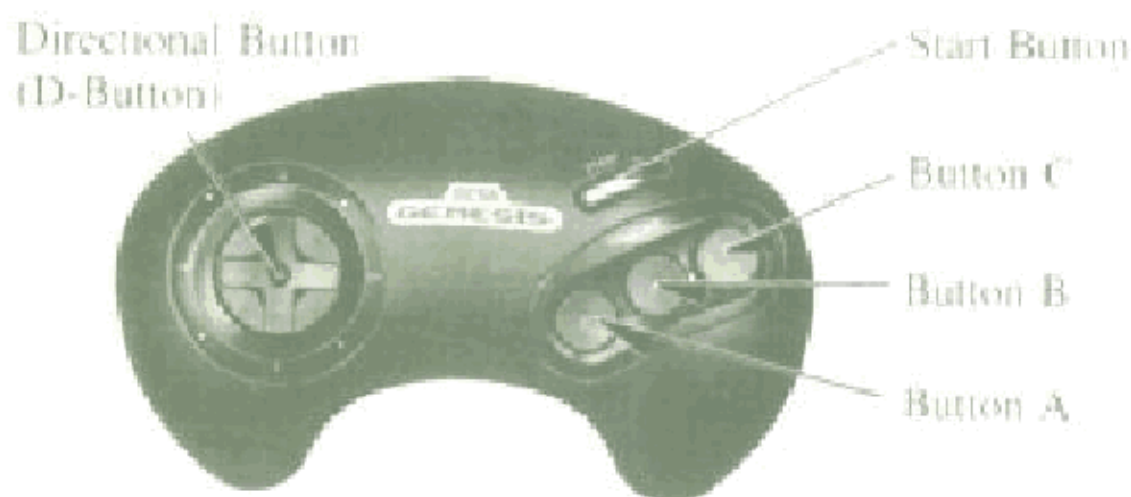

D-Button:

- Moves the selection indicator during Team and Mode selection.
- On Offense, moves the player with the ball.
- On Defense, moves the player marked with the arrow.
- On Offense, signals the direction of a pass attempt.

Start Button:

- Starts the game.
- Advances through the selection screens.
- Pauses and resumes action.

Button A:

- Calls Time Out during dead-ball situations.
- Selects players in position-change situations.

Button B:

- Shoots or dunks the ball.
- Attempts to block opponents' dunk shots.
- On Defense, moves the Control arrow to the player nearest the ball.

Button C:

- Passes the ball to a teammate.
 - Throws the ball in from out of bounds.
 - Steals the ball from an opposing player in mid-dribble.
- * To tap the ball in the center-court tip-off before each quarter, press Button A, B or C.

Getting Started

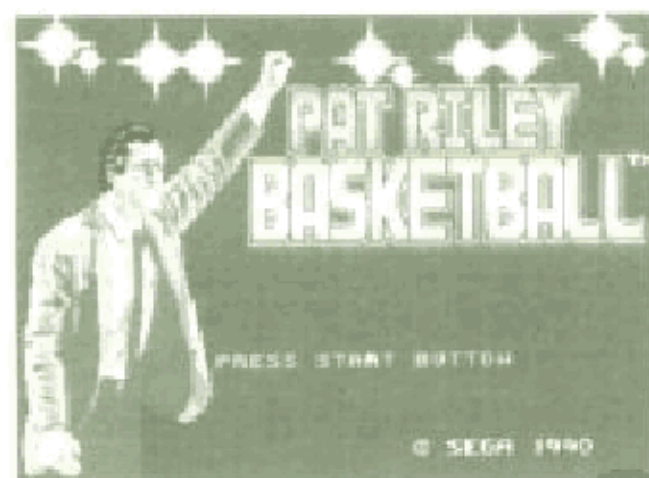

When the Title screen appears, press the Start Button to call up the first Mode Selection screen. If you want to see the Options screen first, however, press Button A, B or C instead of Start.

Options

You can perform many functions using this screen, but the two most important choices concern the length of the game and the speed of the game action.



GAME TIMES gives you the option of playing a short 20-minute game (5-minute periods), a regulation 48-minute game (12-minute periods), or an extended length 80-minute game (20-minute periods). **GAME SPEED** lets you choose the pace of the action. There are two settings— **NORMAL** and **SLOW**. To choose one or the other, press the D-Button left or right.

Other choices include **ANIMATION TEST**, which gives you a sneak peek at some of the close-up shots you'll see during the game, tests for background music and sound effects, and a **BGM SWITCH**. In the **ON** position, this function provides background music throughout your game.

To return to the Title screen, move the selection arrow down (using the D-Button) so that it points to **EXIT**, and press the Start Button.

Mode Selection

Pat Riley Basketball can be played by 1 or 2 players. If you want to see a demonstration game before you start, select **DEMO** in the Mode Selection window. To choose a mode, move the selection arrow using the D-Button, and press the Start Button.

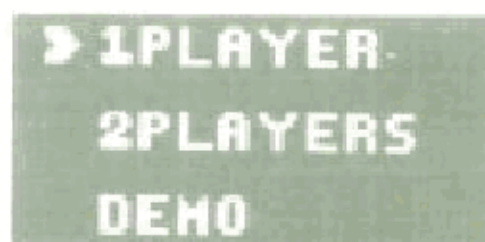

Level of Difficulty

GAME LEVEL NORMAL

You can play at 3 different levels. EASY is a good place to start.

After you've gotten used to the movements, you can graduate to NORMAL and HARD. As you move up, the opposing team does everything a bit better, and shots don't just drop for you like they did earlier.

To select a level, press the D-Button left or right until the level at which you wish to play appears. Then press the Start Button to call up the next screen.

Game Select

You can play 1 EXHIBITION game, or try to win it all in the big TOURNAMENT. To choose one or the other, move the selection arrow using the D-Button, and then press the Start Button.

► EXHIBITION
TOURNAMENT

Choose a Team

There are teams from 8 American cities here to participate in the run for the trophy. Once you've selected a game mode, you can choose the team you'll command.

A map of the United States appears. The names of the 8 cities represented are highlighted. Beneath the map, the name and photos appear for each team selected. Press the D-Button up or down to light up the indicator on the

map identifying your team, and press the Start Button. With luck, you'll choose the team that is capable of going all the way!

NOTE: Player 2 must select his team using Control Pad 2.



Player 1 and Player 2 cannot choose the same team.

Stats Screen

Before the game, you'll take a look at your team's vital information. Use the information on the players' abilities to help you set your lineup. Learn to recognize each type of information, as you'll no doubt refer back to this screen often during the game.

	SPD	STR	SHO	DEF	POINTS	SHOT	FOL
SOUVER	5	8	6	5	0	/	0
STACK	6	7	5	6	0	/	0
WARD	7	5	8	8	0	/	0
BROWN	8	9	7	4	0	/	0
CLAVERN	8	9	7	4	0	/	0

Formation: ZONE DEF

Positions:

- QB - L: CLAVERN
- QB - R: SOUVER
- WR: WARD
- WR: STACK
- TE: BROWN

Quarter: 1
Time: 12:00
Score: 0-0
SEGA

1) Player's Ability

- SPD (Speed): How fast the player is.
- SHT (Shoot): How well he shoots.
- PAS (Pass): How accurately he passes.
- DEF (Defense): How strong a defender he is.

2) Individual Statistics

- POINTS: How many points the player has scored.
- SHOT: How many shots he has taken.
- FOUL: How many fouls he's committed.

NOTE: The number of fouls each player has is noted, but he won't get kicked out of the game after 6 fouls (as in the pros). There is no foul limit. Fouls are, nevertheless, bad news to the team that commits them!

Changing Positions

You may find, as you view your team's data, that a certain player would fit better in another position. To change the positions of 2 players, follow the procedure as described below.

- 1- Select one player you want to change (using the D-Button), and press Button A. His photo begins flashing.
- 2- Choose a second player, and press Button A. His photo also starts to flash.
- 3- Press Button A one more time. The change will be official.

- FW•L.....Left Forward
- GRD•L..... Left Guard
- CEN.....Center
- GRD•R..... Right Guard
- FW•R..... Right Forward

Defensive Formations



MAN TO MAN means that each player on your team guards a specific player on the opposing team. This defense is effective when you're behind, or you want to make a quick run and score a lot of points in a hurry. Because the defensive players stay very close to their offensive counterparts, steals and interceptions become more common.



ZONE DEF means that instead of guarding one particular player, the defenders are each responsible for a specific area of the court. They defend that area against any offensive player who enters it. This is a conservative defense, and will probably be used more often than MAN TO MAN. Remember, though: a team that passes extremely well or a team that specializes in shooting from the perimeter can easily break the zone. Try to stay active on defense.

Game Screen

At any one time, you'll be able to see about 1/3 of the court. As the player with the ball moves around, the rest of the playing area gradually appears. During the game, there are several indicators that stay on screen. Become familiar with them so that a quick glance can tell you where you stand.

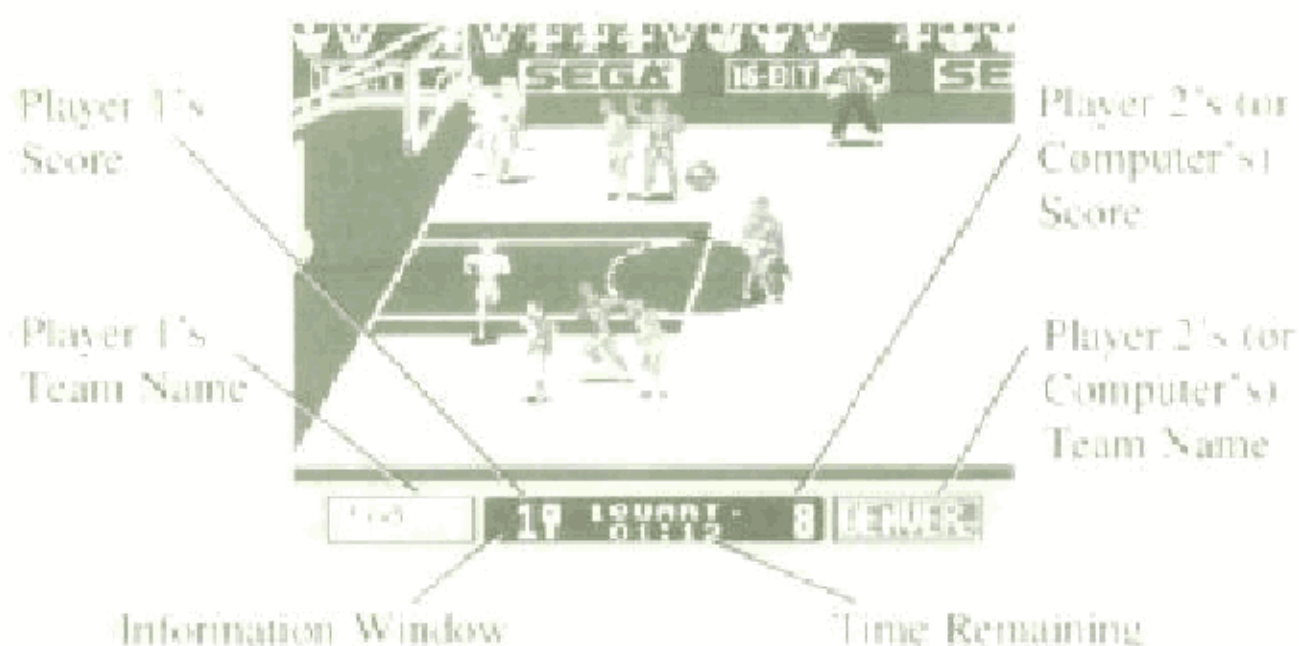

Certain lines or areas on the court are important for various reasons. The illustration below is designed to familiarize you with the playing surface.

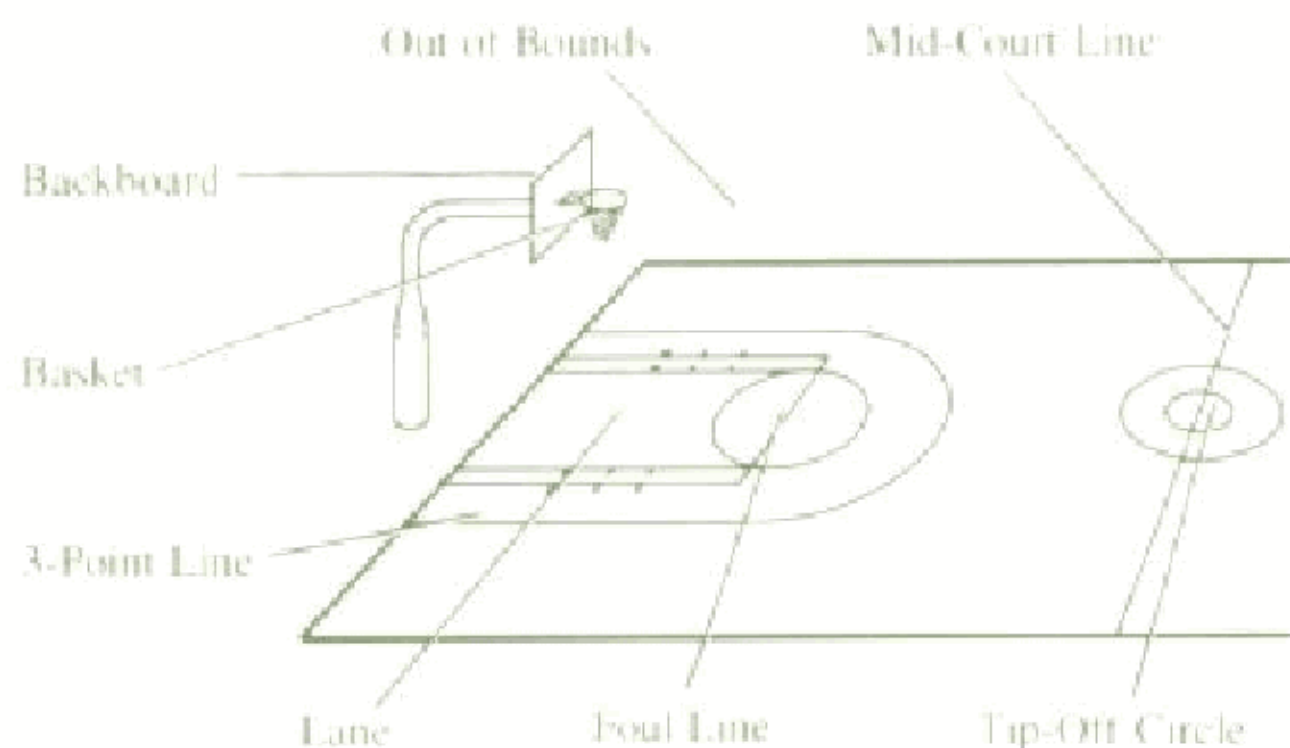

Team Introductions

Let's take a more in-depth look at each of the 8 teams that will do battle. Next to each team's nickname and photos is a brief character profile telling the kind of

game you can expect them to play. This is the most recent scouting report we've received, but things may have changed. Be on your toes!

Los Angeles Hoops

The Hoops play pretty straightforward basketball. The guards bring the ball upcourt and pass off to the forwards, who drive or shoot.

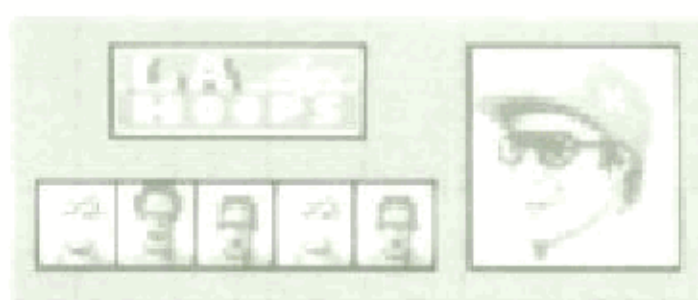

Dallas Wings

This team has a pair of guards who like to throw up 3-point bombs. Their aim is to put some points on the board quickly, to rattle the opposition.



New York Busters

The Busters' guards are great ballhandlers, and are also adept at relieving you of possession of the ball (they are a bunch of thieves!).



Seattle Bears

The guards and forwards shoot aggressively, so if they get hot, get ready for a high-scoring affair!

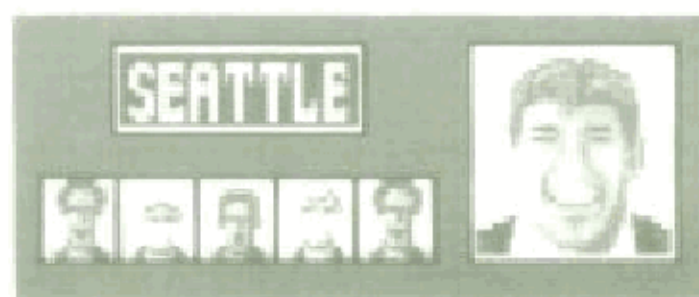

Detroit Jets

This team's strength is the ability of the guards and forwards to handle the ball in traffic and drive aggressively to the bucket.



Houston Rebels

Since there aren't any superstars on this team, they use solid, consistent play at both ends of the court to be successful.



Denver Jammers

These guys are excellent passers. They'll blow right through your zone defense, or lull you to sleep and then thread the needle.

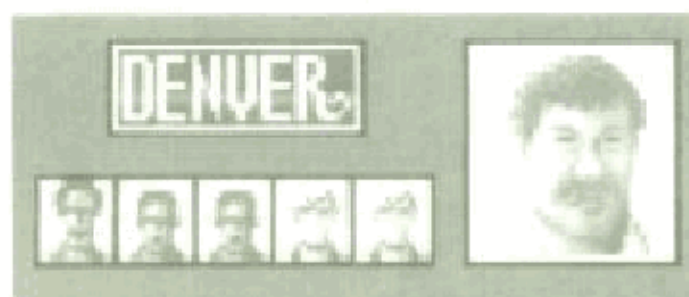

Boston Bashers

The Bashers' strength is defense. They are masters at employing and executing formations, so don't expect to run up a lot of points on them.



Tournament Play

2 players (or 1 player against the computer) can participate in an elimination tourney. In the first round, all 8 teams compete. The winners of these matches move on to the semi-finals. The 2 teams that emerge victorious from this round will square off in the final, with the victor earning the title of Pat Riley Basketball Champion!

As you play your game, the computer is busy playing the remaining teams against each other to determine the teams that will continue play. The results of the other contests appear after each game you play.

Tip-Off!



We're ready to get underway here at the packed Sega Arena! The centers from the two teams will face off in the circle at center court. On either side of the screen is a Tap gauge. To beat the other

center to the ball, press Button A, B or C as the first white ball enters the red zone of the gauge.

NOTE: All centers react to the toss-up of the ball, but some move more slowly or later than others. The best way to gain control of the tap is to use the gauge. If you tap the ball, one of your teammates will definitely get control of it.

Technique

Offense

Dribble: As the player in control of the ball is moved around with the D-Button, he automatically dribbles (bounces) the ball.

Pass: To pass the ball to one of your teammates, set the direction of the pass attempt using the D-Button, and then press Button C to make the pass. Make sure there are no defenders in your path, as they'll attempt to pick it off. If none of your teammates are in the area you are aiming at, you'll be unable to pass.

Jump: To jump, press Button B once. Make sure you're not too close to the basket, or your jump may turn into a dunk attempt, and you won't be ready! If you want to pass in mid-jump, press Button C after pressing B. If you don't let go of the ball before you touch down, though, you'll be whistled for Traveling (see page 18).

Shoot: There are 2 different types of shots you can take. A regular outside shot is taken from medium to long range. If taken outside the 3-point line, it's worth 3 points. Any shot taken from inside the line is good for 2 points if you make it. To shoot, press Button B twice.



A dunk shot is always attempted from close range, and is a very high-percentage shot. You see the attempt close up and from a variety of angles. If you press Button B

once while close to the basket, the close-up scene, complete with a Shot gauge, appears. Press Button B again when the white ball is in the red zone of the gauge, or else your slam will bounce away harmlessly!

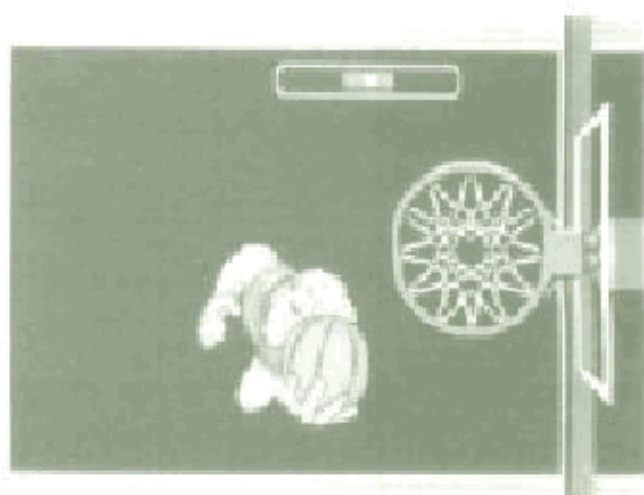

NOTE: A regular shot requires you to press Button B twice in succession. If you do the same in close range, you'll probably mess up a dunk that you weren't prepared for. It's a bit tricky at first, but you'll get used to it eventually.

Free Throws: In certain situations, you'll receive 2 free throws. This means that you'll get 2 chances to shoot from the foul line. Each shot, if made, is worth 1 point. The same Shot gauge that you see when attempting a dunk

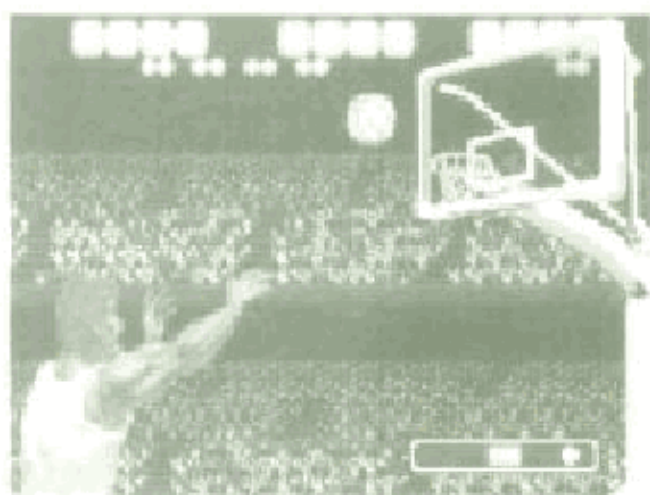

reappears. Try to press Button A, B or C and stop the white ball in the red zone of the gauge. If your timing is no good, the white ball will stop in the blue portion, and the shot will be way off the mark! Remember this, also—the white ball moves gradually faster and faster, so the longer you wait before shooting, the smaller your chances for success become!

Throw-In: After certain fouls or violations (see page 17), or after the other team scores, you'll have to throw the ball in from out of bounds. To do so, use the D-Button to direct the throw, and then press Button C. The defense

would love to pick off the inbounds pass and hit you for a quick score, so keep your eyes peeled!

Defense

Intercept a Pass: If you're on defense and you want to get the ball back in a hurry (who wouldn't?), put one of your players in the path of an anticipated pass attempt using the D-Button. If you're the slightest bit out of position, you'll miss your chance!

Steal: If you'd like to snatch the ball out of the offensive player's hands in mid-dribble, move your defender right up in his face and press Button C repeatedly. Take the ball and turn the game around!

Movement: The player that you control has an arrow over his head. If you want to switch control to another player, press Button B and the arrow automatically transfers to the player closest to the ball. If you want a player farther away to have control, specify the direction using the D-Button and press Button B.



Blocking a Dunk: You won't have the opportunity to stuff every slam, but if you have a man under the basket, he'll appear in the close-up shot with his own Block gauge. Press Button B before the white ball



moves from the red zone into the blue. If you do that successfully, even if the dunker also stopped his white ball in the red zone, you'll send him away a loser!

Fouls and Violations

Personal Foul

You're guilty of a personal foul if you touch the body of an opposing player. In Pat Riley Basketball, the two personal fouls you can be whistled for are Pushing and Charging.

Pushing occurs when a defensive player pushes or makes contact with the offensive player in possession of the ball. If the foul was committed in the offensive team's backcourt, the offensive team restarts play by throwing the ball in from out of bounds. If it happened in their frontcourt (the side of the court near the guilty team's basket), they receive 2 free throws.



Charging is committed by the offensive player with the ball, as he crashes into a defensive player who's in a set position. The result is a throw-in for the victimized team (ball possession changes). This is more common in the 2 PLAYERS mode.

Violation

This category includes any infraction that doesn't involve body contact. After the violation is indicated,

play resumes with a throw-in by the other team. (The team that commits a violation always loses possession.)

Out of Bounds

This occurs when the ball crosses one of the 4 boundary lines, either by means of an errant pass or in the hands of a player.

Traveling

In this game, Traveling occurs when a player in possession of the ball jumps and touches down without letting go of the ball. This is, by far, the most commonly whistled violation.

Over and Back

This violation happens when the ball crosses back over the mid-court line into the offensive team's backcourt. It may happen on a pass attempt, or if the player who has the ball accidentally steps back over the line while avoiding a defender.

5-Second Violation

On a throw-in, you have 5 seconds to get the ball in bounds. If you can't, a message appears in the Information Window and you lose possession.

10-Second Violation

After the other team scores, you have 10 seconds to move the ball over the mid-court line. If you can't, you'll be called for this infraction and lose possession.

24-Second Violation

Once you bring the ball across the mid-court line, you have 24 seconds to get off a shot attempt. If you can't or don't shoot within that time, you give up the ball. This is not a common occurrence.

Strategy

You are the coach— the person your players depend on for guidance and courage when the going gets tough. You have the power and the responsibility to change player positions or defensive formations during the game. At the beginning of each quarter, the Stats screen appears, and you can make your changes (if any are necessary).

Time Out

Is the other team gaining its second wind? Have they just run off 10 or 12 unanswered points? If so, you might consider taking a breather and changing strategies. To call Time Out, press Button A when the ball is not in play (for example, before a throw-in). This is called a dead-ball situation. You only have 1 time out per quarter, so don't squander them! If you want to dry the sweat off your hands, press the Start Button and pause the action!

Final Tournament Notes

You'll see all the team names in the Tournament Bracket before each round. Player 1's team appears in the top left corner of the format, and Player 2's team (if there are two of you) shows up in the top right corner. You

probably won't face each other in the first round. Player 1's game will come first, followed by Player 2's game. If both teams keep winning, they just might end up knocking heads in the Championship game! Good luck!

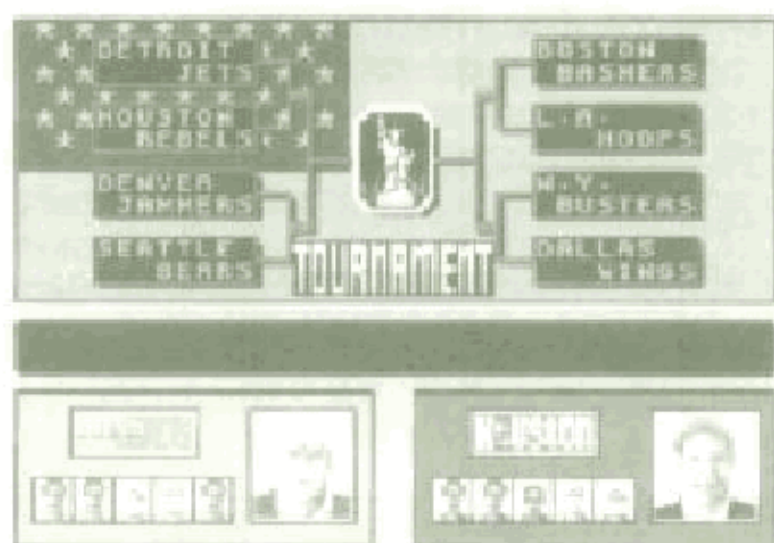

Helpful Hints

- Never underestimate the importance of the Stats screen. All the information that you need to be successful is right there!
- Practice at all 3 levels of difficulty, and notice the differences. Then, the next time a friend wants to take you on at the Hard level, you'll have a headstart!
- Stealing the ball from the offense is the best way to increase your scoring. You'll have the ball more often, with more chances to shoot!
- Fouls won't get anyone thrown out of the game, but if you commit a Pushing foul late in a tie game and the other team sinks both free throws, you'll certainly regret having been so aggressive! Keep this in mind as the game winds down, especially if it's close.

Scorebook

Date
Name
Score

Date
Name
Score

Date
Name
Score

Date
Name
Score

Date
Name
Score

Scorebook

Date
Name
Score

Date
Name
Score

Date
Name
Score

Date
Name
Score

Date
Name
Score

Handling The Sega Genesis Cartridge

- The Sega Genesis Cartridge is intended exclusively for the Sega Genesis System™.
- Do not bend, crush or submerge in liquids.
- Do not leave in direct sunlight or near a radiator or other source of heat.
- Be sure to take an occasional recess during extended play.

Warranty

Sega of America, Inc., warrants to the original consumer purchaser that the Sega Genesis Cartridge shall be free from defects in material and workmanship for a period of 90 days from the date of purchase. If a defect covered by this warranty occurs during this 90-day warranty period, Sega will repair or replace the defective cartridge or component part, at its option, free of charge.

This warranty does not apply if the defects have been caused by negligence, accident, unreasonable use, modification, tampering, or any other causes not related to defective materials or workmanship.

To receive fast, reliable warranty service, call the Sega Consumer Service Department at the following number:

1-800-USA-SEGA

Our Consumer Service Department is in operation from 6:00 a.m. to 9:00 p.m. (Pacific Time), Monday through Friday and from 8:00 a.m. to 6:00 p.m. (Pacific Time), Saturday and Sunday. **DO NOT RETURN YOUR SEGA GENESIS CARTRIDGE TO YOUR RETAIL SELLER.** Return cartridge to Sega Consumer Service. Please call first for further information.

If the Sega technician is unable to solve the problem by phone, we will provide you with instructions on returning your defective cartridge to us. The cost of returning the cartridge to Sega's Service Center shall be paid by the purchaser.

Repairs After Expiration of Warranty

If your Sega Genesis Cartridge requires repairs after termination of the 90-day warranty period, you may contact the Sega Consumer Service Department at the number listed above. If the technician is unable to solve the problem by phone, he will advise you of the estimated cost of repair. If you elect to have the repair done, you will need to return the defective merchandise, freight prepaid and insured against loss or damage, to Sega's Service Center with an enclosed check or money order payable to Sega of America, Inc. for the amount of the cost estimate provided to you by the technician. If, after inspection, it is determined that your cartridge cannot be repaired, it will be returned to you and your payment will be refunded.

Limitations on Warranty

Any applicable implied warranties, including warranties of merchantability and fitness for a particular purpose, are hereby limited to ninety days from the date of purchase and are subject to the conditions set forth herein. In no event shall Sega of America, Inc., be liable for consequential or incidental damages resulting from the breach of any express or implied warranties.

The provisions of this warranty are valid in the United States only. Some states do not allow limitations on how long an implied warranty lasts, or exclusion of consequential or incidental damages, so the above limitation or exclusion may not apply to you. This warranty provides you with specific legal rights. You may have other rights which vary from state to state.

©1990 Sega of America, Inc.

Sega of America, Inc. P.O. Box 2167, South San Francisco, CA 94080

Printed in Japan