

P.O.W.

PRISONERS OF WAR



GAME MANUAL



INTRODUCTION

Congratulations on selecting this fine SNK game. This product has been constructed of the finest materials available to ensure many years of reliable service. The cabinet has been fabricated by Dynamo Corporation, the monitor is manufactured by Wells-Gardner Corporation, the coin door is from Coin Controls, Incorporated, and the game PCB was developed and manufactured by SNK Corporation in Japan.

The Dynamo production staff was responsible for assembling and packaging the final product that you have here. These folks manufacture games for many of the major game suppliers and are highly respected for their fine workmanship. As is true with any product regardless of how carefully it is constructed, imperfections can occasionally slip through the inspection. Therefore, before applying power to your new game, please take a few moments to examine the game to ensure all assemblies are secured, connected, and no signs of physical damage are evident.

The game pcb is a sophisticated hi-speed computer system. It has been developed by SNK Corporation to provide the fine graphics, sound, and control response essential for success of this game. Due to the complex nature of it's design, we strongly recommend that in the event a failure of this system occurs, do not attempt to make repairs in the field. Please note that repairs made or attempted in the field will void the 90 day warranty provided with each game. During the warranty period, replacement pcs are available simply by contacting your local SNK Authorized Distributor. You must supply the Cabinet Serial Number when requesting a replacement pcb from your distributor.

The staff of SNK Corporation is pleased that you have chosen our product for your business. Feel free to call upon us for any assistance that we may provide you. We have included a Customer Response Form in the back of this manual. Please take a few moments to write down your thoughts and comments in the space provided. Your firm will be placed on a mailing list for Technical and Field updates.

P.O.W.
(PRISONERS OF WAR)

UPRIGHT GAME MANUAL

TABLE OF CONTENTS

I. GENERAL INFORMATION

A. SNK WARRANTY POLICY.....	1
B. SET-UP INSTRUCTIONS.....	2

II. OPERATION INFORMATION

A. GAME PLAY.....	3
B. DIP-SWITCH SELECTABLE OPTIONS.....	4
C. SELF-TEST DESCRIPTION.....	5

III. TECHNICAL INFORMATION

A. WIRING DIAGRAM.....	7
B. REPLACEMENT PARTS LIST.....	8

© 1988 SNK CORPORATION OF AMERICA
246 SOBRANTE WAY
SUNNYVALE, CA. 94086

FIRST PRINTING
8/15/88

I. GENERAL INFORMATION

A. SNK Warranty Policy.

SNK Corporation of America (Seller) warrants to the original purchaser (Buyer) that the products listed below are free from defects in manufacturing and materials.

The warranty period is 90 days, and is effective from the date of original shipment from Seller's factory. The items covered by this warranty are specified as follows:

GAME CPU PRINTED CIRCUIT BOARD(S)
POWER SUPPLY SWITCHING REGULATOR
MONITOR ASSEMBLY

No other parts of Seller's product are covered by this policy.

The Seller's sole responsibility shall be, at its discretion, to repair or replace any warranted items found to be defective during the warranty period. The Buyer's responsibility shall be to notify Seller that defective material has been received, and return it, freight pre-paid, as per Seller's instructions.

Seller is not responsible for any costs of unauthorized repairs, loss of income, or any other charges or losses incurred as a result of the use of this product. Seller does not warrant the suitability of its product for a particular application.

This warranty will be void if inspection of the product shows damage was the result of misuse, or if unauthorized repairs were attempted, or if the item was damaged due to handling, shipping, customer negligence, or abuse.

B. Set-up Instructions

The P.O.W. (Prisoners of War) game is shipped adjusted, tested, and ready for operation. The only assembly required is the installation of the four (4) Leg Levelers to the floor of the cabinet. These can be found packed in the Cash Box. To install the Leg Levelers, lay the game down onto it's back and screw the levelers into the threaded holes in the floor of the cabinet. Restore the cabinet to the upright position and adjust the leveler's until the cabinet sits flat and does not rock. Tighten the retaining hex nuts to secure.

At this point, the game is ready to operate, however you may need to alter the Dip-Switch Options and set the proper Sound Volume level. Refer to the Dip-Switch table in Chapter II, section B for specific information. The Sound Volume is adjustable via a trimpot found on the Main CPU pcb. See figure 1 for the locations of the Dip-Switches and Volume Control.

The Power Supply voltage (+5vdc) has been pre-set at the factory to between +4.90vdc to +5.15vdc at the CPU PCB edge connector. The two power supply check LEDs on the CPU PCB are for for indicating that the voltage is present only, they do not indicate proper voltage level is set.

FIGURE 1

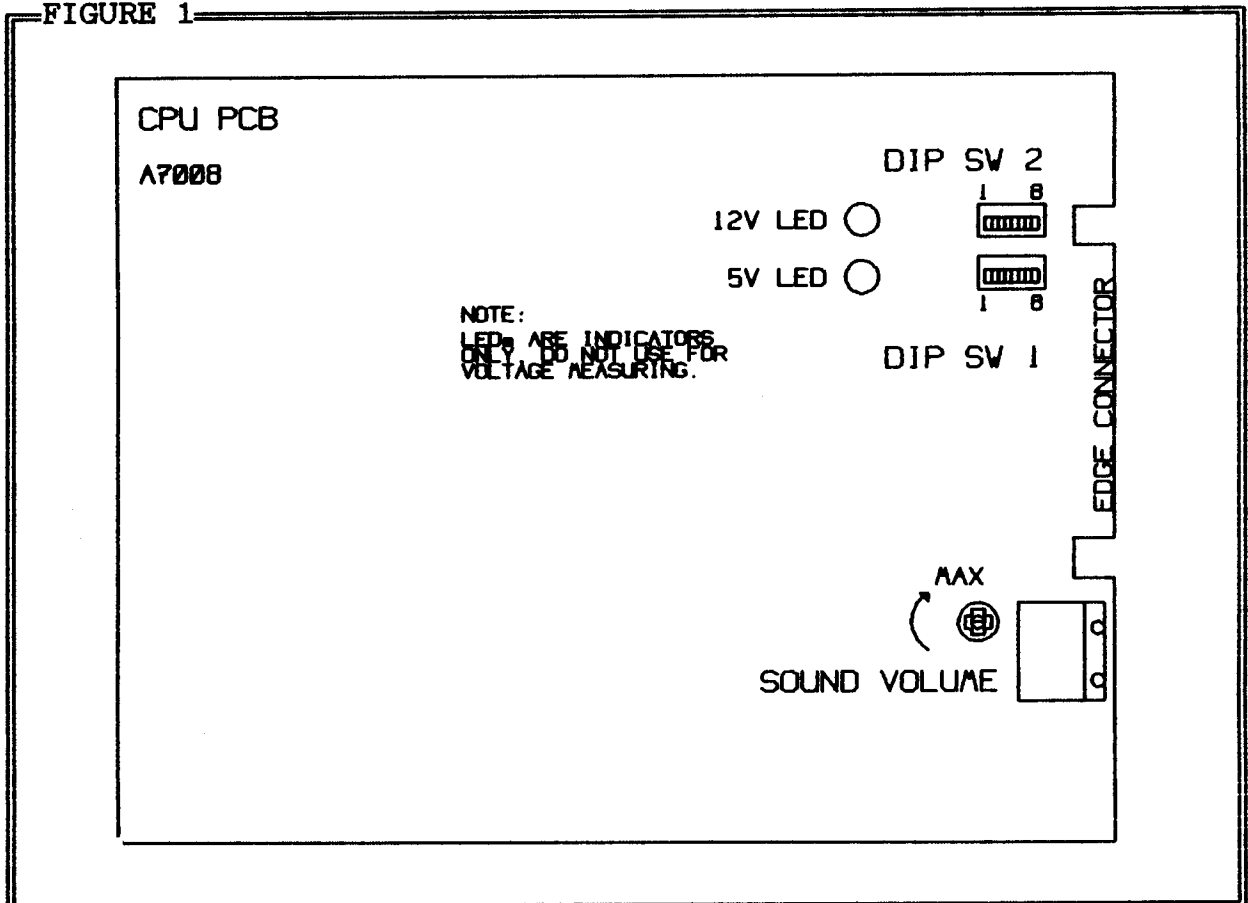

II. OPERATION INFORMATION

A. Game Play.

P.O.W. (Prisoners of War) is a one or two player interactive coin operated video game. The player controls his "Prisoner" via one 8-way joystick and three push-buttons (see figure 2). The function of the joystick is to maneuver the player image up, down, left, and right on the screen. The three push-buttons control the attack and jump functions of the player image.

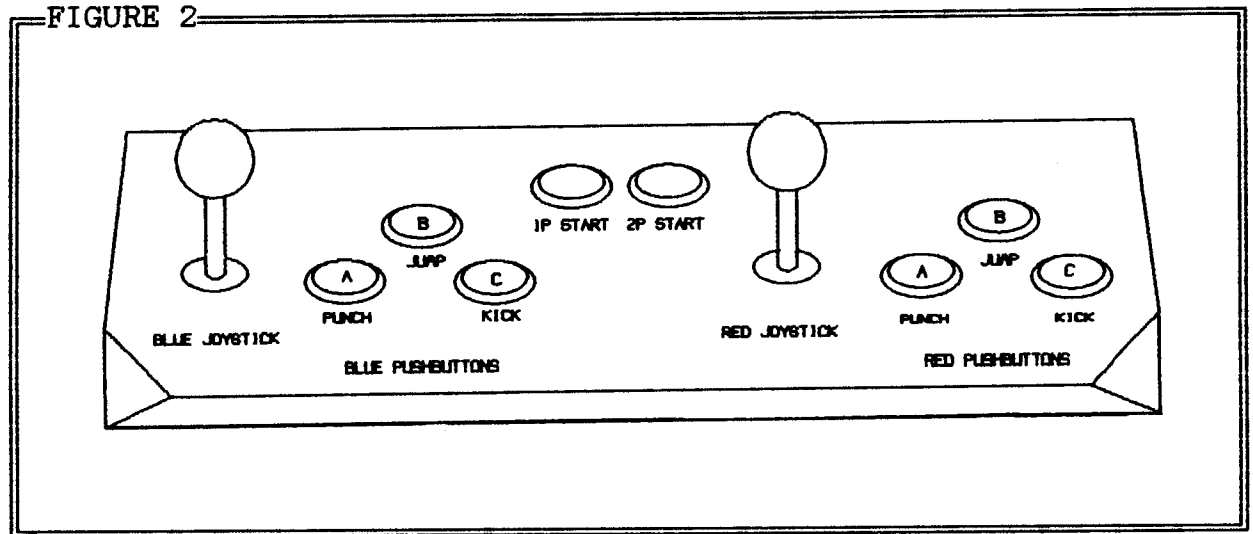

The player is attempting a daring escape from a enemy prison camp. At the start of a game, the game displays an animated scene of the prisoner(s) blowing open the door of their cell. They then try to move thru the prison camp to freedom. Along the way, the enemy is attacking them to prevent their escape. Many of the enemy soldiers are armed with knives and sub-machine guns, which the player can knock out of the enemy's hands and use to his advantage.

The possible moves and combination moves are shown below:

BUTTON	WITH NO WEAPON	WITH KNIFE	WITH GUN
A	PUNCH	THROW KNIFE	HIT WITH GUN
B	JUMP	JUMP	JUMP
C	KICK	KICK	SHOOT GUN
A + B	BACK PUNCH	N/A	N/A
A + C	HEAD BUTT	N/A	N/A
B + C	JUMP KICK	JUMP KICK	JUMP KICK

B. Dip-Switch Options.

The P.O.W. game can be adjusted for optimum suitability for the location in which it is to be operated. To alter the current settings, remove power to the game, locate the two banks of 8 position Dip-Switches (see figure 1), and change the position of the switches to the required options. Use a small flat blade screwdriver or your fingernail to change the settings of the switches.

FIGURE 3

SWITCH 1	CONTENTS	1	2	3	4	5	6	7	8	
SCREEN ROTATION	NORMAL	OFF								
	REVERSE	ON								
BONUS OCCURENCE	SECOND BONUS			OFF						
	EVERY BONUS			ON						
NO OF METERS	TWO (2)		ALWAYS OFF		OFF					
	THREE (3)				ON					
GAME PRICING COIN1	1COIN/1PLAY						OFF	OFF		
	2COIN/1PLAY						ON	OFF		
	3COIN/1PLAY					OFF	ON			
	4COIN/1PLAY					ON	ON			
GAME PRICING COIN2	1COIN/1PLAY							OFF	OFF	
	1COIN/2PLAY							ON	OFF	
	1COIN/3PLAY							OFF	ON	
	1COIN/4PLAY							ON	ON	

SWITCH 2	CONTENTS	1	2	3	4	5	6	7	8
GAME DIF-FICULTY LEVELS	(2) STANDARD	OFF	OFF						
	(1) EASY	ON	OFF						
	(3) HARD	OFF	ON						
	(4) VERY HARD	ON	ON						
DEMO MODE SOUND	YES			OFF	OFF				
	NO			ON	OFF				
GAME MODE	NEVER FINISH			OFF	ON				
	STOP DISPLAY			ON	ON				
BONUS 1ST/2ND	20000/50000					OFF	OFF		
	40000/100000					ON	OFF		
	60000/150000					OFF	ON		
	NO BONUS					ON	ON		
CONTINUE GAME MODE	YES							OFF	
	NO							ON	
MODE	GAME MODE								OFF
	TEST MODE								ON

C. Self Test Description.

The Memory IC's (Integrated Circuits) and Sound Circuit is automatically checked each time power is applied. In the event a problem is detected, the test will stop and an Error Code will be displayed on the screen. This is an indication only, and should be utilized only as a starting point for trouble-shooting.

To place the game in Manual Self Test mode, set switch 2 of Dip-Switch 2 to the 'ON' position and apply power to the game. The screen will display a the first test. Press the 1 Player Start button to advance to the next test.

The sequence of tests are as follows:

1. DIP MODE CHECK

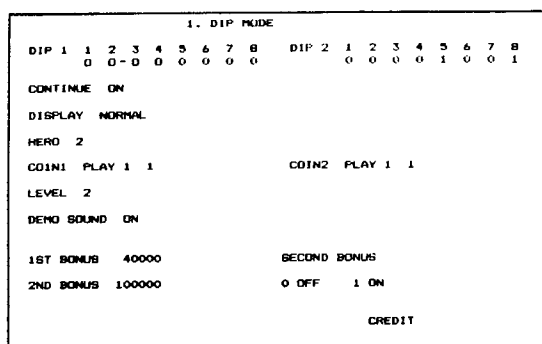

Set up the Dip-Switch settings as per the Table in Figure 3. The screen displays each bit as a '1' or '0' (on or off).

2. CROSS-HATCH

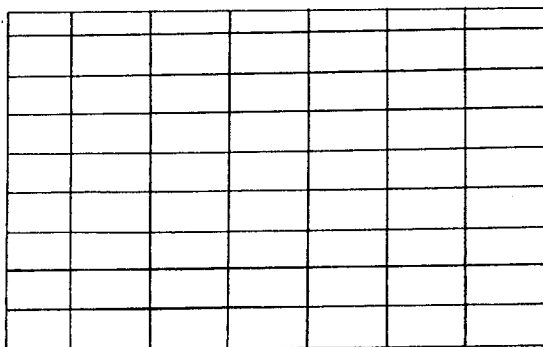

Adjust monitor for a square pattern throughout the display and on the edge of the monitor.

3. COLOR TEST

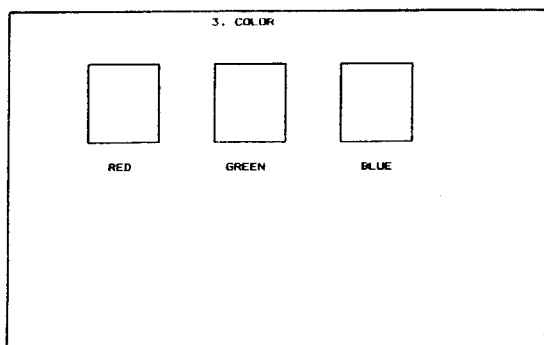

Assure that the colors are properly wired to the monitor, and adjusted for proper intensity.

4. LEVER & BUTTON TEST

		4. LEVER								
		0 OFF				1 ON				
		START1				NEXT				
	P1	P2	1	2	3	4	5	6	7	8
UP	0	0	DIP1	0	0	0	0	0	0	0
DOWN	0	0	DIP2	0	0	0	1	0	0	1
LEFT	0	0								
RIGHT	0	0								
PUSH1	0	0								
PUSH2	0	0	SERVICE							0
PUSH3	0	0	COIN1							0
START2	0	0	COIN2							0

When a joystick or button is activated, the '0' on the display will turn to a '1'.

5. BACK CHARACTER TEST

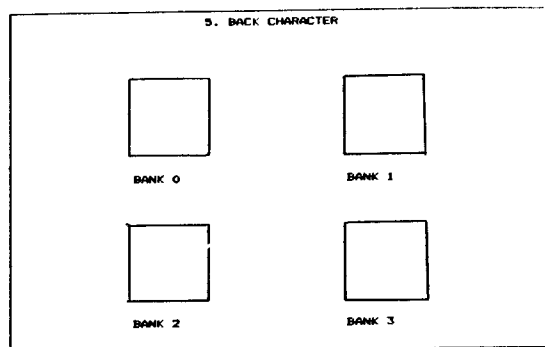

Confirm that the characters are displayed on the monitor. Move Blue joystick to change image.

6. SPRITE TEST

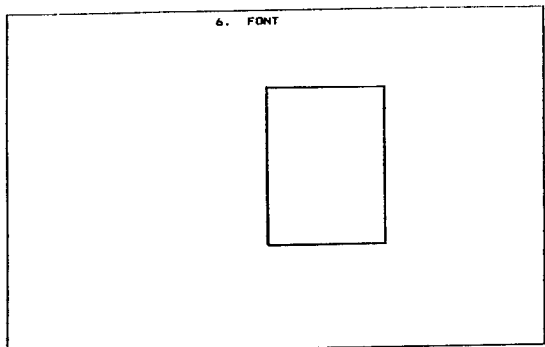

Confirm that the Blue Hero Character is displayed on the monitor. Move Blue joystick to change image and position.

7. SOUND TEST

7. SOUND	
SOUND CODE	= 40
MUSIC	40 7B
EFFECT	B1 BF
VOICE	C0 FF
STOP	DE

Set up the Sound Code (?) to 41-7B or 81-BB by moving the joystick, or by pressing the Kick Button at CO-FF.

Set the Sound Code to OE and press the Kick Button to stop the sound.

III. TECHNICAL INFORMATION

A. Wiring Diagram.

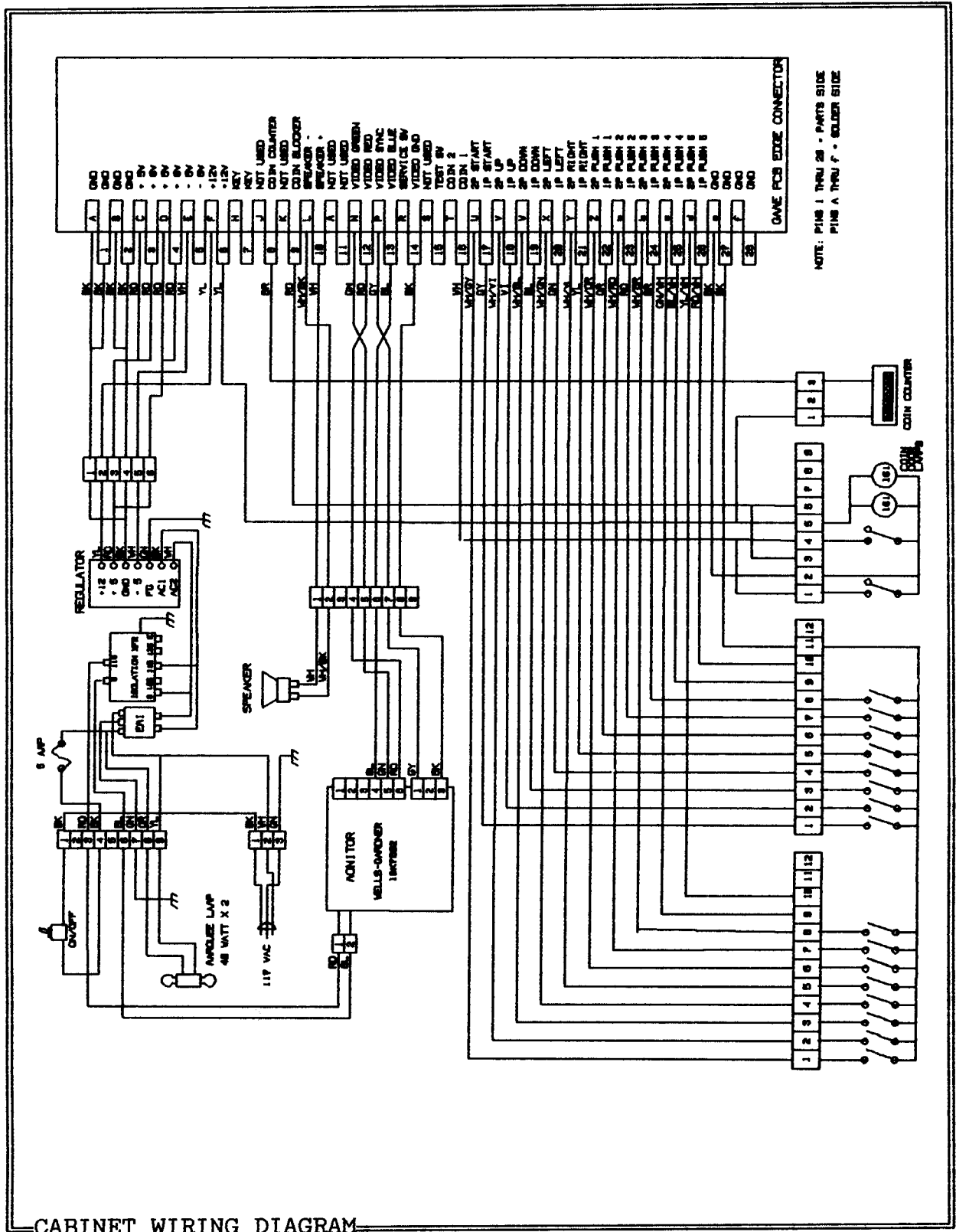

C. Replacement Parts List.

The following list contains the replacement parts available for your P.O.W. (Prisoners of War) game. These parts are available from any authorized SNK distributor. When ordering replacement parts, please specify the name of the game, item number, and description. This will aid in expediting your order.

FINAL ASSEMBLY, P.O.W. UPRIGHT GAME

- 1 CABINET ASSEMBLY (DYNAMO HS-1)
- 2 MONITOR ASSEMBLY, 19" DIA. (WELLS-GARDNER 19K7602)
- 3 POWER SUPPLY ASSEMBLY, 11AMP (DYNAMO)
- 4 COIN DOOR ASSEMBLY (COIN CONTROL #10-1110-09)
- 5 CONTROL PANEL ASSEMBLY, P.O.W.
- 6 PCB ASSEMBLY, P.O.W.
- 7 LOGO PLEX, P.O.W.
- 8 TUBE CARD, P.O.W.
- 9 SIDE DECAL, LEFT, P.O.W.
- 10 SIDE DECAL, RIGHT, P.O.W.
- 11 MANUAL, P.O.W. OPERATION & SERVICE

POWER SUPPLY ASSEMBLY, 11 AMP

- 12 SWITCHING REGULATOR (IMPERIAL 11 AMP)
- 13 ISOLATION TRANSFORMER, 115VAC, 1 AMP (RAVENSWOOD)
- 14 EMI FILTER, 5 AMP (CORCOM)

CONTROL PANEL ASSEMBLY, P.O.W.

- 15 CONTROL PANEL, BARE, P.O.W.
- 16 CONTROL PANEL OVERLAY, P.O.W.
- 17 JOYSTICK, 8-WAY MICROSWITCH, RED (HAPP)
- 18 JOYSTICK, 8-WAY MICROSWITCH, BLUE (HAPP)
- 19 PUSHBUTTON, MICROSWITCH, RED (HAPP)
- 20 PUSHBUTTON, MICROSWITCH, BLUE (HAPP)
- 21 PUSHBUTTON, 1 PLAYER START (HAPP)
- 22 PUSHBUTTON, 2 PLAYER START (HAPP)
- 23 REPLACEMENT MICROSWITCH, (CHERRY D44 OR EQUIVALENT)