



**Do! Do! Do! Ruin Ruin**

**SERVICE MANUAL**

**UNIVERSAL<sup>®</sup>**

# WARNING:

THIS EQUIPMENT GENERATES AND USES RADIO FREQUENCY ENERGY AND IF NOT INSTALLED AND USED PROPERLY, I.E., IN STRICT ACCORDANCE WITH THE INSTRUCTIONS MANUAL, MAY CAUSE HARMFUL INTERFERENCE TO RADIO COMMUNICATIONS. IT HAS BEEN TESTED AND FOUND TO COMPLY WITH THE LIMITS FOR A CLASS A COMPUTING DEVICE PURSUANT TO SUBPART J OF PART 15 OF FCC RULES, WHICH ARE DESIGNED TO PROVIDE REASONABLE PROTECTION AGAINST SUCH INTERFERENCE WHEN OPERATED IN A COMMERCIAL ENVIRONMENT.

OPERATION OF THIS EQUIPMENT IN A RESIDENTIAL AREA IS LIKELY TO CAUSE INTERFERENCE IN WHICH CASE THE USER AT HIS OWN EXPENSE WILL BE REQUIRED TO TAKE WHATEVER MEASURES MAY BE REQUIRED TO CORRECT THE INTERFERENCE.

## UNIVERSAL

This documentation provides standard information.  
Universal reserves the right to change without notice.

## CONTENTS

<b>Introduction</b> .....	<b>i</b>
<b>Parts List</b> .....	<b>ii</b>
<b>Cabinet Requirements</b> .....	<b>iii</b>
<b>Control Panel Installation</b> .....	<b>iv</b>
<b>Wiring Installation</b> .....	<b>v</b>
<b>F.C.C. Requirements</b> .....	<b>vi</b>
<b>I. How to Play</b> .....	<b>1</b>
<b>II. Various Option Settings</b> .....	<b>2</b>
<b>III. How to conduct self-testing</b> .....	<b>3-5</b>
<b>IV. Main circuit board IC location and parts list</b> .....	<b>6-7</b>

## REFERENCE DRAWINGS

<b>Fig. 1 Wiring Harness Pin Assignment</b> .....	<b>8</b>
<b>Fig. 2 Modification For Separate Sync Outputs</b> .....	<b>9</b>
<b>Fig. 3 Control Panel Accessories and Layout</b> .....	<b>10</b>
<b>Fig. 4 Sound Amplifier Diagram</b> .....	<b>11</b>



UNIVERSAL U.S.A., INC. INTRODUCES

**DO! RUN RUN**

**Do! Run Run** is manufactured and marketed as a conversion for coin-operated video games. This manual is designed for the use, maintenance and installation of this product.

Installation, maintenance or repair should only be attempted by qualified service personnel.

Technical assistance is available by calling:

1-800-538-7548 Outside California.

1-408-727-4591 Inside California.

172247 Telex

Upon receipt of your Universal U.S.A. conversion kit be sure to verify that all contents are complete and free from defects or damage. Notify your distributor of any discrepancies in the kit as soon as possible.

Your Do! Run Run Conversion Kit includes:

- A) 1 - Do! Run Run P.C.B. (Contained in R.F. shield). UNIVERSAL PART #02-10023-00  
(06-10100-00)
- B) 1 - Audio-amplifier P.C.B. UNIVERSAL PART #02-10100-00
- C) 1 - Main wiring harness assembly. UNIVERSAL PART #03-10100-00
- D) 1 - 4/8 way joystick assembly. UNIVERSAL PART #04-05000-00
- E) 2 - Push buttons (Complete with housing). UNIVERSAL PART #04-05111-00/04-05202-00
- F) 1 - 24" x 9" clear control panel plexi glass. UNIVERSAL PART #05-00005-00
- G) 1 - Set of control panel decals. UNIVERSAL PART #05-23107-00
- H) 1 - Polycarbonate control panel overlay. UNIVERSAL PART #05-23105-00
- I) 1 - Do! Run Run Marquis (Title) decal. UNIVERSAL PART #05-23000-00
- J) 2 - Do! Run Run side decals. UNIVERSAL PART #05-23120-00
- K) 1 - Do! Run Run instruction decal. UNIVERSAL PART #05-23110-00
- L) 1 - Do! Run Run license sticker.

## Cabinet Requirements

The **Do! Run Run** Conversion Kit can be installed into any standard cabinet (Upright or cocktail). The game is designed to display on any standard horizontally mounted, color (R.G.B.), rastorscan monitor.

Many cabinets allow for the repositioning of monitors from verticle to horizontal mountings. Repositioning of a verticle mounted monitor is a delicate, if not cumbersome operation and extreme care should be exercised in handling any monitor. It is recommended that the installation of the **Do! Run Run** Conversion Kit be attempted only on those cabinets inwhich monitors are presently mounted horizontally or in such cabinets, where by design facilitates the repositioning or mounting of monitors to be easily interchangeable. It is not recommended that cabinets be physically altered or any reconstruction of cabinets be done by anyone other than those qualified and having the appropriate facilities to conduct such operations.

The **Do! Run Run** P.C.B. will require regulated voltages of +5 and +12 VDC. Most standard power supplies will provide these voltages, therefore the replacement of existing power supplies may not be necessary. Along with the monitor and power supply; the control panel, speaker and coin door need to be retained from the existing cabinet.

## Control Panel Installation

Parts furnished with the **Do! Run Run** conversion kit for the control panel modification are pictured and listed on page 10, diagram A; as well as an installation layout.

Begin removing the existing controls and graphics, then prepare the surface by cleaning and removing any foreign material and debris. Take note of the existing holes in the panel to determine placement of the new controls.

NOTE: Repositioning and drilling holes to install the new controls on the exisiting control panel may be necessary and require the use of power tools. In the event such tools are needed exercise extreme caution. If assistance is required, contact a local Universal U.S.A. Distributor.

Apply the polycarbonite overlay to the top of the control panel and trim away any excess material around the edges and holes to be used for the new controls. Attach the indication decals (I.E., joystick, "Run", 1 player and 2 player) on top of the overlay next to the corresponding holes.

If needed or desired, measure and cut the clear plexi glass furnished with the kit to fit the existing control panel. Drill holes for the controls at 1 1/8 inches in diameter to accommodate the joystick and buttons where needed. Be sure to file or sand away any rough corners around the edges of the plexi glass.

### Wiring Installation

All wiring terminations and connections for the **Do! Run Run** conversion kit are in the secondary or low voltage circuit (Less than 42 VDC).

#### Electrical Cautions:

- Never attempt installation, connection, or electrical terminations with power applied to the unit.
- Never disconnect the Printed Circuit Board(s) with power applied.
- Never replace any components with anything other than exact replacement parts.

Begin the wiring process by removing the existing P.C.B.(s) and wiring harness(s). Physically secure the **Do! Run Run** P.C.B. and audio amplifier P.C.B. to the inside of the cabinet. Pin assignment and termination points of the harness assembly are provided on page 8 of the manual.

Termination of the wiring harness can be separated into five (5) basic categories.

1. Power Inputs: +5 VDC, +12 VDC and Ground
2. Video Outputs: Red, Green, Blue, Video Ground and Sync.
3. Player Controls: Up, Down, Left, Right, Run, 1st and 2nd Player Start
4. Coin Door: Left Coin, Right Coin, Slam Switch and +5 VDC (Coin Meter)
5. Audio Output: Speaker

1. Power Inputs: Termination of the voltage leads is probably the most critical and fundamental process of the installation. Extreme caution should be taken to insure correct terminations and proper voltages. The voltage input lines are distinguishable, as 18 gauge wire is used for each. (+5 VDC-Orange at pin #3, +12 VDC-Red at pin #8 and Ground-Black at pin #1). Before proceeding, verify that each input voltage is correct and at the proper designated pin assignment of the P.C.B. connector.

2. Video Outputs: Connections can be made by terminating the Red (Pin Z), Green (Pin A), Blue (Pin B) and Video Ground (Pin E) to the corresponding inputs of the monitor. To connect the sync output(s), first determine what inputs are needed by the monitor. The composit sync, White wire at (Pin C), can be terminated to the composit sync input of the monitor, if applicable. Do! Run Run will generate a negative composit sync. In most cases where negative horizontal and vertical sync is needed, terminations can be made by connecting the White composit sync line to both negative H & V inputs of the monitor.

If a positive signal is needed, see the modification on page 9 or contact your local distributor to obtain a Universal 8300-TV-B Video P.C.B. (This assembly can be used to modify sync signals).

NOTE: The leads at pins #5 (Orange) and #6 (Brown) are designated for vertical and horizontal sync outputs and are needed only for the modification on page 9.

If the display appears on the screen "Upside-Down" the display can be turned by a dip-switch setting. (Dip-switch A-SW5 — See option settings on page 2).

3. Player Control Inputs: Player control inputs will be connected at the control panel. All the 1st player controls and player select lines on the wiring harness assembly are terminated with "Quick-Disconnects" which mate with the leaf switches of the controls furnished with the conversion kit.

The joystick terminations can be made by connecting the designated wires to corresponding switches on the 8-way joystick supplied in the kit.

"Up" - Blue wire at pin #13  
"Down" - Yellow wire at pin #17  
"Left" - Purple wire at pin #19  
"Right" - Brown wire at pin #15

The remaining wires for the action and player select buttons are to be terminated as follows:

"Throw" - Red wire at pin #22  
"1 Player" - Orange wire at pin #21  
"2 Player" - Green wire at pin #Y



The ground lead(s) for the controls are terminated and "daisy-chained" with eight (8) disconnects to be connected to the other contact of each leaf switch on the control panel.

The 2nd player control lines are unterminated and are only needed for a cocktail table installation, where two sets of controls are needed. Pin assignments can be found on page 8.

4. Coin Door & Inputs: Wiring for the coin inputs can be accomplished by following either of the diagrams on the bottom of page 8. Separate coin inputs are provided on pins #24 and #25 to allow for the selection of independent coin chute pricing (For options on price selection see page 2 - dip-switch B).

5. Audio Outputs: Begin by soldering the speaker lines to terminals S1 (-) and S2 (+) on the audio amplifier P.C.B., then connect the audio plug on the harness assembly (White 4 pin molex) into the socket (pl-4) on the amplifier unit.

NOTE: To avoid audio distortion, verify that the voltage to the amplifier is regulated at +12 Volts DC.

#### F.C.C. Warning:

"This equipment generates and uses radio frequency energy and if not installed and used properly, I.E., In strict accordance with the instructions manual may cause harmful interference to radio communications. It has been tested and found to comply with the limits for a CLASS A computing device pursuant to SUBPART J OF PART 15 OF F.C.C. RULES, which are designed to provide reasonable protection against such interference when operated in a commercial environment."











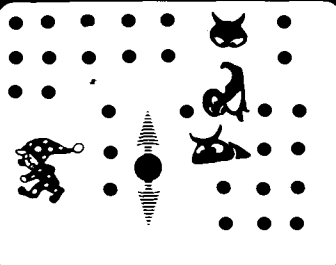
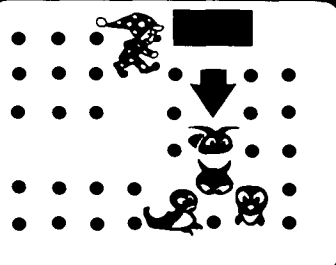





"Operation of this equipment in a residential area is likely to cause interference in which case the user at his own expense will be required to take whatever measures may be required to correct the interference."











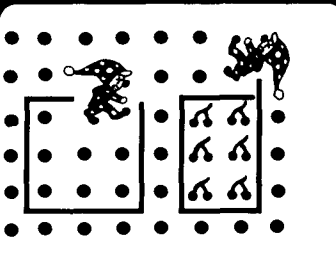





Mr. Do's Wild Ride P.C.B. is enclosed in a metal R.F. shield to meet the F.C.C. requirements stated above.

To comply with the ruling it is imperative that the R.F. shield is installed properly. After mounting, make sure that the cage is GROUNDED. With an Ohm meter, conduct a continuity test between the shield and ground, to verify proper installation. Enclosed in the conversion kit is an F.C.C. Warning Sticker. This decal **MUST** be placed and maintained on the exterior of the cabinet.

Under NO circumstances should this equipment be operated without the Printed Circuit Board properly installed in the R.F. shielding

## I. HOW TO PLAY

	<table border="1"> <thead> <tr> <th style="text-decoration: underline;">BOUNCES</th> <th style="text-decoration: underline;">POINTS</th> </tr> </thead> <tbody> <tr><td>0 =</td><td>500</td></tr> <tr><td>1 =</td><td>1000</td></tr> <tr><td>2 =</td><td>1500</td></tr> <tr><td>3 =</td><td>2000</td></tr> <tr><td>4 =</td><td>2500</td></tr> <tr><td>5 OR MORE =</td><td>3000</td></tr> </tbody> </table>	BOUNCES	POINTS	0 =	500	1 =	1000	2 =	1500	3 =	2000	4 =	2500	5 OR MORE =	3000		<table border="1"> <tr> <td style="text-align: center;">  1000 PTS                 </td> <td style="text-align: center;">  2500 PTS                 </td> </tr> <tr> <td colspan="2" style="text-align: center;">  4500 PTS                 </td> </tr> <tr> <td style="text-align: center;">  7000 PTS                 </td> <td style="text-align: center;">  10,000 PTS                 </td> </tr> </table>	 1000 PTS	 2500 PTS	 4500 PTS		 7000 PTS	 10,000 PTS
BOUNCES	POINTS																						
0 =	500																						
1 =	1000																						
2 =	1500																						
3 =	2000																						
4 =	2500																						
5 OR MORE =	3000																						
 1000 PTS	 2500 PTS																						
 4500 PTS																							
 7000 PTS	 10,000 PTS																						
<p>Bounce Powerball Off Walls to Hit Monsters and Score Higher Points.</p>	<p>Hint: Try Shorter Throws to the Side to Bounce More. Throw Only One at a Time. Hint: Powerball Will Miss Monsters Unless it is on Same Level As When Mr. Do! Threw It.</p>	<p>Log Will Roll. Crushing Monsters. When Released or Pushed by Mr. Do!</p>	<p>Hint: Line Up Monsters Chasing Mr. Do! For Most Points.</p>																				

	<table border="1"> <tr> <td style="text-align: center;">  10 PTS                 </td> <td style="text-align: center;">  20 PTS                 </td> </tr> <tr> <td colspan="2" style="text-align: center;">  30 PTS                 </td> </tr> <tr> <td style="text-align: center;">  40 PTS                 </td> <td style="text-align: center;">  50 PTS                 </td> </tr> </table>	 10 PTS	 20 PTS	 30 PTS		 40 PTS	 50 PTS	<h3>← HINTS / INSTRUCTIONS ↓</h3>
 10 PTS	 20 PTS							
 30 PTS								
 40 PTS	 50 PTS							
<p>Circle Dots to Change into Fruit. Collect Fruits and Dots to Get New Powerball.</p>	<p>Hint: It Takes Less Cherries Than Dots to Get New Powerball. Less Apples Than Cherries. Etc.</p>	<ul style="list-style-type: none"> <li>● Collect all dots or destroy all monsters to clear screen.</li> <li>● Monsters can be destroyed by throwing powerball or crushing with log.</li> <li>● Letter will appear somewhere among fruit. Collect letters to spell E-X-T-R-A and receive additional Mr. Do!</li> <li>● If diamond appears, collect diamond and receive free game.</li> </ul>						

## II. VARIOUS OPTIONAL SETTINGS

### DESCRIPTIONS OF DIP SWITCHES

- Dip Switch A

1. Number of Mr. Do! Given (SW1)

No. of Mr. Do!	SW1
3	OFF
5	ON

2. Special (SW2)

Given or not	SW2
Given	OFF
Not	ON

3. Game Style (SW3)

Style	SW3
Table	OFF
Upright	ON

4. Difficulty of EXTRA (SW4)

Difficulty	SW4
Easy	OFF
Difficult	ON

5. Screen Direction (SW5)

Direction	SW5
Forward	OFF
Reverse	ON

6. Automatic Renewal of Screen (SW6)

Automatic renewal	SW6
Made	OFF
Not made	ON

7. Difficulty of the Games (SW7, 8)

Difficulty	SW7	SW8
1 (Beginner)	OFF	OFF
2	OFF	ON
3	ON	OFF
4 (Advanced)	ON	ON

- Factory Settings

- Positions of Dip Switches

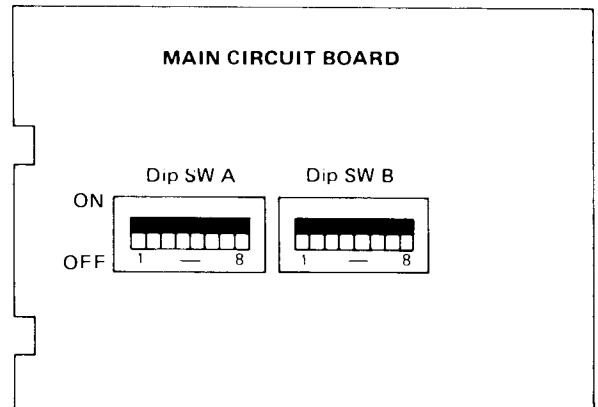

- Dip Switch B (Coin & Credit)

Coin	Credit	Left-side chute				Right-side chute			
		SW1	SW2	SW3	SW4	SW5	SW6	SW7	SW8
1	1	OFF	OFF	OFF	OFF	OFF	OFF	OFF	OFF
1	.2	OFF	OFF	OFF	ON	OFF	OFF	OFF	ON
1	3	OFF	OFF	ON	OFF	OFF	OFF	ON	OFF
1	4	OFF	OFF	ON	ON	OFF	OFF	ON	ON
1	5	OFF	ON	OFF	OFF	OFF	ON	OFF	OFF
2	1	OFF	ON	OFF	ON	OFF	ON	OFF	ON
2	3	OFF	ON	ON	OFF	OFF	ON	ON	OFF
3	1	OFF	ON	ON	ON	OFF	ON	ON	ON
3	2	ON	OFF	OFF	OFF	ON	OFF	OFF	OFF
4	1	ON	OFF	OFF	ON	ON	OFF	OFF	ON
1	1	ON	OFF	ON	OFF	ON	OFF	ON	OFF
1	1	ON	OFF	ON	ON	ON	OFF	ON	ON
1	1	ON	ON	OFF	OFF	ON	ON	OFF	OFF
1	1	ON	ON	OFF	ON	ON	ON	OFF	ON
1	1	ON	ON	ON	OFF	ON	ON	ON	OFF
Free play		ON	ON	ON	ON	ON	ON	ON	ON

#### Standard and Custom Price Settings

The game price set by a combination of dip SWs is displayed on the monitor when coin credit is 0.

- When the settings for right and left chutes are the same, "1 coin – 1 credit", "2 coins – 3 credits", etc. are displayed.
- When the settings for right and left chutes are provided differently, their respective contents can be displayed.



**DO! RUN RUN** has a self-test which locates any abnormalities within the circuitry should they occur. To enter the diagnostic self-test, turn power ON while depressing the 1 PLAYER START button.

**A. C.P.U. and MEMORY TEST**

★CRT displays:

CPU - 1	location S1
RAM OK	location H1, E1, and F1
ROM 1 OK	location P1
ROM 2 OK	location N1
ROM 3 OK	location L1
ROM 4 OK	location K1

★During the RAM test a sequence of high, middle, and low pitched tones (twelve each) should be heard. Upon passing and completion of the RAM test the tones should stop and the test should continue.

★CRT displays:

CPU - 2	location L7
RAM OK	location P7
ROM OK	location N7

## B. Color Sample Test:

This segment of the self-test is to aid in adjusting and identifying the color and intensity of the display to exit this portion of the diagnostic test, depress both 1 player and 2 player start buttons simotainiously.

★CRT displays:

		Color Sample Test								
("Red")	R.	□	□	□	□	□	□	□	□	★ 0 Thru 7 display varying intensities of each color, 0 being Black or the darkest to 7 being the lightest.
("Green")	G.	□	□	□	□	□	□	□	□	
("Blue")	B.	□	□	□	□	□	□	□	□	
("White")	W.	□	□	□	□	□	□	□	□	
		0	1	2	3	4	5	6	7	

## C. Switch Test:

Switch names are displayed on the left side of the screen, while input conditions will be displayed on the right side. When the switch is ON, "0" is displayed for input, and when it is OFF, "1" is displayed. Conduct test while turning each switch ON-OFF – the test will advance to the next step after a minute.

Switch name	Input condition
2P DOWN	1
LEFT	1
UP	0
RIGHT	1
1P DOWN	1
LEFT	1
UP	1
RIGHT	1
2P START	1
NOT USED	1
2P JUMP	1
FIRE	1
1P START	1
NOT USED	1
1P JUMP	1
FIRE	1
NOT USED	1
NOT USED	1

Switch name	Input condition
COIN LEFT	1
COIN RIGHT	1
PAUSE	1
SERVICE	1
TEST	1
TILT	1

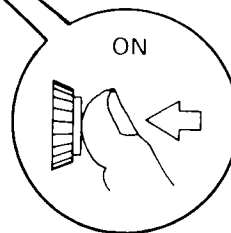

"0" will appear when pushing the pushbutton on the 1st player's side.



Dip switch A	1	0	1	1	0	1	1	1
" B	1	1	1	1	1	1	1	0

**D. TV Monitor Test:**

A cross hatch pattern will appear on the screen. Monitor adjustments can be made at this time.

Self-testing will stop at this point. Turn power ON again when you want to resume game play or execute the self-test again.

- In case you have found any abnormality as a result of the self-test, contact your local Universal U.S.A. Distributor.





**[1] Integrated Circuit**

Item No.	Q'ty	Description
74LS 00N	2	TTL
74LS 01	1	"
74LS 04	4	"
74LS 08	1	"
74LS 20	2	"
74LS 27	1	"
74LS 32	1	"
74LS 74	5	"
74LS 86	7	"
74LS138	3	"
74LS139	3	"
74LS157	6	"
74LS161	3	"
74LS244	2	"
74LS245	2	"
74LS257	4	"
74LS273	6	"
74LS283	3	"
74LS373	1	"
74LS374	4	"
74ALS04N	1	"
74ALS08	1	"
74S374N	1	"
Z80A	3	NMOS CPU (4MHz)
2764-300	8	NMOS 64K bits EP ROM (Access 300nsec)
27128-300	2	NMOS 128K bits ROM (Access 300 nsec)
N82S147	2	4096 bits Fuse ROM
TMS4164-200	16	64K DRAM
MB8128-150	5	NMOS 16K bits Static RAM (Access 150nsec)
MB8128-100	1	NMOS 16K bits Static RAM (Access 100nsec)
CF37201N	1	Custom Function
NE556	1	Timer
LM342N	1	Audio Amplifier
SN76489AN	4	Programable Sound Generator
TMS1025N2CL	2	CMOS
HD46505SP	1	CRTC
10D1	4	Diode
UA7805	1	Regulator

**[2] Capacitors**

Rating	Q'ty	Description
50PF50V	2	Ceramic Capacitor
220PF50V	1	"
390PF50V	3	"
0.01μF50V	5	"
0.1μF12V	25	"
4.7μF25V	1	ES Capacitor
10μF16V	1	"
47μF16V	2	"
470μF16V	1	"
1000μF16V	1	"

**[3] Resistors**

Rating	Q'ty	Description
22Ω	1	Carbon Solid
100Ω	1	"
200Ω	3	"
330Ω	6	"
390Ω	3	"
470Ω	2	"
820Ω	2	"
1KΩ	2	"
5.1KΩ	1	"
10KΩ	1	"
20KΩ	1	"
24KΩ	4	"
30KΩ	1	"
100KΩ	28	"
120KΩ	4	"
220KΩ	1	"
510KΩ	1	"
330 x 8	3	Resistor Array
1K x 8	2	"
10K x 8	2	"

**[4] Misc**

Name	Q'ty	Description
Dip SW	2	8 Elements Switch Array
X tal	1	9.828MHz
"	1	4.000MHz
20P	2	IC Socket
28P	10	"

This drawing provides standard information.  
Universal reserves the right to change without notice.



Fig-1



DO! RUN RUN HARNESS PIN ASSIGNMENT

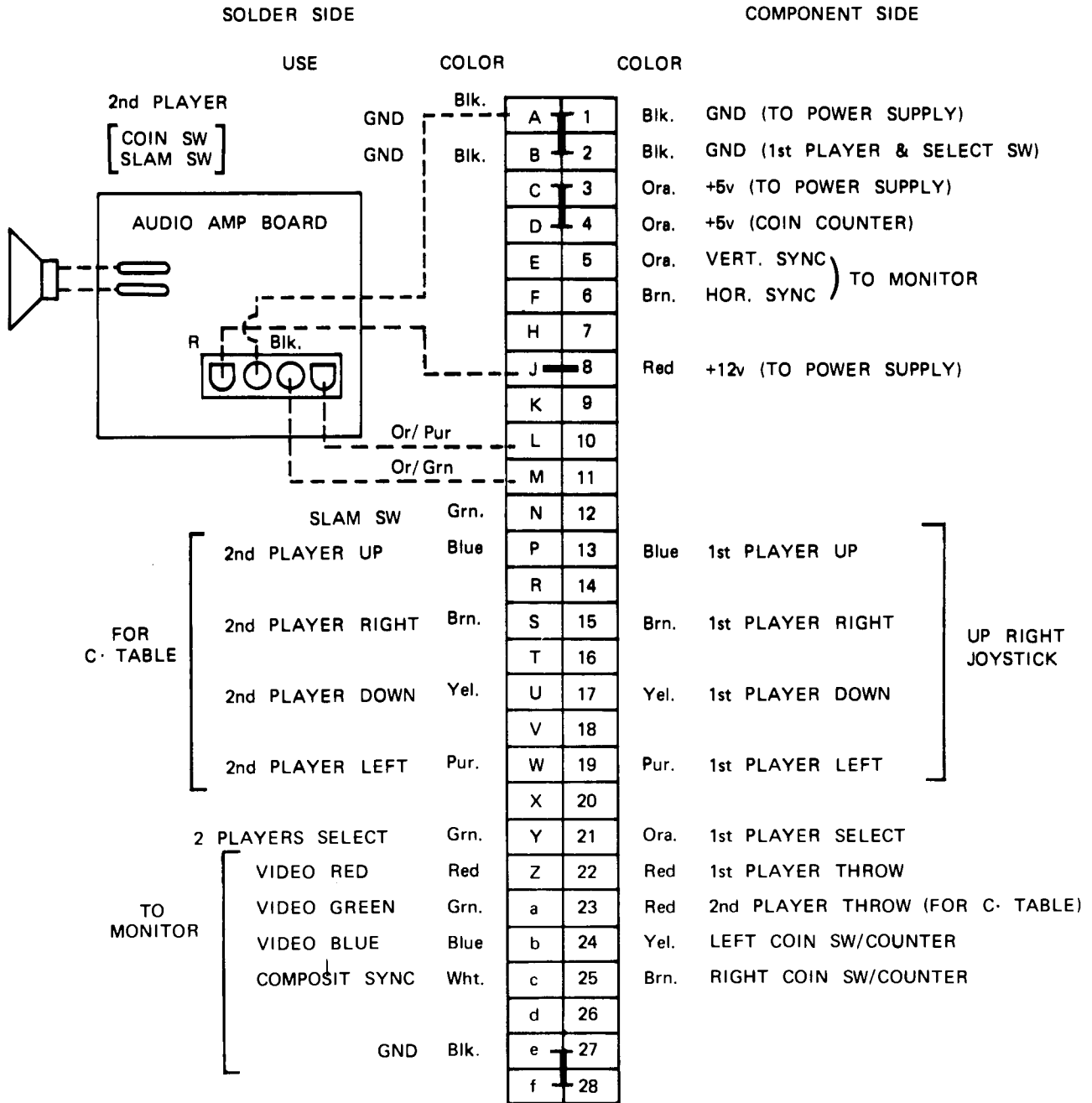

NOTE:

CONNECTION FOR USE WITH COIN METER

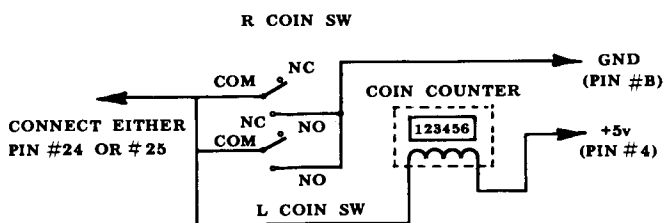

CONNECTION FOR USE WITHOUT COIN METER

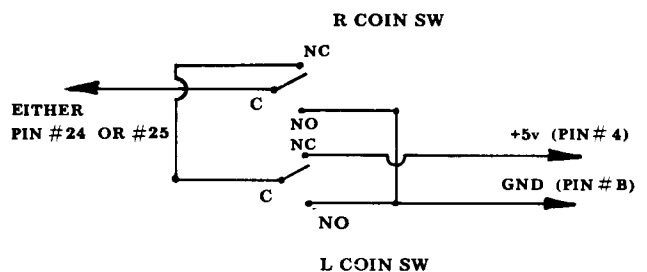
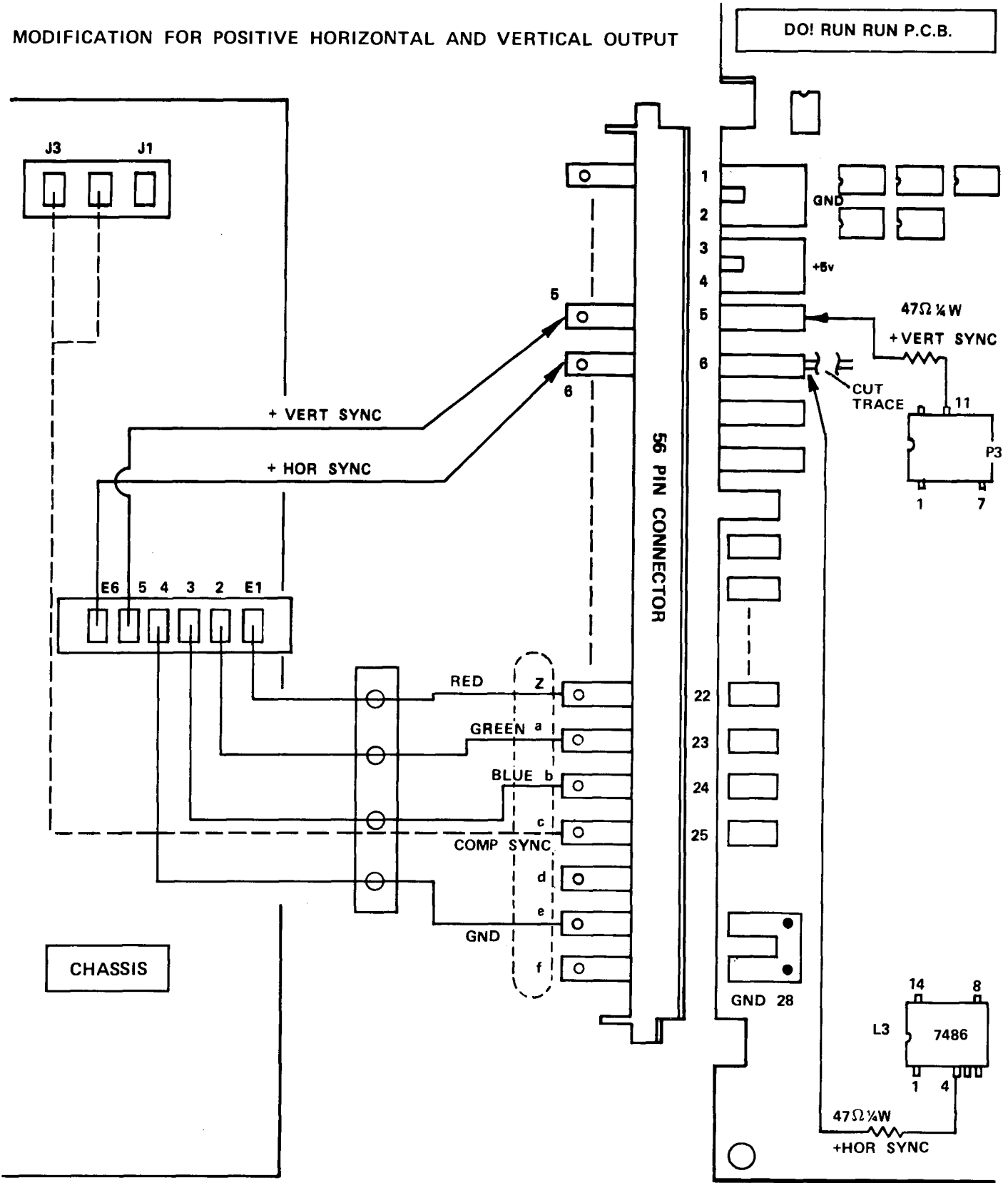

Fig-2

MODIFICATION FOR POSITIVE HORIZONTAL AND VERTICAL OUTPUT



\* BE SURE TO REMOVE COMP SYNC LINE WHEN INSTALLING THE POSITIVE INDEPENDANT SYNC LINES.

\* BEFORE ATTACHING THE JUMPER WIRE FOR THE POSITIVE HORIZONTAL SYNC SIGNAL TO PIN 6 OF THE CARD EDGE, ISOLATE PIN 6 BY CUTTING THE TRACE DIRECTLY BEHIND THE PAD.

Fig-3

## Control Panel Assessories And Layout

Diagram A.

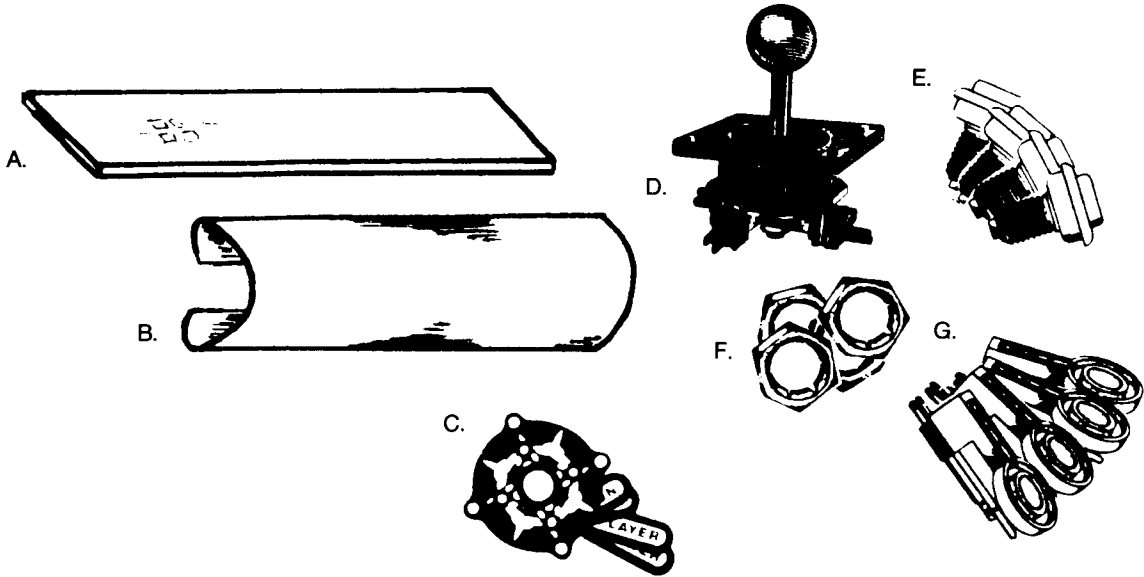

- A. Clear Plex
- B. Polycarbonate Overlay
- C. Indication Decals
- D. 8-Way Joystick
- E. Buttons
- F. Pal Nuts
- G. Button Housings W/Leaf Switch

Diagram B.

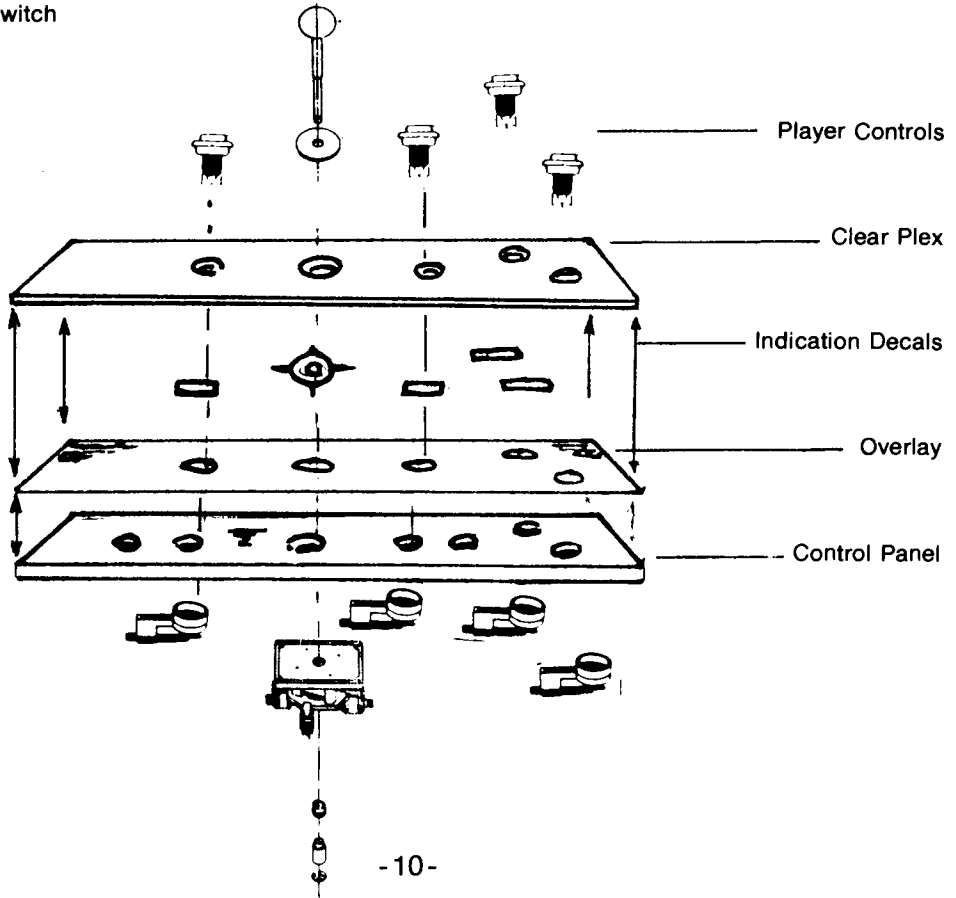

# UNIVERSAL

Fig-4

## SOUND AMPLIFIER DIAGRAM AND PARTS LOCATION

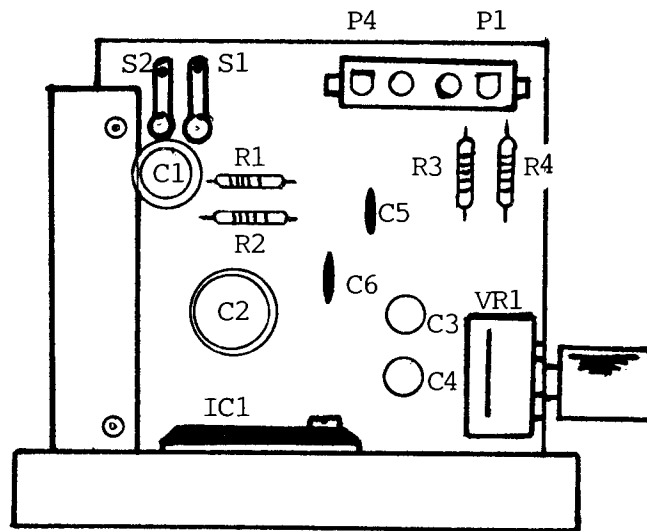
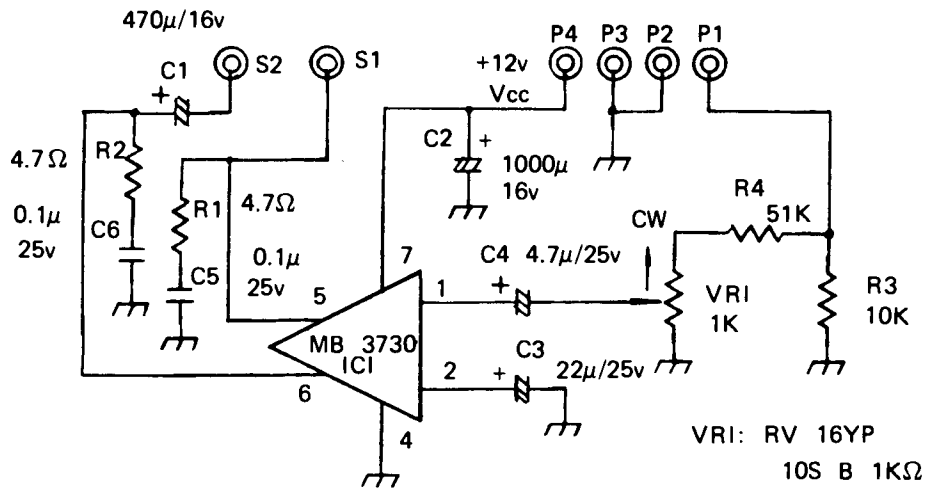

SOUND AMPLIFIER UNIT



# Do! Run Run

T.M.

## COPYRIGHT INFRINGEMENT POLICY

Universal U.S.A., Inc. holds the sole proprietary interest for the manufacture of the Do! Run Run game, and has registered a copyright and trademark with the United States Copyright Office.

Due to Do! Run Run's excellent earnings report, there may be those interested in illegally reproducing this game.

**LET THERE BE NO MISTAKE!** Universal U.S.A., Inc. will protect its proprietary rights by taking any and all legal action necessary against any person or company that manufactures, sells, distributes, and/or operates any game which violates these exclusive rights of the Do! Run Run video game. Any violation whatsoever will be prosecuted to the fullest extent of the law.

Authenticity of any Do! Run Run game can be verified by calling 1-(800) 538-7538 during regular business hours.



Universal U.S.A., Inc.  
3250 Victor Street  
(408) 727-4591 Santa Clara, CA 95050 TELEX: 172247

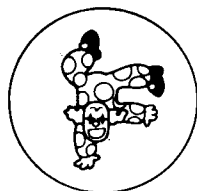

**Head Office:**

**Universal Co., Ltd.**

1-7-7, Nihonbashi Horidome-cho, Chuo-ku, Tokyo 103, Japan  
Phone: 03-661-6004, 6005 Cable: UNMANIFACT  
Telex: J27348 (UNICO)

**Universal U.S.A. Inc.**

3250 Victor Street, Santa Clara, California 95050, U.S.A.  
Phone: 408-727-4591-5 Telex: 172247 (UNI USA SNTA)  
Main Line of Business: Development, manufacture, sales, and  
exports & imports of amusement machines

**European Office**

81 Tottenham Court Road, London W1A 1EY  
Phone: 01-631-1713 Telex: 892989 ELCOIN