

LICENSED BY KONAMI



Instruction Manual

JUNO FIRST (GAME GV-122) INSTRUCTION MANUAL

TABLE OF CONTENTS

SEC.		PAGE
I.	INSTALLATION	1
II.	INITIALIZATION	3
III.	GAME OPERATION	3
IV.	GAME PLAY AND SCORING	4
V.	SOUND	6
VI.	GAME ADJUSTMENTS/OPTIONS	6
VII.	GENERAL INFORMATION	7
VIII.	WIRING AND SCHEMATIC DIAGRAMS	9
IX.	PARTS INFORMATION	23

**WELLS GARDNER MONITOR,
SERVICE AND OPERATION MANUAL (Attached)**

WARNING: This equipment generates, uses, and can radiate radio frequency energy and if not installed and used in accordance with the instructions manual, may cause interference to radio communications. It has been tested and found to comply with the limits for a Class A computing device pursuant to Subpart J of Part 15 of FCC Rules, which are designed to provide reasonable protection against such interference when operated in a commercial environment. Operation of this equipment in a residential area is likely to cause interference in which case the user at his own expense will be required to take whatever measures may be required to correct the interference."

NOTICE

WARRANTY INFORMATION IS LOCATED ON THE INSIDE BACK COVER.

FOR SERVICE, CALL TOLL FREE: 1-800-323-9121; (ILLINOIS) 1-800-942-1620

I. INSTALLATION

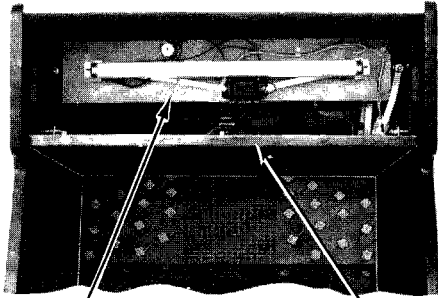

MA-376 ILLUMINATION ASSY.

MA-459 SPEAKER ASSY.

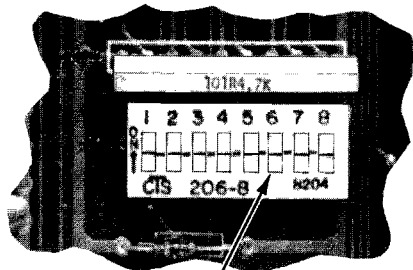

GAME ADJUSTMENT SWITCHES (PART OF PWB-1 LOGIC BOARD)

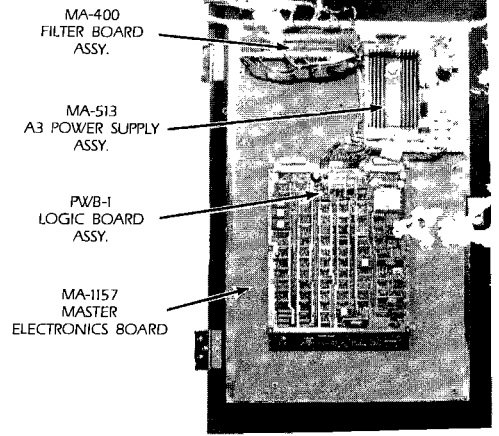

MA-400 FILTER BOARD ASSY.

MA-513 A3 POWER SUPPLY ASSY.

PWB-1 LOGIC BOARD ASSY.

MA-1157 MASTER ELECTRONICS BOARD

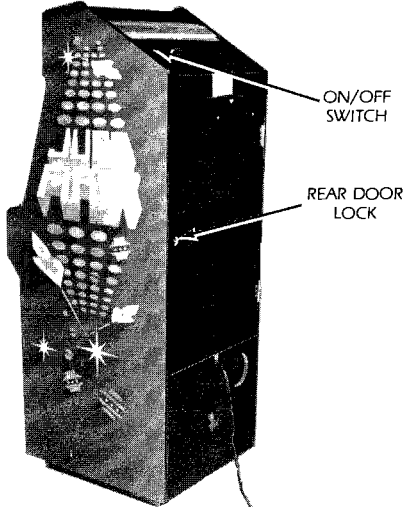

ON/OFF SWITCH

REAR DOOR LOCK

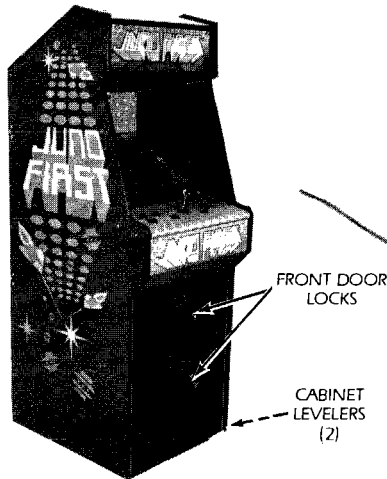

FRONT DOOR LOCKS

CABINET LEVELERS (2)

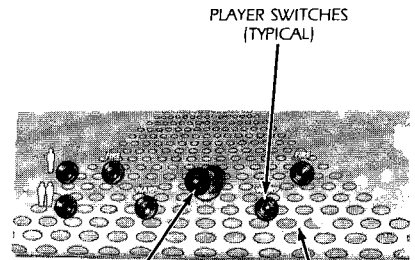
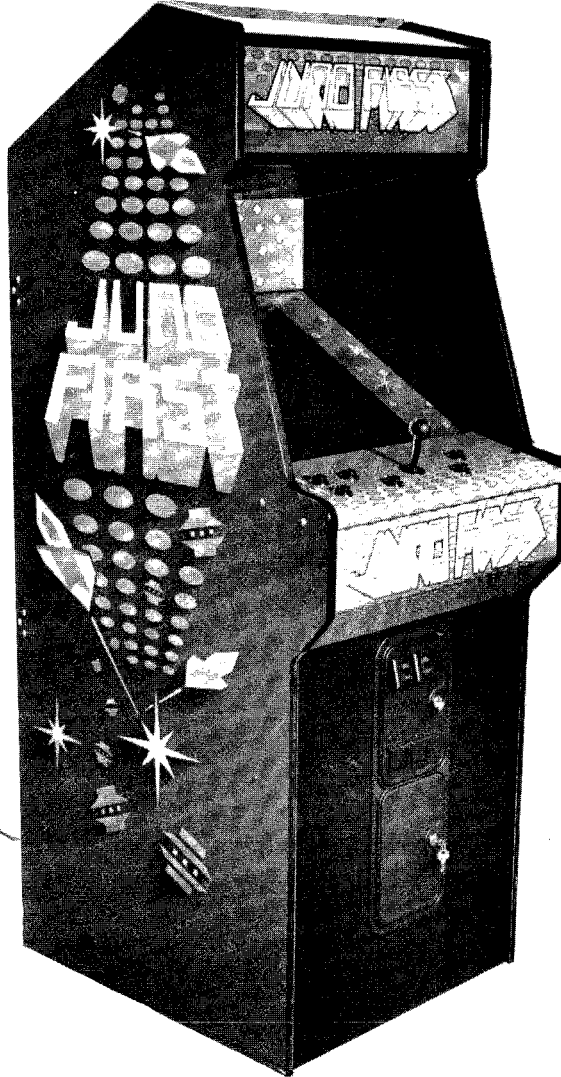

PLAYER SWITCHES (TYPICAL)

C-23189 JOYSTICK ASSY.

MA-1137 CONTROL PANEL ASSY.

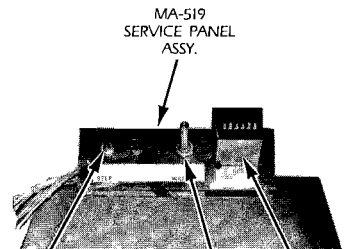

MA-519 SERVICE PANEL ASSY.

STEP/TEST SWITCH

VOLUME CONTROL

COIN MEI

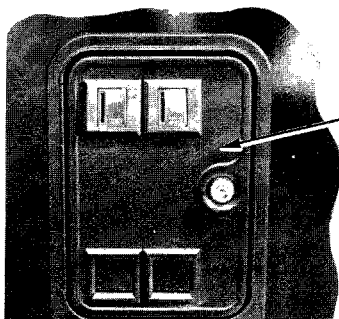

MA-399 FRONT DOOR ASSY.

COIN SWITCH #1

COIN SWITCH #2

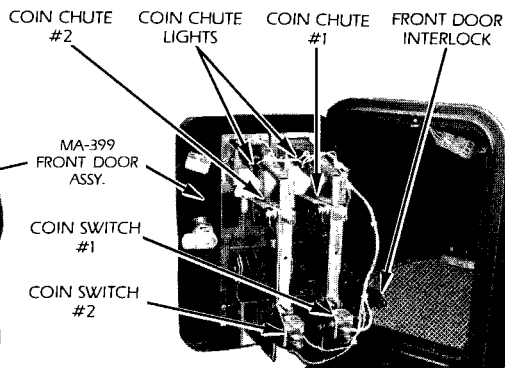

COIN CHUTE #2

COIN CHUTE LIGHTS

COIN CHUTE #1

FRONT DOOR INTERLOCK

MA-375 BOTTOM PANEL ASSY.

A12J2

SERVICE OUTLET

F1 PRIMARY POWER FUSE

F3 MONITOR FUSE

F4 9V AC FUSE

BRIDGE RECTIFIERS

F5 15V AC FUSE

F2 6.3V AC FUSE

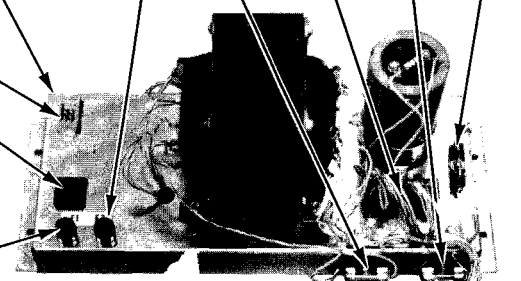

I. INSTALLATION

A. SET—UP

1. Carefully inspect the exterior of the game for any damage which might have occurred during shipment.
2. Unlock and open the rear cabinet door.
3. Check that all plug in connectors are seated firmly. The connectors are keyed so they will only go in one way.
4. Remove the binding strap from the line cord, and install the line cord plate in the groove provided (see photo).
5. Cabinet levelers (2) are stored within the cash box for shipping purposes. Install and adjust as necessary.

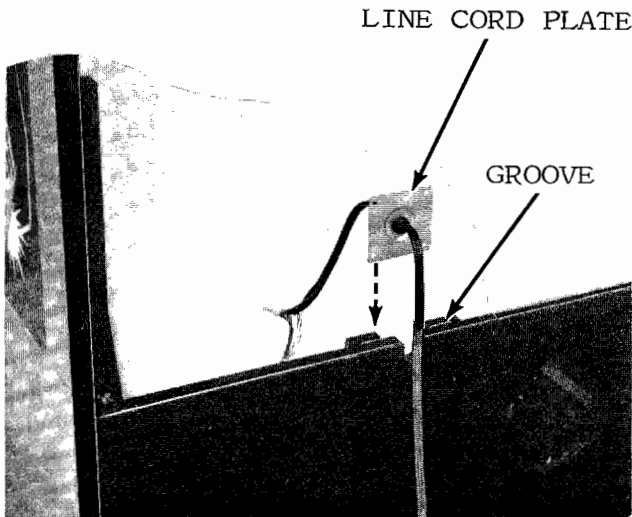

B. CHECK-OUT

1. Check that all cables are free of moving parts.
2. Check for any loose wires.
3. Check for loose solder or foreign matter on switches and power supply assemblies.
4. Be certain all fuses are seated firmly.
5. Be sure transformer wiring corresponds to the supply voltage.
6. Refer to section VI to make all the necessary game adjustments.
7. Reassemble the game.
8. Plug the line cord into a properly grounded 3-wire receptacle ONLY!!

C. CONTROL PANEL REMOVAL

1. Unplug the game.
2. Unlock and open the coin chute door.
3. Reach in through the coin chute door and remove the wing nut and flat washer from each of the two carriage bolts which secure the control panel to the game. Unlatch the control panel latch at the top center of the panel. Note where the latch strike plate is located. Remove the carriage bolts.
4. Pull the control panel back, grasp it at the front edge as far back as it will go (approximately 1/4").
5. Raise the front of the control panel approximately one inch above its supports and lift the entire assembly high enough to disconnect plug A9J2/A9P2.
6. Remove the entire control panel assembly from the game.
7. The joystick's and leaf-switches are now accessible for removal or cleaning.
8. For reassembly, reverse the above procedure.

D. MONITOR REMOVAL

1. Unplug the game.
2. Perform the control panel assembly removal procedure (Section C).
3. Unlock and open the rear cabinet door.
4. NOTE: The color monitor contains HIGH VOLTAGES delivering LETHAL quantities of energy. Do not attempt to service the monitor until you have shorted the anode plug on the picture tube to ground.
5. Disconnect the video plug A17J1, the monitor power supply plug A12J3/A12P3 and the ground wire from the monitor chassis.
6. From the rear of the game, remove the one nut and one washer from each of the four carriage bolts used to secure the monitor to the platform.
7. Remove the monitor from the rear of the game, being careful to clear all cables from the CRT neck.
8. For reassembly, reverse the above procedure.

I. INSTALLATION, II. INITIALIZATION, III. GAME OPERATION

I. INSTALLATION

E. SPEAKER ASSEMBLY AND MARQUEE REMOVAL

1. Unplug the game.
2. Unlock and open the back door.
3. Unplug the A15-J1/P1 connector.
4. Unlatch the two latches on the rear of the Speaker Assembly Panel located inside the back door above the monitor.
5. On the front of the game, pull down on the lower molding under the marquee. The Speaker Assembly will lower to allow removal of the marquee.
6. Remove the marquee by lifting it upward out of its track. The Speaker Assembly and Illumination Assembly are now accessible for servicing.
7. Tilt the front of the Speaker Assembly downward while lifting the center upward.

Pull the assembly straight out to remove. Be careful not to pinch the Speaker Assembly cable.

8. For reassembly, reverse the above procedure. When replacing the marquee:
 - a. Tilt the front of the Speaker Assembly downward.
 - b. Place the bottom of the marquee in the lower molding track on the front of the assembly.
 - c. Apply slight pressure with your thumbs to the lower left and right corners of the marquee.
 - d. Slowly raise the Speaker Assembly until the top of the marquee is in place in the upper track in the top molding.
 - e. Be certain to reconnect the A15-J1/P1 connector and relatch the rear assembly latches.

II. INITIALIZATION

TURN GAME ON

Immediately, the coin chute lamps and the speaker marquee lamp will turn on.

- B. The playing field cycles through the following:

1. High Game to Date screen
2. Point values
3. Game play cycle

AFTER A TEN SECOND DELAY

- A. The attract mode appears on the screen.

III. GAME OPERATION

A. GAME START

1. Insert coins into coin chute.
 - a. Coin chute tune is played.
 - b. Total credits are displayed on screen.
2. Press one or two player button to start game.
 - a. Total Credits are decreased by one.
 - b. Game initializes.

B. FIRST PLAYER

1. The first player's score displays a zero.
2. The other player's display will be blank.

C. SECOND PLAYER

1. Additional player is indicated by zeroes in the second player's display.

D. SHIPS/EXTRA SHIPS

1. Each player will begin with three Ships (dependent on Option/Parameter settings).
2. Extra Ships are earned by achieving certain score levels (dependent on Option/Parameter settings).

IV. GAME PLAY AND SCORING

HOW TO PLAY

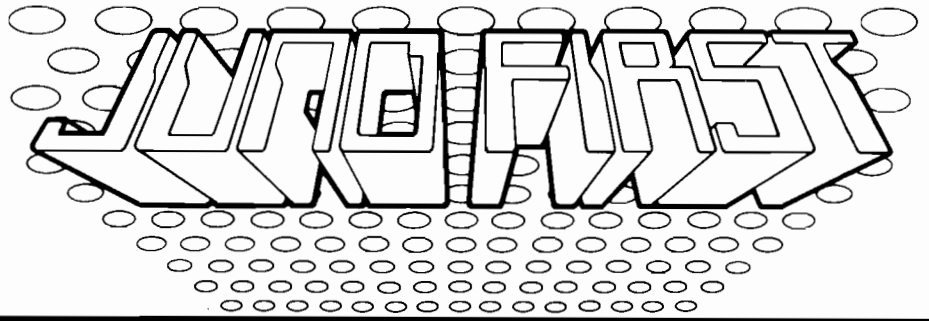

LICENSED BY KONAMI

CONTROL PANEL

The joystick controls the players ships direction of flight. The ship can be moved in one of eight directions. The FIRE button shoots lasers in the forward direction. The WARP button will cause the ship to warp momentarily in order to avoid enemy fire. The one and two player select buttons are also located on the panel.

SCREEN DISPLAYS

The top of the screen displays the first players score, number of ships remaining, the current wave of game play and the second players score (2 players). The second line across the top of the screen displays the time (initially 99 seconds) and the remaining number of warps available.

GAME PLAY

The game starts with the players ship flying towards the horizon where enemy aliens are seen. The player must avoid their bombs while shooting lasers with the FIRE button. There are two types of enemy bombs throughout the game. The aliens can fire either straight bombs or smart bombs. Smart bombs can be destroyed by the players lasers. If not destroyed, the smart bomb will follow the players ship around the screen. It is advantageous to destroy the aliens as quickly as possible because their longevity allows them to

become faster and more dangerous to the players ship. If the timer is allowed to decrement to zero the player loses his ship.

BONUS PERIOD

During each wave, a space capsule containing an enemy astronaut momentarily appears. For bonus points, the player must hit the capsule with laser fire, which dislodges the enemy astronaut, causing him to float freely in space. The player can then capture the enemy astronaut with the ship. At this point the screen will change colors and the enemy aliens stop shooting at the players ship. The player can now shoot as many of the aliens as possible for bonus points until the screen changes back to the original color. See ROUND PROGRESSIONS. The player must shoot the space capsule quickly since it appears only for a brief period of time.

BONUS

At the end of each wave, another bonus is awarded. The bonus for completing the wave is multiplied by a bonus multiplier to determine the total bonus. The bonus multiplier is determined by the amount of time remaining on the timer when the wave is completed. See BONUS PROGRESSIONS.

IV. GAME PLAY AND SCORING

ROUND PROGRESSIONS (BONUS PERIOD)

WAVE	CAPTURE ENEMY ASTRONAUT	FIRST ALIEN SHIP DESTROYED	*EACH SUCCESSIVE ALIEN SHIP DESTROYED
1	800	400	Increments by 200 Points Per Alien Ship
2	800	600	
3	Formation Attack		
4	1600	1000	
5	1600	1200	Increments by 200 Points Per Alien Ship
6	Formation Attack		
7	3200	1600	
8	3200	1800	
9	800	2000	Increments by 200 Points Per Alien Ship
10	800	2200	
11	Formation Attack		
12	1600	2600	
13	1600	2800	Increments by 200 Points Per Alien Ship
14	Formation Attack		
15	3200	3200	
16	3200	3200	

*The bonus value for Each Successive Alien Ship Destroyed has a base value equal to 200 points above the first alien destroyed.

The maximum successive bonus per alien ship is 3200 points.

BONUS PROGRESSIONS

TIME REMAINING— END OF WAVE (SECONDS)	BONUS MULTIPLIER	END OF WAVE BONUS	WAVE
1-5	0	100	1
6-10	1	100	2
11-15	2	200	3
16-20	3	200	4
21-25	4	300	5
26-30	5	300	6
31-35	6	400	7
36-40	7	400	8
41-45	8	400	9
46-50	9	400	10
51-55	10	400	11
56-60	11	400	12
61-65	12	400	13
66-70	13	400	14
71-75	14	400	15
76-80	15	400	16
81-85	16	400	17
86-89	17	400	18

The bonus awarded at the end of each wave is equal to the End of Wave Bonus multiplied by the Bonus Multiplier which is determined by the amount of time remaining on the timer when the wave is completed.

V. SOUND, VI. GAME ADJUSTMENTS / OPTIONS

V. SOUND

The Sound Board installed in this game has been programmed for Sound only.

VI. GAME ADJUSTMENTS/OPTIONS

A. LOGIC BOARD SWITCH ADJUSTMENTS

**DIP SWITCH 1 (DSW1)
Coin Chute 1**

SW	4	3	2	1	COIN	CREDIT
OFF	OFF	OFF	OFF	1	1	
		OFF	ON	1	2	
		ON	OFF	1	3	
		ON	ON	1	4	
OFF	ON	OFF	OFF	1	5	
		OFF	ON	1	6	
		ON	OFF	1	7	
		ON	ON	2	1	
ON	OFF	OFF	OFF	2	3	
		OFF	ON	2	5	
		ON	OFF	3	1	
		ON	ON	3	2	
ON	ON	OFF	OFF	3	4	
		OFF	ON	4	1	
		ON	OFF	4	3	
		ON	ON	FREE PLAY		

Coin Chute 2

SW	8	7	6	5	COIN	CREDIT
OFF	OFF	OFF	OFF	1	1	
		OFF	ON	1	2	
		ON	OFF	1	3	
		ON	ON	1	4	
OFF	ON	OFF	OFF	1	5	
		OFF	ON	1	6	
		ON	OFF	1	7	
		ON	ON	2	1	
ON	OFF	OFF	OFF	2	3	
		OFF	ON	2	5	
		ON	OFF	3	1	
		ON	ON	3	2	
ON	ON	OFF	OFF	3	4	
		OFF	ON	4	1	
		ON	OFF	4	3	
		ON	ON	INVALID		

DIP SWITCH 2 (DSW2)

SW	2	1	NUMBER OF SHIPS	
*	OFF	OFF	3	
	OFF	ON	4	
	ON	OFF	5	
	ON	ON	256	
SW	3		TABLE/UPRIGHT	
			OFF	Table
			ON	Upright
SW	4		NOT USED	
SW	7	6	5	DIFFICULTY LEVEL
*	OFF	OFF	OFF	1 (easy)
	OFF	OFF	ON	2
	OFF	ON	OFF	3
	OFF	ON	ON	4
	ON	OFF	OFF	5
	ON	OFF	ON	6
	ON	ON	OFF	7
	ON	ON	ON	8 (difficult)
SW	8		SOUND-ATTRACT MODE	
			OFF	No Sound
			ON	Sound

*INDICATES RECOMMENDED SETTINGS

B. SOUND ADJUSTMENTS

The audio output is controlled by the potentiometer mounted on the Service Panel Assembly (located inside the coin mechanism door) as well as the limiting potentiometer (VR200) located on the PWB1 Logic Board.

Turning the potentiometers counter-clockwise will decrease the volume. Turning it clockwise will increase the volume.

C. MONITOR ADJUSTMENTS

Normally, few if any adjustments are required for proper monitor operation. However, after any major repairs to the monitor chassis refer to the attached monitor manual.

VII. GENERAL INFORMATION

A. PRINTED CIRCUIT BOARDS ARE DESIGNATED AS FOLLOWS:

PWB1 Logic Board Assy.
A3 Power Supply Assy.
A8 Filter Board Assy.

B. WIRE COLORS ARE SHOWN AS NUMBERS:

0 Black	5 Green
1 Brown	6 Blue
2 Red	7 Purple
3 Orange	8 Slate
4 Yellow	9 White

For example, 688 is a BLUE- SLATE-SLATE striped wire.

C. FUSES

BOTTOM PANEL

F1	Primary Power	4 Amp SLO-BLO
F2	6.3 VAC	3 Amp SLO-BLO
F3	Monitor	2 Amp SLO-BLO
F4	9 VAC	10 Amp SLO-BLO
F5	15 VAC	1 Amp SLO-BLO

POWER SUPPLY ASSY. (A3)

F11	+5VDC Source	6¼ Amp SLO-BLO	
F21	PWB1 Logic Board Assy.	+12VDC	2.5 Amp SLO-BLO
F31	PWB1 Logic Board Assy.	-5VDC	¼ Amp SLO-BLO
F32	PWB1 Logic Board Assy.	-5VDC	¼ Amp SLO-BLO
F41	Coin Meter	+20VDC	1 Amp SLO-BLO

VII. GENERAL INFORMATION

POWER SUPPLY SPECIFICATIONS

LOCATION	VOLTAGE*	PROTECTION
Logic Board Assy.	+5VDC	Voltage adjustable. 6 Amps over-voltage protection and fused for over-current protection.
Logic Board Assy.	+12VDC	1.5 Amps fused for over-current protection. The reference for this circuit is a 1N4742A +12VDC Zener controlling the base of an emitter follower pass transistor.
Logic Board Assy.	-5VDC	20 milliamps fused for over-current protection. The minus 5 volt supply is the 7905 IC regulator.
Coin Meter	+20VDC	Full wave rectified unfiltered voltage, fused for over-current protection.
Coin Chute Lights	+4.5VDC	Full wave rectified unfiltered voltage, fused for over-current protection.
Monitor and Marquee	100VAC or 115VAC, 60HZ	Isolated, fused AC voltage.

VIII. WIRING AND SCHEMATIC DIAGRAMS, PARTS LISTS

TABLE OF CONTENTS

	PAGE
LOGIC BOARD ASSY.	
COMPONENT LOCATION AND SCHEMATIC DIAGRAM (SHEET 1 OF 2)	11
COMPONENT LOCATION AND SCHEMATIC DIAGRAM (SHEET 2 OF 2)	14
POWER SUPPLY ASSY. (A3)	
COMPONENT LOCATION AND PARTS LIST	17
SCHEMATIC DIAGRAM	18
PRIMARY POWER/FILTER BOARD ASSY./ INTERCONNECTION DIAGRAM	20

VIII. WIRING AND SCHEMATIC DIAGRAMS, PARTS LISTS

The following parts list contains unique parts used on the PWB-1 Logic Board Assy. All other components on the PWB-1 Logic Board Assy. are standard parts.

DESIGNATION	PART NO.
74LS293	XO-717
74LS375	XO-718
74LS257	XO-719
7489	XO-88
74153	XO-721
Konami 1 CPU	XO-741
M14081	XO-725
M14082	XO-740
M14083	XO-726
K-8207	XO-727
74LS14	XO-728
74LS21	XO-729
Z80 CPU	XO-730
M5L8039-8 CPU	XO-731
AY-3-8910	XO-733
LA4460	XO-732
MSM4066	XO-734
74LS85	XO-735
74LS393	XO-736
2SA697	XO-722
2SC2320	XO-723
1S1588	XO-724

VIII. WIRING AND SCHEMATIC DIAGRAMS, PARTS LISTS

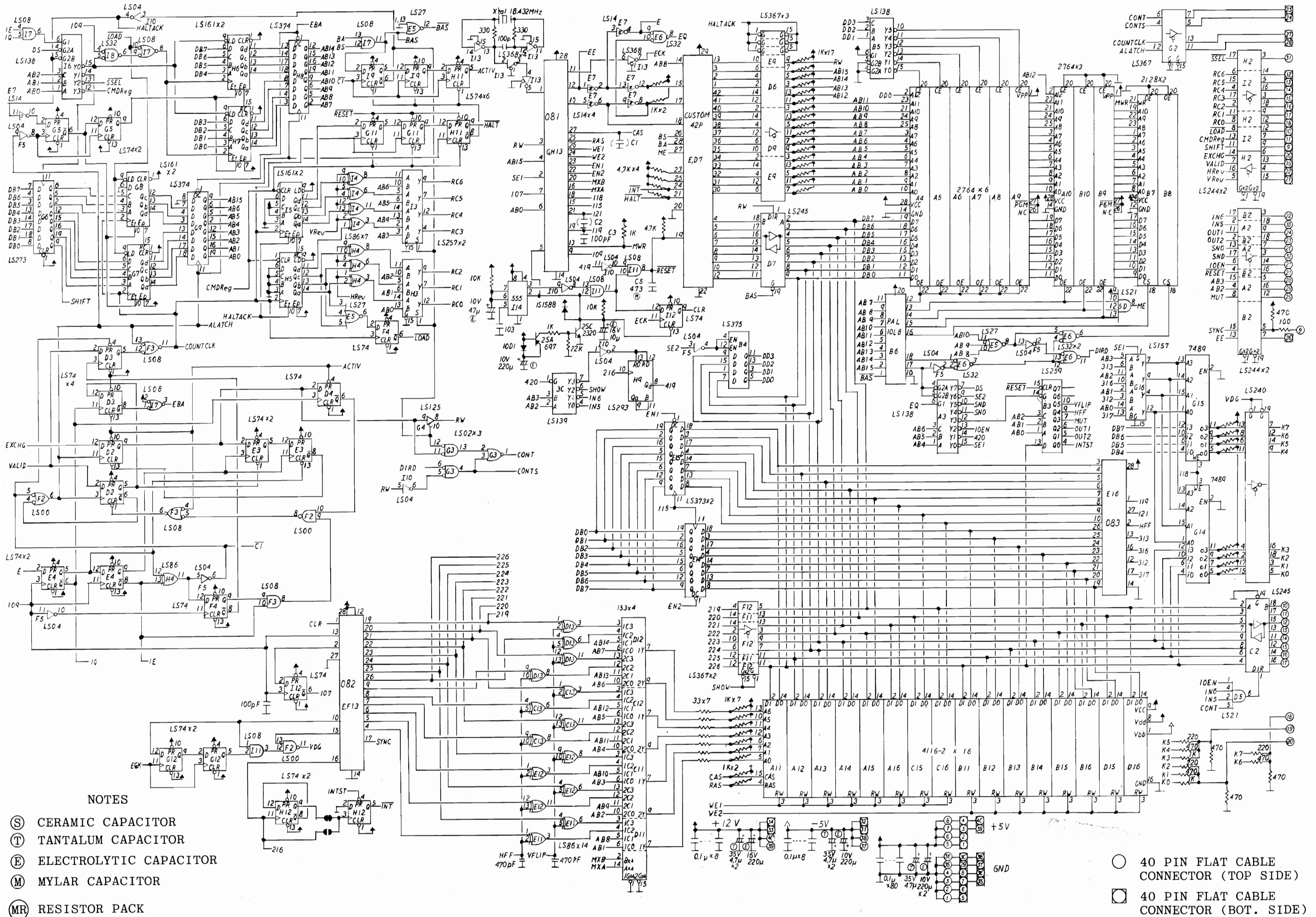

NOTES

- Ⓢ CERAMIC CAPACITOR
- Ⓣ TANTALUM CAPACITOR
- ⓔ ELECTROLYTIC CAPACITOR
- Ⓜ MYLAR CAPACITOR
- ⓂⓇ RESISTOR PACK

- 40 PIN FLAT CABLE CONNECTOR (TOP SIDE)
- ◻ 40 PIN FLAT CABLE CONNECTOR (BOT. SIDE)

VIII. WIRING AND SCHEMATIC DIAGRAMS, PARTS LISTS

POWER SUPPLY ASSY. (A3), COMPONENT LOCATION

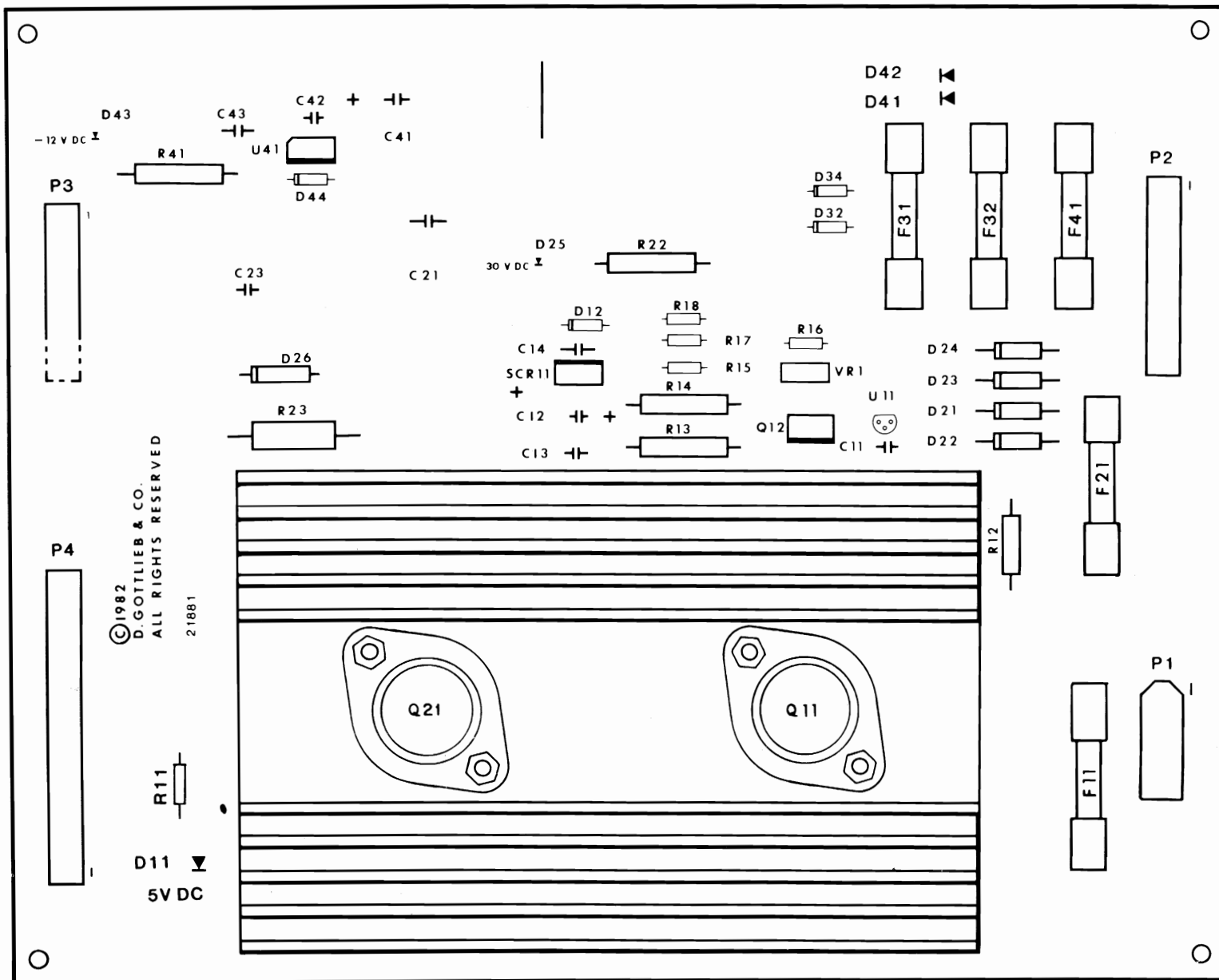

POWER SUPPLY ASSY. (A3), PARTS LIST

REFERENCE	DESCRIPTION	PART NO.	REFERENCE	DESCRIPTION	PART NO.
	Power Supply Assy.	MA-513	P2	Connector, 10 PIN	XO-531
C11, C42	Capacitor, 01 mfd., 50V	XO-229	P3	Connector, 7 PIN	XO-526
C12	Capacitor, 100UF, 16V	XO-235	P4	Connector, 16 PIN	XO-372
C13, C23	Capacitor, 0.1UF, 100V	XO-234	Q11	Transistor, PNP, 2N5879	XO-323
C14, C43	Capacitor, 0.2UF, 16V	XO-205	Q12	Transistor, NPN, TIP31B	XO-641
C21	Capacitor, 2200UF, 75V	XO-132	Q21	Transistor, NPN, 2N3055	XO-301
C41	Capacitor, 470UF, 35V	XO-284	R11	Resistor, 470 OHM, 5% 1/2W	XO-55
D11, D25	Diode, Light Emitting MV-5752	XO-270	R12	Resistor, 100 OHM, 5% 1W	XO-137
D43	Diode, Zener, 5.6V, 5%, 1W, 1N4734A	XO-255	R13, R14	Resistor, 12 OHM, 5% 2W	XO-138
D12	Diode, Zener, 12V, 5%, 1W, 1N4742A	XO-257	R15	Resistor, 200 OHM, 5% 1/4W	XO-143
D21-D24	Diode, 1N5401	XO-263	R16	Resistor, 180 OHM, 5% 1/4W	XO-24
D26	Diode, Zener, 12V, 5%, 1W, 1N4742A	XO-257	R17	Resistor, 100 OHM, 5% 1/4W	XO-28
D32, D34	Diode, 1N4004	XO-254	R18	Resistor, 20 OHM, 5% 1/4W	XO-29
D41, D42, D44	Diode, 1N4004	XO-254	R22	Resistor, 1.8KOHM, 5% 2W	XO-135
F11	Fuse, 6 1/4 AMP SLO-BLO	EL-8	R23	Resistor, 820 OHM, 5%, 2W	XO-706
F21	Fuse, 2 1/2 AMP SLO-BLO	EL-21	R41	Resistor, 750 OHM, 5% 1W	XO-136
F31, F32	Fuse, 1/4 AMP SLO-BLO	EL-5	SCR11	Silicon Controlled Rectifier	XO-131
F41	Fuse, 1 AMP SLO-BLO	EL-6	U11	Diode, Programmable Zener TL431	XO-272
P1	Connector, 4 PIN	PS-87	U41	Voltage Regulator +5V, LM 320	XO-572
			VR1	Potentiometer, 100 OHM	XO-134

VIII. WIRING AND SCHEMATIC DIAGRAMS, PARTS LISTS

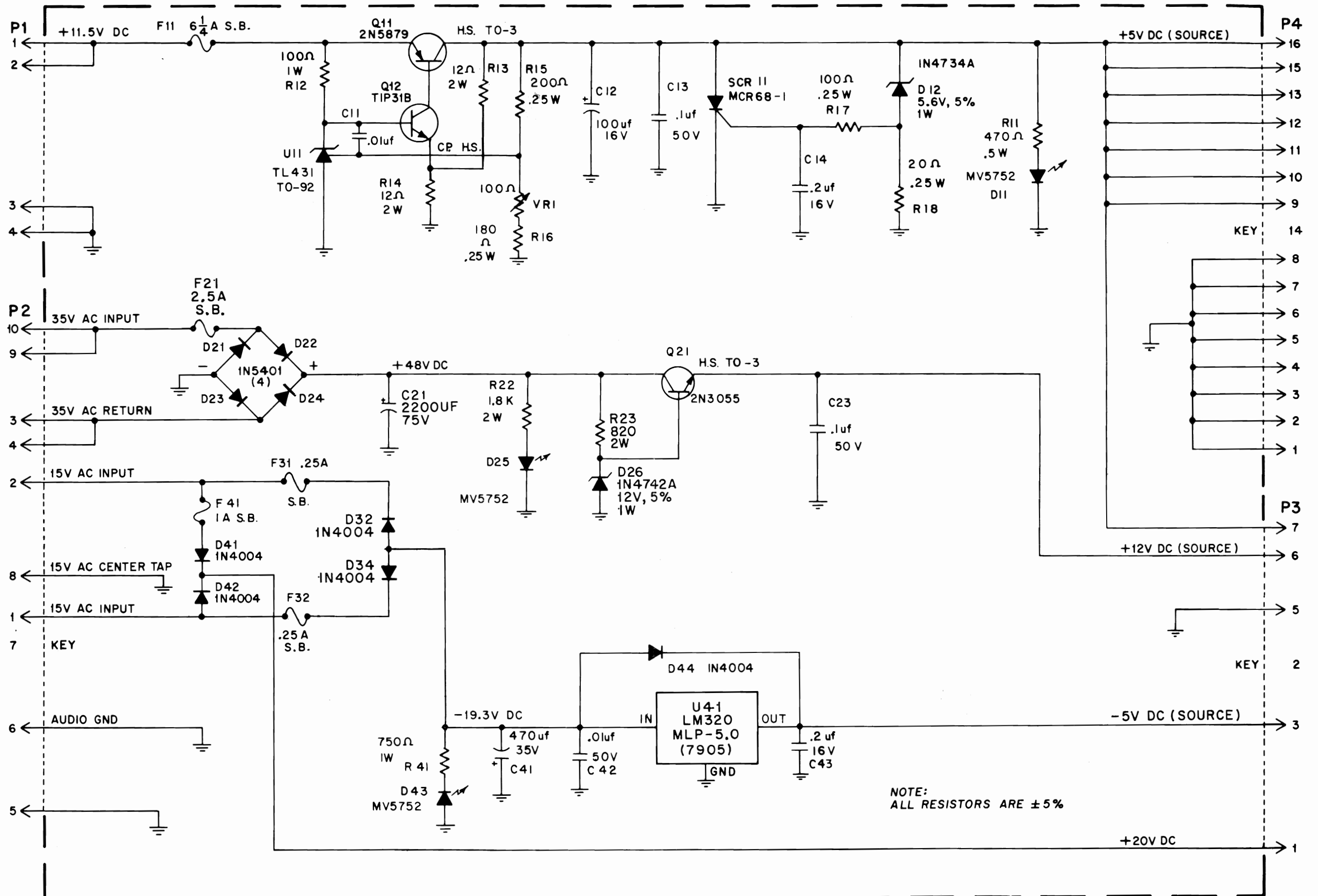

POWER SUPPLY ASSY. (A3), SCHEMATIC DIAGRAM

VIII. WIRING AND SCHEMATIC DIAGRAMS, PARTS LISTS

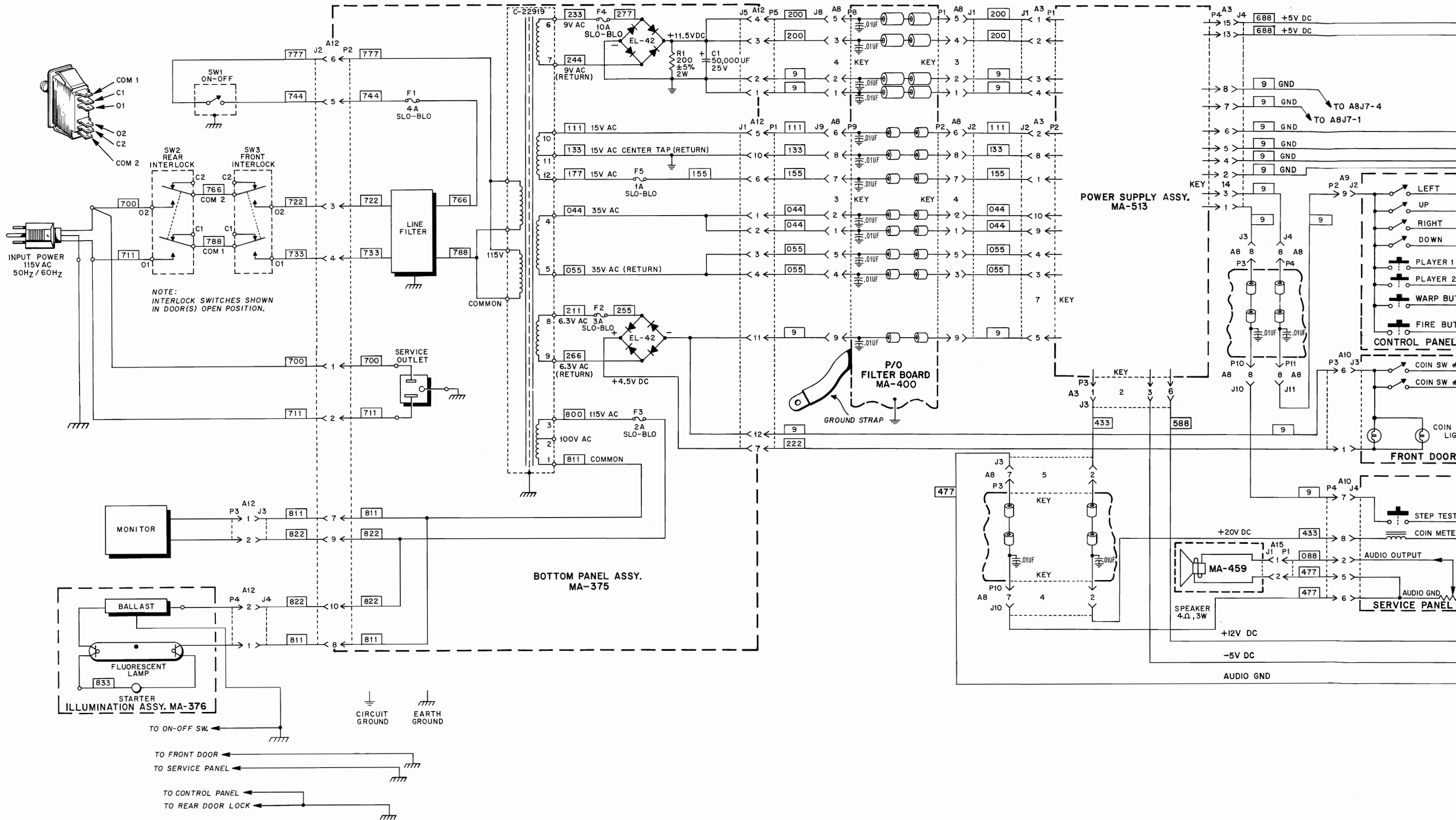

VIII. WIRING AND SCHEMATIC DIAGRAMS, PARTS LISTS

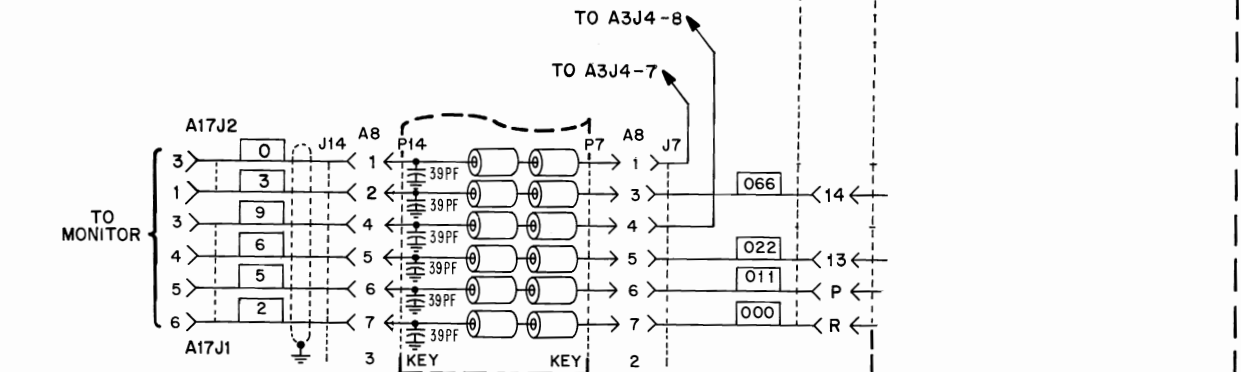
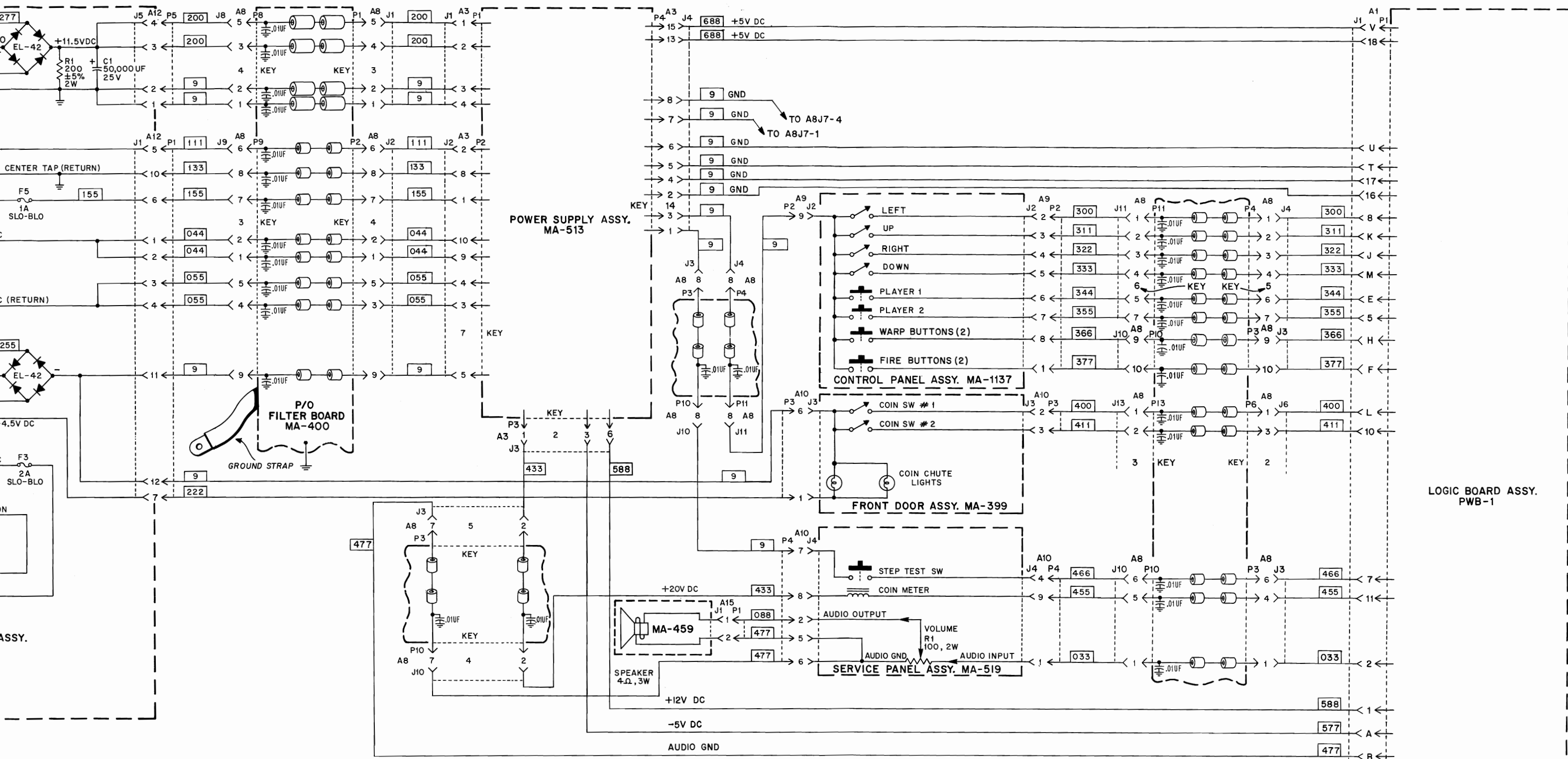

PRIMARY POWER/FILTER BOARD/INTERCONNECTION DIAGRAM

IX. PARTS INFORMATION

TABLE OF CONTENTS

	PAGE
SPEAKER/MARQUEE ASSY.	24
ILLUMINATION ASSY.	24
CONTROL PANEL ASSY.	25
SERVICE PANEL ASSY.	26
BOTTOM PANEL ASSY.	27
CABINET PARTS	28
CABINET PARTS	29

IX. PARTS INFORMATION

SPEAKER/MARQUEE ASSY. AND ILLUMINATION ASSY.

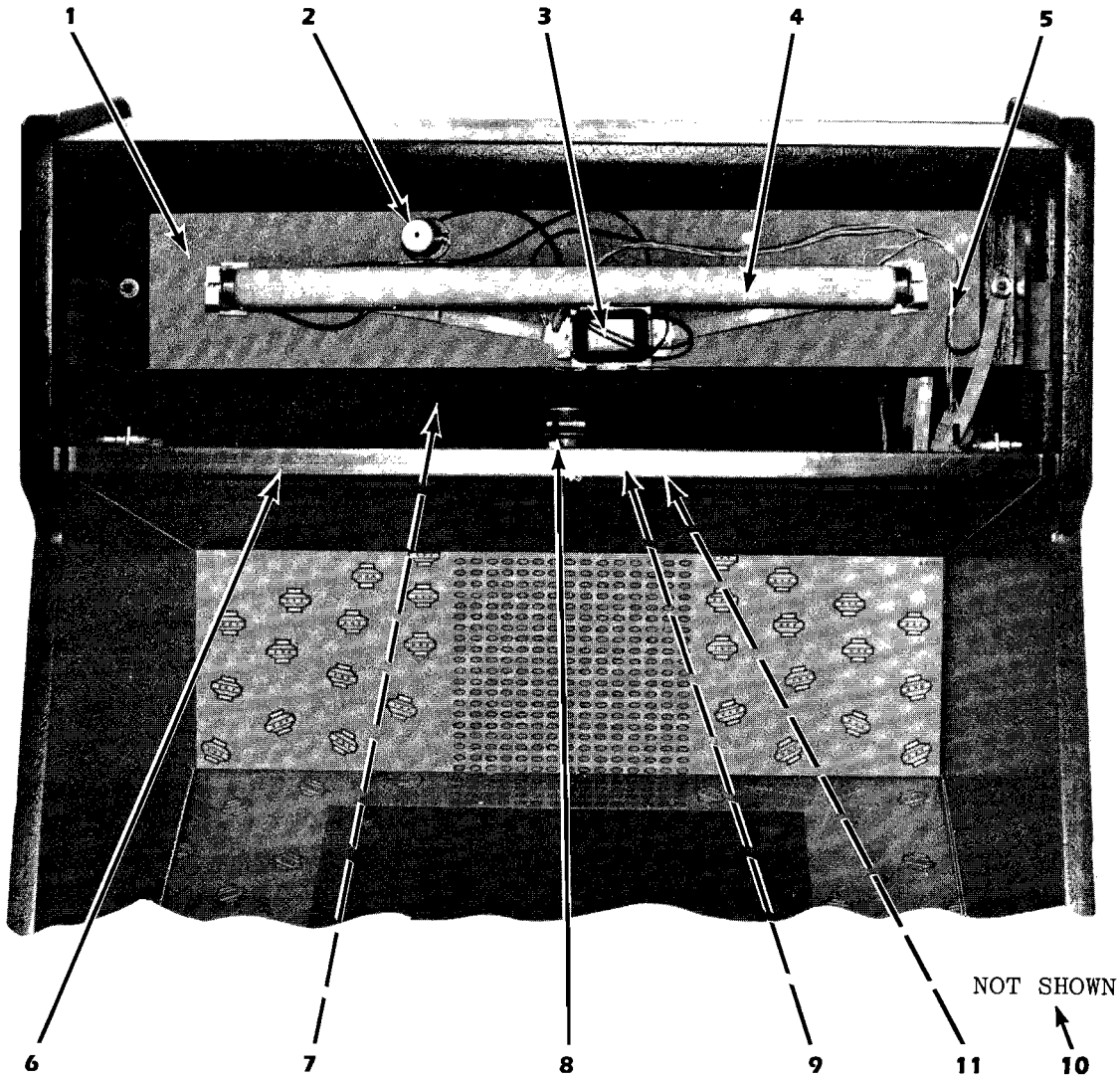

ITEM	DESCRIPTION	PART NO.
1.	Illumination Assy.	MA-376
2.	Starter	EL-69
3.	Ballast (60 HZ)	EL-70
4.	Lamp, Fluorescent	LA-4
5.	Cable Assy.	MA-364
6.	Speaker Assy.	MA-459
7.	Cable Assy.	MA-318
8.	Speaker	EL-93
9.	Speaker Grill	B-20931
10.	Marquee, Lexan (Screen)	A-23195
11.	Speaker Guard	B-20931

IX. PARTS INFORMATION

CONTROL PANEL ASSY.

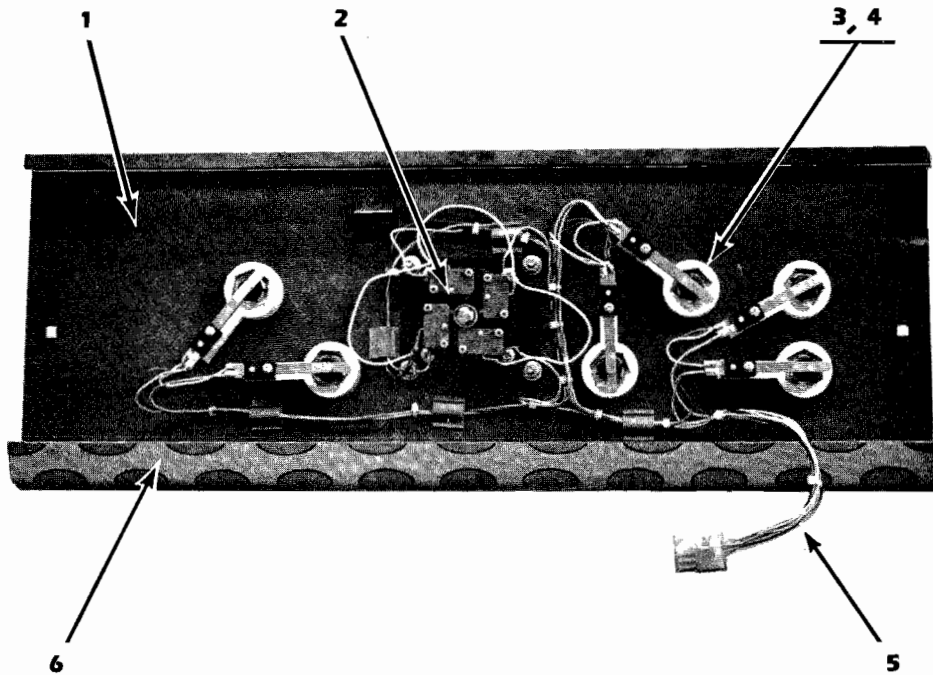

ITEM	DESCRIPTION	PART NO.
1.	Control Panel Assy.	MA-1137
2.	Joystick	C-23189
3.	Short Button (6)	A-21970
4.	Button Holder and Switch (6)	A-21971
5.	Cable Assy.	MA-514
6.	Lexan Overlay	A-23196

IX. PARTS INFORMATION

SERVICE PANEL ASSY.

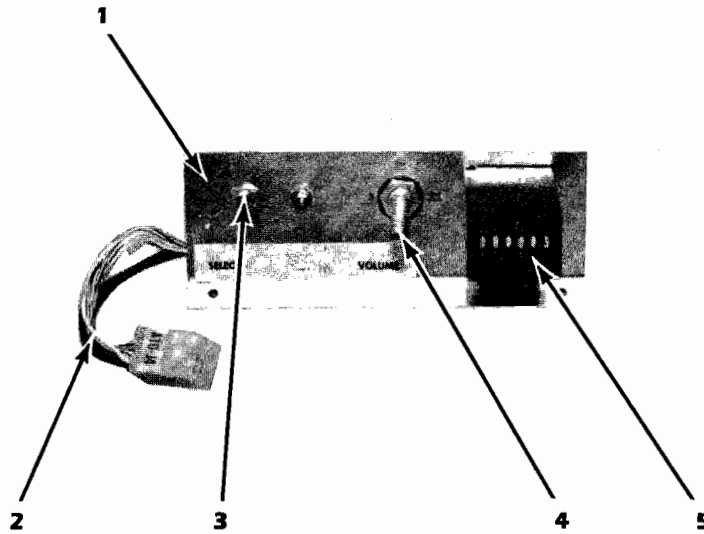

ITEM	DESCRIPTION	PART NO.
1.	Service Panel Assy.	MA-519
2.	Cable Assy.	MA-518
3.	Switch (Push Button)	EL-57
4.	Volume Control	XO-199
5.	Coin Meter	EL-84

IX. PARTS INFORMATION

BOTTOM PANEL ASSY.

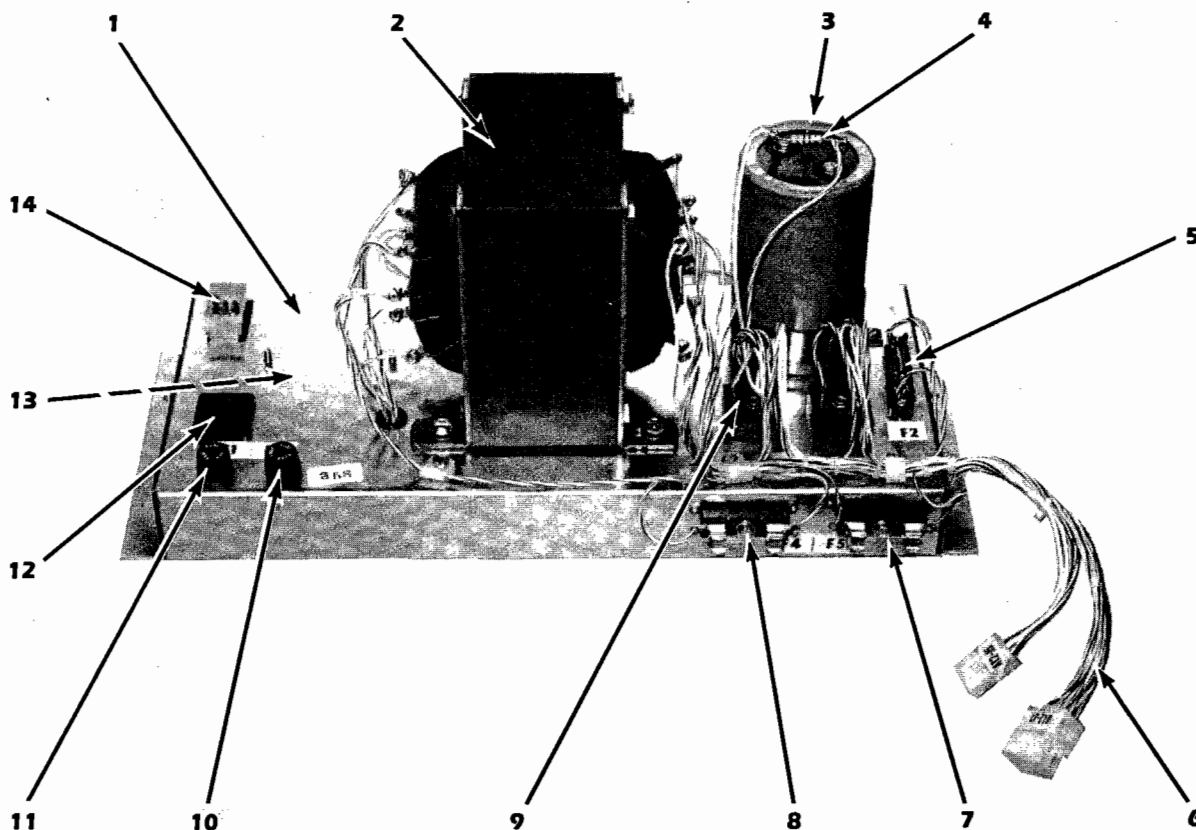

ITEM	DESCRIPTION	PART NO.
1.	Bottom Panel Assy.	MA-375
2.	Transformer	C-22919
3.	Capacitor, 50,000UF, 25V	XO-141
4.	Resistor, 200 OHM, 5%, 2W	XO-142
5.	Fuse Holder	EL-0
	Fuse, 3 Amp, SLO-BLO	EL-9
6.	Cable Assy. (Secondary)	MA-517
7.	Fuse Holder	EL-0
	Fuse, 1 Amp, SLO-BLO	EL-6
8.	Fuse Holder	EL-0
	Fuse, 10 Amp	EL-23
9.	Bridge Rectifier (2)	EL-42
10.	Fuse Holder	EL-78
	Fuse, 2 Amp, SLO-BLO	EL-7
11.	Fuse Holder	EL-78
	Fuse, 4 Amp, SLO-BLO	EL-33
12.	Service Outlet	A-18133
13.	Line Filter	EL-50
14.	Cable Assy. (Primary)	MA-363

IX. PARTS INFORMATION

CABINET PARTS

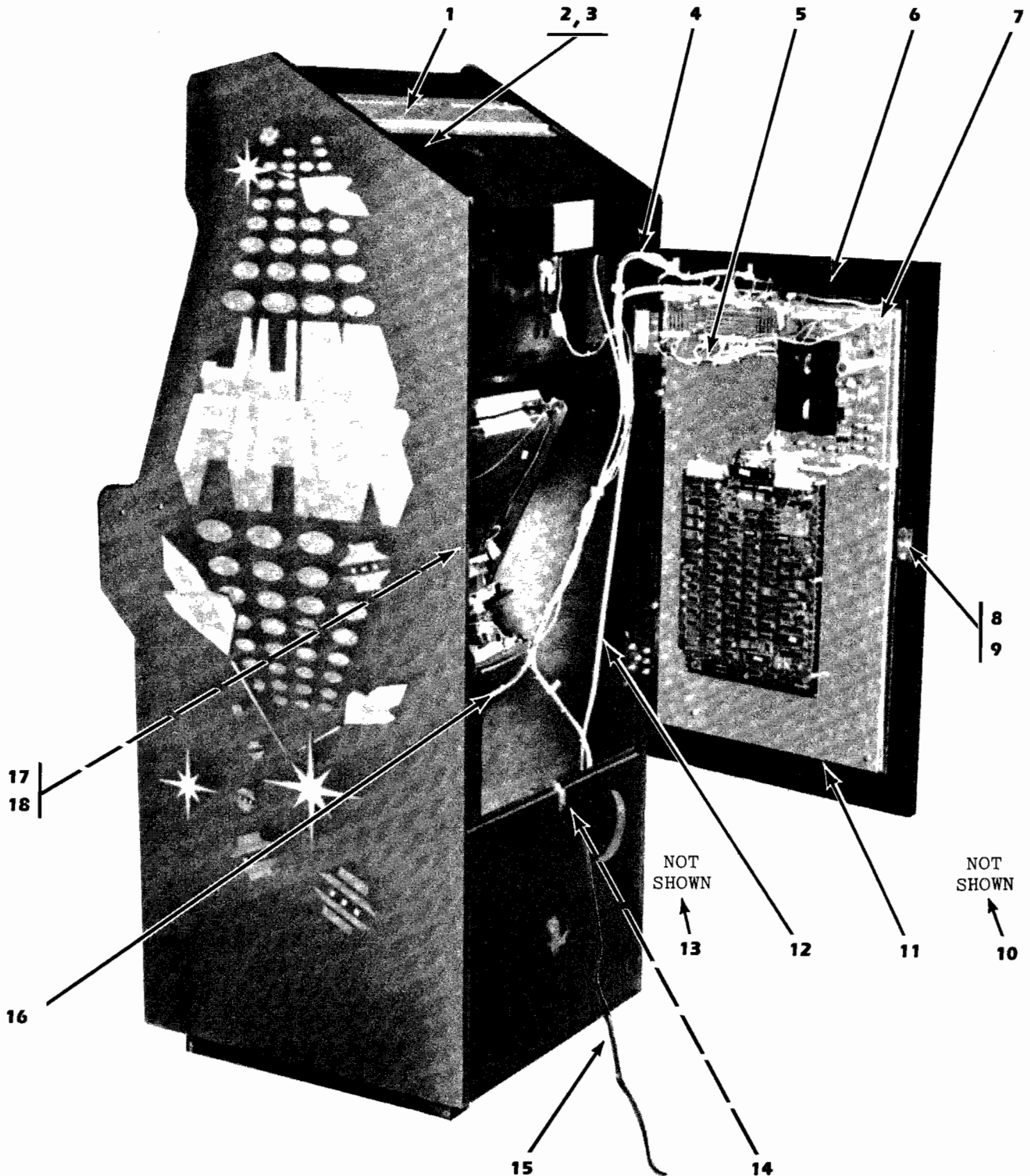

ITEM	DESCRIPTION	PART NO.
1.	Vent Channel (2)	D-21754
2.	On-Off Switch	EL-56
3.	Switch Plate	A-22396
4.	Cable Assy. Master Electronics	MA-515
5.	Interconnect Cable	MA-516
6.	Back Door	D-23073-3
7.	Master Electronic Board	MA-1157
8.	Rear Door Lock	MH-0
9.	Anchor Plate, Lock	MH-1

ITEM	DESCRIPTION	PART NO.
10.	Shield, Top	D-22632
11.	Shield, Bottom	C-22633
12.	Monitor Cable	A-23244-1
13.	Clip Bracket, Shield	B-22631
14.	Cover Plate, Line Cord	A-21955
15.	Line Cord	B-15357
16.	Cable Assy. High Voltage	MA-360
17.	Interlock Switch	EL-66
18.	Cover, Interlock Switch	A-21888

IX. PARTS INFORMATION

CABINET PARTS

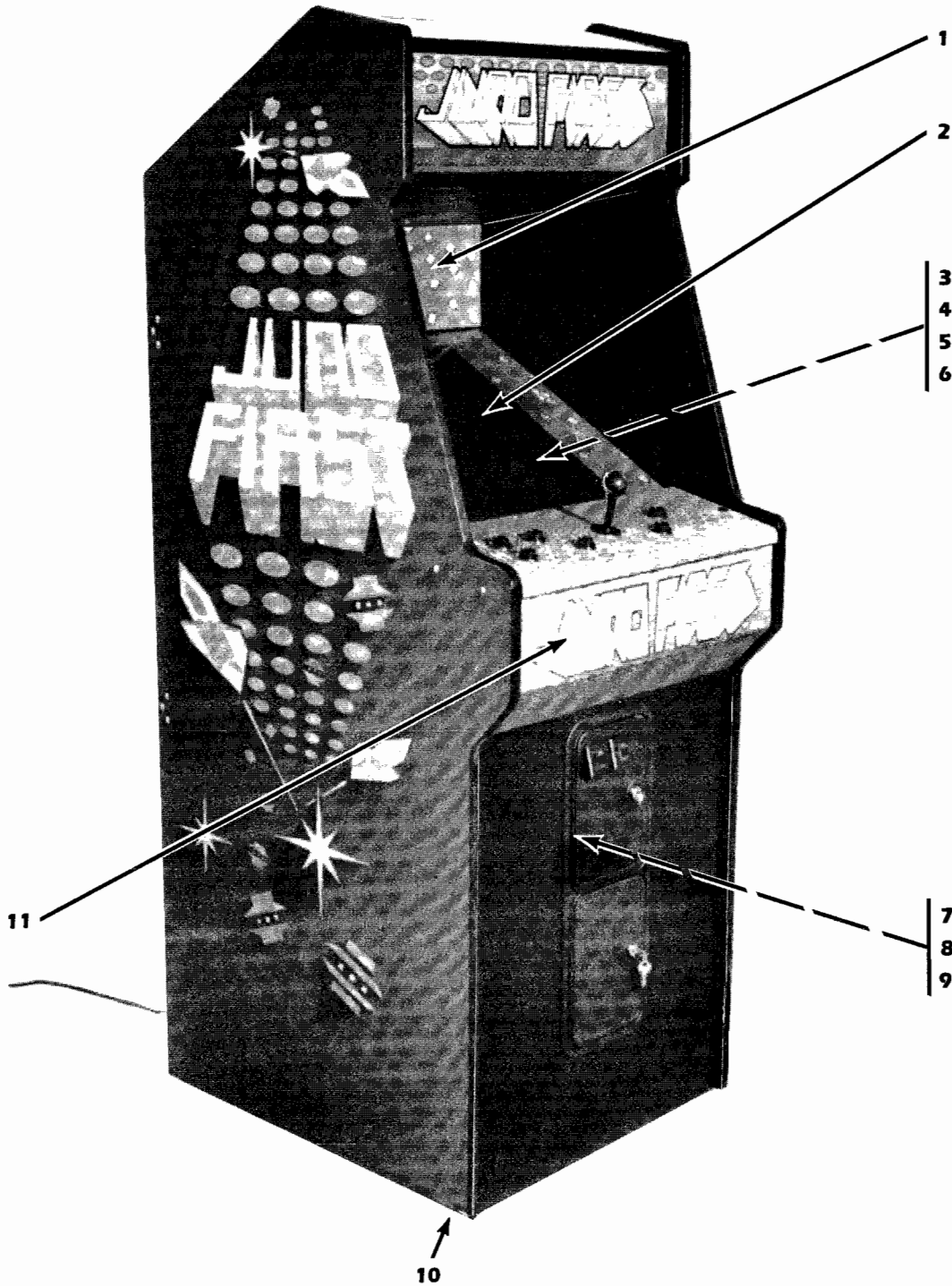

ITEM	DESCRIPTION	PART NO.	ITEM	DESCRIPTION	PART NO.
1.	Rear Side CRT Decal	A-23198	7.	Cable Assy. Front Door	MA-396
2.	Top Glass	A-22464	8.	Interlock Switch	EL-66
3.	CRT Frame	A-23199	9.	Cover, Interlock Switch	A-21888
4.	Monitor Filter Glass	C-22849-1	10.	3" Leg Adjuster (2)	MH-21
5.	Monitor Mask	D-22463	11.	Lexan Overlay (Screen)	A-23197
6.	Monitor	C-23260			



WELLS-GARDNER ELECTRONICS CORPORATION

19" IN LINE COLOR MONITORS

MODELS

19K4901
19K4906

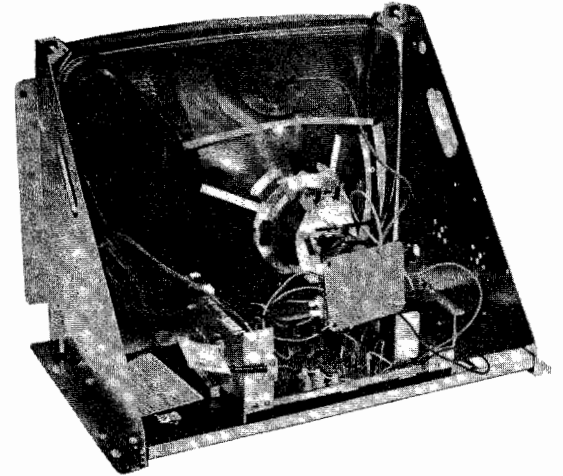
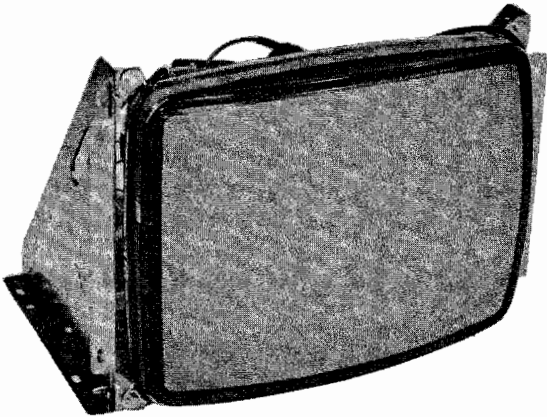

MODELS

19K4951
19K4956
19K4951RYC

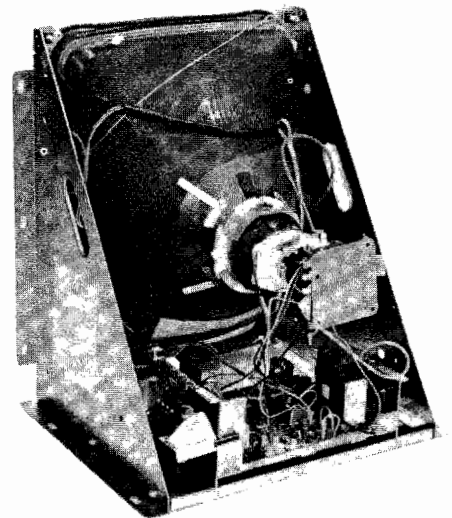
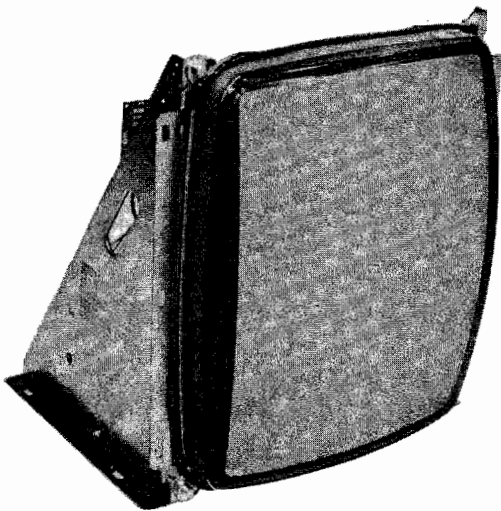

**WELLS-GARDNER ELECTRONICS
CORPORATION**

2701 NORTH KILDARE AVENUE
CHICAGO, ILLINOIS 60639

WARNINGS

1. Power Up Warning—

An isolation transformer must be used between the AC supply and the AC plug of the monitor before servicing or testing is performed since the chassis and the heat sink are directly connected to one side of the AC line which could present a shock hazard.

Before servicing is performed, read all the precautions labelled on the CRT and chassis.

2. **X-RAY RADIATION WARNING NOTICE**

WARNING: PARTS WHICH INFLUENCE X-RAY RADIATION IN HORIZONTAL DEFLECTION, HIGH VOLTAGE CIRCUITS AND PICTURE TUBE ETC. ARE INDICATED BY (★) IN THE PARTS LIST FOR REPLACEMENT PURPOSES. USE ONLY THE TYPE SHOWN IN THE PARTS LIST.

3. High Voltage—

This monitor contains HIGH VOLTAGES derived from power supplies capable of delivering LETHAL quantities of energy. Do not attempt to service until all precautions necessary for working on HIGH VOLTAGE equipment have been observed.

4. CRT Handling—

Care must be taken not to bump or scratch the picture tube as this may cause the picture tube to implode resulting in personal injury. Shatter proof goggles must be worn when handling the CRT. High voltage must be completely discharged before handling. Do not handle the CRT by the neck.

5. **PRODUCT SAFETY NOTICE**

WARNING: FOR CONTINUED SAFETY REPLACE SAFETY CRITICAL COMPONENTS ONLY WITH MANUFACTURER RECOMMENDED PARTS. THESE PARTS ARE IDENTIFIED BY SHADING AND BY (△) ON THE SCHEMATIC DIAGRAM.

AVERTISSEMENT: POUR MAINTENIR LE DEGRE DE SECURITE DE L'APPAREIL NE REMPLACER LES COMPOSANTS DONT LE FONCTIONNEMENT EST CRITIQUE POUR LA SECURITE QUE PAR DES PIECES RECOMMANDEES PAR LE FABRICANT.

For replacement purposes, use the same type or specified type of wire and cable, assuring the positioning of the wires is followed (especially for H.V. and power supply circuits). Use of alternative wiring or positioning could result in damage to the monitor or in a shock or fire hazard.

PERFORMANCE AND OPERATING DATA

1. Apply a suitable power source to the monitor through an isolation transformer.

2. Apply a suitable signal source to the monitor PCB by means of P201 and P202

3. Set Up Controls.

All controls are preset at the factory, but may be adjusted to suit program material.

1.0 Supply

Voltage 108 VAC-132 VAC

Frequency 50 Hz-60 Hz

Note: Apply supply voltage through an isolation transformer with 1 Amp. minimum capability.

2.0 High Voltage (EHT)

For 19"V models 24.3 ± 0.8 K.V. at 0 Beam; 22.8 ± 0.8 K.V. at 1 mA Beam

Note: Condition for above: A.C. = 120V

3.0 Service Set-Up Controls

MAIN PC BOARD

3.1 Vertical Hold Control, VR301

3.2 Vertical Size Control, VR303

3.3 Horizontal Hold Control, VR351

3.4 Vertical Raster Position Adjustment Jumper (3 positions)

3.5 Horizontal Raster Position Adjustment Jumper (3 positions)

3.6 Screen Control (Part of H.V. Unit, T352)

3.7 Focus Control (Part of H.V. Unit, T352)

3.8 Horizontal Width Coil, L352

3.9 Black Level Control, VR201

3.10 Horizontal Video Position Control, (Horizontal Shift) VR352

NECK PC BOARD

3.11 Video Drive Controls, Red VR401
Green VR402

3.12 CRT Cut Off Controls, Red VR403
Green VR404
Blue VR405

SERVICE INSTRUCTIONS

NOTE: All monitors are equipped with automatic degaussing coils (L701) which demagnetize the picture tube every time the monitor is turned on after being off for a minimum of 5 minutes. Should any part of the chassis become magnetized it will be necessary to degauss the affected area with a manual degaussing coil. Move the coil slowly around the CRT face area and all surrounding metal parts. Then slowly withdraw for a distance of 6 feet before turning off.

1.0 BLACK LEVEL CONTROL ADJUSTMENT

This control has been set at the factory and should not need further attention, however, when the game is connected a slight adjustment of VR201 may be necessary to obtain the proper black level (the black portion of the picture just extinguished).

2.0 VERTICAL SIZE (HEIGHT)

Location of this control is shown in Fig. 1. This control must be adjusted slowly, if necessary, until the picture or test pattern attains the correct vertical proportions.

3.0 CIRCUIT PROTECTION

A 4.0A pigtail fuse, mounted on the Main Board has been provided to protect the Power Output Circuit.

4.0 FOCUS

Adjust the Focus control, located on the HV unit (T352), for maximum over-all definition and fine picture detail.

5.0 HORIZONTAL HOLD CONTROL ADJUSTMENT, VR351 (See Fig. 1)

A warm-up period of at least five minutes should be allowed before alignment is carried out. With the monitor being driven from the game signal, short TP601 to TP31. Adjust VR351 until the picture stops sliding horizontally. Remove the short.

6.0 HORIZONTAL VIDEO POSITION

If the video is off center on the raster some compensation can be made by adjusting this control.

7.0 VERTICAL RASTER POSITION ADJUSTMENT

If the video is off center vertically, (short dimension of picture tube) some compensation can be made by moving the vertical raster position adjustment jumper to either positions "U" or "D".

8.0 HORIZONTAL RASTER POSITION ADJUSTMENT

If the video is off center horizontally (long dimension of the picture tube) some compensation can be made by moving the horizontal raster position adjustment jumper to either positions "R" or "L".

9.0 HORIZONTAL WIDTH ADJUSTMENT

The horizontal width coil is a hexagonal tuning tool adjustment. This control must be adjusted slowly, if necessary, until the picture or test pattern attains the correct horizontal proportions.

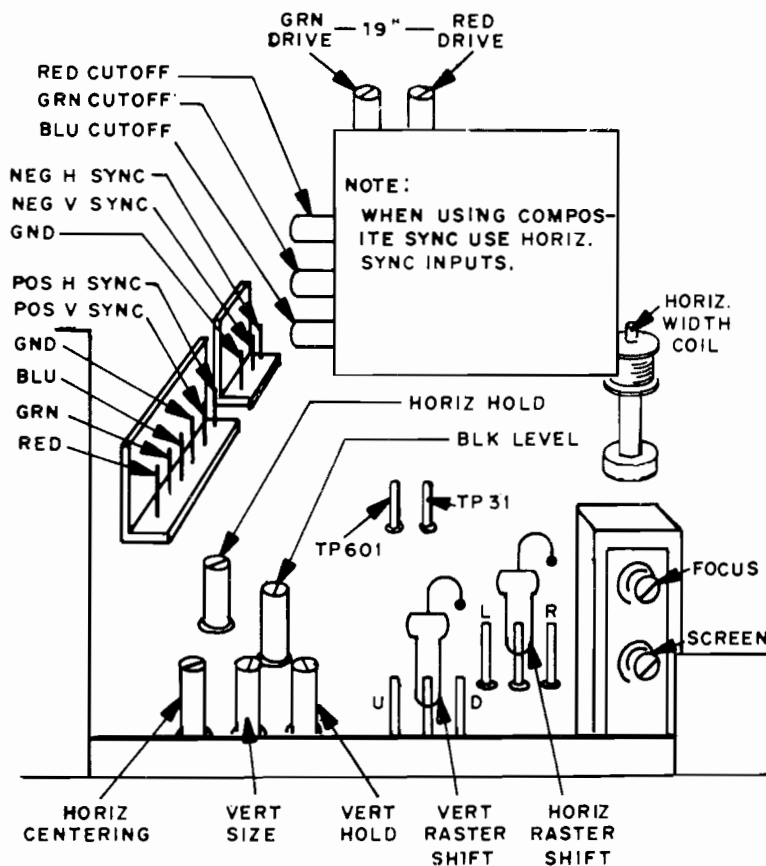

FIGURE 1

INSTALLATION AND SERVICE INSTRUCTIONS

NOTE: All of the following procedures have been performed at the factory and should require no further attention. If the monitor is serviced for any reason, it should be observed afterward to determine whether any of these procedures need to be performed again.

OUTLINE OF CONVERGENCE AND SET-UP PROCEDURE

- 1.0 Degaussing-Demagnetize the shadow mask and all surrounding metal parts with an external degaussing coil.
- 2.0 Purity and Vertical Centering—Adjust the purity magnet and the yoke position.
- 3.0 Static Convergence-Converge Red and Blue on Green in the center of the screen.
- 4.0 Dynamic Convergence-Converge Red and Blue at the edges of the screen.
- 5.0 White Balance-Set Gray and White brightness tracking.

NOTE: Number 2.0 and 3.0 adjustments interact.

1.0 DEGAUSSING

The monitor is equipped with an automatic degaussing circuit. However, if the CRT shadow mask has become excessively magnetized, it may be necessary to degauss it with a manual coil. Do not switch the coil OFF while the raster shows any effect from the coil.

2.0 COLOR PURITY AND VERTICAL CENTERING ADJUSTMENT

- 2.1 For best results, it is recommended that the purity adjustment be made in the final monitor location. If the monitor will be moved, perform this adjustment with it facing west or east. The monitor must have been operating 15 minutes prior to this procedure.
- 2.2 Set the converger assembly on the CRT neck with the center line (of the Purity Adjustment Magnet) over the gap between grids no. 3 & 4. (See Figures 2 & 6)
- 2.3 Make certain that the magnetic ring-pairs are in their correct positions before starting procedure. This produces a zero-correction state and helps facilitate adjustments.
- 2.4 Vertical raster position adjustment jumper must be in position "C" (center).
- 2.5 Remove the R-G-B signal from the monitor.
- 2.6 Turn the Green Cut off Control (VR404) on the Neck Board fully CW. (See Fig. 3)
- 2.7 Turn the Red and Blue Cut off Controls (VR403 & VR405) fully CCW.
- 2.8 Pull the Deflection Yoke backward so that the Green belt will appear. (See Fig. 4)
- 2.9 Decrease the horizontal width of the raster, if necessary, in order to be able to see the right and left edges of the raster.
- 2.10 Move the two Purity Magnets with respect to each other in order to center the raster on the screen and the Green belt on the raster horizontally.
- 2.11 Push the Deflection Yoke forward gradually and fix it at the place where the Green screen becomes uniform throughout.
- 2.12 Turn the Cut off and Drive Controls and confirm that each color is uniform.
- 2.13 If the color is not uniform, re-adjust it moving the Purity Magnets slightly.
- 2.14 Decrease the vertical size of the raster, if necessary, such that the top and bottom raster edges can be seen.

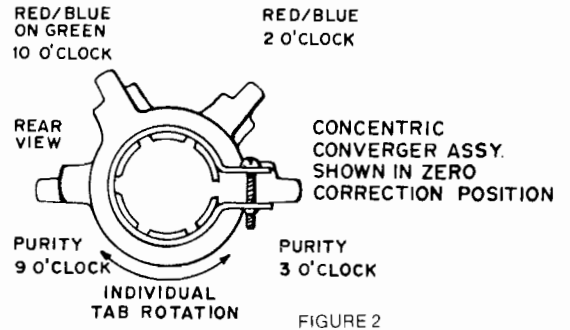
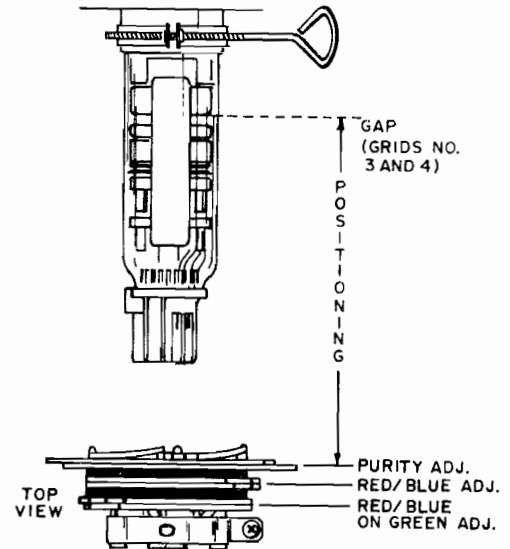

FIGURE 2

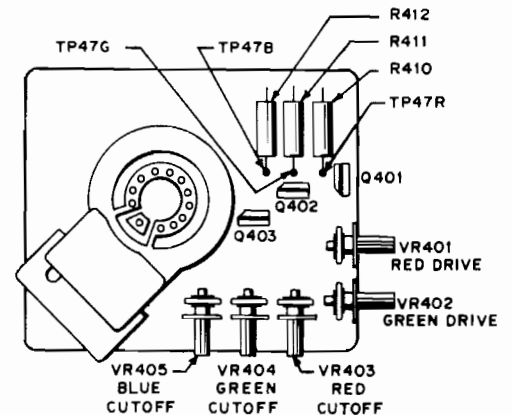

FIGURE 3

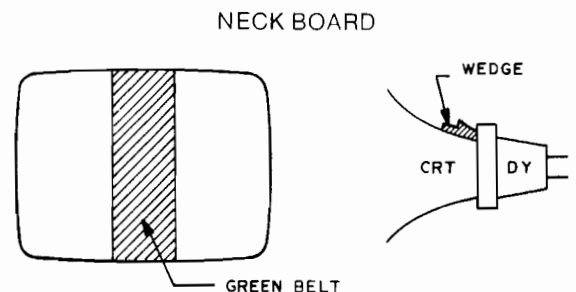

FIGURE 4

- 2.15 Rotate the Purity Magnets as a pair (without changing the angle of one magnet relative to the other) in order to center the raster on the screen vertically.
- 2.16 Readjust the raster to the desired vertical size.
- 2.17 Turn all three cut off controls fully counterclockwise (CCW). Slowly turn up (CW) the Red cutoff control until a Red raster is just barely visible.
- 2.18 Slowly turn up the Green and Blue cutoff controls such that their associated colors, mixing with the Red, results in a White or Gray raster.
- 2.19 Confirm that the white or gray color is uniform throughout the screen.
- 2.20 Insert a wedge temporarily as shown in Fig. 4 and adjust the angle of the Deflection Yoke.

3.0 STATIC CONVERGENCE ADJUSTMENT

4-Pole Magnets and 6-Pole Magnets are for static convergence.

- 3.1 A cross hatch signal should be connected to the monitor.
- 3.2 A pair of 4-Pole Convergence Magnets is provided and adjusted to converge the blue and red beams. (See Fig. 6) When the Pole opens to the left and right 45° symmetrically, the magnetic field maximizes. Red and blue beams move to the left and right. (See Fig. 5) Variation of the angle between the tabs adjusts the convergence of red and blue vertical lines.
- 3.3 When both 4-Pole Convergence Magnet Tabs are rotated as a pair, the convergence of the red and blue horizontal lines is adjusted.
- 3.4 A pair of 6-Pole Convergence Magnets is also provided and adjusted to converge the magenta (red + blue) to green beams. (See Fig. 6). When the Pole opens to the left and right 30° symmetrically, the magnetic field is maximized. Red and blue beams both move to the left and right (See Fig. 5). Variation of the opening angle adjusts the convergence of magenta to green vertical lines.
- 3.5 When both 6-Pole Convergence Magnet Tabs are rotated as a pair, the convergence of magenta to green horizontal lines is adjusted.

GREEN GUN IS THE CENTER GUN.
CONVERGE THE RED AND BLUE.
THEN CONVERGE RED AND BLUE ON GREEN.

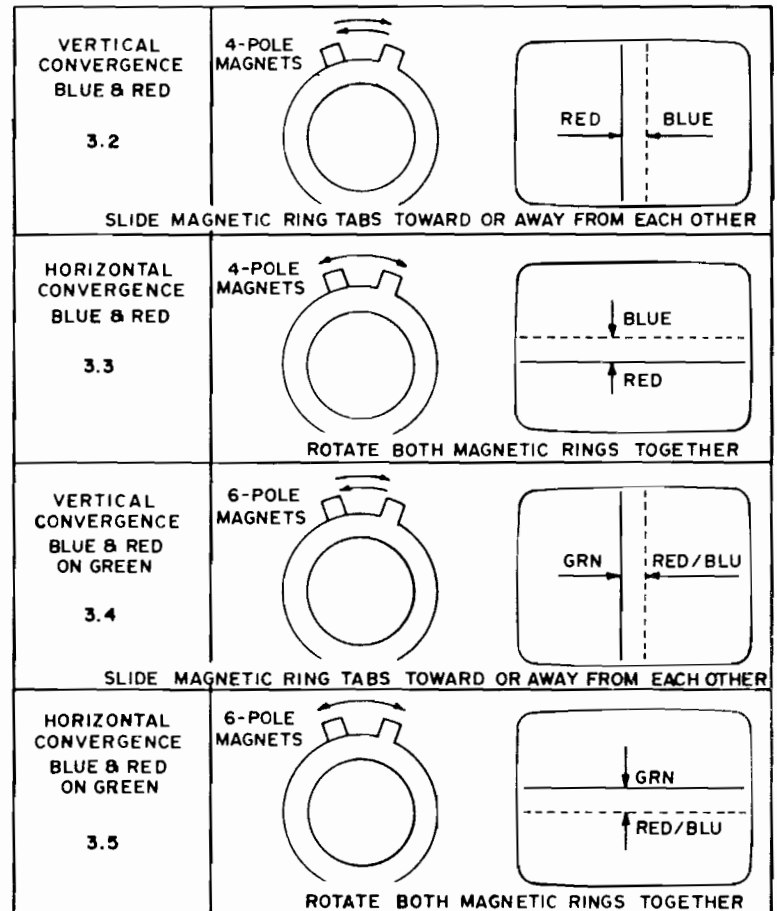

REPEAT 3.2 & 3.3 IF ALL LINES ARE NOT CONVERGED AT CENTER

5827

FIGURE 5

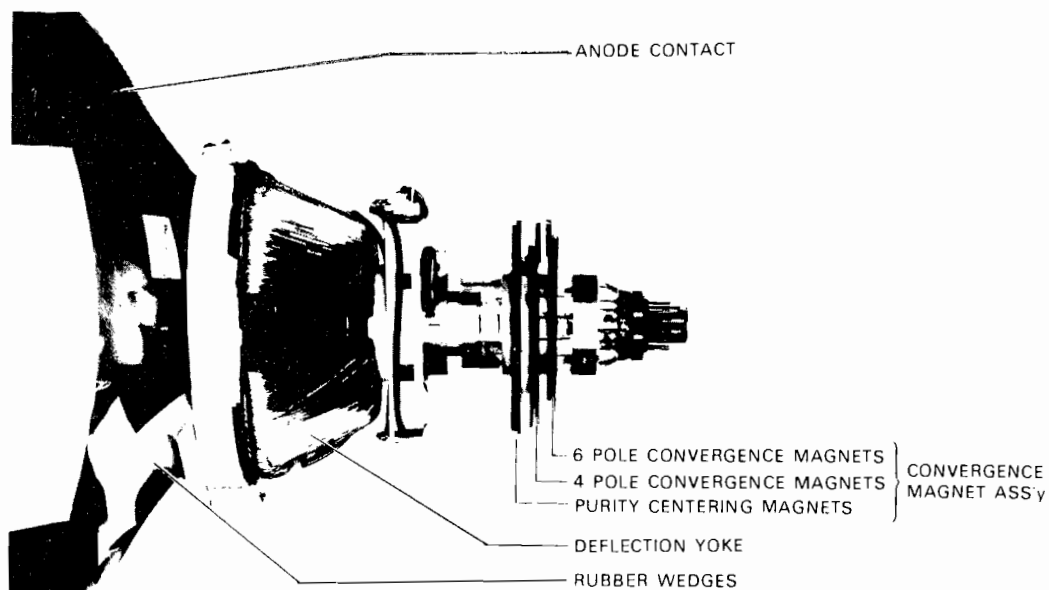

FIGURE 6

4.0 PRECISE ADJUSTMENT OF DYNAMIC CONVERGENCE (See Fig. 7, 8 and 9)

- 4.1 Feed a cross hatch signal to the monitor.
- 4.2 Insert a wedge temporarily and fix the Deflection Yoke so as to obtain the best circumference convergence (See Fig. 8 and 9)

NOTE:

The wedges may need to be moved during adjustments.

- 4.3 Insert three rubber wedges to the position as shown in Fig. 7 to obtain the best circumference convergence.

NOTE:

- 1) Tilting the angle of the yoke up and down adjusts the crossover of both vertical and horizontal red and blue lines. See Fig. 8 (a) and (b).
- 2) Tilting the angle of the yoke sideways adjusts the parallel convergence of both horizontal and vertical lines at the edges of the screen. See Fig. 9 (a) and (b).
- 3) Use three rubber wedges (tapered rubber wedges are used for a purpose).
- 4) The position of each rubber wedge is shown in Fig. 7.
- 5) Do NOT force the permanent wedges in. They are to be inserted until they just make contact with the yoke—after the yoke has been positioned.
- 6) Fix the three permanent rubber wedges with chloroprene rubber adhesive.
- 7) After the adhesive has dried enough to hold the wedges in place, carefully remove the temporarily installed wedge.

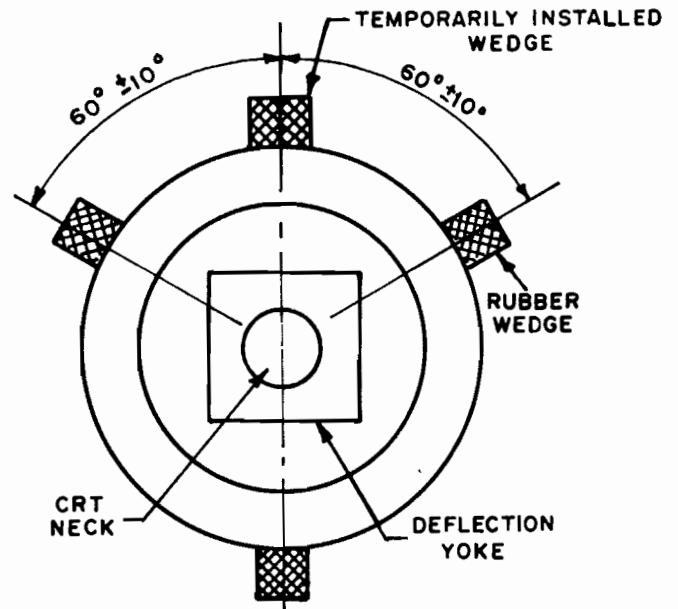

FIGURE 7

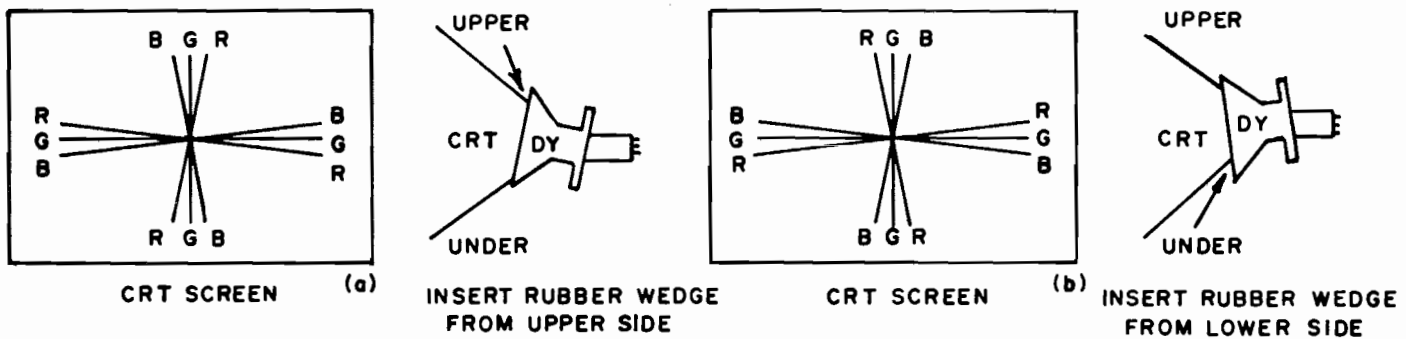

FIGURE 8

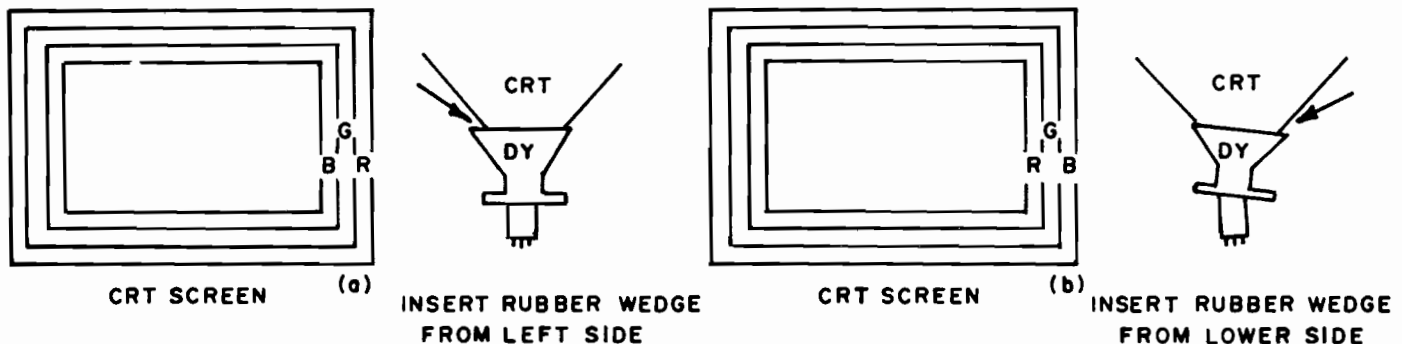

FIGURE 9

5.0 WHITE BALANCE

- 5.1 Refer to Fig. 2 and do the following in subdued light.
- 5.2 Ground the R/G/B inputs.
- 5.3 Set the R/G drive controls to their mechanical centers.
- 5.4 Set the screen and R/G/B cutoff controls to minimum (fully CCW).
- 5.5 Connect a jumper wire between TP301 and TP302 (located on the MAIN PCB)
- 5.6 Slowly turn up (CW) the screen control until the first colored line becomes just barely visible. That color which has just appeared is referred to as the "lead" color. Do NOT turn its associated cutoff control—it must remain fully CCW.
- 5.7 Connect a DC oscilloscope to the collector of the lead color's output transistor (Q401, Q402, or Q403) on the Neck PCB at TP47R, TP47G, or TP47B.
- 5.8 Adjust the black level control (VR201) to obtain the waveform shown in Fig. 10.
- 5.9 Readjust the screen control such that the colored line is just barely visible.
- 5.10 Slowly turn up the two remaining cutoff controls such that their associated colors, mixing with the lead color, results in a white or gray line.
- 5.11 Remove the jumper wire.
- 5.12 Adjust the Black Level Control for a dim raster. Touch up the two trailing cutoff controls (NOT the lead cutoff control) for best gray uniformity.
- 5.13 Adjust the Black Level Control for a bright raster. Adjust the R/G drive controls, if necessary for best neutral white.
- 5.14 Repeat steps 5.12 and 5.13 until good tracking of white balance is achieved.

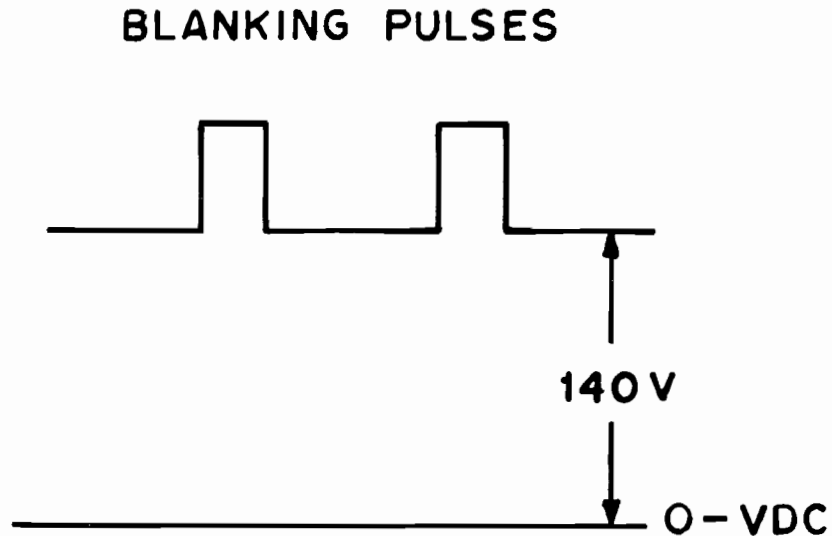

FIGURE 10

REPLACEMENT PARTS LIST

This monitor contains circuits and components included specifically for safety purposes.

For continued protection no changes should be made to the original design, and components shown in shaded areas of schematic, or **Δ★** on parts list should be replaced with exact factory replacement parts.

The use of substitute parts may create a shock, fire, radiation or other hazard. Service should be performed by qualified personnel only.

MAIN BOARD

Ref. No.	Part No.	Description	Ref. No.	Part No.	Description
RESISTORS			RESISTORS (CONT.)		
R201	203X6500-645	1K Ohm, 5%, 1/4W Carbon	R369	203X5602-329	680K Ohm, 5%, 1/2W Comp.
R202	203X6500-523	30 Ohm, 5%, 1/4W Carbon	R370	203X6501-002	33K Ohm, 5%, 1/4W Carbon
R203	203X6500-405	100 Ohm, 5%, 1/4W Carbon	R371	203X9014-584	1K Ohm, 5%, 1W Metal Oxide
R204	203X6700-327	100 Ohm, 5%, 1/2W Carbon	R372	203X9101-119	12K Ohm, 5%, 1W Metal Oxide
R205	203X6700-421	270 Ohm, 5%, 1/2W Carbon	R375	203X6700-763	6.8K Ohm, 5%, 1/2W Carbon
R206	203X6500-540	390 Ohm, 5%, 1/4W Carbon	R376	203X9104-404	270 Ohm, 5%, 2W Metal Oxide
R207	340X2201-934	200 Ohm, 5%, 1/4W Carbon	R377	203X6500-447	150 Ohm, 5%, 1/4W Carbon
R208	203X6500-540	390 Ohm, 5%, 1/4W Carbon	R378	203X6500-886	10K Ohm, 5%, 1/4W Carbon
R209	340X2201-934	200 Ohm, 5%, 1/4W Carbon	R379	203X6500-886	10K Ohm, 5%, 1/4W Carbon
R210	203X6500-540	390 Ohm, 5%, 1/4W Carbon	R380	203X6500-865	8.2K Ohm, 5%, 1/4W Carbon
R211	340X2201-934	200 Ohm, 5%, 1/4W Carbon	R381	203X6500-724	2.2K Ohm, 5%, 1W Metal Oxide
R214	203X6500-645	1K Ohm, 5%, 1/4W Carbon	R383	203X9014-387	150 Ohm, 5%, 1W Metal Oxide
R215	203X6501-126	100K Ohm, 5%, 1/4W Carbon	R502	203X6500-886	10K Ohm, 5%, 1/4W Carbon
R216	203X6500-645	1K Ohm, 5%, 1/4W Carbon	R503	204X1700-535	150 Ohm, 5%, 15W Metal Oxide
R217	203X6500-405	100 Ohm, 5%, 1/4W Carbon	R504	203X9014-267	47 Ohm, 5%, 1W Metal Oxide
R218	203X6500-645	1K Ohm, 5%, 1/4W Carbon	R505	203X6501-209	2.2K Ohm, 5%, 1/4W Carbon
R219	203X6501-126	100K Ohm, 5%, 1/4W Carbon	R506	203X9104-105	15 Ohm, 5%, 2W Metal Oxide
R220	203X6500-645	1K Ohm, 5%, 1/4W Carbon	R507	203X5602-185	330K Ohm, 5%, 1/2W Comp.
R221	203X6500-405	100 Ohm, 5%, 1/4W Carbon	Δ★R601	204X1625-058	3.3 Ohm, 5%, 10W WW
R222	203X6500-762	3.3 Ohm, 5%, 1/4W Carbon	R701	203X9105-141	2.2 Ohm, 5%, 2W Metal Oxide
R224	203X6500-169	10 Ohm, 5%, 1/4W Carbon	R702	203X6206-441	2.2 Ohm, 5%, 1/2W Carbon
R225	203X6500-169	10 Ohm, 5%, 1/4W Carbon	VR201	204X2070-072	2K Ohm-B Semi-Fixed
R226	203X6500-169	10 Ohm, 5%, 1/4W Carbon	VR301	204X2070-084	5K Ohm-B Semi-Fixed
R227	203X6501-044	47K Ohm, 5%, 1/4W Carbon	VR303	204X2070-055	500 Ohm-B Semi-Fixed
R228	203X6500-645	1K Ohm, 5%, 1/4W Carbon	VR351	204X2070-072	2K Ohm-B Semi-Fixed
R229	203X6700-421	270 Ohm, 5%, 1/2W Carbon	VR352	204X2070-072	2K Ohm-B Semi-Fixed
R230	203X6500-863	8.2K Ohm, 5%, 1/2W Comp.			
R231	203X6500-863	8.2K Ohm, 5%, 1/2W Comp.			
R232	203X6500-863	8.2K Ohm, 5%, 1/2W Comp.			
R233	203X6500-468	180 Ohm, 5%, 1/4W Carbon			
R234	340X2820-934	82 Ohm, 5%, 1/4W Carbon			
R235	340X2820-934	82 Ohm, 5%, 1/4W Carbon			
R236	340X2820-934	82 Ohm, 5%, 1/4W Carbon			
R301	203X6500-508	270 Ohm, 5%, 1/4W Carbon	C201	203X0014-088	1000 uF, 16V, Electrolytic
R302	203X6500-863	8.2K Ohm, 5%, 1/4W Carbon	C202	202X7200-064	330 pF, 500V, Ceramic
R303	203X6500-863	8.2K Ohm, 5%, 1/4W Carbon	C203	202X7200-043	220 pF, 500V, Ceramic
R304	203X6500-724	2.2K Ohm, 5%, 1/4W Carbon	C204	202X7200-043	220 pF, 500V, Ceramic
R305	203X6500-842	6.8K Ohm, 5%, 1/4W Carbon	C205	203X0014-076	470 uF, 16V, Electrolytic
R306	203X6003-201	7.5K Ohm, 2%, 1/4W Carbon	C206	203X1810-149	0.1 uF, 125V Mylar
R307	203X6500-825	5.6K Ohm, 5%, 1/4W Carbon	C207	349X2232-109	.022 uF, 100V Mylar
R309	203X6500-965	22K Ohm, 5%, 1/4W Carbon	C301	203X0014-065	330 uF, 50V Electrolytic
R310	203X6500-988	39K Ohm, 5%, 1/4W Carbon	C302	203X1600-563	0.033 uF, 50V Mylar
R311	203X6500-762	3.3K Ohm, 5%, 1/4W Carbon	C303	203X0629-037	3.3 uF, 50V Electrolytic
R312	203X9014-741	4.7K Ohm, 5%, 1/4W Carbon	C304	203X1600-366	0.068 pF, 50V Mylar
R313	204X1450-537	1K Ohm, 5%, 5W Carbon	C306	203X0412-012	2.2 uF, 16V Tantal
R314	203X6500-481	220 Ohm, 5%, 1/4W Carbon	C307	203X1600-634	0.033 uF, 50V Mylar
R315	203X6500-169	10 Ohm, 5%, 1/4W Carbon	C308	203X0025-174	3.3 uF, 50V Electrolytic
R316	203X6500-762	3.3K Ohm, 5%, 1/4W Carbon	C309	203X1207-100	0.068 uF, 100V PP
R317	203X6700-107	12 Ohm, 5%, 1/2W Carbon	C310	203X0629-061	10 uF, 100V Electrolytic
R318	203X6500-540	390 Ohm, 5%, 1/4W Carbon	C311	203X0041-025	10 uF, 160V Electrolytic
R319	203X6500-645	1K Ohm, 5%, 1/4W Carbon	C312	202X7050-248	1000 pF, 500V Ceramic
R320	203X6501-002	33K Ohm, 5%, 1/4W Carbon	C313	203X0040-052	47 uF, 160V Electrolytic
R321	203X6501-224	270K Ohm, 5%, 1/2W Carbon	C314	203X1201-265	0.033 uF, 200V PP
R322	203X6500-886	10K Ohm, 5%, 1/4W Carbon	C315	203X0629-023	1 uF, 50V Electrolytic
R351	203X6500-886	10K Ohm, 5%, 1/4W Carbon	C351	203X0629-023	1 uF, 50V Electrolytic
R352	203X6500-785	3.9K Ohm, 5%, 1/4W Carbon	C352	203X0619-045	47 uF, 25V Electrolytic
R353	203X6501-088	68K Ohm, 5%, 1/4W Carbon	C353	203X1190-015	0.0082 pF, 50V Mylar-PP
R354	203X6500-762	3.3K Ohm, 5%, 1/4W Carbon	C354	203X0619-045	47 uF, 25V Electrolytic
R355	203X9205-143	6.8K Ohm, 5%, 3W Metal Oxide	C355	203X1600-366	0.0068 pF, 50V Mylar
R358	203X5601-878	56K Ohm, 5%, 1/2W Carbon	C356	202X7050-483	0.01 uF, 500V Ceramic
R360	203X6500-561	470 Ohm, 5%, 1/4W Carbon	C359	202X8065-606	100 pF, 500V Ceramic
R361	203X6500-886	10K Ohm, 5%, 1/4W Carbon	C360	202X7050-366	0.0033 pF, 500V Ceramic
R362	203X9014-645	1.8K Ohm, 5%, 1W Metal Oxide	C361	202X7050-483	0.01 uF, 500V Ceramic
★R363	204X1527-751	3.9K Ohm, 5%, 7W Metal Oxide	C362	202X7203-032	0.01 uF, 50V Ceramic
R364	203X6500-246	22 Ohm, 5%, 1/4W Carbon	Δ★C363	203X1270-911	8700 pF, 1.5 KV PP
R365	203X6501-002	33K Ohm, 5%, 1/4W Carbon	★C365	203X1201-265	0.33 uF, 200V PP
R367	203X6500-886	10K Ohm, 5%, 1/4W Carbon	C366	203X0019-026	22 uF, 25V Electrolytic
R368	203X5602-185	330K Ohm, 5%, 1/2W Comp.	C367	202X8065-162	6 pF, 500V Ceramic
			C368	202X7203-032	0.01 uF, 50V Ceramic
			C372	203X1207-125	0.1 uF, 100V PP

P.C. BOARD LAYOUT

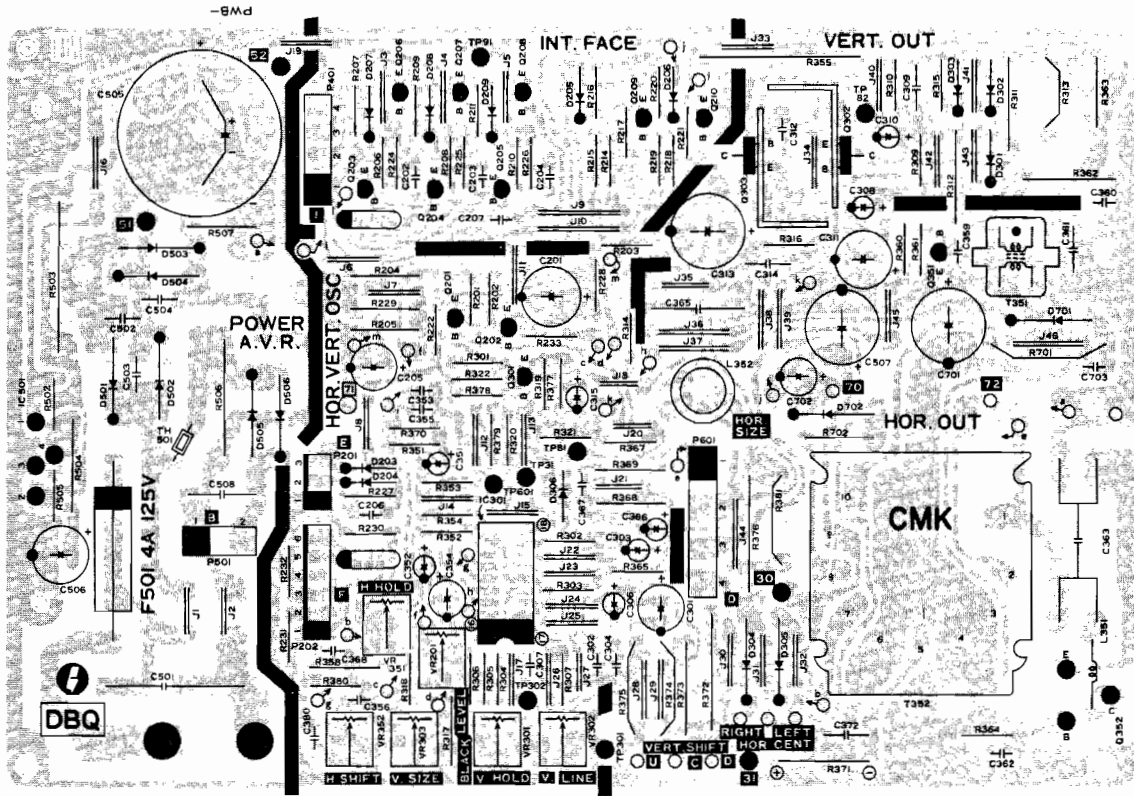

TOP VIEW

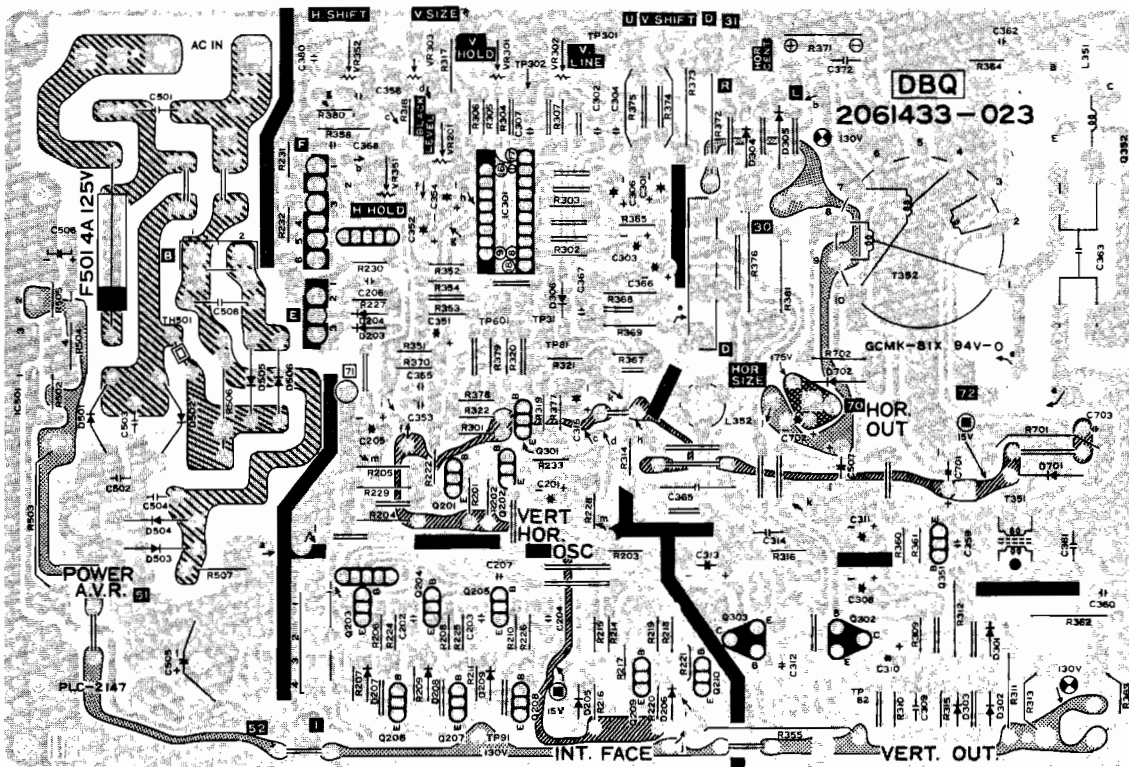

BOTTOM VIEW

FIGURE 11 MAIN P.C. BOARD

P.C. BOARD LAYOUT

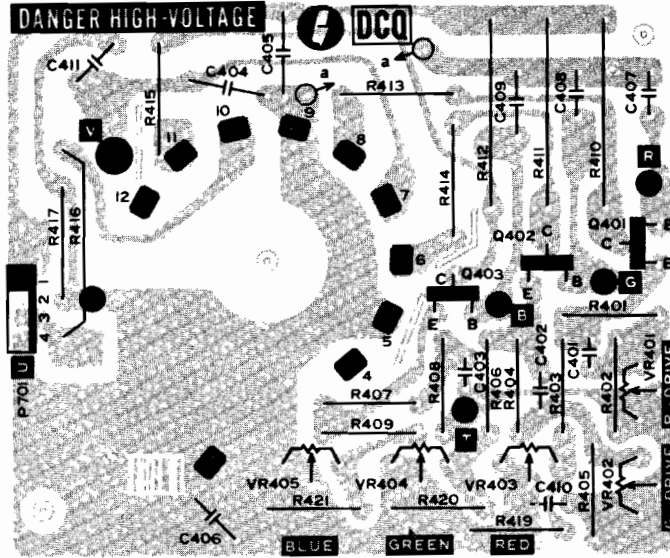

TOP VIEW

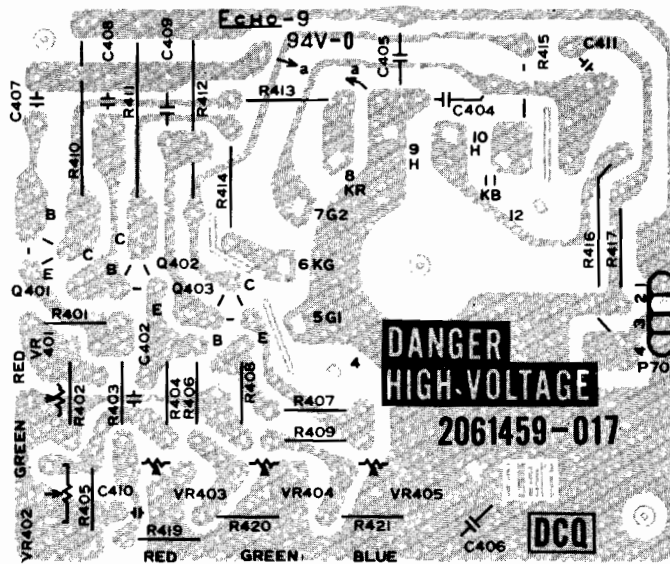

BOTTOM VIEW

FIGURE 12 NECK P.C. BOARD

MAIN BOARD (CONT.)

Ref. No.	Part No.	Description	Ref. No.	Part No.	Description
CAPACITORS (CONT.)			SEMICONDUCTORS (CONT.)		
C380	202X7200-087	470 uF, 500V Ceramic	Q206	200X3181-523	Transistor (NPN) 2SC1815GR
△ C501	203X1810-149	0.1 uF, 125V Mylar	Q207	200X3181-523	Transistor (NPN) 2SC1815GR
△ C502	202X7050-282	1500 pF, 500V Ceramic	Q208	200X3181-523	Transistor (NPN) 2SC1815GR
△ C503	202X7810-214	2200 pF, 125V Ceramic	Q209	200X3181-523	Transistor (NPN) 2SC1815GR
△ C504	202X7810-214	2200 pF, 125V Ceramic	Q210	200X3181-523	Transistor (NPN) 2SC1815GR
C505	203X0220-075	560 uF, 200V Electrolytic	Q301	200X3181-523	Transistor (NPN) 2SC1815GR
C506	203X0040-034	22 uF, 160V Electrolytic	Q302	200X3207-306	Transistor (NPN) 2SC2073LBGL2
C507	203X0041-057	47 uF, 160V Electrolytic	Q303	200X3207-306	Transistor (NPN) 2SC2073LBGL2
C701	203X0019-092	1000 uF, 25V Electrolytic	Q351	200X3248-217	Transistor (NPN) 2SC2482BK
C702	203X0634-061	10 uF, 100V Electrolytic	Q352	200X4589-802	Transistor (NPN) 2SD898B
C703	202X7050-248	1000 pF, 500V Ceramic	IC301	200X2300-033	IC HA11423
SEMICONDUCTORS			△★ IC501	200X2600-183	IC STR381
D203	201X2010-159	Diode, IS2076-27	L351	201X4710-134	Coil, (RF Choke)
D204	201X2010-159	Diode, IS2076-27	L352	201X5000-083	Coil, Horiz. Size
D205	201X2010-159	Diode, IS2076-27	L701	611X0004-007	Coil, Adg.
D206	201X2010-159	Diode, IS2076-27	T351	202X1300-080	Transformer, Hor. Drive
D207	201X2010-159	Diode, IS2076-27	△★ T352	200X9720-301	HV-Unit M-11
D208	201X2010-159	Diode, IS2076-27	△ F501	204X7120-073	Fuse, 4 Amp. 125V
D209	201X2010-159	Diode, IS2076-27	J402	206X5008-632	Recep W Wire 3P-M-BG
D301	201X2010-165	Diode, ISS81	P201	204X9600-466	Plug, PWB 3P-J
D302	201X2010-159	Diode, IS2076-27	P202	204X9601-477	Plug, PWB 6P-Q
D303	201X2010-159	Diode, IS2076-27	P401	204X9600-298	Plug, PWB 4P-B
D304	201X2120-009	Diode, RH-IV	P501	204X9600-249	Plug, PWB 2P-B
D305	201X2120-009	Diode, RH-IV	P601	204X9600-304	Plug, PWB 4P-C
D306	201X2010-159	Diode, IS2076-27	TH501	201X0100-112	Thermistor
△ D501	201X3120-216	Diode, RM-1AV	MISCELLANEOUS		
△ D502	201X3120-216	Diode, RM-1AV	FINAL ASSEMBLY PARTS		
△ D503	201X3120-216	Diode, RM-1AV	△★ 88X0138-506	19VLT22 Pix Tube	
△ D504	201X3120-216	Diode, RM-1AV	205X9800-158	Lateral/Purity Assembly	
D505	201X3120-216	Diode, RM-1AV	△★ 202X1111-201	Yoke Deflection	
D506	201X3120-216	Diode, RM-1AV	204X9301-255	CRT Socket	
D701	201X2130-234	Diode, RU-2V	291X5004-262	Automatic Degaussing Coil Unit	
D702	201X2120-009	Diode, RH-1V			
Q201	200X3181-523	Transistor (NPN) 2SC1815GR			
Q202	200X3181-523	Transistor (NPN) 2SC1815GR			
Q203	200X4056-260	Transistor (PNP) 2SA562-Y-TM			
Q204	200X4056-260	Transistor (PNP) 2SA562-Y-TM			
Q205	200X4056-260	Transistor (PNP) 2SA562-Y-TM			

NECK BOARD

RESISTORS			CAPACITORS		
R401	203X6000-729	220 Ohm, 5% 1/4W Carbon	C401	202X7050-269	1200 pF, 500V Ceramic
R402	203X6500-540	390 Ohm, 5% 1/4W Carbon	C402	202X7050-248	1000 pF, 500V Ceramic
R403	203X6000-661	820 Ohm, 5% 1/4W Carbon	C403	202X7050-248	1000 pF, 500V Ceramic
R404	203X6000-729	220 Ohm, 5% 1/4W Carbon	C404	202X7050-282	1500 pF, 1.5KV Ceramic
R405	203X6500-540	390 Ohm, 5% 1/4W Carbon	C405	202X7050-483	0.01 uF, 500V Ceramic
R406	203X6000-661	820 Ohm, 5% 1/4W Carbon	SEMICONDUCTORS		
R407	203X6000-729	470 Ohm, 5% 1/4W Carbon	Q401	200X3206-800	Transistor (NPN) 2SC2068LB
R408	203X6000-998	270 Ohm, 5% 1/4W Carbon	Q402	200X3206-800	Transistor (NPN) 2SC2068LB
R409	203X6000-661	820 Ohm, 5% 1/4W Carbon	Q403	200X3206-800	Transistor (NPN) 2SC2068LB
R410	203X9104-824	15K Ohm, 5% 2W M.O. Forming	MISCELLANEOUS		
R411	203X9104-824	15K Ohm, 5% 2W M.O. Forming	J401	206X5009-296	RECEP W Wire 4P-E
R412	203X9104-824	15K Ohm, 5% 2W M.O. Forming	P402	204X9600-254	Plug, PWB 3P-A
R413	203X6000-998	2.7K Ohm, 5% 1/2W Comp.	P403	204X9600-981	Plug, Pin 1P-D
R414	203X6000-998	2.7K Ohm, 5% 1/2W Comp.	P701	204X9601-020	Plug, PWB 4P-E
R415	203X6000-998	2.7K Ohm, 5% 1/2W Comp.			
R416	203X9105-154	2.2 Ohm, 5% 2W Metal Oxide			
R419	203X6500-741	2.7K Ohm, 5% 1/4W Carbon			
R420	203X6500-741	2.7K Ohm, 5% 1/4W Carbon			
R421	203X6500-741	2.7K Ohm, 5% 1/4W Carbon			
VR401	204X2115-014	500 Ohm, -B Semi-Fixed			
VR402	204X2115-014	500 Ohm, -B Semi-Fixed			
VR403	204X2115-006	5K Ohm, -B Semi-Fixed			
VR404	204X2115-006	5K Ohm, -B Semi-Fixed			
VR405	204X2115-006	5K Ohm, -B Semi-Fixed			

TYPICAL DC VOLTAGES

TRANSISTOR NO.	TERMINAL		
	COLLECTOR	BASE	EMITTER
Q201	8.1	0.43	0.36
Q202	9.8	8.1	9.3
Q203	0	0.35	1.0
Q204	0	0.35	1.0
Q205	0	0.35	1.0
Q206	9.7	5.5	4.8
Q207	9.7	5.5	4.8
Q208	9.7	5.5	4.8
Q209	15.4	-0.30	0.01
Q210	14.0	0.31	0.17
Q301	15.5	4.7	4.2
Q302	79	37.8	37.7
Q303	37	0.51	0
Q351	41.4	0.41	0
Q352	DO NOT MEASURE	-0.03	0
Q401	139	9.7	9.3
Q402	139	9.7	9.3
Q403	139	9.7	9.3

I.C. 301	
PIN NO.	VOLTAGE
1	1.16
2	4.0
3	6.8
4	3.9
5	12.1
6	4.1
7	4.1
8	1.9
9	12.2
10	14.2
11	3.6
12	7.9
13	6.8
14	12.8
15	1.52
16	0
17	0.83
18	0

I.C. 501	
PIN NO.	VOLTAGE
1	163
2	130
3	0
4	132

19" COLOR MONITOR SCHEMATIC DIAGRAM

MODELS 19K4901, 19K4906, 19K4951, 19K4956

Power Supply Voltage and Symbols

Symbol	Voltage	Operating Circuit
	15V	Vert. Osc. Sync Blanking CRT Cut-Off
	130V	Horiz. Osc. Horz. Drive Horz. Output Vert. Output
	175V	Video Output



SERVICE TECHNICIAN WARNING X-RAY RADIATION PRECAUTION:

THIS PRODUCT CONTAINS CRITICAL ELECTRICAL AND MECHANICAL PARTS ESSENTIAL FOR X-RAY RADIATION PROTECTION.
FOR REPLACEMENT PURPOSES, USE ONLY TYPE PARTS SHOWN IN THE PARTS LIST.



CAUTION: FOR CONTINUED SAFETY, REPLACE SAFETY CRITICAL COMPONENTS ONLY WITH MANUFACTURER'S RECOMMENDED PARTS.
AVERTISSEMENT: POUR MAINTENIR LE DEGRE DE SECURITE DE L'APPAREIL NE REMPLACER LES COMPOSANTS DONT LE FONCTIONNEMENT EST CRITIQUE POUR LA SECURITE QUE PAR DES PIECES RECOMMANDEES PAR LE FABRICANT.

OSCILLOSCOPE WAVEFORM PATTERN

The waveforms shown are as observed on the wide band oscilloscope with the monitor turned to a reasonably strong signal and a normal picture. The voltages shown on each waveform are the approximate peak amplitudes.

If the waveforms are observed on the oscilloscope with a poor high frequency response, the corner of the pulses will tend to be more rounded than those shown and the amplitude of any high frequency pulse will tend to be less.

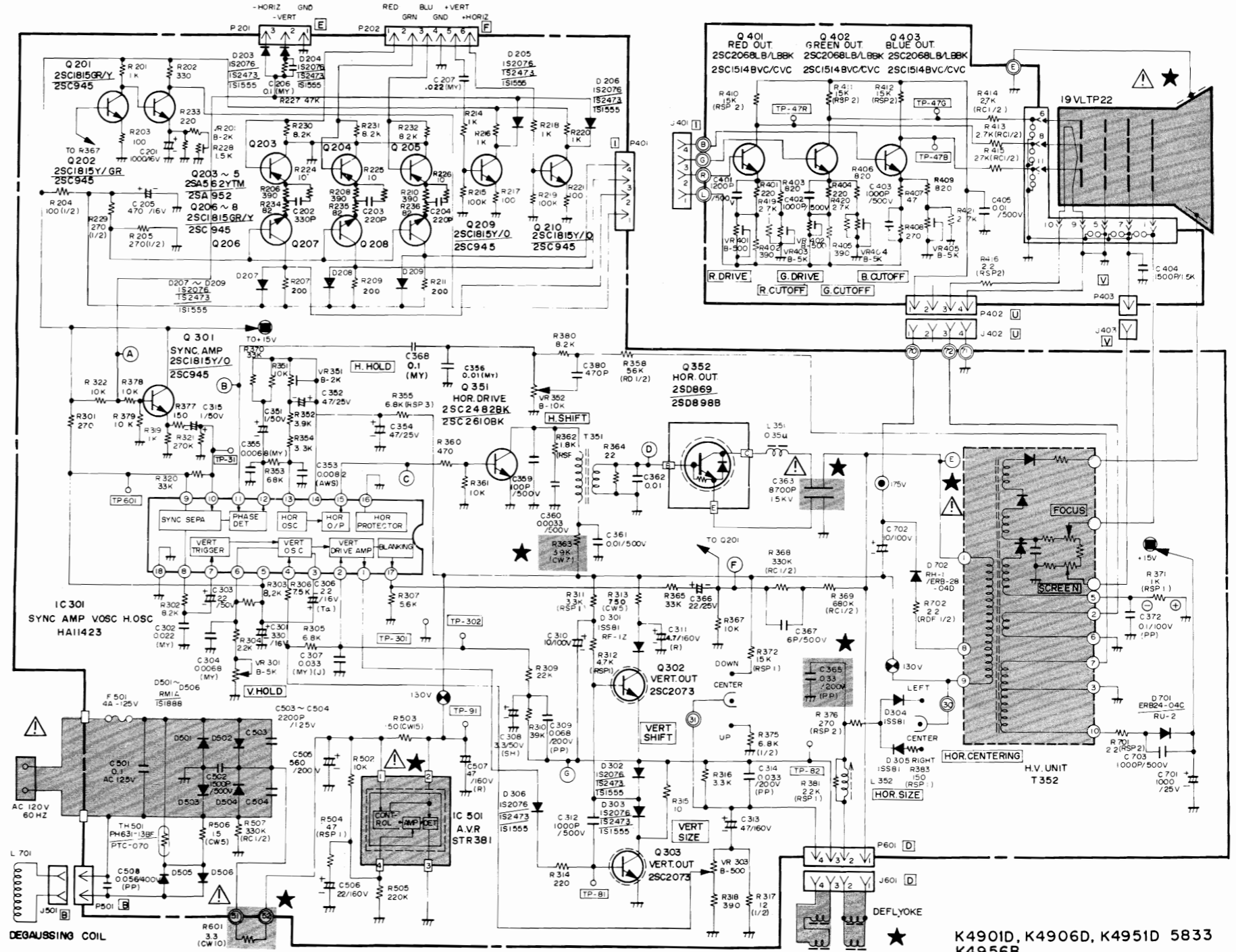
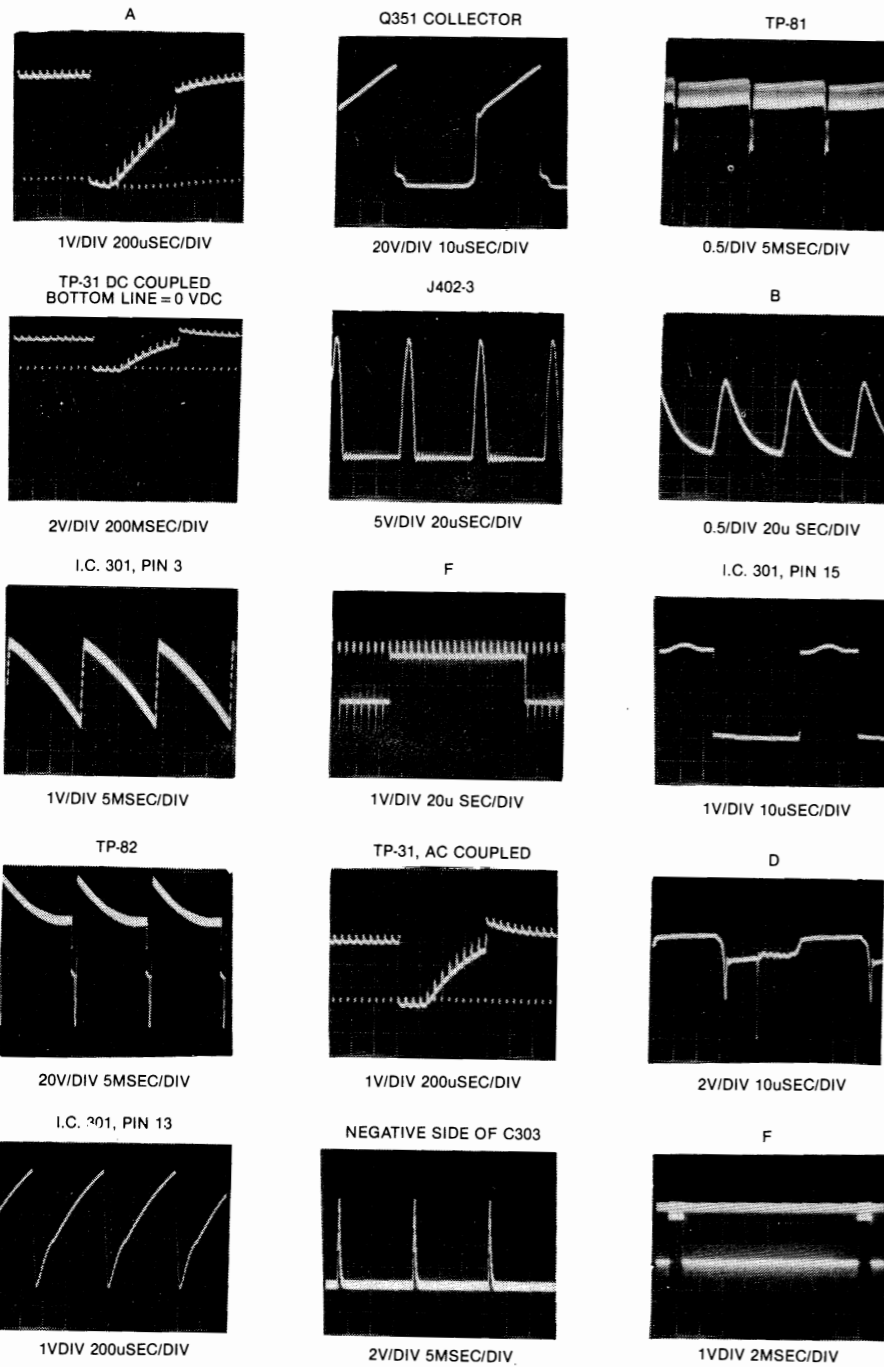

★ K4901D, K4906D, K4951D 5833
K4956B

SERVICE NOTES





LIMITED WARRANTY

Mylstar Electronics, Inc. warrants to the initial purchaser of the Mylstar Electronics, Inc. machine that the items listed in the following schedule as installed and used in the original Mylstar Electronics, Inc. machine will for the applicable period set forth in the schedule, computed from the initial date of purchase from an authorized Mylstar Electronics, Inc. distributor, be free of defects in materials and workmanship:

SCHEDULE

<u>GAME</u>	<u>ITEM</u>	<u>WARRANTY PERIOD</u>
Pinball	All Electronic Printed circuit boards	90 days
Pinball-Video	All Electronic Printed Circuit Boards	90 days
	Card Cage	90 days
	Television Monitor	30 days
Video	All Electronic Printed Circuit Boards	90 days
	Television Monitor	30 days

This Limited Warranty does not apply to any parts damaged in the course of handling or assembling by the customer or damage due to other than normal use or use in violation of instructions or reasonable practices, or further damaged in return shipment. This Limited Warranty is made only to the original customer, and is and shall be in lieu of all other warranties expressed or implied, and of all other obligations or liabilities on the part of Mylstar Electronics, Inc. and in no event shall Mylstar Electronics, Inc. be liable for any anticipated profits, consequential damages, loss of time, or other losses incurred by the customer in connection with the purchase or operation of Mylstar Electronics, Inc. machines or components thereof.

The registration card with each Mylstar Electronics, Inc. factory-wired machine must be filled in and returned to Mylstar Electronics, Inc. within ten days after date of purchase for this Limited Warranty to be effective. This Limited Warranty applies only to machines so registered.

THIS LIMITED WARRANTY IS IN LIEU OF ANY OTHER EXPRESS OR IMPLIED WARRANTIES, INCLUDING ANY IMPLIED WARRANTY OF MERCHANTABILITY OR FITNESS, AND OF ANY OTHER OBLIGATION ON THE PART OF THE SELLER AND MYLSTAR ELECTRONICS, INC.



**MYLSTAR
ELECTRONICS
INC.**



JUNO FIRST



**MYLSTAR
ELECTRONICS
INC.**

**165 West Lake Street
Northlake, Illinois 60164
Tel (312) 562-7400
Telex 72-8463**