

# NBA<sup>®</sup> HANGTIME<sup>™</sup> KIT

Information current at time of release.

Fill out and mail in game registration card. Be sure to include the game serial number. For your records, write the game serial number in the manual.

Serial Number \_\_\_\_\_

Midway Manufacturing Company reserves the rights to make modifications and improvements to its products.

The specifications and parts identified in this manual are subject to change without notice.

## TABLE OF CONTENTS

<b>Section 1 - Operation</b> .....	1-1
<b>Safety Notices</b> .....	1-2
<b>Notice - FCC Warning Notice</b> .....	1-3
<b>Epilepsy Warning</b> .....	1-3
<b>Conversion Procedure</b> .....	1-4
Inspection.....	1-4
Cabinet Modifications.....	1-5
Tools & Supplies .....	1-5
Control Panel Modifications .....	1-7
Install P.C.B. and Wiring into Jamma Cabinet.....	1-8
Install P.C.B. and Wiring into Non-Jamma Cabinet .....	1-9
<b>Game Features</b> .....	1-10
Starting-Up.....	1-10
Player Controls.....	1-10
Control Panel Diagram.....	1-10
<b>Menu System Operation</b> .....	1-11
Operation .....	1-11
Main Menu .....	1-11
Diagnostic Tests .....	1-12
Switch Test.....	1-12
DIP Switch Test & Table .....	1-13
Video Section Testing .....	1-14
Sound Section Testing .....	1-14
Monitor Patterns .....	1-15
Run Burn-in Test.....	1-15
Coin Bookkeeping.....	1-16
Game Audits .....	1-17
Game Adjustments .....	1-18
Standard Pricing Table .....	1-20
Custom Pricing.....	1-21
<b>Utilities</b> .....	1-22

<b>Hardware Info</b> .....	1-22
<b>Adjust Volume</b> .....	1-23
<b>Attract Mode Volume Adjust</b> .....	1-23
<b>Troubleshooting</b> .....	1-24
<b>Section 2 - Parts Information</b> .....	2-1
NBA HANGTIME CPU P.C.B. Drawing .....	2-2
NBA HANGTIME CPU P.C.B. Parts List .....	2-3
Push Button Assembly .....	2-4
Joystick Assembly .....	2-5
Notes .....	2-6
<b>Section 3 - Cabinet Wiring</b> .....	3-1
JAMMA Chart .....	3-2
Cabinet Wiring Diagram .....	3-3
Coin Switch and Meter Wiring .....	3-4
Control Panel Template (Player 1)	
Control Panel Template (Player 2)	
Control Panel Template (Player 3)	
Control Panel Template (Player 4)	

**NBA<sup>®</sup>**  
**HANGTIME<sup>™</sup>**  
**KIT**

SECTION  
ONE

---

**Operation**

## Safety Notices

The following safety instructions apply to all kit operators and service personnel. Specific warnings and cautions will be found throughout this manual where they apply. We recommend that you read this page, and also all of Section One, before preparing your kit for play.



### CAUTION

**Salvaged Parts.** Parts salvaged from old games are required to complete your kit. These salvaged parts must operate perfectly; otherwise, the converted game can not perform properly or safely. Always repair circuit board malfunctions and cabinet damage before conversion is attempted.

**Power Supply.** Be sure the power supply from your old game is capable of +5VDC at 5A, -5VDC at 1A, and +12VDC at 2A. All power supply voltages are  $\pm 5\%$ . These operating voltages are necessary for the kit. Your power supply must be FCC approved.

**Monitor.** This kit is not intended for use with X-Y monitors. Suitable monitors have horizontally mounted CRT-s and raster electronics with inputs for red, green and blue video, as well as Composite Negative Sync inputs.

**Coin Mechanism.** Be sure to clean and lubricate your old coin mechanisms. Servicing them is crucial to your game's earning potential and operation.

**Coin Meters.** Coin meters are not provided with this kit. Wiring information is provided as a convenience to the operator.

**Servicing/Installing.** Always turn your game OFF and unplug it before attempting to service or install your kit. Installing or repairing P.C. boards with power ON will void warranty.

### ATTENTION

**PROPERLY ATTACH ALL CONNECTORS.** *Make sure that the connectors on each printed circuit board (PCB) are properly connected. If the connectors do not slip on easily, do not force them. A reversed connector may damage your kit and void the warranty. All connectors are keyed to fit specific pins on each board.*

**NOTICE - FCC COMPLIANCE STICKER**

- I. **THIS KIT WAS TESTED IN A MIDWAY UNIVERSAL VIDEO CABINET (MODEL 40135) AND FOUND TO COMPLY WITH FCC PART 15 CLASS A REQUIREMENTS.** IF INSTALLED IN A MIDWAY UNIVERSAL VIDEO CABINET (MODEL 40135), THE FCC COMPLIANCE STICKER (16-10139) SUPPLIED IS TO BE PLACED ON THE REAR OF THE CABINET.
  
- II. **INSTALLATION OF THIS KIT INTO ANY OTHER PRODUCT DOES NOT GUARANTEE COMPLIANCE WITH FCC REQUIREMENTS.** YOU ARE SOLELY RESPONSIBLE, AND MIDWAY WILL HAVE NO RESPONSIBILITY FOR FCC COMPLIANCE FOR INSTALLATIONS IN OTHER PRODUCTS. THE FCC COMPLIANCE STICKER SUPPLIED SHOULD NOT BE INSTALLED ON THE CONVERTED PRODUCT UNTIL FCC COMPLIANCE IS VERIFIED.

**EPILEPSY WARNING**

A very small portion of the population has a condition which may cause them to experience epileptic seizures or have momentary loss of consciousness when viewing certain kinds of flashing lights or patterns that are commonly present in our daily environment. These persons may experience seizures while watching some kinds of television pictures or playing certain video games. People who have not had any previous seizures may nonetheless have an undetected epileptic condition.

If you or anyone in your family has experienced symptoms linked to an epileptic condition (e.g. seizure or loss of awareness), immediately consult your physician before using any video games.

We recommend that parents observe their children while they play video games. If you or your child experience any of the following symptoms: dizziness, altered vision, eye or muscle twitching, involuntary movements, loss of awareness, disorientation, or convolutions, DISCONTINUE USE IMMEDIATELY and consult your physician.

## Conversion Procedure

### Inspection

Unpack the materials from the carton and inspect for obvious signs of damage. Use this checklist to be sure your kit is complete.

	<u>Part number</u>	<u>Item Description</u>	<u>Qty.</u>
[ ]	A-20362	CPU FINAL ASSEMBLY-NBA HANGTIME	1
[ ]	H-17833	CONTROL PANEL CABLE	1
[ ]	H-17834	PLAYER 3 & 4 CABLE	1
[ ]	H-20295	MAIN HARNESS CABLE	1
[ ]	03-8338-1	P.C.B. MOUNTING SPACERS ¼"	8
[ ]	16-8587-825	FBI WARNING LABEL	1
[ ]	16-9478.2	REGISTRATION CARD	1
[ ]	19-9922.1	EPILEPSY WARNING LABEL	1
[ ]	16-9510	CREDIT DECAL	1
[ ]	16-9511	TOURNAMENT LABEL	1
[ ]	16-10151	CONTROL PANEL TEMPLATE	1
[ ]	16-10139	FCC/CANADA WARNING LABEL	1
[ ]	16-44059-101	MANUAL	1
[ ]	20-9620	T-20 LONG ARM KEY	1
[ ]	20-9978-1	RED JOYSTICK	2
[ ]	20-9978-3	BLUE JOYSTICK	2
[ ]	20-10209-1	RED PUSH BUTTON	4
[ ]	20-10209-2	WHITE PUSH BUTTON	4
[ ]	20-10209-3	BLUE PUSH BUTTON	4
[ ]	20-10209-7	ORANGE PUSH BUTTON	4
[ ]	31-1763	BEST VALUE DECAL	1
[ ]	31-1768	NBA HOLOGRAM DECAL	1
[ ]	31-1789	CLEAR OVERLAY	1
[ ]	31-2393-1	MARQUEE	1
[ ]	31-2394	INSTRUCTION CARD	1
[ ]	31-2397	CONTROL PANEL HOUSING DECAL SET	1
[ ]	31-2398	SIDE PANEL DECAL	2
[ ]	31-2399	CONTROL PANEL OVERLAY	1
[ ]	31-2400	CONTROL PANEL DECAL SET	1
[ ]	4108-01193-10B	#8 X 5/8" TAMPER RESISTANT SCREW	10
[ ]	4308-01123-24B	8 -32 X 1 ½" BOLT	16
[ ]	4408-01128-00	8-32 KEPS NUT	16

## Cabinet Modifications

### Recommended Tools and Supplies

- [ ] Black Semi-gloss Paint
- [ ] Electric Drill
- [ ] Electric Screwdriver
- [ ] Grease Pencil or Marker
- [ ] Hex Driver
- [ ] 180 Grit Sandpaper or Electric Sander
- [ ] Pliers
- [ ] Razor Knife
- [ ] Soldering Iron and Solder
- [ ] Wire Cutters
- [ ] Black Electrical Tape
- [ ] Quick-hardening Wood Putty

1. Fill in gouges with a good quick-hardening wood putty. Sand cabinet and wipe it clean.
  
2. Repaint the cabinet with black semi-gloss paint. For games with wood grain sides: remove old decals and clean the glue residue before painting. Allow paint to dry completely.
  
3. Pencil a line roughly at the top of the old graphic. Lightly moisten the cabinet with soapy water. Apply the decal starting at the top and working down. After the decal is in place, smooth it down, taking care to squeeze out air bubbles. If an air bubble is missed, pop it with a razor blade or a pin and smooth it down. Allow 12 hours for the adhesive on the decals to set.
  
4. Check the kit for an FCC sticker. If this kit is installed in a Midway universal video cabinet (model 40135), the FCC compliance sticker (16-10139) supplied is to be placed on the rear of the cabinet. Installation of this kit into any other product does not guarantee compliance with FCC requirements. The FCC compliance sticker supplied should not be installed on the converted product until FCC compliance is verified.

### **NOTICE - FCC COMPLIANCE STICKER**

- I. **THIS KIT WAS TESTED IN A MIDWAY UNIVERSAL VIDEO CABINET (MODEL 40135) AND FOUND TO COMPLY WITH FCC PART 15 CLASS A REQUIREMENTS. IF INSTALLED IN A MIDWAY UNIVERSAL VIDEO CABINET (MODEL 40135), THE FCC COMPLIANCE STICKER (16-10139) SUPPLIED IS TO BE PLACED ON THE REAR OF THE CABINET.**
  
- II. **INSTALLATION OF THIS KIT INTO ANY OTHER PRODUCT DOES NOT GUARANTEE COMPLIANCE WITH FCC REQUIREMENTS. YOU ARE SOLELY RESPONSIBLE, AND MIDWAY WILL HAVE NO RESPONSIBILITY FOR FCC COMPLIANCE FOR INSTALLATIONS IN OTHER PRODUCTS. THE FCC COMPLIANCE STICKER SUPPLIED SHOULD NOT BE INSTALLED ON THE CONVERTED PRODUCT UNTIL FCC COMPLIANCE IS VERIFIED.**



5. Remove viewing glass and apply the game play instruction decal to the front of the monitor bezel. Be sure the decal does not obstruct the CRT. Apply the NBA Hologram on the lower right corner of the monitor bezel.
  
6. Place Epilepsy Warning Label on the front of the monitor bezel. Be sure that it does not obstruct the CRT screen but is in full view of the players.
  
7. Remove the marquee from the game cabinet and install the NBA Hangtime marquee in its place.

## Control Panel Modifications

**IMPORTANT:** Placement of joysticks must be horizontal to the control panel for proper playing capability. Use template (16-10151) from kit, as a guide.

1. Remove control panel buttons, joysticks and old control panel artwork.
2. Use the full control panel template to design the control panel. Separate templates are located on the last pages of this manual.
3. Plug previous holes with wood blocks, putty, cardboard or epoxy. Drill new holes as needed for joysticks and control panel buttons. File new holes smooth.
4. Carefully remove the backing on the control panel overlay. Place overlay on top of control panel. Prevent air bubbles from getting under overlay.
5. After the overlay is on securely, use a razor knife to trim excess and to cut holes for control panel buttons and joysticks. Then position stickers around the appropriate locations.
6. Being careful not to displace the stickers, place the clear overlay on the control panel. Use the torx head tamper resistant screws and the flat washers to attach the clear overlay to the control panel. Once the clear overlay is securely in place, cut holes for the joysticks and control panel buttons.
7. Remove switch from push button; grasp switch firmly on the left and right sides and squeeze prongs together, (do not grasp switch by the solder lugs). Carefully pull switch from housing. Unscrew nut from housing. Push switch housing through control panel from the front. Screw nut back onto switch housing from the back of the control panel. Carefully push switch back into switch housing.
8. To install the joysticks, remove the e-ring and slide the shaft and plastic ring off the joystick base. Be sure that the bushings remain in the base. Use the 8-32 bolts and the 8-32 nuts to attach the base to the underside of the control panel. Slide the plastic ring around the shaft so that the rough side is next to the shaft handle. Slide the shaft through the control panel and base. Replace the e-ring.

## Joystick/Push Button Layout

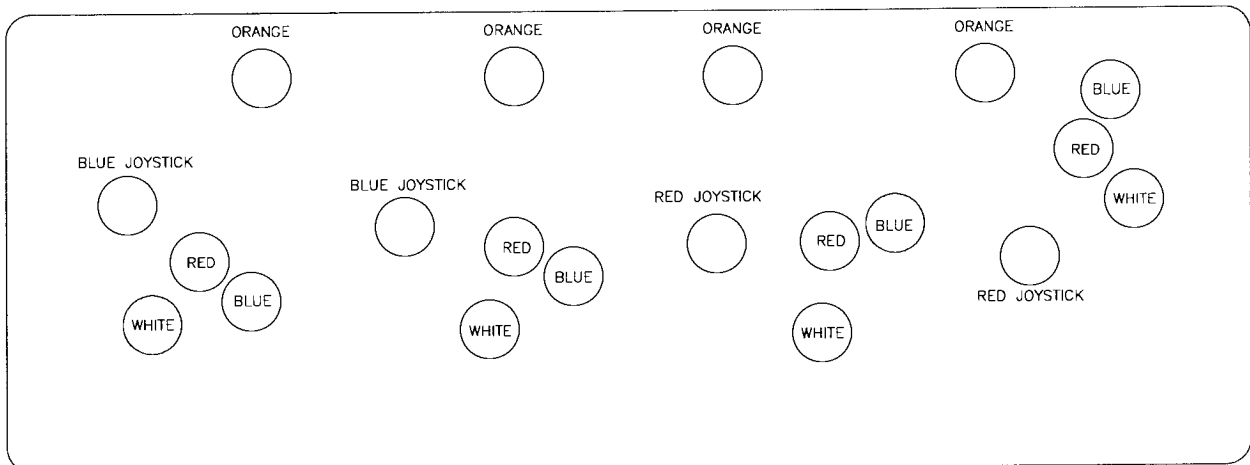

## INSTALL PC BOARD AND WIRING INTO A JAMMA CABINET

1. Replace the existing CPU board and sound board with the NBA HANGTIME CPU board. Use the 1/4" P.C.B. mounting spacers and surplus screws to secure the board to the electronic rack, or to the inside wall of the cabinet.

2. If using the JAMMA cable provided with the kit, disconnect the old JAMMA cable from the speaker, power supply, control panel switches (which may already be disconnected) and the coin door. Remove the cable from the game. Leave the power chassis as is. **Note: If you choose to use your own JAMMA cable, check the JAMMA chart to be sure you cable is compatible.**

### CAUTION

**Properly insulate any unused wires within the JAMMA cable, especially the red, orange and yellow wires. This is a fully wired JAMMA cable. Many of the wires will not be used for this kit. These wires have been installed so that you can use this cable for future kits.**

The operating voltages from the power supply should be as follows:

+5V @	5 Amp	(Red Wires)
-5V @	0.5 Amp	(Yellow Wires)
+12V @	2.0 Amp	(Orange Wires)

Note: All power supply voltages are  $\pm 5\%$ .

3. Connect the JAMMA cable to the CPU board. Using the Cabinet Wiring Diagram for reference, solder the correct JAMMA cable wires to the speaker. Then, connect the wires to the coin door, power supply and the control panel. Player 1 has white-'color stripe' wires, except for the start button, which has a solid white wire. Player 2 has violet-'color stripe' wires. Use the Cabinet Wiring Diagram in section 3 for reference when connecting these wires to the player 1 and 2 control panel switches.

4. Connect the blue-'color-striped' wires to P12 of the CPU board. Use the Cabinet Wiring Diagram in section three for reference when connecting these wires.

5. Place the FBI Warning Label next to the CPU board. Be sure the label is completely visible.

6. Place the Copyright label next to the CPU Board. Be sure label is visible.

### **NOTICE - FCC COMPLIANCE STICKER**

I. **THIS KIT WAS TESTED IN A MIDWAY UNIVERSAL VIDEO CABINET (MODEL 40135) AND FOUND TO COMPLY WITH FCC PART 15 CLASS A REQUIREMENTS. IF INSTALLED IN A MIDWAY UNIVERSAL VIDEO CABINET (MODEL 40135), THE FCC COMPLIANCE STICKER (16-10139) SUPPLIED IS TO BE PLACED ON THE REAR OF THE CABINET.**

II. **INSTALLATION OF THIS KIT INTO ANY OTHER PRODUCT DOES NOT GUARANTEE COMPLIANCE WITH FCC REQUIREMENTS. YOU ARE SOLELY RESPONSIBLE, AND MIDWAY WILL HAVE NO RESPONSIBILITY FOR FCC COMPLIANCE FOR INSTALLATIONS IN OTHER PRODUCTS. THE FCC COMPLIANCE STICKER SUPPLIED SHOULD NOT BE INSTALLED ON THE CONVERTED PRODUCT UNTIL FCC COMPLIANCE IS VERIFIED.**

## INSTALL PC BOARD AND WIRING INTO A NON-JAMMA CABINET

1. Replace the existing CPU board and sound board with the NBA HANGTIME CPU board. Use the 1/4" P.C.B. mounting spacers and surplus screws to secure the CPU board to the electronic rack, or to the inside wall of the cabinet.
2. Leaving several inches of wire, cut the wires at the coin door, control panel switches (which already may be disconnected, speaker and power supply. Remove the harness from the cabinet. Leave the power chassis as is. **Note: Be sure that all spliced wires are well insulated with black electrical tape.**

The operating voltages from the power supply should be as follows:

+5V @	5 Amp	(Red Wires)
-5V @	0.5 Amp	(Yellow Wires)
+12V @	2.0 Amp	(Orange Wires)

Note: All power supply voltages are  $\pm 5\%$ .

3. Install the JAMMA cable provided with the kit. Players 1 and 2, the coin door and the power supply wires are bundled together in individual groups. Insure that the cable is properly dressed and supported.

### CAUTION

Properly insulate any unused wires within the JAMMA cable, especially the red, orange and yellow wires. This is a fully wired JAMMA cable. Many of the wires will not be used for this kit. These wires have been installed so that you can use this cable for future kits.

4. Connect the JAMMA cable to the CPU board. Use the Cabinet Wiring Diagram for reference and solder the correct JAMMA cable wires to the speaker. Then, connect the wires to the coin door, power supply and the control panel. Player 1 has white-'color stripe' wires, except for the start button, which has a solid white wire. Player 2 has violet-'color stripe' wires. Use the Cabinet Wiring Diagram in section three for reference when connecting these wires to the player 1 and 2 control panel switches.
5. Connect the blue-'color-striped' wires to P12 of the CPU board. Use the Cabinet Wiring Diagram in section three for reference when connecting these wires.
6. Place the FBI Warning Label next to the CPU board. Be sure the label is completely visible.
7. Place the Copyright label next to the CPU Board. Be sure label is visible.

### NOTICE - FCC COMPLIANCE STICKER

- I. THIS KIT WAS TESTED IN A MIDWAY UNIVERSAL VIDEO CABINET (MODEL 40135) AND FOUND TO COMPLY WITH FCC PART 15 CLASS A REQUIREMENTS. IF INSTALLED IN A MIDWAY UNIVERSAL VIDEO CABINET (MODEL 40135), THE FCC COMPLIANCE STICKER (16-10139) SUPPLIED IS TO BE PLACED ON THE REAR OF THE CABINET.
- II. INSTALLATION OF THIS KIT INTO ANY OTHER PRODUCT DOES NOT GUARANTEE COMPLIANCE WITH FCC REQUIREMENTS. YOU ARE SOLELY RESPONSIBLE, AND MIDWAY WILL HAVE NO RESPONSIBILITY FOR FCC COMPLIANCE FOR INSTALLATIONS IN OTHER PRODUCTS. THE FCC COMPLIANCE STICKER SUPPLIED SHOULD NOT BE INSTALLED ON THE CONVERTED PRODUCT UNTIL FCC COMPLIANCE IS VERIFIED.

# Game Features

**NBA HANGTIME is a one to four player game.**

## Starting Up

Switch ON power to the game. A "rug" pattern appears on the CRT screen. When the "rug" pattern ends, the screen shows a CPU Board map. Bad chips are indicated in red, good chips are in green. The software revision level is shown at the top of the screen.

**NOTE:** When an error is detected during Start-up Tests, game start-up does not progress, and an error message appears on the screen.

Insert the desired amount of coins or tokens. Select which player received the credit by pressing the appropriate Start Button.

## Player Controls

- **Start Button (Orange)**
- **Shoot/Block Button (Red)**
- **Pass/Steal Button (Blue)**
- **Turbo Button (White)**
- **Joystick (Blue, Red)**

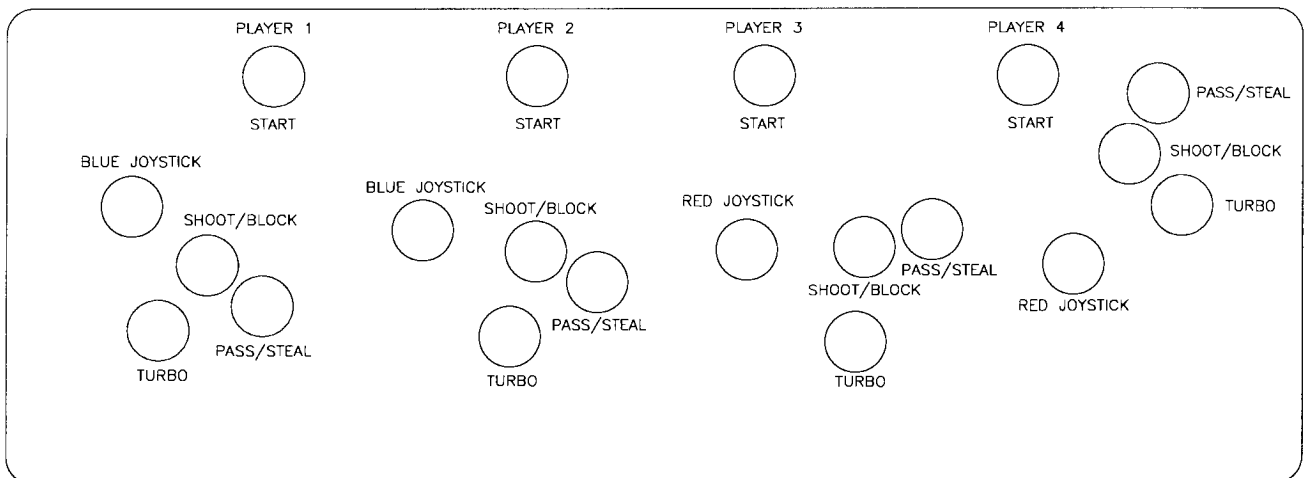

## Menu System Operation

### OPERATION

All Game Audits, Adjustments, and Diagnostics are options of the Main Menu. Each option, in turn, has its own menu, listing several choices that may be acted upon as desired.

To activate the Main Menu (shown below), press the test mode switch, or set DIP Switch #1, Switch 1 to the ON position. Game adjustments, bookkeeping, and diagnostics are all accessible from this menu.

Use any joystick to select desired menu option; press any control panel button to activate it. Notice that the options are highlighted in sequence.

**Note:** Only highlighted options can be activated.

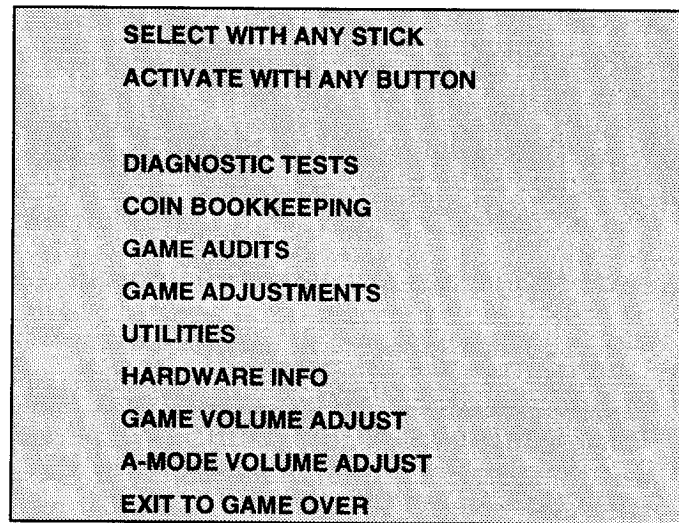

Main Test Menu

## DIAGNOSTIC TESTS

To enter Diagnostic Tests from the Main Menu, use any joystick to select the option; press any control panel button to activate.

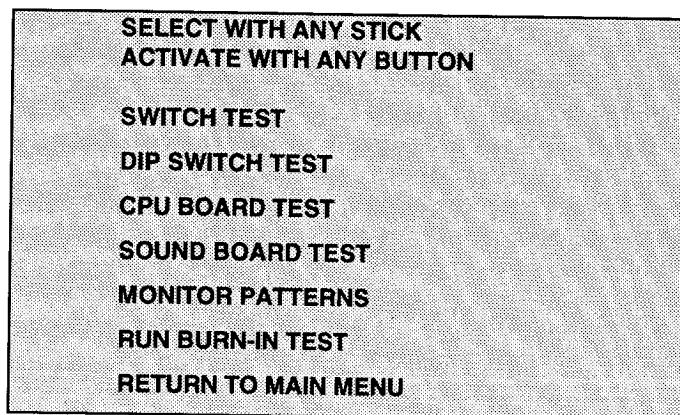

Diagnostic Test Menu

### Switch Test

The Switch Test allows the operator to test the switches on the control panel and the coin door.

Select the Switch Test by using any joystick to select the option; then press any control panel button to activate. Pressing a switch on the control panel or coin door causes the corresponding switch location on the screen to light.

To exit switch test screen, press start 1 and start 2 button simultaneously.

## Dip Switch Test

The DIP Switch Test allows the operator to check the location of the two 8-position DIP switches on the CPU Board. The operator can also change the setting of each position of each DIP Switch during this mode.

To enter the test, use any joystick to select the option; press any control panel button to activate. The screen displays a layout of current DIP Switch settings.

To change a DIP Switch setting, move the switch to the desired setting, then check the screen to verify that the switch now shows the new setting.

Press any control panel button to exit the Dip Switch Test.

**DIP Switch 1 Setting Table**

	SW1	SW2	SW3	SW4	SW5	SW6	SW7	SW8
Test Switch	Off* On							
Powerup Test		Off* On						
Not Used			Off* On	Off* On	Off* On	Off* On		
No Dollar Bill Validator Dollar Bill Validator Installed							Off* On	
4 Player Kit 2 Player Kit								Off* On

**DIP Switch 2 Setting Table**

	SW1	SW2	SW3	SW4	SW5	SW6	SW7	SW8
One Coin Counter, 1Count/Coin	Off*	Off*						
One Coin Counter, Totalizing	On	Off						
Two Coin Counters, 1Count/Coin	Off	On						
One Coin Counter, 1Count/Coin	On	On						
Country								
USA			Off*	Off*				
French			On	Off				
German			Off	On				
Unused			On	On				
Coinage								
USA1 Ger1 Fr1					Off*	Off*	Off*	
USA2 Ger2 Fr2					Off	Off	On	
USA3 Ger3 Fr3					Off	On	Off	
USA4 Ger4 Fr4					Off	On	On	
USAECA GerECA FrECA					On	Off	Off	
N/U N/U N/U					On	Off	On	
N/U N/U N/U					On	On	Off	
Free Play Free Play Free Play					On	On	On	
DIP Switch Coinage								Off*
CMOS Coinage								On

\*Indicates factory setting



### **Video Section Testing**

The Video Section Test (much like the Start-up Test) allows the operator to check the RAMs and ROMs.

Highlight the Video Section Test by using any joystick to select the option; then press any control panel button to activate. When this test is activated, a "rug" pattern appears on the screen. The screen then changes to show the layout of the RAMs and ROMs on the CPU. Any chip shown as gray with a white outline should turn green during the CPU Test. During the test, chips are good if they turn green; they are faulty if they turn red.

Press any control panel button to exit the Video Section Test.

### **Sound Section Testing**

The Sound Test allows listening to some of the sounds that the game is capable of producing.

To enter the test, use any joystick to select the option; then press any control panel button to activate.

<b>SELECT WITH ANY STICK</b> <b>ACTIVATE WITH ANY BUTTON</b>
<b>GENERAL TEST</b> <b>PLAY SOUNDS</b> <b>BACK TO DIAGNOSTIC MENU</b> <b>RETURN TO MAIN MENU</b>

**Sound Section Testing Menu**

### Monitor Patterns

The Monitor Patterns Test provides a menu for testing the monitor. Highlight the test by using any joystick to select the option; then press any control panel button to activate.

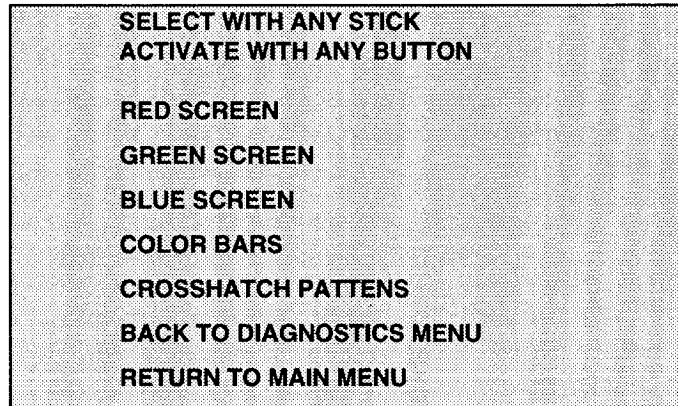

**Monitor Patterns Menu**

The **RED**, **GREEN**, and **BLUE SCREEN** tests fill the screen with either red, green or blue.

The **COLOR BARS** test fills the screen with several gradated colors to help with red, green and blue level adjustments. Each color should appear sharp and clear. A total of 15 color bars should be displayed.

The **CROSSHATCH PATTERNS** test fills the screen with a grid and should be clear.

If any of the Monitor Pattern Tests shows a need for adjustment, use the proper controls on the Monitor Board.

### Run Burn-in Test

The Burn-in Test continually repeats the Video Section Test. Use any joystick to select the option; then press any control panel button to activate. When the Burn-in Test detects an error, the test stops and displays an error message on the screen. Use this test to find intermittent CPU problems.

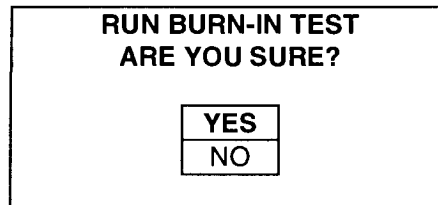

To exit this test, switch the game OFF then ON again.

## COIN BOOKKEEPING

The Coin Bookkeeping Table records the coin box totals and game play counters. The left side of the table names the bookkeeping item; the right side shows the number of coins, credits or plays for each item.

Highlight Coin Bookkeeping by using any joystick to select the option; then press any control panel button to activate.

LEFT SLOT COINS	0
RIGHT SLOT COINS	0
CENTER SLOT (3) COINS	0
EXTRA SLOT (4) COINS	0
BILL VALIDATOR	0
ATTRACT MODE STARTS	0
PAID CREDITS	0
MID GAME STARTS	0
TOTAL COLLECTION	\$0.00
SERVICE CREDITS	0
TOTAL PLAYS	0
NEXT AUDIT PAGE	
RETURN TO MAIN MENU	

Coin Bookkeeping Table

## GAME AUDITS

The Game Audits Table records the game play statistics. The left side of the table names the Audit item; the right side shows the amount of play.

TOTAL GAME UPTIME (Hrs:Mins)	00:00
TOTAL GAME PLAY TIME (Hrs:Mins)	00:00
GAMES STARTED	0
INDIVIDUAL PLAYER STARTS	0
INITIALS ENTERED	0
FULL GAMES PURCHASED	0
1 PLAYER PLAY	0
2 PLAYER PLAY	0
3 PLAYER PLAY	0
4 PLAYER PLAY	0
FINISHED 1ST QUARTER	0
FINISHED 2ND QUARTER	0
FINISHED 3RD QUARTER	0
FINISHED 4TH QUARTER	0
GONE TO OVERTIME	0
CREATED A PLAYER	0
NEXT AUDIT PAGE	
RETURN TO MAIN MENU	

Page 1 of Audit Table

**GAME AUDITS Continued**

SND ERR (DAV & READ BACK)	0
DOGS	0
PROCESS KO	0
AVERAGE SCORE	0
AVERAGE HUMAN SCORE	0
AVERAGE CPU SCORE	0
AVERAGE WINNING SCORE	0
AVERAGE LOSING SCORE	0
CPU VICTORIES	0
GREATEST CPU VICTORY MARGIN	0
GREATEST CPU LOSS MARGIN	0
SCORE DIFFERENTIAL AT DROPOUT	0
HUMAN VS. HUMAN-GAMES PLAYED	0
LSW	0
TOTAL HOT STREAKS STARTED	0
AVERAGE PTS SCORED ON HOT STREAKS	0
NEXT AUDIT PAGE	
PREVIOUS AUDIT PAGE	

Page 2 of Audit Table

ATLANTA	0	MINNESOTA	0
BOSTON	0	JEW JERSEY	0
CHARLOTTE	0	NEW YORK	0
CHICAGO	0	ORLANDO	0
CLEVELAND	0	PHILADELPHIA	0
DALLAS	0	PHOENIX	0
DENVER	0	PORTLAND	0
DETROIT	0	SACRAMENTO	0
GOLDEN STATE	0	SAN ANTONIO	0
HOUSTON	0	SEATTLE	0
INDIANA	0	TORONTO	0
L.A. CLIPPERS	0	UTAH	0
L.A. LAKERS	0	VANCOUVER	0
MIAMI	0	WASHINGTON	0
MILWAUKEE	0		
RETURN TO MAIN MENU			
PREVIOUS AUDIT PAGE			

Page 3 of Audit Table

## GAME ADJUSTMENTS

The Game Adjustment menu option allows the owner/operator to change the Game Pricing and Game Difficulty. The activated item provides a setting choice. Highlight setting choice with any joystick, then press any button to lock setting.

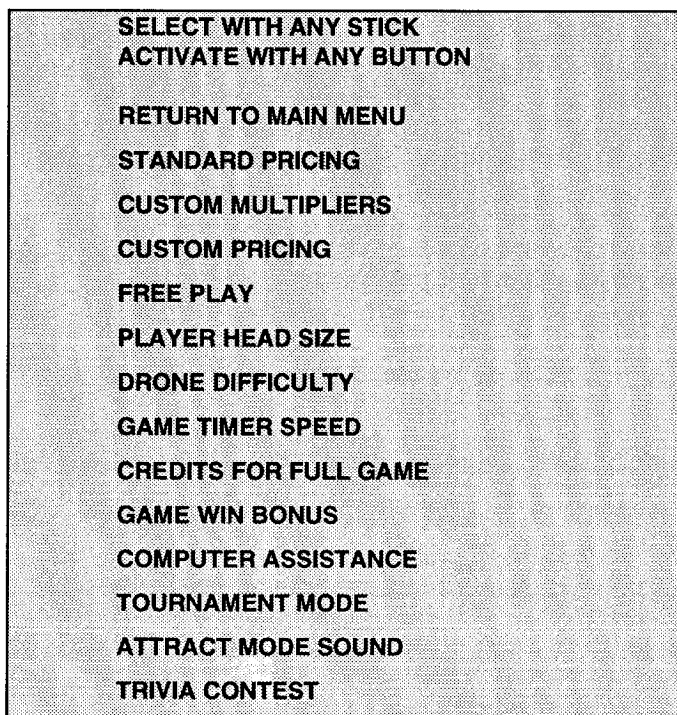

Game Adjustment Menu

### Standard Pricing

Standard Pricing allows the operator to choose any of the "Standard" selections for the Standard Pricing Table.

### Custom Multipliers

Customize the internal coin chute multipliers for each chute.

### Custom Pricing

Custom Pricing allows the operator to install pricing other than that of the Standard Pricing Table. Custom Pricing also allows the operator to select the amount of credits required to start a game and the amount of credits required to continue a game. This option is enabled via the Dip Switch Settings (set Dip Switch 2, SW8 to ON). The game must be set for CMOS Coinages for this feature to work.

### Free Play

This option selects free play. The setting choices for this adjustment are:

- No (factory)
- Yes

### Player Head Size

This controls the head size for players in the game.

- Normal Size: 1 (factory)
- Large Size: 2

### **Drone Difficulty**

This controls the skill level of the computer controlled players.

- Easiest Setting: 1
- Hardest Setting: 5
- Factory Setting: 3**

### **Game Timer Speed**

Game Timer allows the operator to control the overall game timer speed. The settings for the adjustment are:

- Slowest Setting: 1
- Fastest Setting: 5
- Factory Setting: 3**

### **Credits for Full Game**

Allows purchasing a full game at a discount from normal start/buyin pricing.

- Minimum Setting: 4
- Maximum Setting: 16
- Factory Setting: 8**

### **Game Win Bonus**

Allows the winning team to play the next game for free. Only the challenging team pays.

- On (factory)
- Off

### **Computer Assistance**

When enabled, computer keeps game scoring close.

Factory Setting: Enabled

### **Tournament Mode**

When in Tournament Mode, CPU assistance is turned off and no power-ups or special guests are allowed! No Cheating!

Factory Setting: Disabled

### **Attract-Mode Sounds**

Determines whether the game will make sounds in the attract mode. The settings for the adjustment are:

- On
- Off (factory)

### **Trivia Contest**

Determines whether the game will allow the Trivia Contest at Game Over.

- On factory)
- Off

## Standard Pricing Table

NAME	Settings Credit/Coin	COIN 1	COIN 2	COIN 3	COIN4	Bill
USA1	1/25¢ (2 to Start; 2 to Continue)	.25¢	25¢			\$1.00
USA2	1/25¢ (2 to Start; 1 to Continue)	.25¢	25¢			\$1.00
USA3	1/25¢ (1 to Start; 1 to Continue)	.25¢	25¢			\$1.00
USA4	1/50¢, 3/\$1.00 (1 to Start; 1 to Continue)	.25¢	25¢			\$1.00
USA5	1/50¢, 4/\$1.00 (2 to Start; 1 to Continue)	.25¢	25¢			\$1.00
USA6	1/50¢ (1 to Start; 1 to Continue)	.25¢	25¢			\$1.00
USA7	1/50¢, 3/\$1.00 (1 to Start; 1 to Continue)	.25¢	25¢			\$1.00
USA8	1/50¢, 4/\$1.00 (2 to Start; 2 to Continue)	.25¢	25¢			\$1.00
USA9	1/25¢, 4/\$1.00 (2 to Start; 2 to Continue)	.25¢	25¢			\$1.00
USA10	1/25¢, 4/\$1.00 (3 to Start; 2 to Continue)	.25¢	25¢			\$1.00
USA ECA	1/25¢, 4/\$1.00 (3 to Start; 3 to Continue)	\$1.00	25¢	.10¢	.05¢	\$1.00
GERMAN1	1/1DM, 6/5DM	1DM	5DM			
GERMAN2	1/1DM, 7/5DM	1DM	5DM			
GERMAN3	1/1DM, 8/5DM	1DM	5DM			
GERMAN4	1/1DM, 5/5DM	1DM	5DM			
GERMAN5	1/1DM, 6/5DM	1DM	5DM			
GERMAN ECA	1/1DM, 2/2DM, 6/5DM	5DM	2DM	1DM		
FRANCE1	2/5F, 5/10F	5F	10F			
FRANCE2	2/5F, 4/10F	5F	10F			
FRANCE3	1/5F, 3/10F	5F	10F			
FRANCE4	1/5F, 2/10F	5F	10F			
FRANCE5	2/5F, 5/10F, 11/2 X 10F	5F	10F			
FRANCE6	2/5F, 4/10F, 9/2 X 10F	5F	10F			
FRANCE7	1/5F, 3/10F, 7/2 X 10F	5F	10F			
FRANCE8	1/5F, 2/10F, 5/2 X 10F	5F	10F			
FRANCE9	1/3 X 1F, 2/5F	1F	5F			
FRANCE10	1/2 X 1F, 3/5F	1F	5F			
FRANCE11	1/3 X 1F, 2/5F, 5/2 X 5F	1F	5F			
FRANCE12	1/2 X 1F, 3/5F, 7/2 X 5F	1F	5F			
FRANCE ECA	1/3 X 1F, 2/5F, 5/2 X 5F		5F	10F	20F	
CANADA	1/2X25¢, 3/\$1.00	.25¢	\$1.00			\$1.00
SWISS1	1/1F, 6/5F	1F	5F			
SWISS2	1/1F, 7/5F	1F	5F			
SWISS3	1/1F, 8/5F	1F	5F			
ITALY	1/500LIRE	500 LIRE	500 LIRE			
UK1	1/20P, 3/50P	20P	50P			
UK2	2/20P, 5/50P	20P	50P			
UK ECA1	1/20P, 3/50P, 7/£1.00	£1.00	50P	20P	10P	
UK ECA2	1/20P, 3/50P, 7/£1.00	£1.00	50P	20P	10P	
UK ECA3	1/30P, 2/50P, 4/£1.00	£1.00	50P	20P	10P	
UK ECA4	1/30P, 2/50P, 5/£1.00	£1.00	50P	20P	10P	
UK ECA5	1/50P, 2/£1.00	£1.00	50P	20P	10P	
UK ECA6	1/50P, 3/£1.00	£1.00	50P	20P	10P	
UK ECA7	3/£1.00	£1.00	50P	20P	10P	
UK ELEC W/CCU	1/30P, 2/50P, 4/£1.00	£1.00	CCU			
SPAIN1	1/100PESETA, 6/500PESETA	100PESETA	500PESETA			
SPAIN2	1/100PESETA, 5/500PESETA	100PESETA	500PESETA			
AUSTRALIA1	1/3X20¢, 2/\$1.00	.20¢	\$1.00			
AUSTRALIA2	1/5X20¢, 1/\$1.00	.20¢	\$1.00			
JAPAN1	1/100YEN	100 YEN	100 YEN			
JAPAN2	2/100YEN	100 YEN	100 YEN			
AUSTRIA1	1/5SCHIL, 2/10SCHIL	5 schilling	10 schilling			
AUSTRIA2	1/2X5SCHIL, 3/2X10SCHIL	5 schilling	10 schilling			
BELGIUM1	1/20F	20F	20F			
BELGIUM2	3/20F	20F	20F			
BELGIUM3	2/20F	20F	20F			
BELGIUM ECA	1/20F	50F	20F	5F		
SWEDEN	1/3X1KRONA, 2/5KRONA	1 KRONA	5 KRONA			
NEW ZEALAND1	1/3X20¢	20¢	20¢			
NEW ZEALAND2	1/2X20¢	20¢	20¢			
NETHERLANDS	1/1HFI, 3/2.5HFI	1HFI	2.5HFI			
FINLAND	1/1MARKKA	1MARKKA	1MARKKA			
NORWAY	1/2X1KRONE, 3/5X1KRONE	1KRONE	1KRONE			
DENMARK	1/2X1KRONE, 3/5KRONE, 7/2X5KRONE	1 KRONE	5 KRONE			
ANTILLIES	1/25¢, 4/1GUILDER	.25¢	1GUILDER			
HUNGARY	1/2X10FORINT, 3/2X20FORINT	10FORINT	20FORINT			

## Custom Pricing

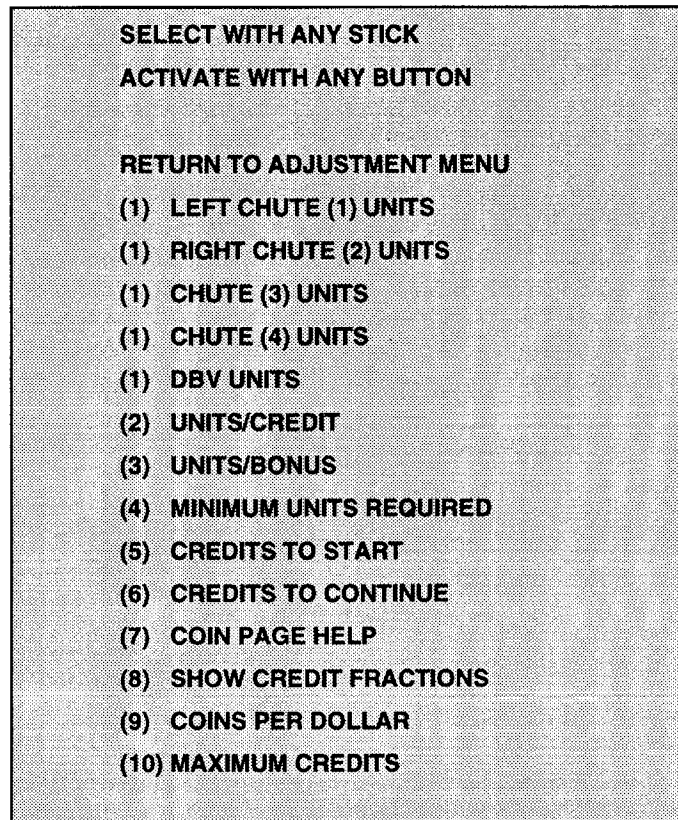

### Custom Pricing Menu

- (1) Coins inserted accumulate units. This adjustment specifies the number of units given for each coin in the left, right, 3rd, 4th, or bill validator chute (see "units/credit").
- (2) This is the number of coin units required to buy one credit.
- (3) One bonus credit is awarded after this many coin units have accumulated.
- (4) No credits will be awarded until this many coin units have accumulated.
- (5) Each player needs this many credits to begin a game.
- (6) Each player needs this many credits to continue a game.
- (7) Whenever standard pricing is used, a corresponding message is displayed on the credits screen. Setting this to no disables the message.
- (8) When set to yes, fractional credits will be seen on the credits screen.
- (9) The detailed bookkeeping screen shows total collections based on this many coins per dollar. (Set to zero to disable the display of money totals.)
- (10) This is the limit for the credits counter. Additional coins inserted will be lost. Factory setting is 30.



## UTILITIES

The Utilities Menu allows the owner/operator to clear the games bookkeeping memory and to install a custom message. Highlight selection with any joystick, then press any button to lock setting.

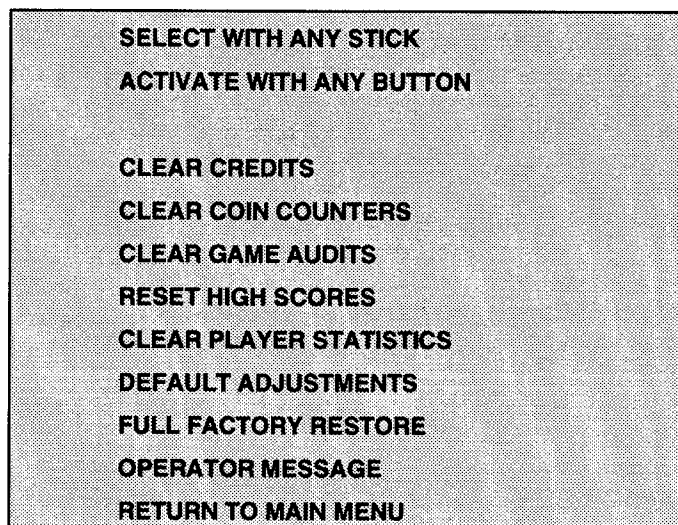

Utilities Menu

After an item has been activated, you are given the option of resetting that item or not. For example:

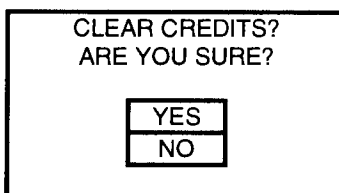

Highlight setting choice with any joystick, then press any button to lock setting and return to the Utilities Menu.

## HARDWARE INFO

Displays the name of the game, the serial number and manufacture date.

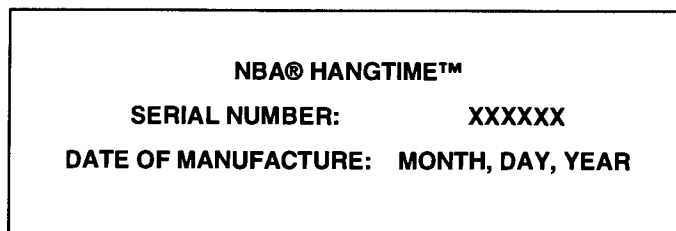

Press any control panel button to exit to the main menu.

## ADJUST VOLUME

Move any joystick up to increase, or down to decrease the sound level of the game. Press any control panel button to lock the volume level and return to the Main Menu.

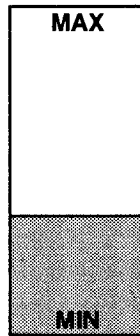

Press any control panel button to exit to the main menu.

## ATTRACT MODE VOLUME ADJUST

Move any joystick up to increase, or down to decrease the sound level in the Attract Mode. Press any control panel button to lock the volume level and return to the Main Menu.

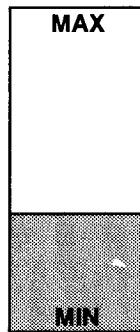

Press any control panel button to exit to the main menu.

## Troubleshooting

### PROBLEM

### POSSIBLE SOLUTION

NO PICTURE OR DISTORTED PICTURE.

Check for faulty video board or monitor. Check for disconnected video signal cable.

TURN GAME ON & NOTHING HAPPENS.

Check line fuse. Check for +5VDC at pins C, D, 3, and 4 of the JAMMA Connector. Check to see that the proper AC line voltage is selected for Switching Power Supply operation.

NO SOUND.

Check the speaker and speaker connection to pins L and 10 on the JAMMA Connector. Check volume control setting. Check for +12VDC at pins F and 6 on the JAMMA connector, also -5VDC at pin 5. Check interboard wiring on CPU Board.

NO GENERAL ILLUMINATION

Check cabinet wiring for open connections to G.I. bulbs. Check G.I. fuse, if present.

PRESS START BUTTON AND NOTHING HAPPENS.

Check for open wires between the button and CPU Board. Check for contamination on CPU Board pins or the button switch blade contacts. Check for proper ground.

NO CREDIT GIVEN WHEN COINS ARE INSERTED.

Check for contamination on coin switch contacts. Check for an open wire between Coin Switch 1 and pin 16 on the JAMMA Connector or Coin Switch 2 and pin T of the JAMMA Connector.

TOO MANY CREDITS FOR NUMBER OF COINS INSERTED.

Check Game Pricing setting. Check for a Short between pins T and 16 on the JAMMA Connector.

GAME STAYS IN THE TEST MODE.

Check that the Test Switch in the coin door and the Test Switch (Position 1) on DIP Switch 2 are set to Off.

GAME OPERATES INTERMITTENTLY OR INCORRECTLY.

Check for proper Power Supply voltages:  
+5  $\pm$  0.25V  
+12  $\pm$  1.2V  
-5  $\pm$  0.25V

# NBA<sup>®</sup> HANGTIME<sup>™</sup> KIT

SECTION  
TWO



**Parts Information**

# A-20362 NBA HANGTIME CPU Assembly

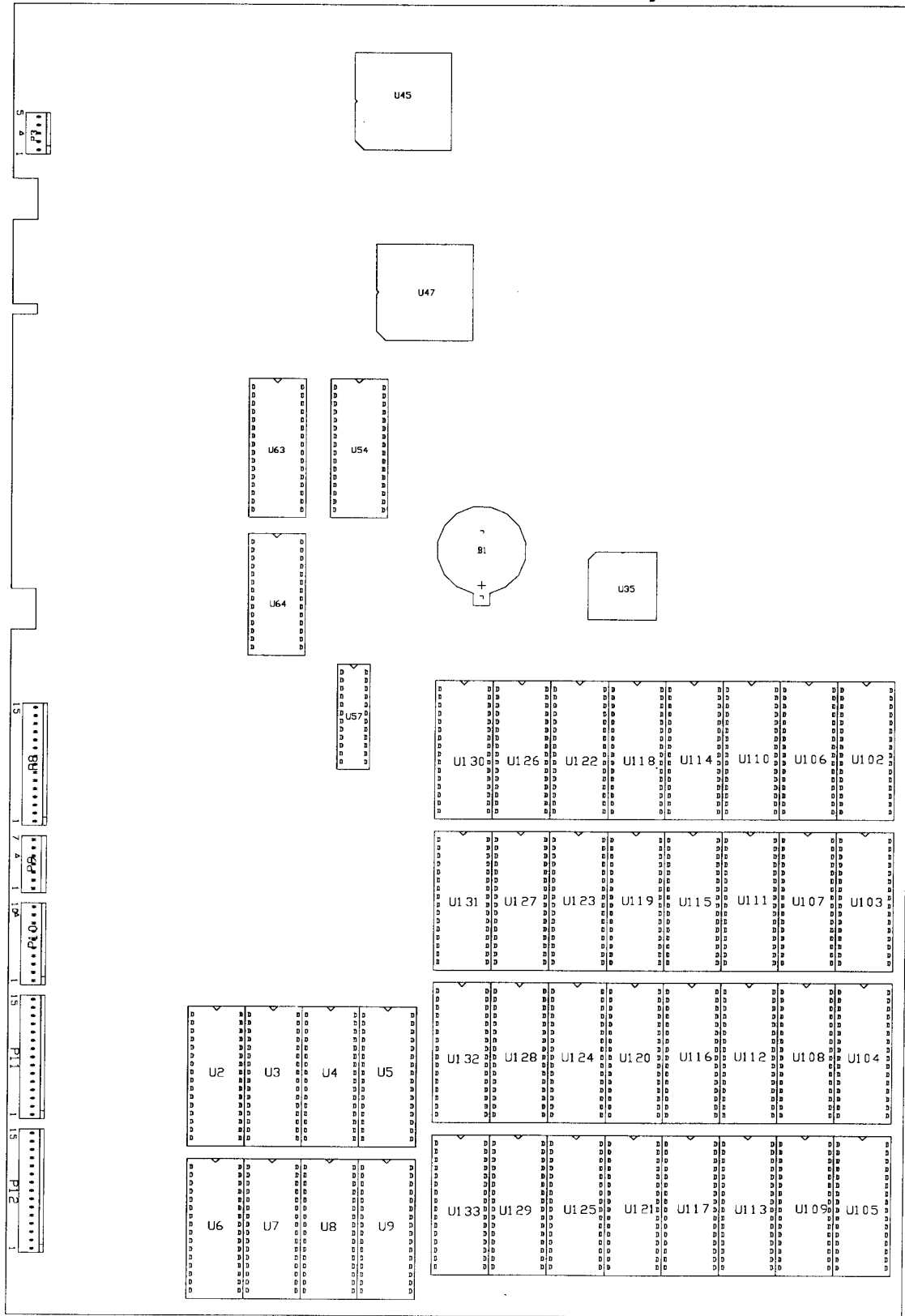

**A-20362**  
**NBA HANGTIME CPU Assembly**

PART NUMBER	DESCRIPTION	LOC	QTY
5880-11056-00	BATTERY 3V LITHIUM	B1	1
A-20255	SOUND PLD ASSY NHL	U57	1
A-20257	ASSY PLD 7032 44PJCC 15nS	U35	1
A-20258	ASSY PLD 7064 64PJCC 15nS	U45	1
A-20259	ASSY PLD 7064 64PJCC 15nS	U47	1
A-5343-40059-2	ASSY EPROM NBA MUSIC/SPCH	U2	1
A-5343-40059-3	ASSY EPROM NBA MUSIC/SPCH	U3	1
A-5343-40059-4	ASSY EPROM NBA MUSIC/SPCH	U4	1
A-5343-40059-5	ASSY EPROM NBA MUSIC/SPCH	U5	1
A-5343-40059-10	ASSY EPROM NBA GAME IMAGE	U122	1
A-5343-40059-11	ASSY EPROM NBA GAME IMAGE	U123	1
A-5343-40059-12	ASSY EPROM NBA GAME IMAGE	U124	1
A-5343-40059-13	ASSY EPROM NBA GAME IMAGE	U125	1
A-5343-40059-14	ASSY EPROM NBA GAME IMAGE	U126	1
A-5343-40059-15	ASSY EPROM NBA GAME IMAGE	U127	1
A-5343-40059-16	ASSY EPROM NBA GAME IMAGE	U128	1
A-5343-40059-17	ASSY EPROM NBA GAME IMAGE	U129	1
A-5343-40059-18	ASSY EPROM NBA GAME IMAGE	U130	1
A-5343-40059-19	ASSY EPROM NBA GAME IMAGE	U131	1
A-5343-40059-20	ASSY EPROM NBA GAME IMAGE	U132	1
A-5343-40059-21	ASSY EPROM NBA GAME IMAGE	U133	1
A-5343-40059-28	ASSY EPROM NBA GAME IMAGE	U121	1
A-5343-40059-29	ASSY EPROM NBA GAME IMAGE	U120	1
A-5343-40059-30	ASSY EPROM NBA GAME IMAGE	U119	1
A-5343-40059-31	ASSY EPROM NBA GAME IMAGE	U118	1
A-5343-40059-24	ASSY EPROM NBA GAME IMAGE	U113	1
A-5343-40059-25	ASSY EPROM NBA GAME IMAGE	U112	1
A-5343-40059-26	ASSY EPROM NBA GAME IMAGE	U111	1
A-5343-40059-27	ASSY EPROM NBA GAME IMAGE	U110	1
A-5343-40059-22	ASSY EPROM NBA PROGRAM	U54	1
A-5343-40059-23	ASSY EPROM NBA PROGRAM	U63	1

# PUSH BUTTON

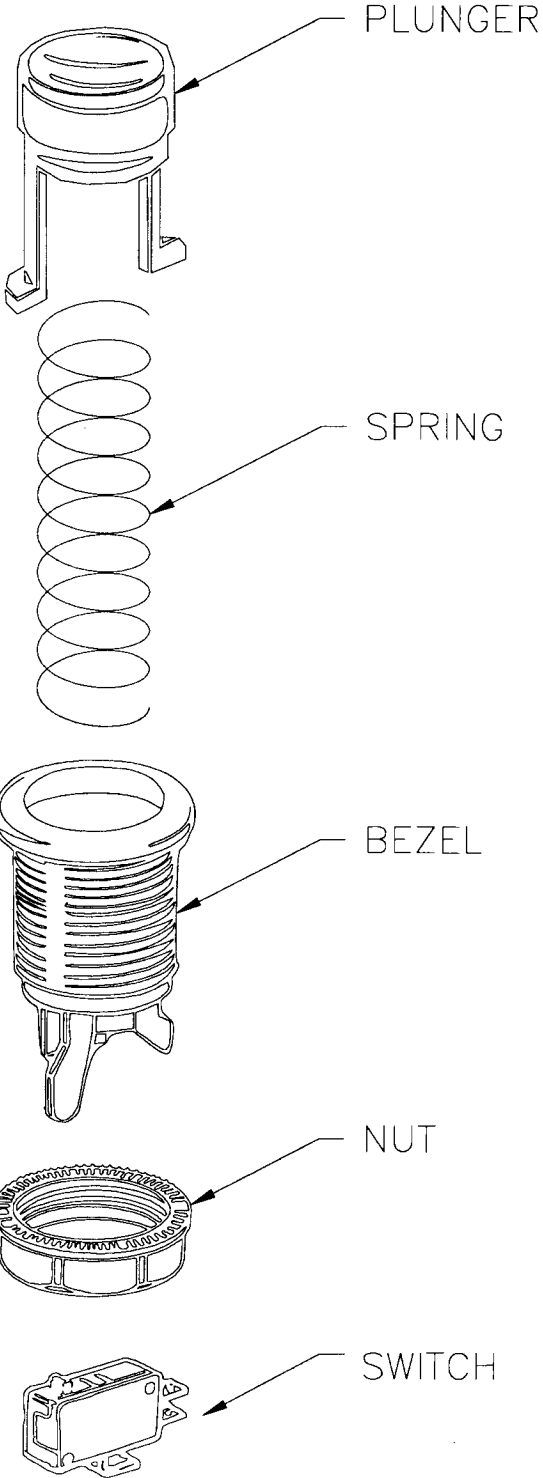

PART NUMBER / COLOR TABLE	
PART #	BUTTON COLOR
20-10209-1	RED
20-10209-3	WHITE
20-10209-3	BLUE
20-10209-7	ORANGE

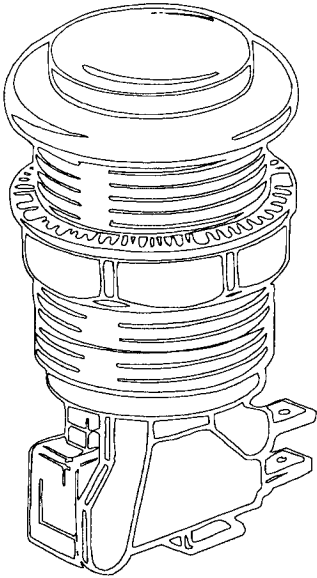

# JOYSTICK

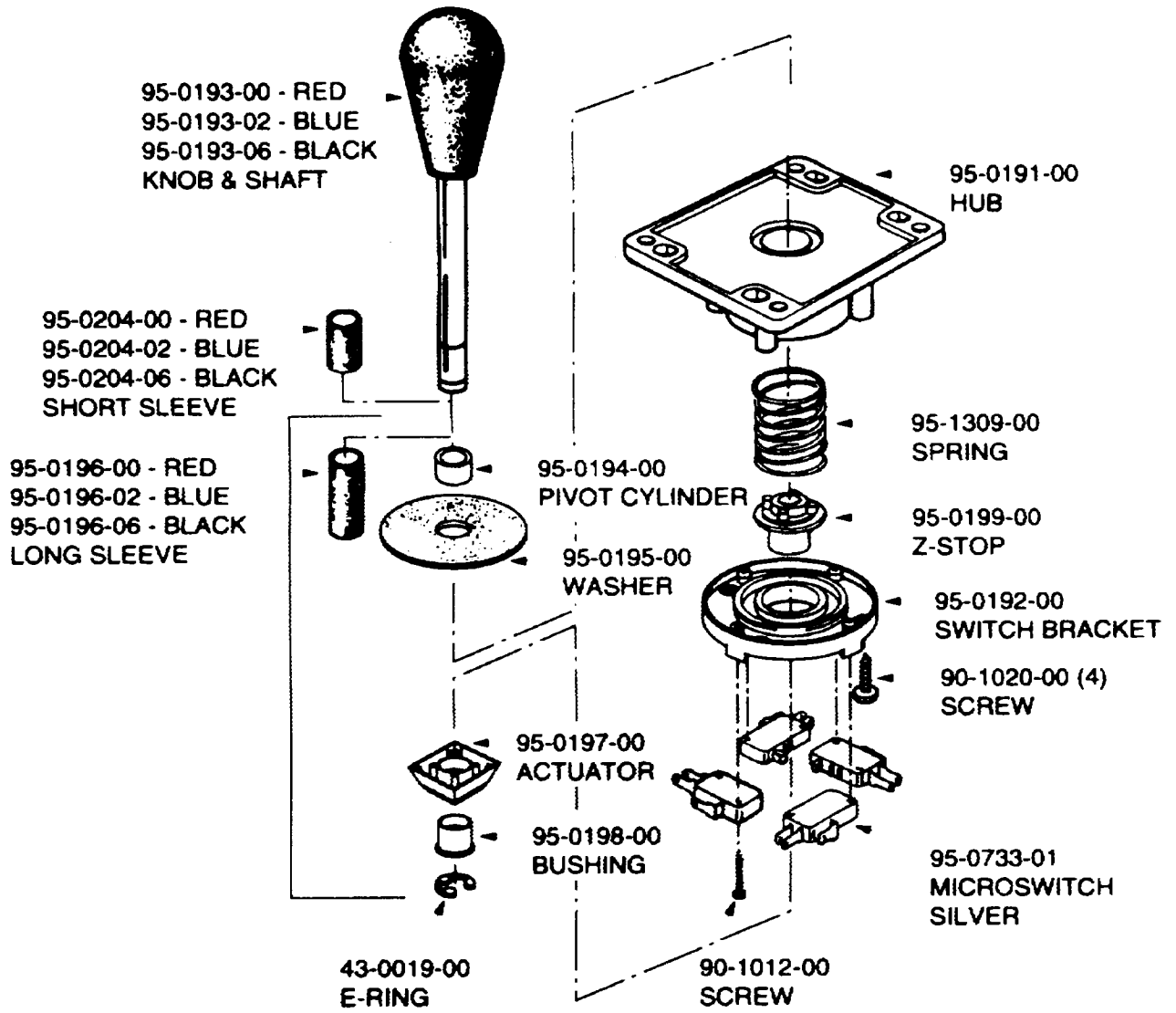



# NBA<sup>®</sup> HANGTIME<sup>™</sup> KIT

SECTION  
THREE



## Cabinet Wiring

PRINTED CIRCUIT BOARD ASSEMBLY SCHEMATICS ARE NO LONGER AVAILABLE.

## JAMMA CHART

Function	Wire Color	Pin	Pin	Wire Color	Function
Ground	Black	1	A	Black	Ground
Ground	Black	2	B	Black	Ground
+5 Volts DC	Red	3	C	Red	+5 Volts DC
+5 Volts DC	Red	4	D	Red	+5 Volts DC
-5 Volts DC	Yellow	5	E	Yellow	-5 Volts DC
+12 Volts DC	Orange	6	F	Orange	+12 Volts DC
	Key	7	H	Key	
Counter 1	Brown	8	J	Brown-Red	Counter 2
	NC	9	K	NC	
Speaker (+)	Red-Gray	10	L	Brown-Gray	Speaker (-)
	NC	11	M	NC	
Video Red	Yellow/Red	12	N	Yellow/Green	Video Green
Video Blue	Yellow/Blue	13	P	Yellow/White	Video Sync
Video Ground	Yellow/Black	14	R	White-Gray	Service Credit
Test	Black-Blue	15	S	Black-Green	Slam Tilt
1 Coin	Black-Brown	16	T	Black-Red	2 Coin
1 Start	White	17	U	Violet-White	2 Start
1 Up	White-Black	18	V	Violet-Black	2 Up
1 Down	White-Brown	19	W	Violet-Brown	2 Down
1 Left	White-Red	20	X	Violet-Red	2 Left
1 Right	White-Orange	21	Y	Violet-Orange	2 Right
1 Shoot/Block	White-Yellow	22	Z	Violet-Yellow	2 Shoot/Block
1 Pass/Steal	White-Green	23	a	Violet-Green	2 Pass/Steal
1 Turbo	White-Blue	24	b	Violet-Blue	2 Turbo
Not Used	White-Violet	25	c	Violet	Not Used
	NC	26	d	NC	
	NC	27	e	NC	NC
Ground	Black	28	f	Black	Ground

# CABINET WIRING DIAGRAM

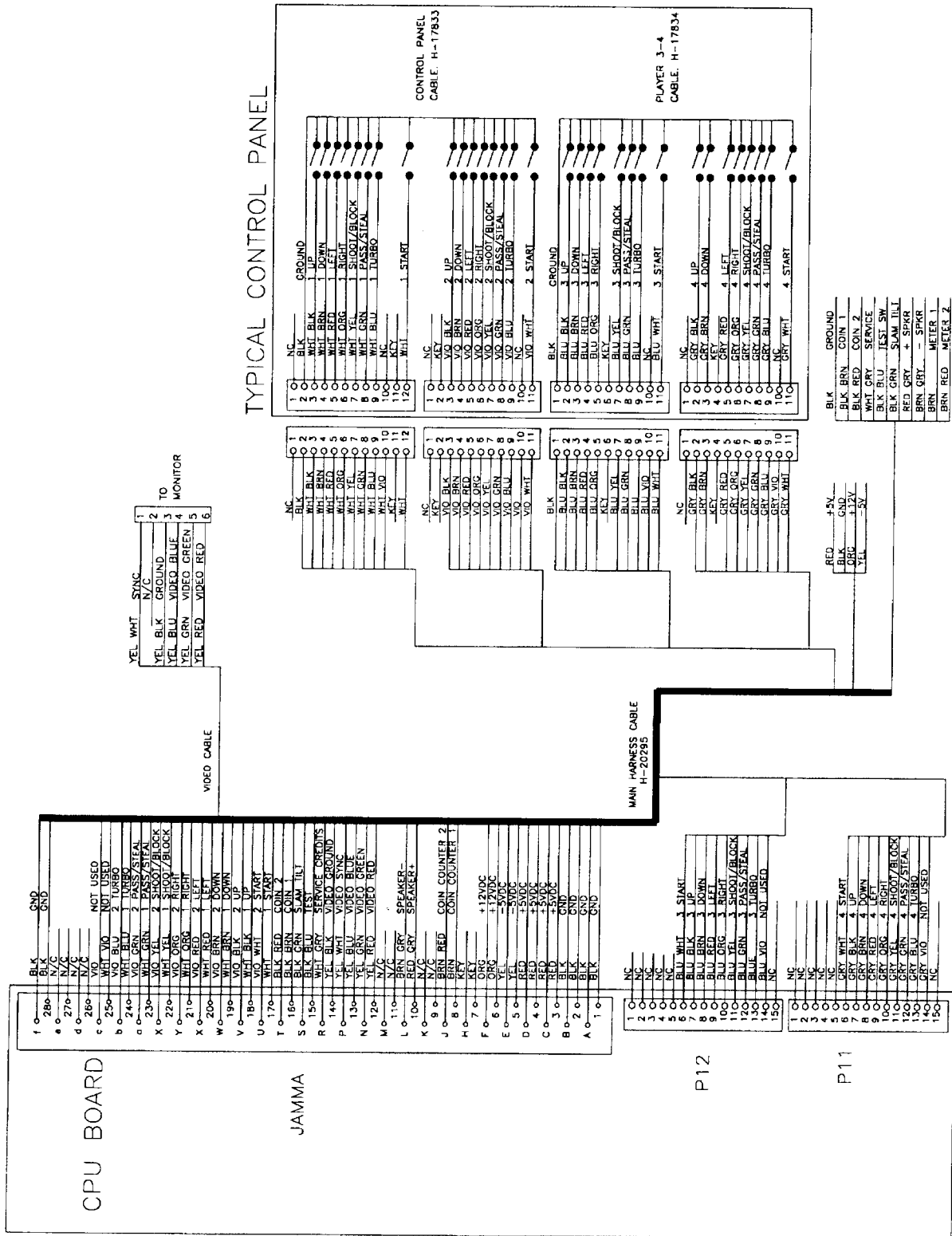

# COIN SWITCH AND METER WIRING

## OPTION 1

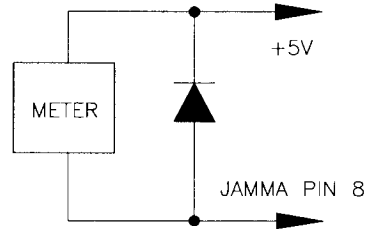
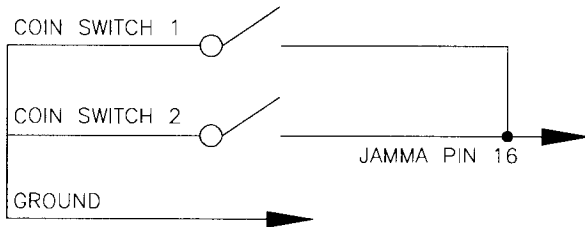

## OPTION 2

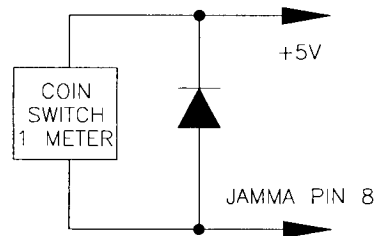
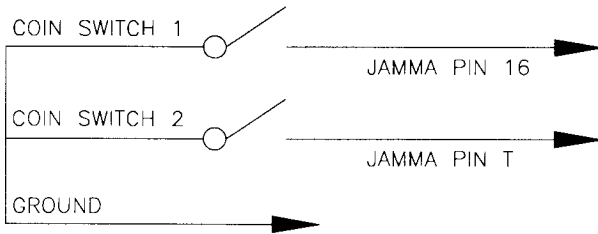

### **!!WRONG WAY!!**

**Do not connect the coin switches in this manner. This circuit is INCORRECT, and will cause twice as many credits per coin.**

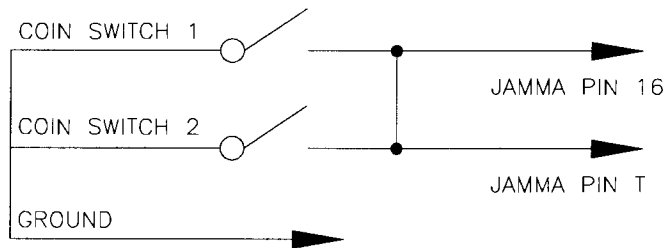

# CONTROL PANEL TEMPLATE PLAYER 1

HOLE LEGEND	
SIZE	HOLE
1.19 DIA. HOLE THRU	A
1.25" HOLE THRU, C'BORE 3.00" X .090 DEEP (+.031, -0.00) ON NEAR SIDE	B
.22" HOLE THRU, .75" C'BORE X .063" DEEP	C

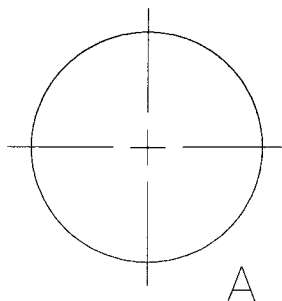
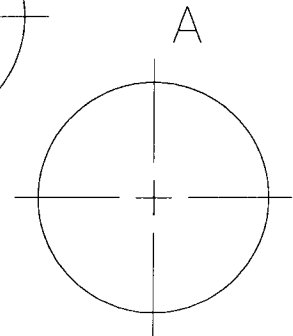
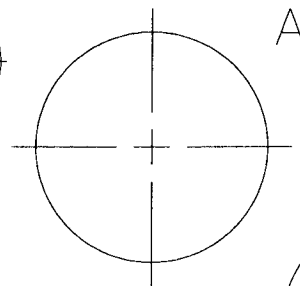
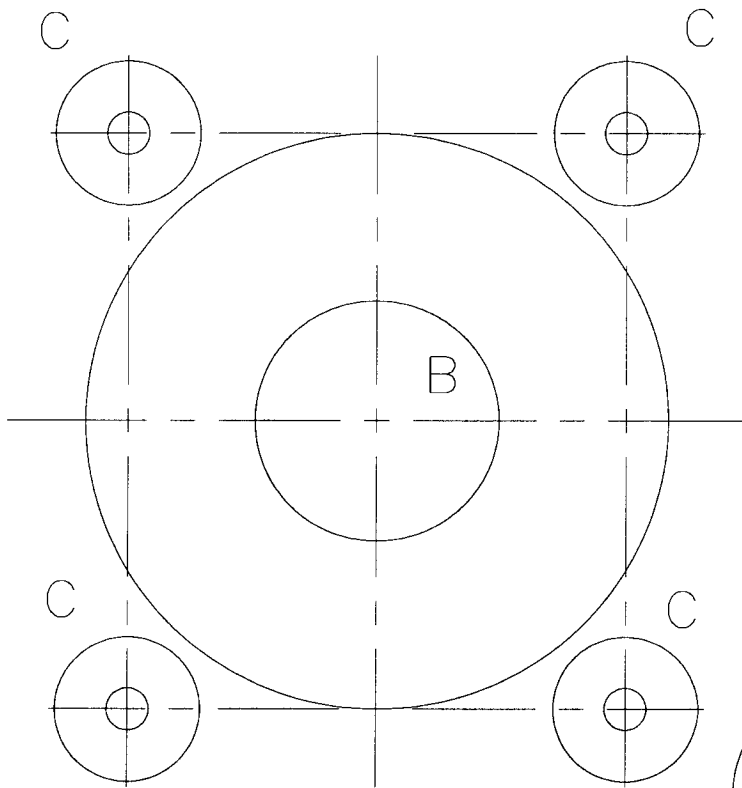
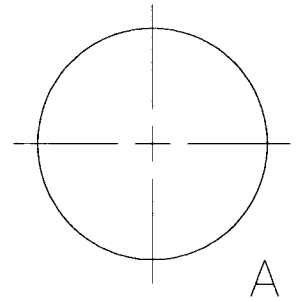

# CONTROL PANEL TEMPLATE PLAYER 2

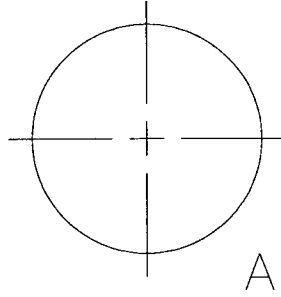

HOLE LEGEND	
SIZE	HOLE
1.19 DIA. HOLE THRU	A
1.25" HOLE THRU, C'BORE 3.00" X .090 DEEP (+.031, -0.00) ON NEAR SIDE	B
.22" HOLE THRU, .75" C'BORE X .063" DEEP	C

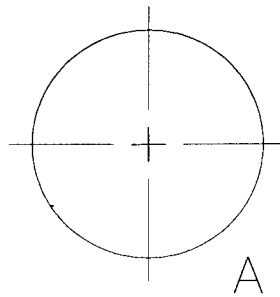
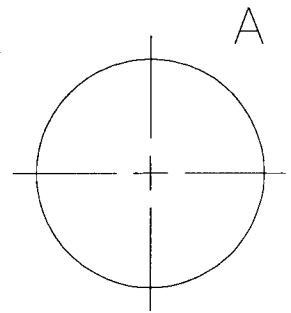
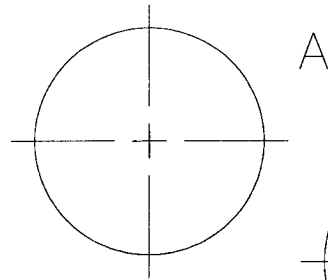
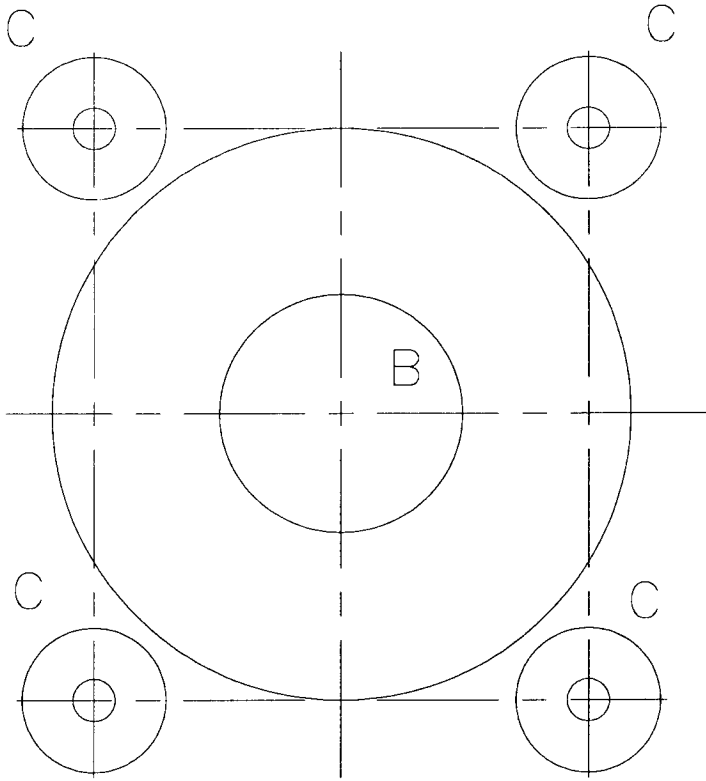

**CONTROL PANEL TEMPLATE  
PLAYER 3**

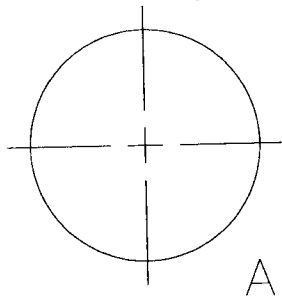

HOLE LEGEND	
SIZE	HOLE
1.19 DIA. HOLE THRU	A
1.25" HOLE THRU, C'BORE 3.00" X .090 DEEP (+.031, -0.00) ON NEAR SIDE	B
.22" HOLE THRU, .75" C'BORE X .063" DEEP	C

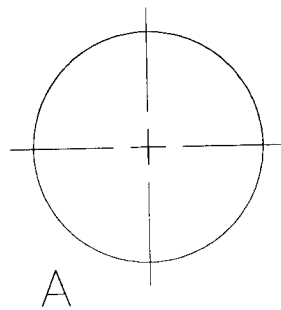
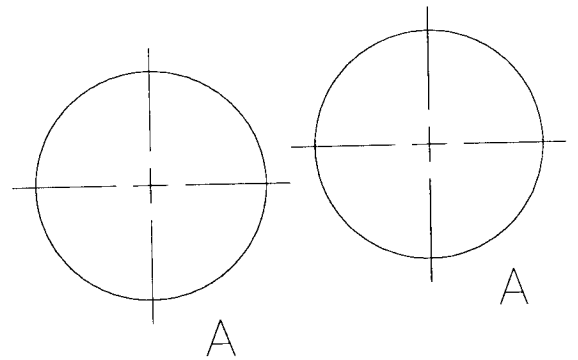
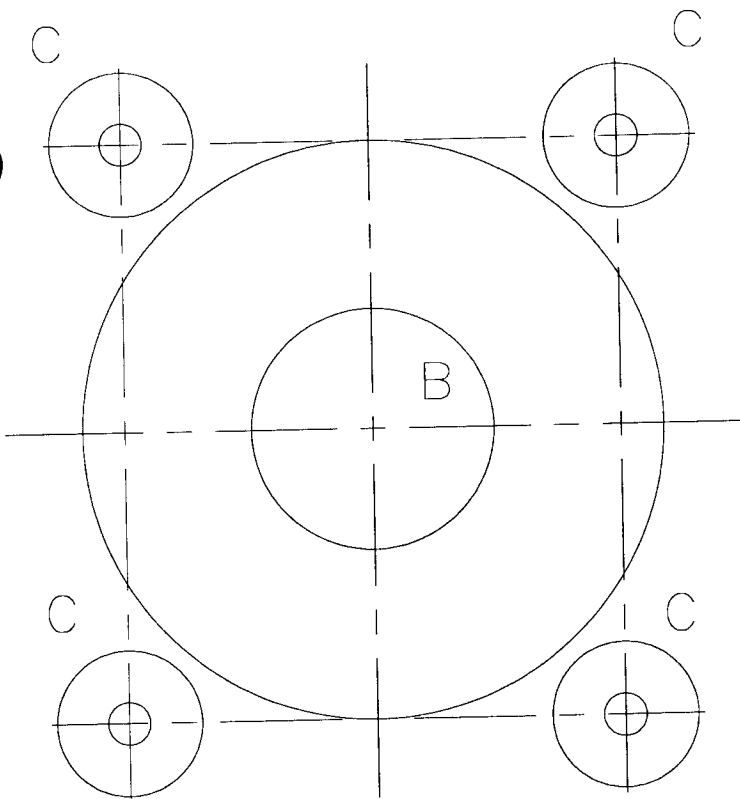

# CONTROL PANEL TEMPLATE PLAYER 4

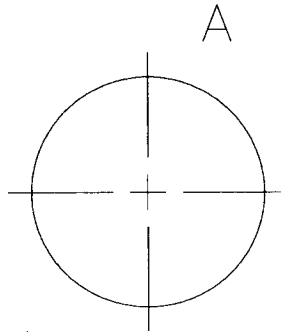
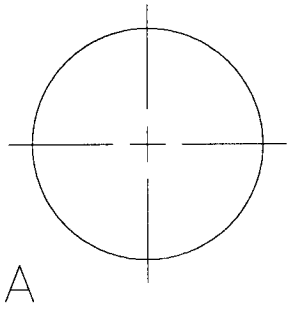

HOLE LEGEND	
SIZE	HOLE
1.19 DIA. HOLE THRU	A
1.25" HOLE THRU, C'BORE 3.00" X .090 DEEP (+.031, -0.00) ON NEAR SIDE	B
.22" HOLE THRU, .75" C'BORE X .063" DEEP	C

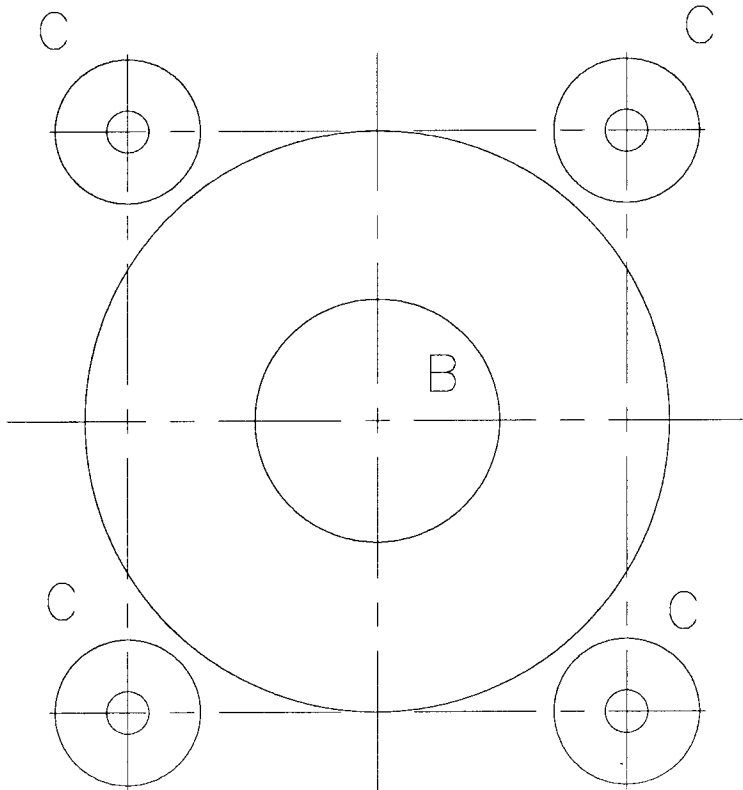
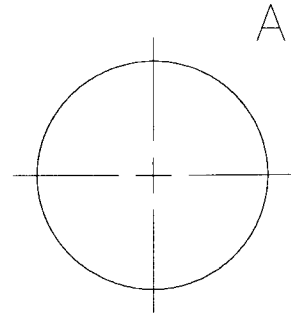
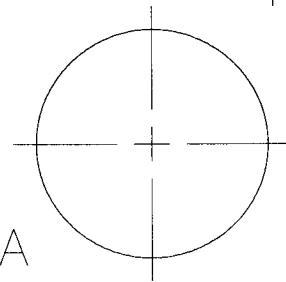



## WARNINGS & NOTICES

### Warning

USE OF NON-MIDWAY PARTS OR CIRCUIT MODIFICATIONS MAY CAUSE SERIOUS INJURY OR EQUIPMENT DAMAGE! USE ONLY MIDWAY AUTHORIZED PARTS.

\* For safety and reliability, substitute parts and modifications are not recommended.

\* Substitute parts or modifications may void FCC type acceptance.

\* This game is protected by federal copyright, trademark and patent laws. Unauthorized modifications may be illegal under federal law. This also applies to MIDWAY logos, designs, publications and assemblies. Moreover, facsimiles of MIDWAY equipment (or any feature thereof) may be illegal under federal law, regardless of whether or not such facsimiles are manufactured with MIDWAY components.

### Warning

**NOTE:** This equipment generates, uses and can emit radio frequency energy and, if not installed properly and used according to the directions in this manual, may cause interference to radio communications. It has been tested and found to comply with the limits for a Class A computing device pursuant to Subpart J of part 15 of FCC rules which are designed to provide reasonable protection against such interference when operated in a commercial environment. Operation of this equipment in a residential area is likely to cause interference to radio communications, in which the user, at his or her own expense, will be required to take whatever measures may be needed to correct the interference.

### Warning

Prevent shock hazard and assure proper game operation. Only plug this game into a properly grounded outlet. Do not use a cheater plug to defeat the power cord's grounding pin. Do not cut off the ground pin.

### NOTICE - FCC COMPLIANCE STICKER

- I. THIS KIT WAS TESTED IN A MIDWAY UNIVERSAL VIDEO CABINET (MODEL 40135) AND FOUND TO COMPLY WITH FCC PART 15 CLASS A REQUIREMENTS. IF INSTALLED IN A MIDWAY UNIVERSAL VIDEO CABINET (MODEL 40135), THE FCC COMPLIANCE STICKER (16-9306) SUPPLIED IS TO BE PLACED ON THE REAR OF THE CABINET.
- II. INSTALLATION OF THIS KIT INTO ANY OTHER PRODUCT DOES NOT GUARANTEE COMPLIANCE WITH FCC REQUIREMENTS. YOU ARE SOLELY RESPONSIBLE, AND MIDWAY WILL HAVE NO RESPONSIBILITY FOR FCC COMPLIANCE FOR INSTALLATIONS IN OTHER PRODUCTS. THE FCC COMPLIANCE STICKER SUPPLIED SHOULD NOT BE INSTALLED ON THE CONVERTED PRODUCT UNTIL FCC COMPLIANCE IS VERIFIED.

### Notice

No part of this publication may be reproduced by any mechanical, photographic, or electronic process, or in the form of a phonographic recording, nor may be transmitted, or otherwise copied for public or private use, without permission from the publisher.

**For Service: Call your Authorized MIDWAY Distributor.**

©1996 Midway® Manufacturing Company.  
All rights reserved.

The NBA® and individual NBA® Team identifications used on or in this product are trademarks, copyrighted designs and other forms of intellectual property of NBA® Properties, Inc. and the respective Teams and may not be used, in whole or in part, without the prior written consent of NBA® Properties, Inc. © NBA® Properties, Inc. All rights reserved.

**MIDWAY MANUFACTURING COMPANY  
3401 N. CALIFORNIA AVE.  
CHICAGO, ILLINOIS 60618**

Entire contents of this manual copyright © 1995 MIDWAY Manufacturing Company. All rights reserved.