

namco[®]



TEKKEN 5

Game PCB Kit

Connections
and
Adjustments

NOTICE

MAGICGATE is a term to describe a copyright protection technology created by Sony Group. This **MAGICGATE** mark does not necessarily guarantee compatibility with other products bearing the “MagicGate” trademark.

MAGICGATE is a trademark of Sony Corporation.

MAGICGATE est un terme décrivant une technique de protection de copyright créée par Sony Group. **MAGICGATE** ne garantit pas nécessairement de compatibilité avec d'autres produits portant la marque de commerce “MagicGate”

MAGICGATE est une marque de commerce de Sony Corporation.

The DVD-ROM DISC supplied with the product must not be copied, modified, distributed, or used for the purposes other than the operation of the product. Copyright laws protect the contents of the DVD-ROM DISC. Infringement of copyright laws may be subject to criminal penalties.

Do not use the supplied DVD-ROM DISC with other product models or other media formats. Doing so may result in equipment failure.

Contents

KIT CONTENTS	5
1. SPECIFICATIONS	7
2. CABINET CONNECTIONS (Standard Jamma)	7
3. CABINET CONNECTIONS (JVS Standard)	11
4. FITTING THE DONGLE	12
5. FITTING THE CD-ROM	13
6. ADJUSTMENTS AND SETTINGS	14
6-1 Option Switches	14
6-2 Test Mode	15
6-2-1 Display Test	17
6-2-2 Colour Edit	17
6-2-3 Convergence	17
6-2-4 Input Test	18
6-2-5 Game Options	19
6-2-6 Coin Options	21
6-2-7 Sound Test	22
6-2-8 JVS Status	22
6-2-9 Bookkeeping	23
6-2-10 Data Clear	25
6-2-11 Card Options (Where Fitted)	26
6-2-12 Close Setting (When Card Reader Fitted)	29

KIT CONTENTS

Description	Part No	Quantity
Tekken 5 PCB Rack Assy	XTEK5-RACKASSY	1
DVD Rom CD Disc	XTEK5-DVD	1
Jamma (B) PCB	XTEK4-JAMMA	1
Tekken 5 Security Dongle	XTEK5-DONGLE	1
Rack Assy to Jamma (B) PCB connecting cables	Power Supply Loom	1
	RGB Video Loom	1
	RCA (Phono) Audio Loom	1
	Data Loom	1
	Amp EI with Flying Leads	69200067
Extender PCB	470000574	1
Amp EI connectors with Flying Leads Loom	69200066	1
Button Decals	40000785	1 set
Instruction Card	40000783	1
Move List Card	40000784	1
Tekken 5 Promotional Poster		1
Top Flash	40000703	1
Universal Cabinet Side Decal - LHS / RHS	40000704	2
Header Decal	40000782	1
Connection and Adjustment Manual	90500153	1

Card Read/Write Parts (Where Applicable)

Read/Write Assembly	XTEK5-CARDRWASSY	2
S-CONV PCB	XTEK5-SCONVPCB	2
EXCARD PCB	XTEK5-EXCARDPCB	1
EXCARD PCB to S-CONV PCB Loom	69200134	1
Read/Write Surround Decal - Player 1	40000817	1
Read/Write Surround Decal - Player 2	40000818	1
Card Decal	40000792	1
Card Read/Write Decal	40000793	1

1. SPECIFICATIONS

COMPATIBILITY: JAMMA STANDARD (with JAMMA (B) PCB)
JAMMA VIDEO STANDARD (JVS)

PCB INPUT POWER: +5v ($\pm 5\%$) @ 7A (Min), +12v ($\pm 5\%$) @ 2A (Min)

OPERATING ENVIRONMENT: Temperature +5°C to +45°C
Humidity 10% to 85% (no condensation)

MONITOR ORIENTATION AND SIGNAL: Horizontal Orientation
Horizontal Frequency 15kHz / 31kHz (selectable)

RGB output level 0.7V p-p / 3.0V p-p (selectable)
when set to 15kHz
0.7V p-p when set to 31kHz

Composite Sync / Separate Sync (selectable)

2 CABINET CONNECTIONS (Standard Jamma)

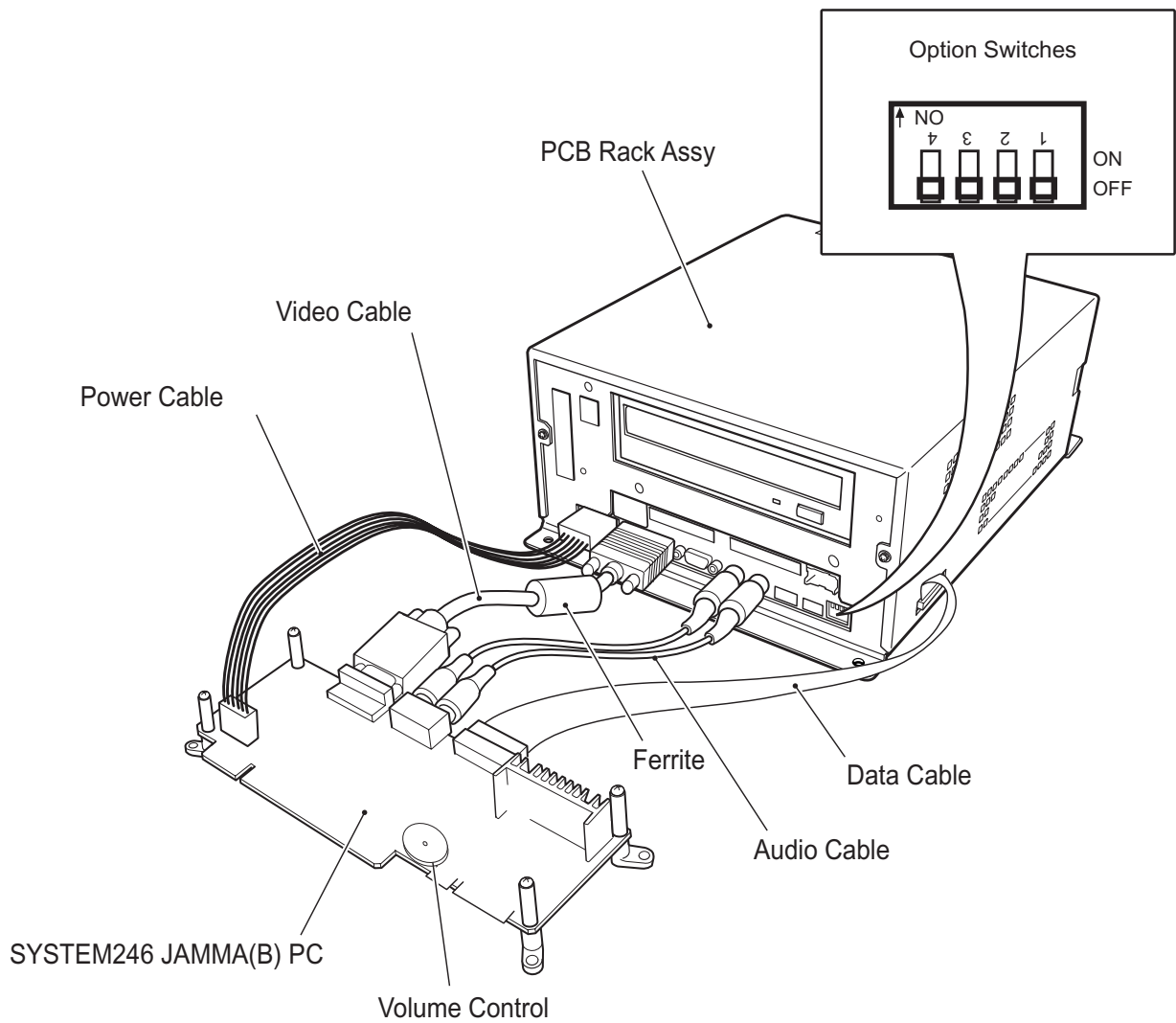

The JAMMA (B) PCB is connected to the game cabinet with a 56way Edge Connector (standard JAMMA) and 4 and 10way AMP EI Connectors.

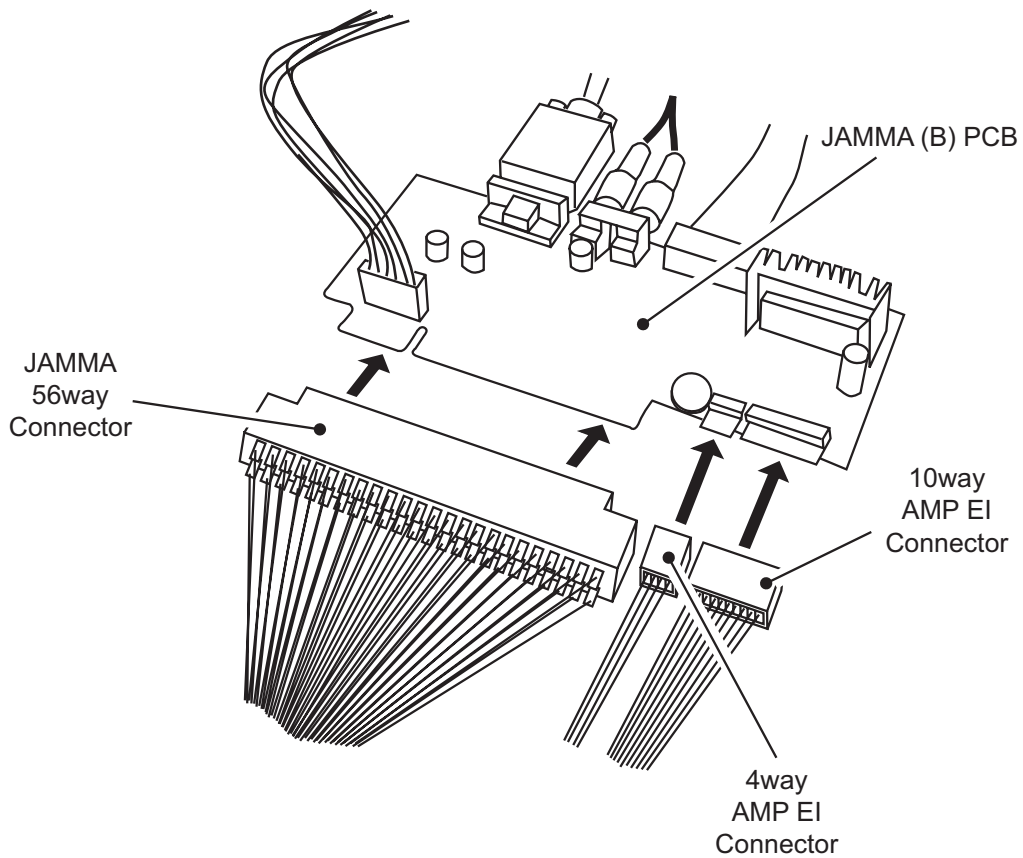

Note: Supplied in the Kit is an Amp EI connectors to 48way extender card adaptor loom, for cabinets with an existing 48way connector, and an AMP EI connectors with flying leads loom for cabinets without a 48way connection.



4 and 10way AMP EI Connector with 48way Extender Card
Part No. 69200067



4 and 10way AMP EI Connector with flying leads
Part No.69200066

Connections for Standard JAMMA Cabinet

TEKKEN 5			
Jamma 56way Edge Connector			
Solder Side	Terminal No		Component Side
GND	A	1	GND
GND	B	2	GND
+5 volt	C	3	+5 volt
+5 volt	D	4	+5 volt
	E	5	
+12 volt	F	6	+12 volt
Polarizing Key	H	7	Polarizing Key
Coin Counter 2	J	8	Coin Counter 1
	K	9	
L Speaker (-)	L	10	L Speaker (+)
Audio (-) (mono)	M	11	Audio (+) (mono)
Video GREEN	N	12	Video RED
Video SYNC	P	13	Video BLUE
Service Switch	R	14	Video GND
	S	15	Test Switch
Coin Switch 2	T	16	Coin Switch 1
P2 Start Switch	U	17	P1 Start Switch
P2 Lever UP	V	18	P1 Lever UP
P2 Lever DOWN	W	19	P1 Lever DOWN
P2 Lever LEFT	X	20	P1 Lever LEFT
P2 Lever RIGHT	Y	21	P1 Lever RIGHT
P2 Punch (Left) Sw 1	Z	22	P1 Punch (Left) Sw 1
P2 Punch (Right) Sw 2	a	23	P1 Punch (Right) Sw 2
	b	24	
	c	25	
	d	26	
GND	e	27	GND
GND	f	28	GND

Connector Loom (Part No. 69200066)	
TEKKEN 5	
10way AMP EI Connector	
Pin No.	Description
1	GND
2	
3	P2 Kick (Right) Sw 5
4	P2 Kick (Left) Sw 4
5	
6	
7	P1 Kick (Right) Sw 5
8	P1 Kick (Left) Sw 4
9	
10	GND

TEKKEN 5	
4way AMP EI Connector	
Pin No.	Description
1	
2	
3	R Speaker (+)
4	R Speaker (-)

PREVIOUS TEKKEN GAMES					
48way Extension Connector					
Solder Side		Terminal No.		Component Side	
4w AMP EI pin 4	R Speaker (-)	A24	B24	R Speaker (+)	
		A23	B23		
		A22	B22		
		A21	B21		
	Polarizing Key	A20	B20	Polarizing Key	
		A19	B19		
		A18	B18		
10way AMP EI pin 4	P2 KICK (Left)	A17	B17	P2 KICK (Right)	
		A16	B16		
		A15	B15	GND	
		A14	B14	GND	
		A13	B13		
		A12	B12		
		A11	B11		
		A10	B10		
		A9	B9		
		A8	B8	GND	
	A7	B7	GND		
	A6	B6	P1 KICK (Right)		
10way AMP EI Pin 8	P1 KICK (Left)	A5	B5		
		A4	B4		
		A3	B3		
		A2	B2		
		A1	B1		

4way AMP EI pin 3

10way AMP EI pin3

10way AMP EI Pin 10

10way AMP EI Pin 10

10way AMP EI Pin 1

10way AMP EI Pin 1

10way AMP EI Pin 7

3. CABINET CONNECTIONS (JVS Standard)

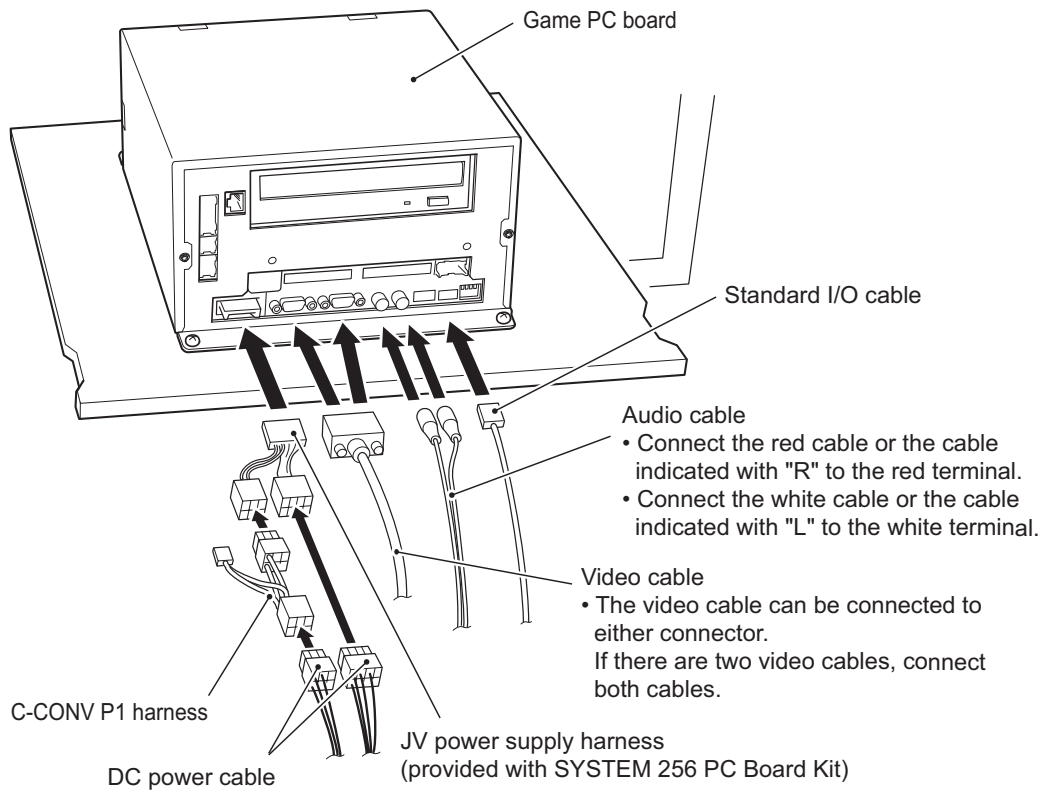

4. FITTING THE DONGLE

The dongle included in this kit is limited to this game only. DO NOT insert this Dongle in other games. Inserting the Dongle in other games may cause damage.

Ensure that the power is switched OFF before inserting the Dongle.

Insert the dongle (with a bar code label) into the dongle insertion slot (on the left side), making sure that the bar code label side is facing up. Insert it firmly until the dongle is held firmly by the connector inside the slot.

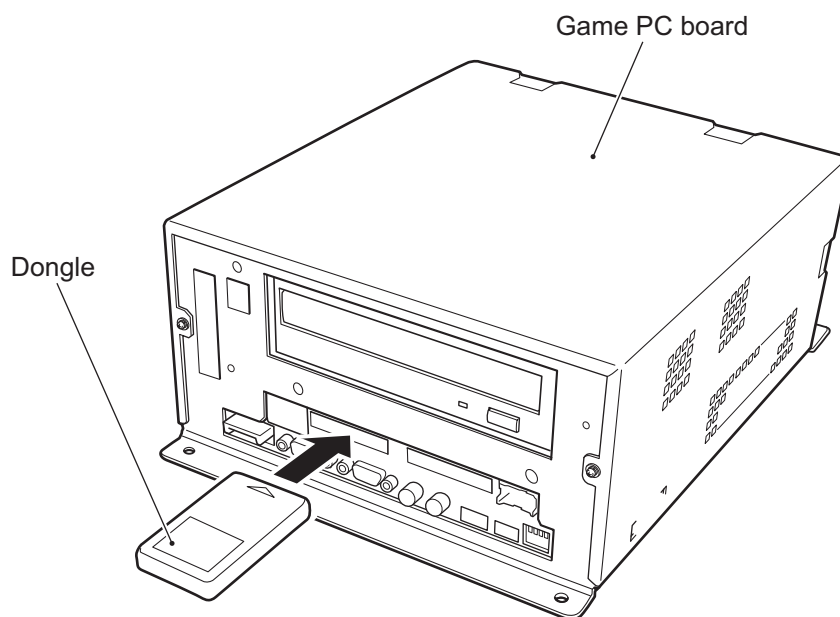

5. FITTING THE CD-ROM

- The DVD-ROM Disc must be inserted with the power switched on. To prevent an electric shock, accident or injury, do not touch any parts other than those specified below.
 - The supplied DVD-ROM Disc is designed exclusively for this product. Never use the DVD-ROM Disc in any other product. Do not insert other DVD-ROM Discs in the DVD-ROM drive of this game.
 - The DVD-ROM tray retracts automatically after 10 seconds.
1. Press the eject button of the CD-ROM drive to open the tray.

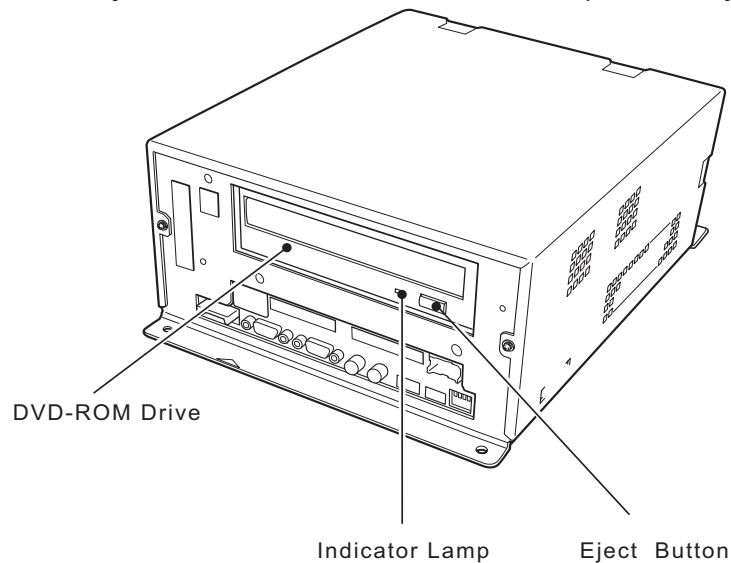

2. Place the DVD-ROM Disc on to the tray, ensuring that the label side (printed surface) is facing away from the Tray.

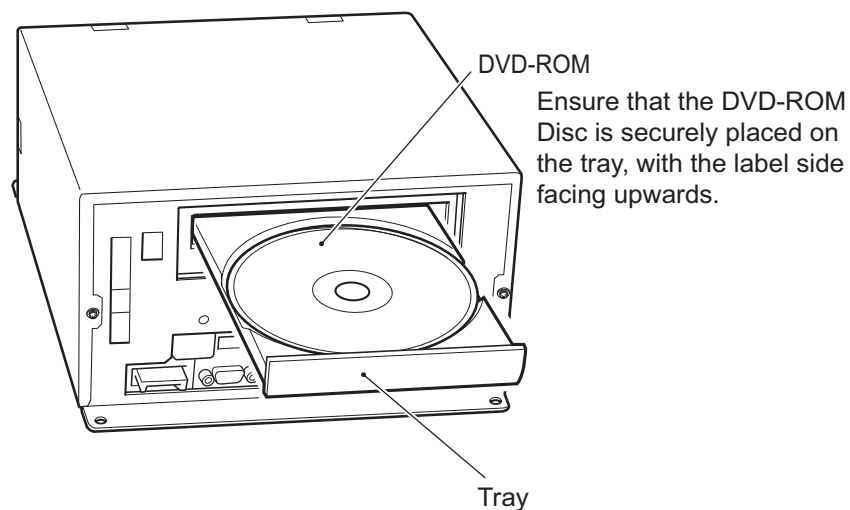

3. Press the Eject button to retract the Tray in to the unit.
4. Switch the power OFF, wait approx 10 seconds then switch the game back ON.

6. ADJUSTMENTS AND SETTINGS

The Game PC Board Assy is fitted with 4 Option Switches.

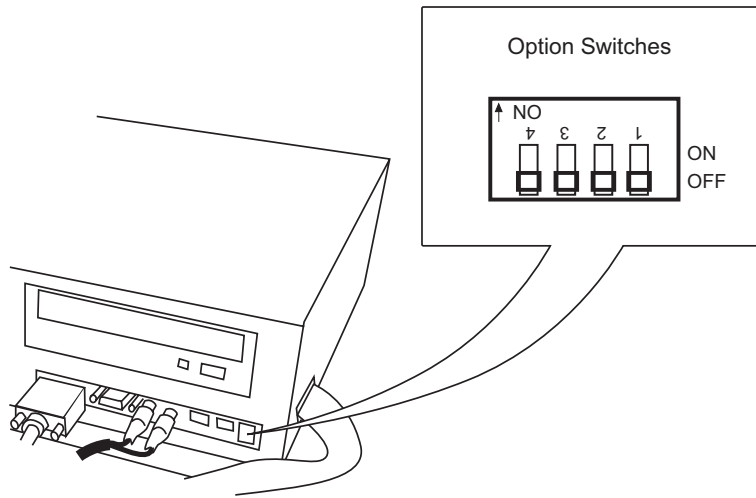

The JAMMA (B) PCB has the Volume Control fitted.

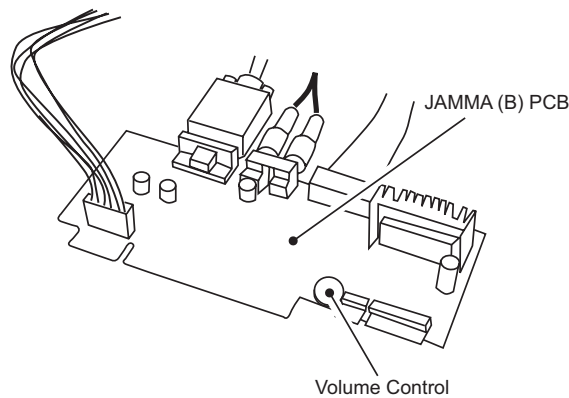

6-1 Option Switches

Switch 1 is used to change between Test Mode and Game Mode.

ON: Test Mode OFF: Game Mode

Switch 2 is used to set the output level of the video signal.

31kHz ON: 0.7V p-p OFF: 0.7V p-p

15kHz ON: 3.0V p-p OFF: 0.7v P-P

Switch 3 is used to change the monitor Sync Frequency

ON: 31kHz OFF: 15kHz

Note: When using a 31kHz monitor, set the RGB input of the monitor to 0.7v. If the monitor does not have a setting adjustment, refer to page 17 section 6-2-1 "Display Test", and change the Contrast and RGB Brightness levels to adjust the brightness.

Switch 4 is used to set the Video Sync Signal

ON: Composite Sync OFF: Seperate Sync

6-2 Test Mode

To enter Test Mode set the Test switch in the cabinet (if fitted) to ON, or if no Test switch is fitted to the cabinet, set Option switch 1 ON

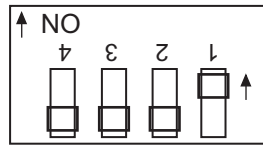

Note: The test mode is activated only when the cabinet Test switch or Option switch 1 is moved from OFF to ON. If the game is switched on with either switch in the ON position the Test Mode will not be activated. The switch must be switched OFF and then ON to enter the test mode.

When the Test Mode is entered, the following screen is displayed.

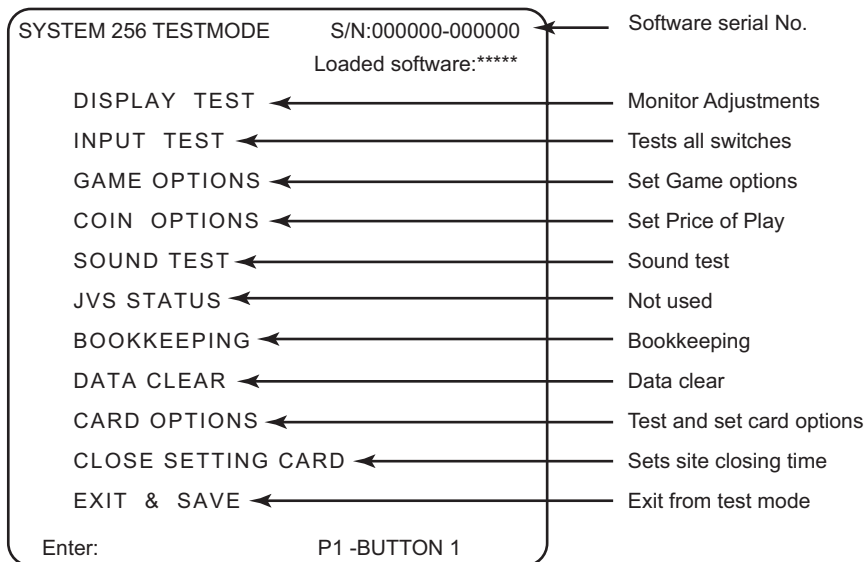

Use the Joystick Up or Down to step through the tests. (The selected test will be displayed in red)

Press the 1 Player Button 1 to enter the selected test.

After making adjustments select EXIT and press the 1 Player Button 1 to return to the above screen. Select another test or select 'EXIT & SAVE' and press the 1 Player Button 1 to save the changes and return to the Game Mode.

Note: If 'EXIT & SAVE' is not selected and activated, any changes made may not be stored properly. Switching the cabinet Test switch or Option 1 switch OFF does not exit the Test Mode.

Switch the cabinet Test switch or Option 1 switch OFF.

6-2-1 Display Test

This test allows the following checks and adjustments to be made.

- **Colour Edit**
Adjust contrast and brightness of each colour to match video output from the PCB to the Monitor.
Note: This adjustment should only be made if the correct picture quality cannot be achieved by using the normal monitor adjustments.
 - **Convergence**
Check and adjust the size, position and distortion of the screen image.
1. Select display Test from the Test Menu Screen, the following screen is displayed.

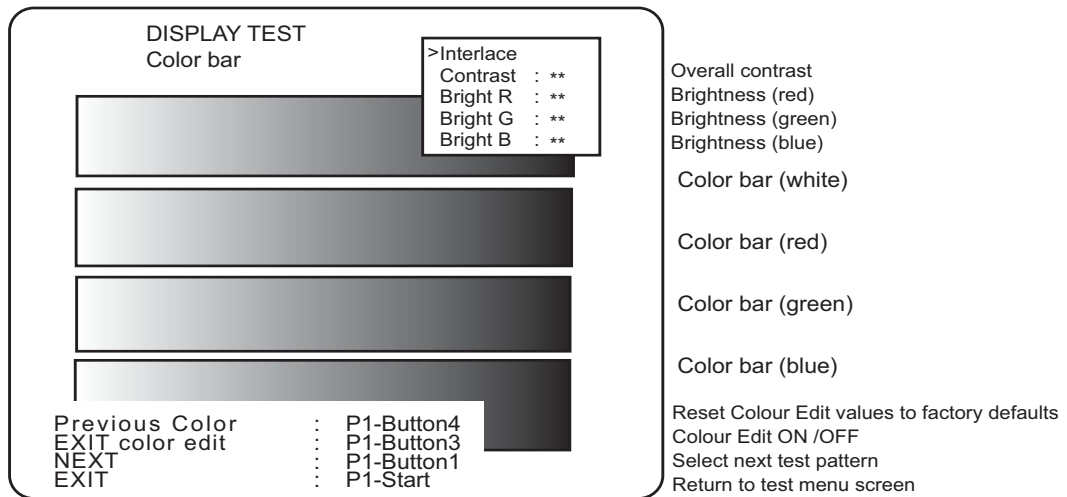

2. Each time the 1P Button 3 is pressed the Colour Edit adjustment box is turned ON or OFF.

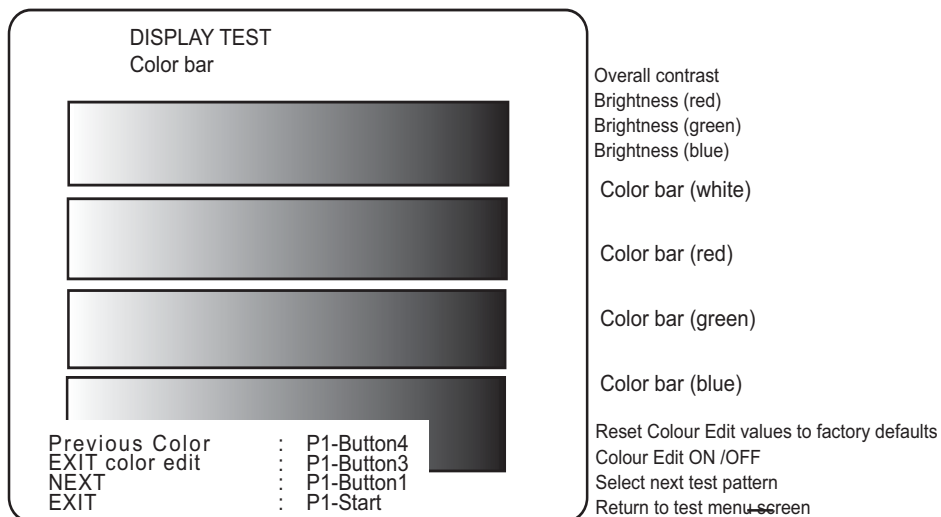

3. Press the 1P Button 1 to step to the next test function

COLOUR BAR → CONVERGENCE

6-2-2 Colour Edit

1. Ensure that the Colour Edit Adjustment Box is showing. (Press P1 Button 3 if the Adjustment box is not displayed).
2. Use the Joystick UP/DOWN to step to the required adjustment. (Contrast, Brightness (red), Brightness (green), Brightness (blue)).
3. Use the Joystick LEFT/RIGHT to adjust the value.
3. When all adjustments have been made, press P1 Button 1 to step to the Convergence Test or P1 Start Button to return to the Main Test Menu screen

6-2-3 Convergence

Use this screen to adjust the geometry (height, width , etc.) of the Monitor.

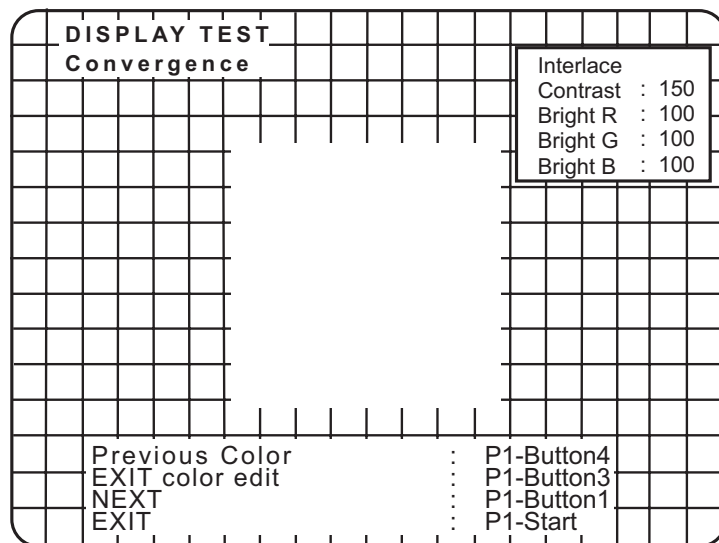

The screen colour will change each time P1 Button 4 is pressed. When all adjustments have been made, press P1 Button 1 to return to the Colour Bar Screen or P1 Start Button to return to the Main Test Menu screen.

6-2-4 Input Test

Select Input Test from the Main Test Menu. The following screen is displayed.

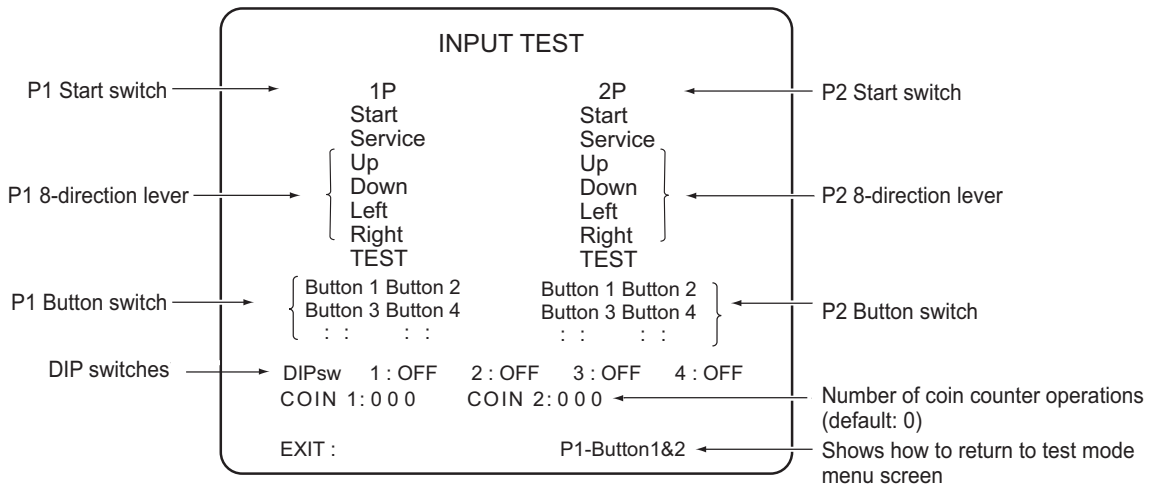

Each time a switch is operated, the corresponding item on the display will change colour to red, except the DIP switches which show whether the switch is ON or OFF.

When testing is completed, press P1 Buttons 1 and 2 together to return to the Main Test Menu screen.

6-2-5 Game Options

1. Select Game Options from the Main Test Menu. The following screen is displayed.

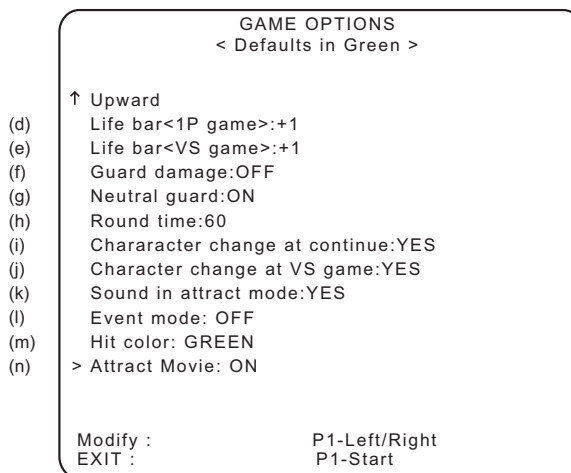
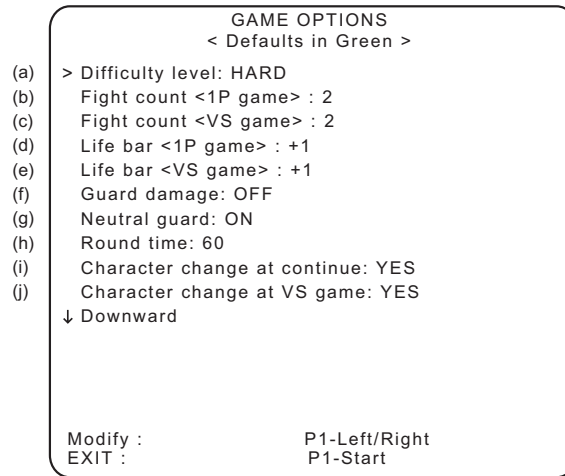

2. Use the Joystick UP/DOWN to step to the required adjustment.
3. Use the Joystick LEFT/RIGHT to adjust the value.
4. When all adjustments have been made, press P1 Start Button to return to the Main Test Menu screen

(a) Difficulty level (degree of game difficulty)

EASY	MEDIUM	HARD	VERY HARD	ULTRA HARD
------	--------	------	-----------	------------

(b) Fight Count <1P game > (number of rounds required to win the game in 1 player mode)

1	2	3	4	5
---	---	---	---	---

(c) Fight Count <VS game > (number of rounds required to win the game in 2 player mode)

1	2	3	4	5
---	---	---	---	---

(d) Life bar <1P game > (energy guage in 1 player mode)

-2	-1	NORMAL	+1	+2
----	----	--------	----	----

(e) Life bar < VZ game > (energy guage in 2 player mode)

-2	-1	NORMAL	+1	+2
----	----	--------	----	----

(f) Guard damage (damage received on guard)

ON (OFF
------	-----

(g) Neutral guard (guard activated with lever in neutral)

ON	OFF
----	-----

(h) Round time (time [seconds] per round)

30	40	60	80	99
----	----	----	----	----

(i) Character change at continue (change of character for continued game)

YES (possible)	NO (not possible)
----------------	-------------------

(j) Character change at VS game (change of character when another player joins in) see note

YES (possible)	NO (not possible)
----------------	-------------------

(k) Sound in attract mode

YES (with sound)	NO (without sound)
------------------	--------------------

(l) Event mode (action after 2 player game has finished)

ON	OFF
----	-----

(m) Hit colour (colour of graphic effects when attacks are successful)

RED	YELLOW
-----	--------

(n) Attract Movie (movie shown in attract mode)

OFF	ON
-----	----

Note: When card is used, the game character cannot be changed even if the setting (j) has been set to YES.

6-2-6 Coin Options

1. Select Coin Options from the Main Test Menu. The following screen is displayed.

COIN OPTIONS	
Defaults in Green	
(a)	> Start cost: 1Credit to START
(b)	Continue cost: 1Credit to CONTINUE
(c)	Coin chute 1 mechanical value: 1Coin count as 1coin
(d)	Coin chute 2 mechanical value: 1Coin count as 1coin
(e)	Credit mode: COMMON
(f)	Coin counter: 1counter
(g)	Free play: NO
Modify :	P1-Left/Right
EXIT :	P1-Start

2. Use the Joystick UP/DOWN to step to the required adjustment.
3. Use the Joystick LEFT/RIGHT to adjust the value.
4. When all adjustments have been made, press P1 Start Button to return to the Main Test Menu screen

Note: When using a CashFlow acceptor ensure that Cost and Coin Chute values are set to 1

- (a) Start cost (number of credits to start a game)

1	2	3	4	5	6	7	8	9
---	---	---	---	---	---	---	---	---

- (b) Continue cost (number of credits to continue a game - must be equal to or smaller than start cost)

1	2	3	4	5	6	7	8	9
---	---	---	---	---	---	---	---	---

- (c) Coin chute 1 mechanical value (number of credits for each coin)

1	2	3	4	5	6	7	8	9
---	---	---	---	---	---	---	---	---

- (d) Coin chute 2 mechanical value (number of credits for each coin)

1	2	3	4	5	6	7	8	9
---	---	---	---	---	---	---	---	---

- (e) Credit Mode (credit storage and use)

<p>COMMON Credits are stored as a single account regardless of which coin switch or start switch is operated.</p>	<p>EACH ONE Different credit accounts are established. Credits from coin 1 are used by player 1 and credits from coin 2 are used by player 2</p>
--	---

- (f) Coin counter (assignment of coin meters)

<p>1 COUNTER Both coin switches share one coin counter</p>	<p>2 COUNTERS Each coin switch has its own coin counter</p>
---	--

- (g) Free play

YES (no coins required)	NO (coins required)
-------------------------	---------------------

6-2-7 Sound Test

1. Select Sound Test from the Main Test Menu. The following screen is displayed.

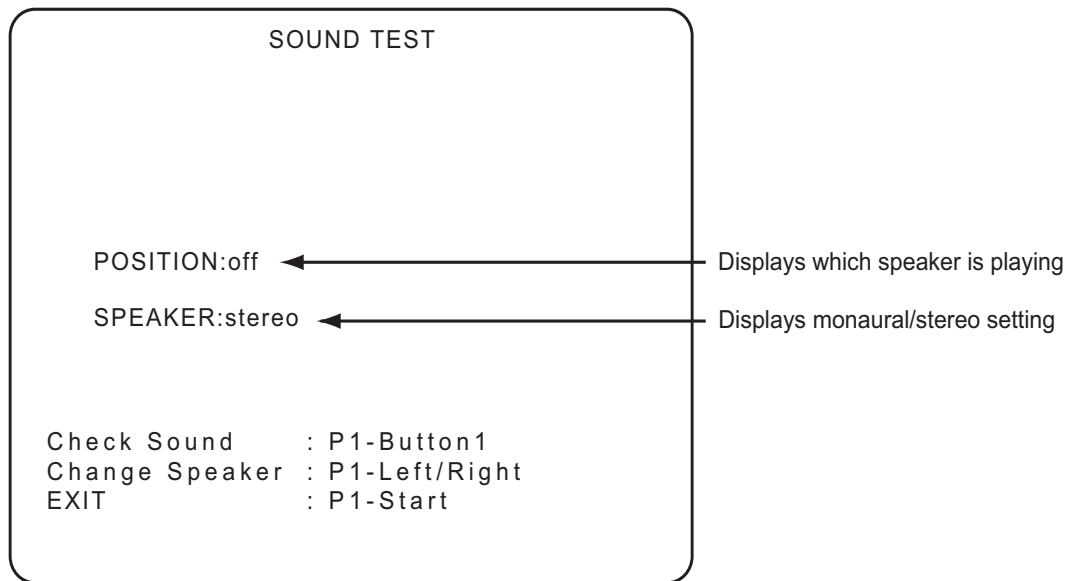

2. Press 1P Button 1 to conduct a stereo check. Sound will be produced from the left speaker only, then the right speaker only, then both speakers together. The display will show which speaker is active.
3. Use the Joystick LEFT/RIGHT to change between STEREO/MONO sound.
4. When testing has been completed, press P1 Start Button to return to the Main Test Menu screen

6-2-8 JVS Status

This test is inactive and not used on JAMMA system cabinets, it is only operational on JVS system cabinets.

6-2-9 Bookkeeping

- Select Bookkeeping from the Main Test Menu. The following screen is displayed.

Bookkeeping		ON TIME	0:00:00
Coin 1 Total	0	Play Ratio	0%
Coin 2 Total	0	1P Play Ratio	0%
Service Total	0	VS Play Ratio	0%
Freeplay Total	1		
	Total Time	Count	Average
1P Play	0:00:00	000	0:00:00
1P Cont.	0:00:00	000	0:00:00
VS Play	0:00:00	000	0:00:00
All Play	0:00:00	000	0:00:00
Next:		P1-Button1	
Exit :		P1-Start	

Bookkeeping		ON TIME	0:00:00	
CHARACTER DATA				
	Rate	Total	1P	VS
Raven	0%/	0 /	0 /	0
FENG	0%/	0 /	0 /	0
ASUKA	0%/	0 /	0 /	0
PAUL	0%/	0 /	0 /	0
JIN	0%/	0 /	0 /	0
LAM	0%/	0 /	0 /	0
KING	0%/	0 /	0 /	0
YOSHIMITSU	0%/	0 /	0 /	0
NINA	0%/	0 /	0 /	0
HWOARANG	0%/	0 /	0 /	0
↓ Downward				
Next:		P1-Button1		
Exit :		P1-Start		

Bookkeeping		ON TIME	0:00:00	
VS GAME WINNING AVERAGE DATA				
	WinAve	Total	Win	LoseVS
Raven	0%/	0 /	0 /	0
FENG	0%/	0 /	0 /	0
ASUKA	0%/	0 /	0 /	0
PAUL	0%/	0 /	0 /	0
JIN	0%/	0 /	0 /	0
LAM	0%/	0 /	0 /	0
KING	0%/	0 /	0 /	0
YOSHIMITSU	0%/	0 /	0 /	0
NINA	0%/	0 /	0 /	0
HWOARANG	0%/	0 /	0 /	0
↓ Downward				
Next:		P1-Button1		
Exit :		P1-Start		

Item	Description
COIN1 TOTAL	Total number of coins inserted
COIN2 TOTAL	Total number of coins inserted
SERVICE TOTAL	Number of times the Service switch was pressed
FREEPLAY TOTAL	Number of free play games
PLAY RATIO	Percentage of play hours in total power ON hours (Rounded to one decimal place)
1P PLAY RATIO	Percentage of single player play hours in total
VS PLAY RATIO	Percentage of tournament mode play hours in total
TOTAL TIME	Total play hours
COUNT	Number of game plays
AVERAGE	Average play time
CHARACTER DATA	Number of times each game character was selected by players, and percentage in total
VS GAME WINNING AVERAGE DATA	Number of times each game character was selected by players for tournament game, and percentage of wins

6-2-10 Data Clear

1. Select Data Clear from the Main Test Menu. The following screen is displayed.

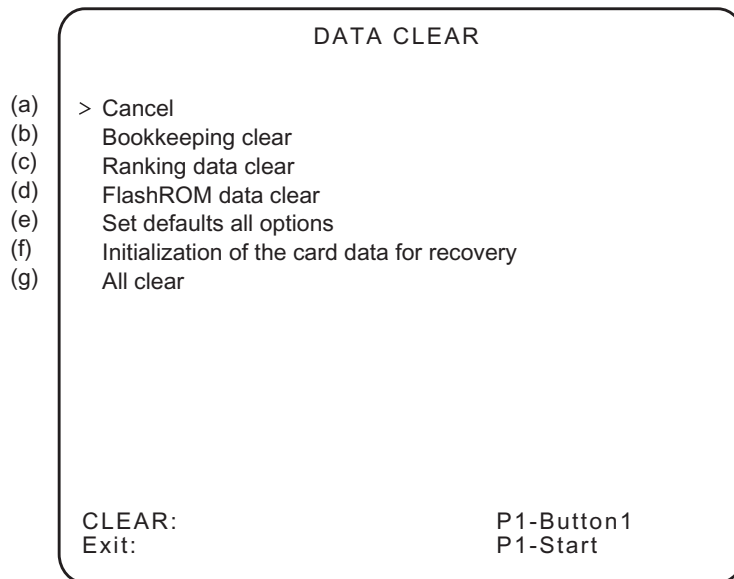

2. Use the Joystick UP/DOWN to step to the required adjustment.
3. When all adjustments have been made, press P1 Start Button to return to the Main Test Menu screen
 - (a) Returns to the Main Test Menu.
 - (b) Resets all Book Keeping data to zero
 - (c) Resets all ranking data such as record of consecutive wins to factory default
 - (d) Initializes the data stored in the flash memory, such as ghost data and replay data.
 - (e) Resets all Game and Coin Options to factory default.
 - (f) Deletes the information for the card data restoration.
 - (g) Returns ALL data and settings to defaults.

6-2-11 Card Options (Where Fitted)

This test is used to set the Read/Write unit and TEKKEN-NET IDcard.

1. Select Card Options from the Main Test Menu. The following screen is displayed.

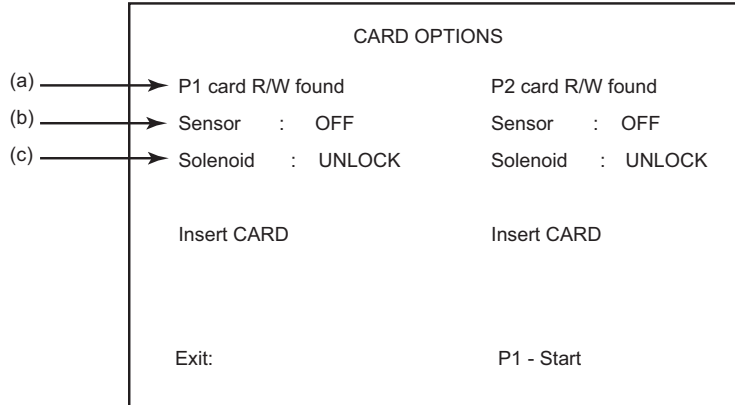

Item	Options	Description
(a) P1 card R/W found (P2 card R/W found)	[found] or [not found]	Displays [found] if the card R/W unit is connected to the Game PC board, and displays [not found] if it is not connected.
(b) Sensor	[ON] or [OFF]	Displays [ON] when a card is inserted in the card R/W unit, and displays [OFF] when there is no card in the card R/W unit
(c) [UNLOCK] or [LOCK]	[UNLOCK] or [LOCK]	As soon as the card is inserted into the card R/W unit, the card is locked into position and the screen displays "LOCK". If the card is not locked in position, the screen displays "UNLOCK"

2. To conduct a test or data restoration, insert a card into the Read/Write unit

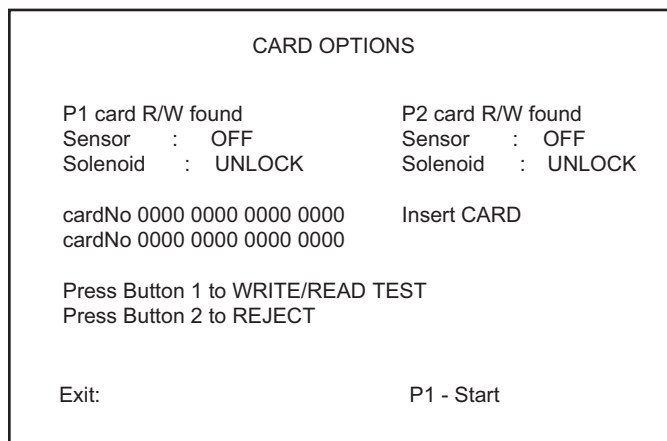

** Note: The above is an example of the screen display when two cards are inserted into the P10-side card R/W unit*

Display after card insertion

Item	Description
CardNo 0000 0000 0000 0000 CardNo 0000 0000 0000 0000	When a card is inserted in the card R/W unit, the 16-digit number (access code) printed on the reverse of the inserted card is displayed on the screen. When two cards are inserted, the access codes for both cards are displayed in two rows

If a card is inserted in the P1-side card R/W unit, press the P1 Button switch 1 to conduct the card read/write test. If a card is inserted in the P2-Side card R/W unit, press the P2 Button switch 1 to conduct the card read/write test. To eject the card from the card R/W unit, press the Button switch 2 on the side in which the card is inserted.

CARD OPTIONS	
P1 card R/W found	P2 card R/W found
Sensor : OFF	Sensor : OFF
Solenoid : UNLOCK	Solenoid : UNLOCK
READ DATA ERROR	Insert CARD
cardNo 0000 0000 0000 0000	
Press Button 1 to WRITE/READ test	
Press Button 2 to REJECT	
Press Button 3 to Restore Data *Note 1	
Exit:	P1 - Start

** Note 1: This item is only shown when an error card is inserted*

Item	Description
CARD READ ERROR	This indicates that a card other than a TEKKEN-NET ID card was inserted and data could not be read.
CARD WRITE ERROR	This indicates that the Write test has failed.
READ DATA ERROR	This indicates that comparison of the data after the write test resulted in a mismatch.
WRITE READ OK	This indicates that both read and write operations were successful.

** Note 1: Conducting the card read/write test will not damage the game play data on the card.*

** Note 2: When two cards are inserted, the card read/write test cannot be performed.*

If a card on which a write error was generated is inserted or if a card on which data was destroyed due to power-off during data writing is inserted, pressing the Button switch 3 of the applicable player side initiates an attempt to restore the data on the card.

Card data may or may not be restored depending on the condition of the card, as described below.

- Data may only be restored with the card that was used to play the game with the Game PC board that you are working on and has been set to the test mode. It should be noted that there is a limit to the amount of data saved (10 cases max.).
- If a write error was indicated during a game play, it may be possible to restore the data successfully.
- If a power interruption occurred when data was being written to the card, it may be possible to restore the data successfully.
- If the card was pulled out during a game play, the data cannot be restored.
- Data restoration can be tried only once for one error.
- Data restoration cannot be conducted with a card whose access code is different from the data stored in the cabinet.
- Data cannot be restored with a card which disallows data reading or writing due to damage.

To return to the test menu screen, press P1 Start switch.

6-2-12 Close Setting (When Card Reader Fitted)

This mode is used to set the site closing time, and prevents the card from being used from 15 minutes before the set time. This ensures that data is not lost if the game is powered-down during game play.

The time can be set between 19:00 and 31:00 (7:00 am on the following day), or 24 hour operation.

The same closing time can be set for every day, or the the closing time can be set differently for each day of the week.

1. Select Close Setting from the Main Test Menu. The following screen is displayed.

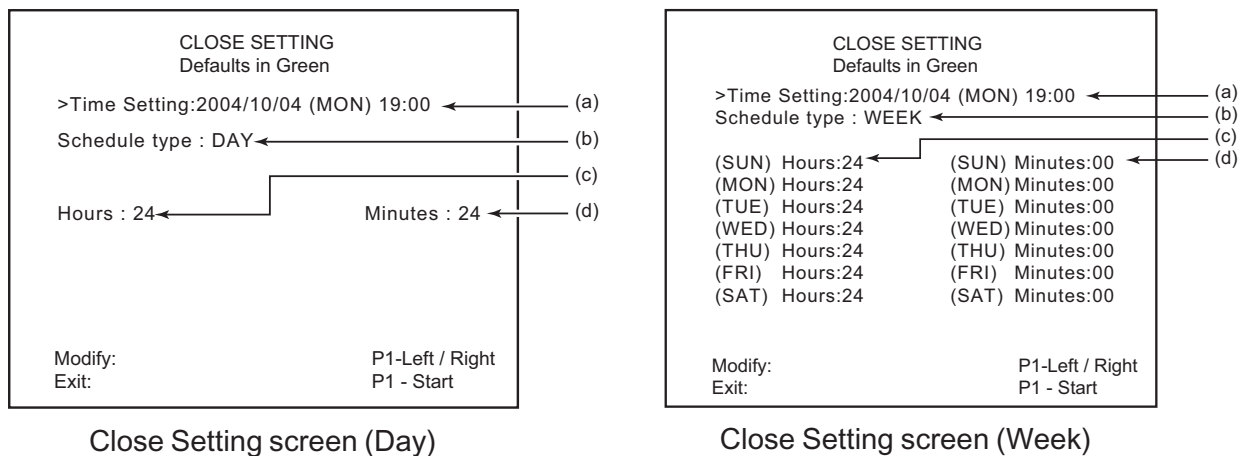

2. Use the joystick Up/Down to scroll through the options and the joystick Left/Right to change the settings.

Item	Setting Options	Default	Description
(a) TIME SETTING			Set the current time
(b) SCHEDULE TYPE	[DAY]<=>[WEEK]	[DAY]	Select daily setting [DAY] or weekly setting [WEEK]. *note 1
(c) HOURS	[24]=>[25]=>[26]=>[27]=>[28]=>[29]=>[30]=>[31] [ALLDAY]=>[19]=>[20]=>[21]=>[22]=>[23]=>[24]	[ALLDAY]	Set the [HOURS] for closing time setting. Select [ALLDAY] if the machine is made available 24 hours of the day.
(d) MINUTES	[00]=>[15]=>[30]=>[45]=>[008]=>....	[24HOURS]	Select [MINUTES] for closing time *note 2

*Note 1: When [DAY] is selected, the same closing time applies to every day of the week, and the machine disallows the use of card 15 minutes before the set closing time.

The machine begins accepting cards from 7:00am, except when [ALL DAY] is set.

*Note 2: When [HOURS] is set to [30], the [MINUTES] indication becomes fixed at [00]. When [ALL DAY] is set, "(24 HOURS)" is indicated.

Example: When [HOURS] and [MINUTES] are set to [25] and [30], respectively, the daily closing time will be 1:30am, and the machine will stop accepting cards at 1:15am.

Select "Time Setting" and press the P1 Button switch to display the time setting screen shown below.

CLOSE SETTING(CARD)
Defaults in Green

Now 2004 /10 / 04 (MON) 19:00:00

>Year : 2004 ← (a)

Month : 10 ← (b)

Day : 04 ← (c)

Hour : 19 ← (d)

Minute : 00 ← (e)

Modify: P1-Left / Right
Exit: P1 - Start

Close Setting screen (Time Setting)

Item	Setting Options
(a) YEAR	Set the current Year.
(b) MONTH	Set the current Month.
(c) DAY	Set the current Day. (Sunday is Day 01)
(d) HOURS	Set the Hours of the current time.
(e) MINUTES	Set the Minutes of the crrent time.

* Note:The day of the week is automatically displayed when the [DAY] setting is entered.

To return to the test menu screen, press the P1 Start switch.

Copies of Namco Game Manuals can be downloaded from our **website:**

www.namco.co.uk

They are located under Components, Sales and Service

For all Parts or Technical Support contact:

Brent Electronic,
Namco House,
Units 5-8, Acton Park Estate,
The Vale,
London. W3 7QE

www.brentelectronic.co.uk

For Technical Support, Warranty and

Advance Replacement Parts:-  +44 (0) 20 8324 6120

For Consumable Parts:-  +44 (0) 20 8324 6102

Fax for both:-  +44 (0) 20 8324 6126