



CHIP UPDATE KIT

INSTRUCTIONS

(Turkey Hunting USA to Deer Hunting USA)

 **Sammy USA Corporation**

901 Cambridge Drive
Elk Grove Village, IL 60007
Phone: (847) 364-9787
Fax: (847) 364-9831
888-US-SAMMY
www.sammyusa.com

CONTENTS

PLEASE READ BEFORE INSTALLING...	Page 1
1. CHIP UPDATE KIT PACKAGE CONTENTS	Page 2
2. CONNECTOR TABLES	Page 3
3. DIP SWITCH TABLES	Page 4
4. HOW TO INSTALL THE CHIP UPDATE KIT	Page 5, 6, 7
5. TEST MODE	Page 8, 9, 10
6. TROUBLE WITH GUN SHOOTING	Page 11
WARRANTY	Page 11
SERVICE TIP (GUNSHOT ACCURACY IMPROVEMENT)	Page 12

EXCITING FEATURE!!

The blood color can be changed from RED (Factory setting) to YELLOW.
See Dip Switch tables (page 4).

PLEASE READ BEFORE INSTALLING THE TURKEY HUNTING USA KIT

The TURKEY HUNTING USA KIT is designed only for a Normal resolution monitor. The High or Medium resolution monitor will not work for TURKEY HUNTING USA.

MIS-CONNECTING THE GUN CONNECTOR

When you connect the Gun unit to Main PCB, you must make sure and connect to the correct connectors which are CN 5 and CN 6 connectors.

If you connect Gun unit to CN 2, 8 pin connector, your PCB will sustain serious damage.

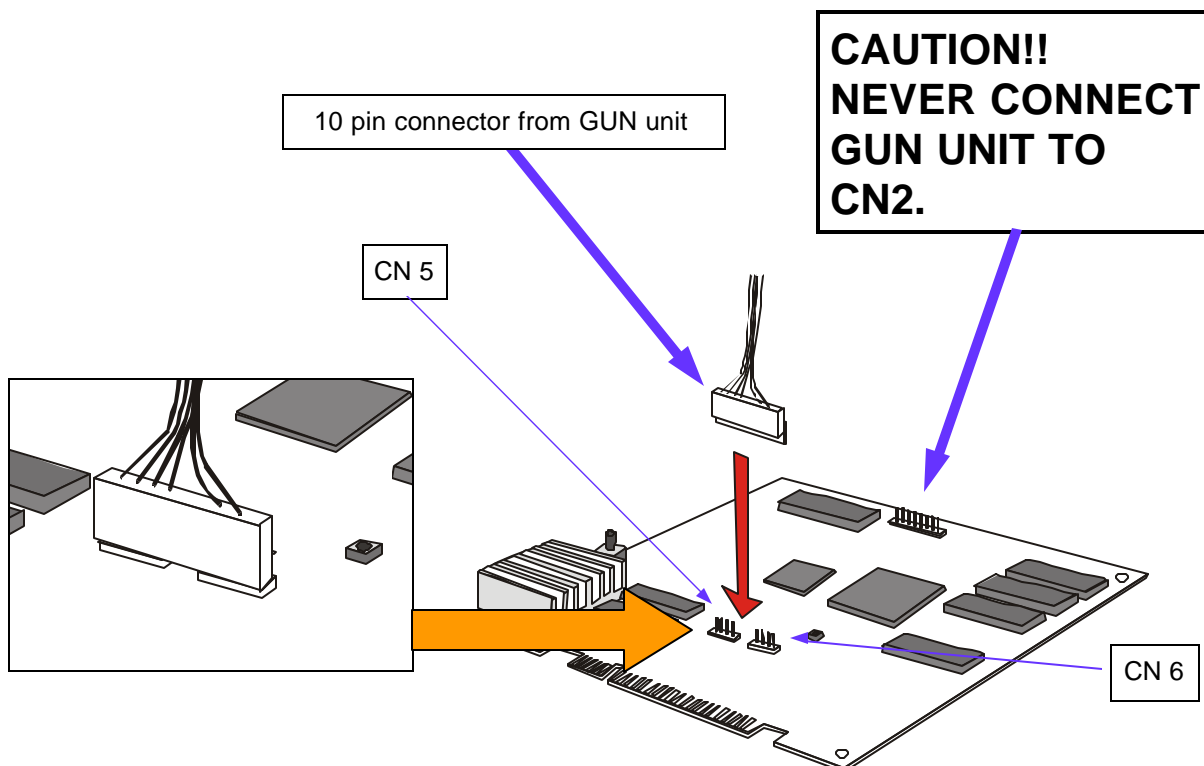

1. CHIP UPDATE KIT PACKAGE CONTENTS



CHIP UPDATE KIT

A MASK ROM set (5 PCS/SET)
Part#: 36-90-800

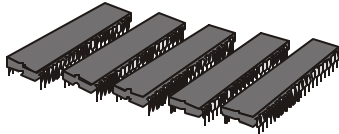

B START button Assy
Part#: 36-50-013



C Instruction Decal Sheet
Part#: 36-30-210

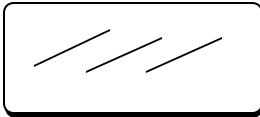

D "Pump Before shoot" Decal
Part#: 36-30-224

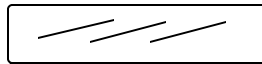

E Program EP-ROM set (2 PCS/SET)
Part#: 36-50-013

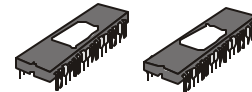

F Marquee Styrene
Part#: 36-30-100



G Control Overlay
Part#: 36-30-150

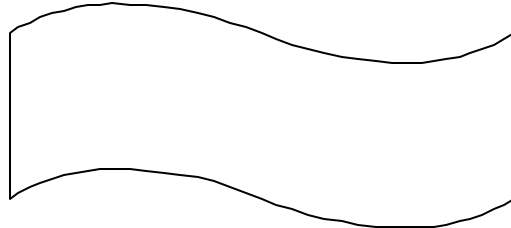

H Side Decal (2 sheet)
Part#: 36-30-200



K Conversion Kit Instructions
Part#: 36-30-301



L AAMA Sticker
Part#: 99-30-750



2. CONNECTOR TABLES



CHIP UPDATE KIT

JAMMA CONNECTOR					
MAIN P.C.BOARD					
SOLDER SIDE			COMPONENT SIDE		
FUNCTION	COLOR	PIN #	PIN #	COLOR	FUNCTION
GROUND	BLK	A	1	BLK	GROUND
GROUND	BLK	B	2	BLK	GROUND
+5VDC	RED	C	3	RED	+5VDC
+5VDC	RED	D	4	RED	+5VDC
		E	5		
+12VDC	BLU	F	6	BLU	+12VDC
KEY		H	7		KEY
COIN METER B		J	8	BLU/BRN	COIN METER A
COIN LOCKOUT B		K	9		COIN LOCKOUT A
SPEAKER(-)	BLK	L	10	WHT/BLK	SPEAKER(+)
		M	11		
VIDEO GREEN	GRN	N	12	RED	VIDEO RED
VIDEO SYNC	WHT	P	13	BLU	VIDEO BLUE
SERVICE CREDIT SWITCH	BRN/WHT	R	14	BLK	VIDEO GROUND
		S	15	WHT/GRY	TEST SWITCH
COIN SWITCH B		T	16		COIN SWITCH A
		U	17		1P START BUTTON
		V	18		
		W	19		
		X	20		
		Y	21		
		Z	22		
		a	23		
		b	24		
		c	25		
		d	26		
GROUND	BLK	e	27	BLK	GROUND
GROUND	BLK	f	28	BLK	GROUND

CN6 - 4 PIN SUB CONNECTOR		
MAIN P.C.BOARD		
PIN #	COLOR	FUNCTION
1		
2	GREEN	PUMP SWITCH
3	BROWN	PUMP SWITCH
4		

CN5 - 4 PIN SUB CONNECTOR		
MAIN P.C.BOARD		
PIN #	COLOR	FUNCTION
7	RED	+5VDC
8	WHITE	TRIGGER SWITCH
9	BLACK	GROUND
10	BLUE	OPTICAL

3. DIP SWITCH TABLES



CHIP UPDATE KIT

DIP SWITCH 1		SWITCH POSITIONS							
FUNCTIONS	SETTING	1	2	3	4	5	6	7	8
COIN CHUTE 1	1 COIN 1 CREDIT	OFF	OFF	OFF					
	2 COINS 1 CREDIT	ON	OFF	OFF					
	4 COINS 1 CREDIT	OFF	ON	OFF					
	1 COIN 2 CREDITS	ON	ON	OFF					
	1 COIN 3 CREDITS	OFF	OFF	ON					
	1 COIN 4 CREDITS	ON	OFF	ON					
	1 COIN 5 CREDITS	OFF	ON	ON					
	1 COIN 6 CREDITS	ON	ON	ON					
COIN CHUTE 2	1 COIN 1 CREDIT				OFF	OFF	OFF		
	2 COINS 1 CREDIT				ON	OFF	OFF		
	4 COINS 1 CREDIT				OFF	ON	OFF		
	1 COIN 2 CREDITS				ON	ON	OFF		
	1 COIN 3 CREDITS				OFF	OFF	ON		
	1 COIN 4 CREDITS				ON	OFF	ON		
	1 COIN 5 CREDITS				OFF	ON	ON		
	1 COIN 6 CREDITS				ON	ON	ON		
DISCOUNT to CONTINUE	NO DISCOUNT							OFF	
	START 2 COINS CONTINUE 1 COIN							ON	
TEST MODE	OFF								OFF
	ON								ON

DIP SWITCH 2		SWITCH POSITIONS							
FUNCTIONS	SETTING	1	2	3	4	5	6	7	8
MONITOR SETTING 1	<i>NORMAL</i>	OFF							
	REVERSE VERTICAL	ON							
MONITOR SETTING 2	<i>NORMAL</i>		OFF						
	REVERSE HORIZONTAL		ON						
ATTRACT SOUND	<i>ON</i>			OFF					
	OFF			ON					
DIFFICULTY LEVEL	<i>NORMAL</i>				OFF	OFF			
	EASY				ON	OFF			
	HARD				OFF	ON			
	HARDEST				ON	ON			
BLOOD COLOR	<i>RED</i>						OFF		
	YELLOW						ON		
CHANCES	<i>3</i>							OFF	
	4							ON	
GUN TYPE	<i>PUMP ACTION GUN UNIT</i>								OFF
	HAND GUN UNIT								ON

"FACTORY INSTALLED" SETTING



CHIP UPDATE KIT

4. HOW TO INSTALL THE CHIP UPDATE KIT

1. Exchange the ROMS

There are 5 pcs of MASK-ROMS and 2 pcs of Program EP-ROMS on Turkey Hunting USA Main PCB. Remove the Turkey Hunting USA Main PCB from your cabinet. Refer to the position of all ROMS as shown below to exchange to the Deer Hunting USA ROMS.

MAIN P.C.BOARD, LAYOUT

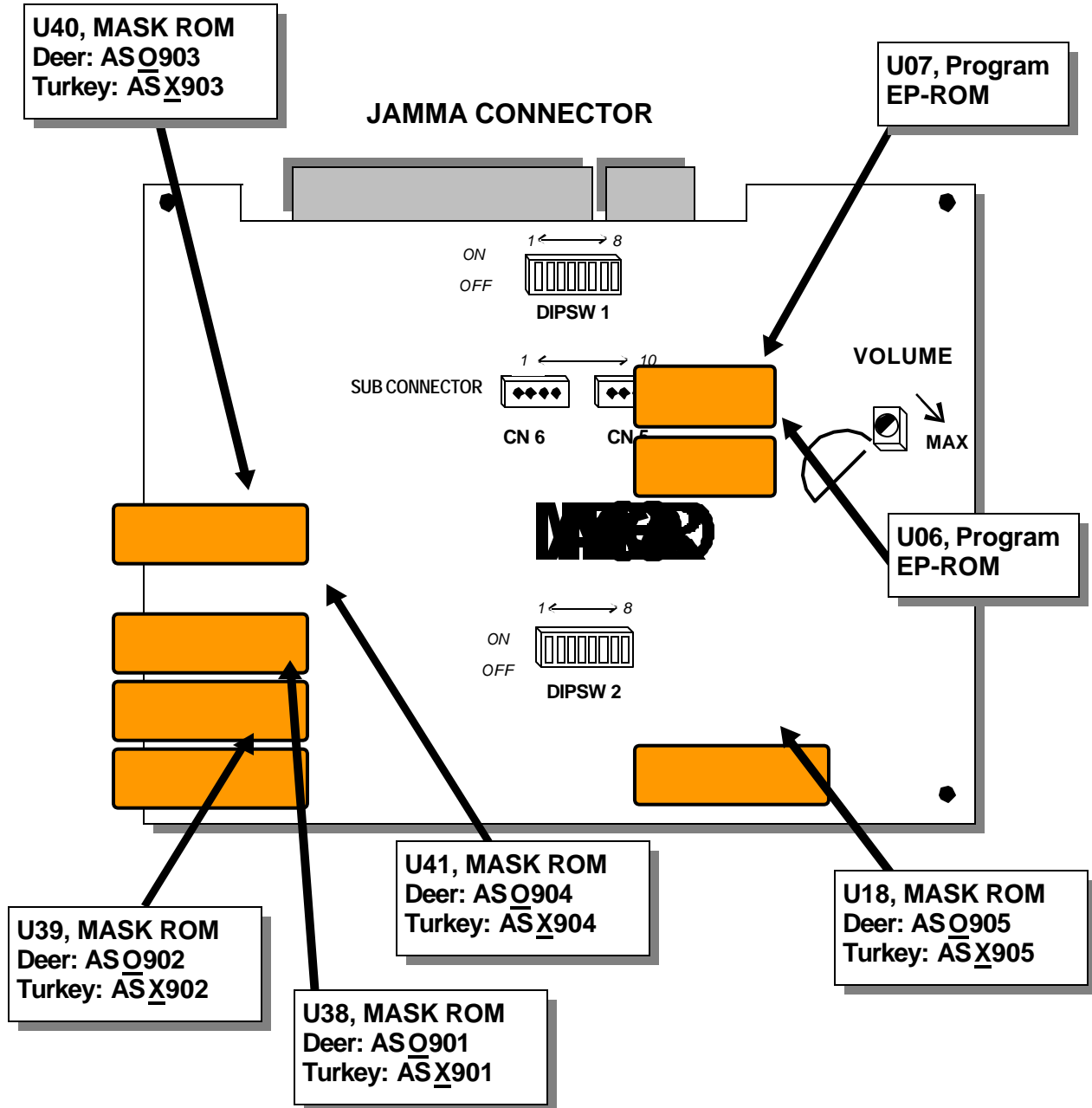



2. Change the GAME CABINET

• MARQUEE STYRENE

Change the old marquee to the TURKEY HUNTING USA Marquee Styrene. **NOTE:** If the TURKEY HUNTING USA Marquee Styrene does not fit your cabinet, you should cut the marquee to fit.

• CONTROL PANEL

Change the parts on the control panel. Take off the old parts (Gun unit assy) and the old push button assys from the control panel. Then put on the TURKEY HUNTING USA Control Panel Overlay.

NOTE: After you put on the TURKEY HUNTING USA Control Panel Overlay, you must make the holes for the TURKEY HUNTING USA Gun Assy, Gun Holster and Push Button Assy. See sample layout below. Or if you want, install Gun Assy or Gun Holster on the side of cabinet.

MOUNTING GUN HOLSTER

You can mount the GUN HOLSTER to the top of the control panel.

To mount it, use HOLSTER as a template for drilling holes. Use a hex wrench to tighten screws.

For a Small size Control Panel (see example)

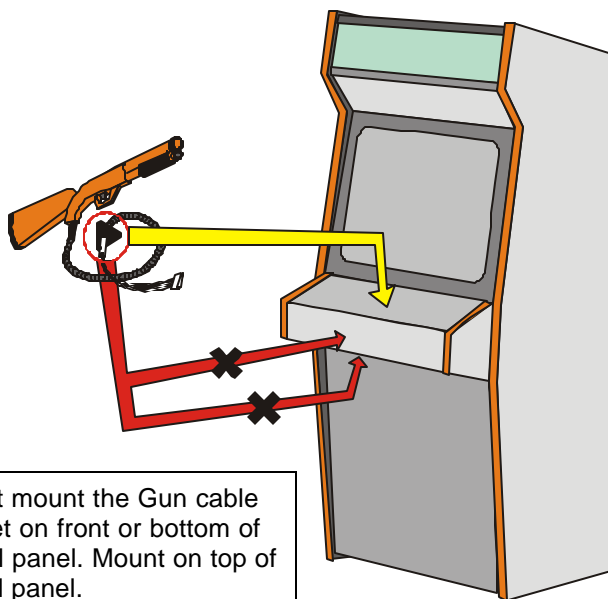

Do not mount the Gun cable bracket on front or bottom of control panel. Mount on top of control panel.

Recommended Holster bracket mountings

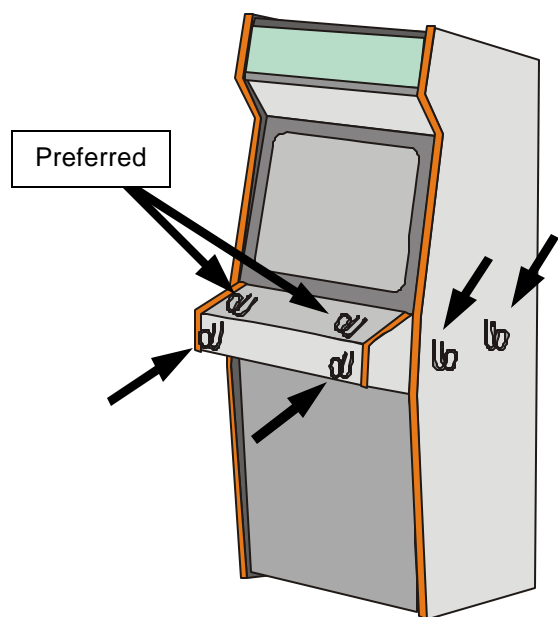

MOUNTING DIMENSIONS FOR PUSH BUTTON ASSY

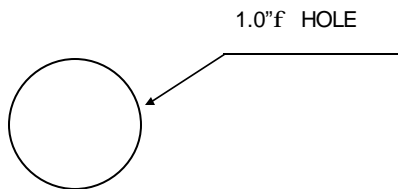

MOUNTING DIMENSIONS FOR GUN ASSY

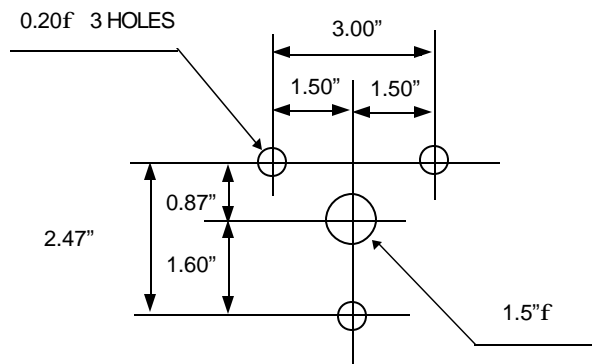

IF YOU WANT TO INSTALL HAPP'S PISTOL GUN:

You can use HAPP'S PISTOL GUN instead of the original pump action gun for this game.

WARNING

Be absolutely sure that the connector for the HAPP'S PISTOL GUN matches exactly the pin position for CN5 as shown on page 4.

Connect gun connector to CN5 and turn on Dip switch 2, #8. See pages 1, 4 & 5 for details.

- **INSTRUCTION DECAL SHEET**
Put "PUMP BEFORE SHOOTING" Decal Sheet on the front glass of the monitor.

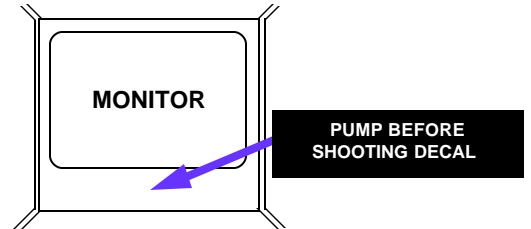

- **AAMA "ANIMATED VIOLENCE MILD" STICKER**
Place AAMA sticker on the upper left hand side corner of the marquee.

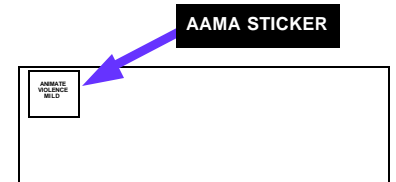

Remove old P. C .Boards and install new P. C. Board in its place.

3. Connect the HARNESES

- **JAMMA HARNESS**
Connect the JAMMA Harness to the edge connector on the DEER HUNTING USA Main P.C.BOARD.
- **GUN HARNESS**
Connect the Gun Harness to the Gun Connectors located on the Main P.C. Board components side. There are CN5 and CN6 connectors on the P.C. BOARD. Connect Gun Connector to CN5 and CN6, correctly, as shown below.

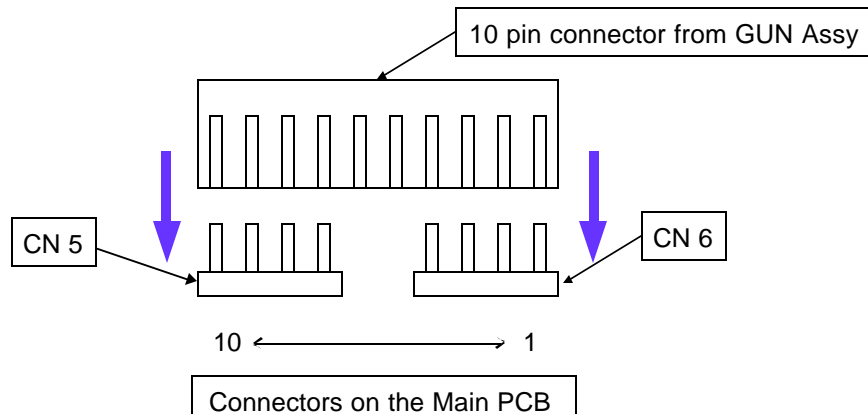



CHIP UPDATE KIT

5. TEST MODE

Entering the TEST MODE

If you need to check the condition of the game circuitry and controls, you can use the TEST MENU. Turn ON "DIP SWITCH 1, #8" and re-power on the game. The game will go into TEST MODE (diagnostics) and the screen appears as follows:

Select TEST

Use this screen to choose which of the 7 screens you want to see. Move cursor using the START BUTTON. Then pull the TRIGGER to enter the function.

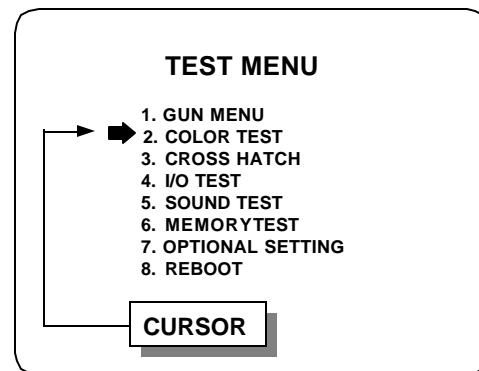

1. GUN MENU

You can adjust the GUN unit in GUN ADJUST mode.

Gun Adjust

1. Enter TEST MENU and select GUN ADJUST.
2. Shoot center mark only with gun sight.
3. If you need more accuracy, try again.
4. Press START button to save Gun accuracy and enter GUN TEST mode, press START button again to go back to Main menu.

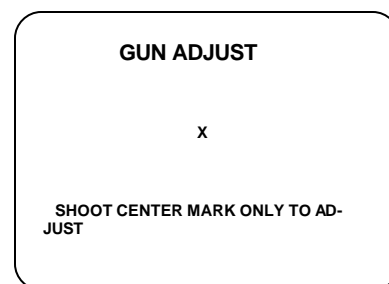

You can test accuracy in GUN TEST mode.

Gun Test

1. At Gun Adjust screen, press START button to go to test mode.
2. Shoot all around the screen to see Gun's accuracy.
3. Press START button to go back to Main menu.



2. COLOR TEST

Use this screen to check the color of monitor. The color blocks in the center should be four bands (Red, Green, Blue and White from top to bottom), each with a color scale from dark to bright, left to right. If the screen does not match this description, adjust the Monitor as described in the Monitor's manual.

* Press the START button to exit and go back to the TEST MENU screen.

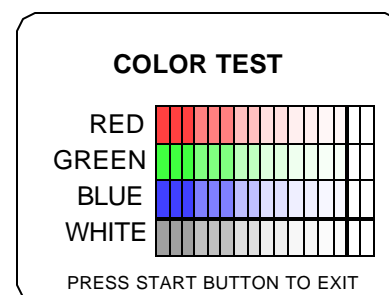

3. CROSS HATCH

Use this screen to check the size of picture. The CROSS HATCH test pattern has a White grid on a Black background. Check following:

- The grid line should be straight, and the lines should not have excessive pincushion or barrel distortion.
- "Out"line of grid line is the same size as "Out"line of game screen. So, "Out"line should be able to be seen with no overflow of grid lines on screen.

If these are not as above, adjust the Monitor as described in the Monitor's manual.

- * You can exit and go back to the TEST MENU screen by press START button.

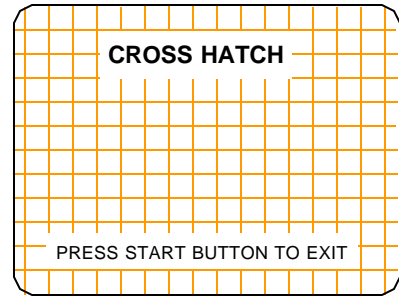

4. I/O TEST

Use this screen to check the switches in this game. To check the functioning of each switch, activate it and watch the corresponding OFF letters change to ON. If the ON and OFF letters do not appear correctly, check the Harness connections and Switches.

- * Press START button and Gun trigger simultaneously to exit.

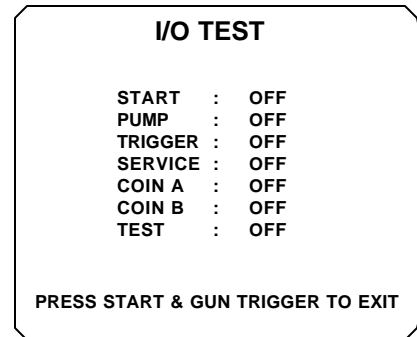

5. SOUND TEST

Use this screen to check all game sounds. Choose a sound with the START button. Then pull the TRIGGER. You can check each sound in this game.

- * Press START button and Gun trigger simultaneously to exit.

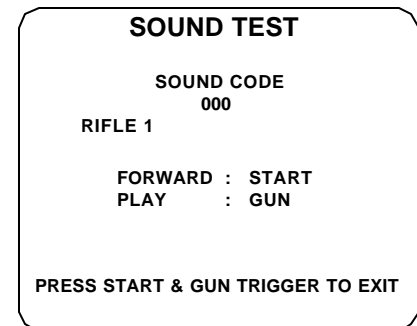

6. MEMORY TEST

Use this screen to check RAM and ROM on the Main P.C.B. The Main P.C.B. will automatically check them when you enter this screen. If there are no problems, the word **OK** will appear on screen. If you get the word **ERROR**, check the mounting of RAMs or ROMs on the Main P.C.B. and if **ERROR** reappears, it needs to be replaced.

- * This mode will automatically exit after testing is finished.

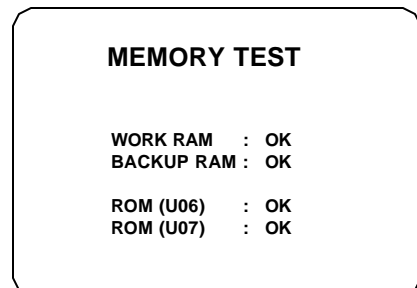

7. OPTIONAL SETTING

HIGH SCORE CLEAR

If you desire to clear HIGH SCORE data, do the following.

HOW TO SET UP

1. Enter TEST MENU and select OPTIONAL SETTING.
2. Press START BUTTON to choose HIGH SCORE CLEAR.
3. Select YES by pressing START BUTTON and pressing GUN TRIGGER to clear HIGH SCORE data.
4. The screen will return to previous screen automatically after clearing HIGH SCORE data.

OPTIONAL SETTING

1. HIGH SCORE CLEAR
2. GUN ADJUST DEFAULT
3. RETURN TO TEST MENU
PRESS START BUTTON TO CHOOSE
PRESS GUN TRIGGER TO SELECT

HIGH SCORE CLEAR

ARE YOU SURE YOU WANT TO
CLEAR HIGH SCORE?

YES
→ NO

PRESS START BUTTON TO
CHOOSE
PRESS GUN TRIGGER TO SELECT

NOTE: Do not proceed if Gun test is accurate.

GUN DATA DEFAULT

If you have a problem with Gun sighting, you may have to clear the Gun data.

After clearing Gun data, the game will be reset to **factory default setting**.

See the following for how to clear saved data.

1. Enter TEST MENU and select OPTIONAL SETTING.
2. Press START BUTTON to choose GUN ADJUST DE-FAULT.
3. Select YES by pressing START BUTTON and pressing GUN TRIGGER to clear Gun data.
4. The screen will return to previous screen automatically after clearing Gun data.

GUN ADJUST DE-

FAULT

ARE YOU SURE YOU WANT TO SET
GUN ADJUST DEFAULT?

YES
→ NO

PRESS START BUTTON TO
CHOOSE
PRESS GUN TRIGGER TO SELECT

8. REBOOT

Use this screen to go back to normal game mode. After selecting this function, the game will automatically take you to the normal game screen. Make sure to turn OFF "DIP SWITCH 1, #8" or you will return to test mode upon powering on.

Returning to GAME MODE

You can return to normal game mode by doing one or the other of the following:

Turn OFF "DIP SWITCH 1, #8" and re-power on the game.

Select REBOOT at TEST MENU. (But you will have to make sure to turn OFF "DIP SWITCH 1, #8".)

6. TROUBLE WITH GUN SHOOTING



CHIP UPDATE KIT

If you have trouble because you can't shoot to the corner of the screen, you may have to adjust the monitor brightness. Turn up the monitor brightness until you can shoot the corner of screen.

Plus, monitors tend to develop a magnetic field from continuous use, which could cause the gun unit not to function properly. Therefore, it is recommended that the monitor is demagnetized [Degaussed] every so often in order to keep the gun unit functioning properly.

In addition, the following conditions of the monitor may result in Gun shooting problems:

- ? Picture burned on monitor screen
- ? Over gaused monitor
- ? Non adjustable brightness feature

Also, the following conditions of the cabinet may result in Gun shooting problems.

- ? Combination of low performing adjustable brightness monitor and low reflection mirror
- ? Dirty monitor screen or monitor glass

WARRANTY

Limited warranty, Repair and Return Policy

Sammy USA Corporation warrants all products to be free from defective materials and workmanship for a period of thirty (30) days from the Sammy USA Corporation invoice date unless otherwise specified in writing by Sammy USA Corporation. The extent of this warranty applies to all electronic assemblies only, and does not include lamps and fuses.

This limited warranty is invalid for any product that upon examination, is deemed to have been subject to misuse, improper repair or installation, neglect or violation of specification or other instructions published by Sammy USA Corporation.

There are no additional warranties which extend beyond those limited warranties described above. The limited warranties described above shall be in lieu of any other warranty, express or implied, including but not limited to any implied warranty of merchantability or fitness for a particular purpose.

Return Merchandise Authorization

1. Contact your authorized Sammy USA distributor to receive a Return Merchandise Authorization for return.
2. You must obtain RMA numbers from Sammy USA Corporation through an authorized Sammy USA distributor. Please have your serial number available when calling for an RMA number.
3. All items must have an RMA number marked clearly on the outside of the package.
4. Products must be shipped prepaid. Products returned without an RMA number will not be accepted.
5. Credits to accounts are subject to inspection of products for damage and suitability for resale.



SERVICE TIP

GUNSHOT ACCURACY IMPROVEMENT

If you have trouble because you can't calibrate the gun unit properly. For example you can't shoot corner of screen or you can shoot only in the center of the screen, do the following:

- 1) CHECK THE +5V LINE **ON THE PCB**. YOU CAN CHECK VOLTAGE AT THE JAMMA EDGE CONNECTOR BETWEEN PIN #2 AND #3.
- 2) ADJUST +5V LINE TO +5.25V BY TURNING UP POTENTIOMETER ON THE POWER SUPPLY.

WARNING: DO NOT TURN UP VOLTAGE MORE THAN +5.25V OTHERWISE YOUR PCB WILL SUSTAIN SERIOUS DAMAGE.

- 3) ENTER BACK UP CLEAR IN TEST MODE, THEN SELECT YES TO CLEAR BACK UP DATA.

NOTE: YOU DON'T HAVE TO DO "GUN ADJUST" IN TEST MODE.

- 4) ENTER GUN TEST IN TEST MODE TO CHECK GUNSHOT. IF THE GUNSHOT IS NOT CORRECTED REPEAT STEP #3.