

STARGATE

INSTRUCTION MANUAL



For service...
**NOTE NEW TOLL-FREE
TELEPHONE NUMBERS:**

800-621-1253
In Illinois call:
800-572-1324

Williams® 
ELECTRONICS, INC.

An Xcor International Inc., Company
3401 N. California Av., Chicago, IL 60618
Cable Address: WILCOIN, CHICAGO
(312) 267-2240

ROM SUMMARY

ROM	PART NO.	DESCRIPTION
STARGATE 1A	A-5343-09700	ROM, 4Kx8
STARGATE 2A	A-5343-09701	ROM, 4Kx8
STARGATE 3A	A-5343-09702	ROM, 4Kx8
STARGATE 4A	A-5343-09703	ROM, 4Kx8
STARGATE 5A	A-5343-09704	ROM, 4Kx8
STARGATE 6A	A-5343-09705	ROM, 4Kx8
STARGATE 7A	A-5343-09706	ROM, 4Kx8
STARGATE 8A	A-5343-09707	ROM, 4Kx8
STARGATE 9A	A-5343-09708	ROM, 4Kx8
STARGATE 10A	A-5343-09709	ROM, 4Kx8
STARGATE 11A	A-5343-09710	ROM, 4Kx8
STARGATE 12A	A-5343-09711	ROM, 4Kx8
Decoder ROM 4 (Horizontal)	A-5342-09694	ROM, 512x8
Decoder ROM 5 (Vertical)	A-5342-09695	ROM, 512x8
Video Sound ROM 2	A-5343-09809	ROM, 2Kx8

INSTALLATION

1. Move the cabinet close to desired location and unlock the upper rear door panel. Remove the door and set it aside.
2. Unlatch and swing open the lower rear door.
3. Check that five fuses on the power supply and two fuses on the Sound Board are securely installed in their fuse clips. Also check that the 3A line fuse on the power panel is secure in its clips.
4. Unlock the coin door. Reach through the coin door opening and unlatch the control panel. Unhook the control panel safety chain and lower the control panel.
5. Check that the following connectors are firmly seated and that no wires are broken or termination pins loose in the connector.
 - a. Coin door connector.
 - b. Control panel connector.
 - c. Monitor control 6-pin connector and monitor power connector.
 - d. Transformer connector at the power panel.
 - e. Three connectors on the Power Supply.
 - f. Four connectors on the Sound Board.
 - g. Five connectors on the CPU/Video Board.
 - h. Three connectors on the ROM Board.
 - i. Two connectors on the Interface Board.
6. Check that the socketed ICs are firmly seated in their sockets (CPU Video Board -3, ROM Board -12, and Sound Board -2).
7. If it is desired to check or change game adjustments, refer to Game Adjustment procedures which follow.
8. Extend the line cord from the game and insert it in the slot in the lower door frame.
9. Swing the lower door closed and latch it.
10. Install and lock the upper rear door.
11. Reconnect the control panel safety chain and latch the control panel in position.
12. Close and lock the coin door.

POWER TURN-ON

This game **MUST BE PLUGGED INTO A PROPERLY GROUNDED OUTLET** to **PREVENT SHOCK HAZARD** and to ensure **PROPER GAME OPERATION**. **DO NOT** use a "cheater" plug to defeat the ground pin on the line cord, and **DO NOT** cut off the ground pin. The line voltage must agree with that specified on the back of the cabinet or serious damage to the machine could occur. For low-line voltage applications (105v AC or 200v AC), refer to the power wiring diagram.

1. With the game plugged into a properly grounded outlet, locate the POWER ON/OFF switch located at the top right-hand corner of the cabinet rear and switch it ON. General illumination should come on and a scanning pattern should appear on the screen as the game sequences through ROM, RAM, and CMOS RAM data checks.
2. If ROM and RAM tests are successful "0" is first indicated on the ROM Board 7-segment Diagnostic Display. A few seconds later the following message is indicated on the monitor:

INITIAL TEST INDICATES
ALL SYSTEMS GO

3. If a RAM error is detected, the 7-segment LED first displays a "1" to indicate a RAM failure. Next, the bank number (1, 2, or 3) and finally the chip of the bank (1 to 8). Then there is a pause and the LED display sequence is repeated. Next, another pause occurs and then the CRT displays a "RAM ERROR XY" where X is the bank number and Y is the chip of that bank.
4. If a ROM error is detected, the 7-segment LED first displays a "2" to indicate that it is a ROM failure. Next, the LED displays two numbers which indicate the ROM chip number (01,02,03,...,12). Then there is a pause and the LED display is repeated. Next, another pause occurs and then the CRT displays a "ROM ERROR X" where X indicates the ROM number.
5. If the CRT display shows any RAM or ROM errors, use the above description to identify the faulty chip and then turn power off and replace the chip.
6. If there is no CRT display at power-up:
 - a. Open the upper back door to the game.
 - b. Disengage the latch and open the lower back door.
 - c. Depress the Reset push-button on the CPU/Video board and observe the 7-segment LED display on the ROM board to identify any faulty chip.
 - d. After identifying the chip, remove power to the game and replace the faulty chip.
 - e. As only one chip at a time is indicated by the testing system, repeat steps c & d until there is a CRT display.
7. Extensive CMOS RAM data integrity checks are performed. With "OPEN COIN DOOR" displayed, check that the batteries on the CPU/Video Board are seated in the battery clips, open the coin door, and then turn power OFF and ON. A display of "FACTORY SETTINGS RESTORED" should appear.
8. Depress ADVANCE and turn the power OFF and ON to get to game over.

NOTE:

A detailed explanation of the CMOS RAM data integrity checks and system recovery is provided in appendix A.

GAME OPERATION

* Indicates adjustable features.

GAME START - Insert coins - credits are displayed on CRT. With one credit displayed, pressing 1-Player start initiates a *3-ship game. With two credits displayed, pressing 2-Player Start initiates a 2-player, *3-ship game. With two or more credits displayed, pressing 1-Player Start (or four or more credits, pressing 2-Player Start) initiates a *7 ship game.

Player Controls

UP & DOWN Joy Stick - Maneuvers player ship up and down.

REVERSE Switch - Reverses player ship direction.

THRUST SWITCH - Controls player ship speed.

FIRE SWITCH - Activates laser gun.

HYPERSPACE Switch - Warps player ship to another quadrant with chance of possible annihilation.

SMART BOMB Switch - Destroys all alien ships on screen.

INVISIO Switch - While depressed, the player ship with a shield that renders it invisible and invulnerable.

Game Play

Destroy alien ships and missiles. Rescue humanoids and pick them up to collect bonus. Picking up the first humanoid scores 500 points, the second 1000, the third 1500, and all subsequent score 2000.

Going through the STARGATE warps the player ship to an area where a humanoid requires rescue. Passing through the STARGATE forward while carrying *4 humanoids, warps the player ship to an advanced wave and scores appropriate humanoid bonuses. Going through backwards inhibits the warp.

BOOKKEEPING AND EVALUATION TOTALS

1. In Game Over mode, open the cashbox and depress the cashbox advance switch. The advance switch located on the coin door can also be used. The CRT should indicate all bookkeeping and evaluation totals. If so, go to step 3, if the CRT display comes up in the ROM test display perform step 2.
2. Continue to depress the cashbox advance switch, stepping the game through test programs for ROMs, RAMs, CMOS RAMs, Color RAMs, Sounds, Switches, and then CRT Test Patterns, of which there are five. The fifth test pattern is a color bar pattern and directly precedes the CRT display of the bookkeeping and evaluation totals.
3. The bookkeeping and evaluation totals appear on the display as in Figure 1.

Clearing Bookkeeping Totals

1. Depress ADVANCE to display Game Adjustments, page 1.
2. Hold joystick down to display Game Adjustments, page 2.
3. Operate joystick to position cursor on CLEAR BOOKKEEPING TOTALS.
4. Depress FIRE.
5. Depress ADVANCE.



BOOKKEEPING TOTALS	
LEFT SLOT COINS	4
CENTER SLOT COINS	0
RIGHT SLOT COINS	18
PAID CREDITS	22
EXTRA SHIPS	796
PLAY TIME IN MINUTES	1152
SHIPS PLAYED	2467
TOTAL PLAYS	563
WARPS	90

Figure 1. Bookkeeping Display

GAME ADJUSTMENTS (Figures 2 and 3)

In the Game Over mode open the coin door and depress the coin door advance switch twice to cause a CRT display as shown in Figure 2.

To select and then set functions to the desired values, use the UP-DOWN control lever to select the function that is to be changed and then, making sure the coin door is open, use the THRUST control to reduce, or the FIRE control to increase the value of the selected function. To alternate between adjustments on pages 1 and 2, use the UP-DOWN control.

Extra ships, smart bombs, and inviso time are earned as the score obtained by a player exceeds the listed value for this function. If this function is set to the recommended value of 10,000 points, with a score of 10,000 points a player will receive one more ship to play with. At a score of 20,000 points another ship will be earned, and so on. If this function is set to 0, its lowest setting, no extra ships are ever awarded. This function can be set to any 1,000 point increment from 0 to 50,000 points.

The basic number of ships awarded for a 1 credit game can be set anywhere from 1 to 20. The recommended number of ships for a 1 credit game is 3.

The basic number of ships awarded for a 2 credit game can be set anywhere from 0 (no 2 credit games) to 50. The recommended number of ships for a 2 credit game is 7.

Pricing of the game is selected with standard settings or with custom settings as shown in Tables 1 & 2. Table 1 lists some common pricing schemes with respect to the coin mechanism to be used and directs the reader to the proper entry in Table 2, which shows what the CRT display should look like to accomplish the desired pricing.

For standard settings you need change only the PRICING SELECTION. For custom settings, first set PRICING SELECTION to zero and then set the remaining values according to Table 2.

GAME ADJUSTMENT

EXTRA SHIP EVERY	10000	RECOMMENDED
SHIPS FOR 1 CREDIT GAME	3	RECOMMENDED
SHIPS FOR 2 CREDIT GAME	7	RECOMMENDED
PRICING SELECTION	3	1/QUARTER 4/DOLLAR
LEFT SLOT UNITS	1	
CENTER SLOT UNITS	4	
RIGHT SLOT UNITS	1	
UNITS REQUIRED FOR CREDIT	1	
UNITS REQUIRED FOR BONUS CREDIT	0	
MINIMUM UNITS FOR ANY CREDIT	0	
FREE PLAY	NO	
MORE ADJUSTMENTS		

**USE UP-DOWN LEVER TO SELECT ADJUSTMENT
USE THRUST AND FIRE TO CHANGE THE VALUE**

PRESS ADVANCE TO EXIT

Figure 2. Game Adjustments, Page 1

MASTER DIFFICULTY CONTROL	3	RECOMMENDED
INITIAL DIFFICULTY	5	MODERATE
MAXIMUM DIFFICULTY	15	MODERATE
1ST WAVE OF ACCELERATED DIFFICULTY	0	
LAST WAVE OF ACCELERATED DIFFICULTY	0	
DIFFICULTY ACCELERATION RATE	0	MODERATE
INVISO TIME PER SHIP	10	RECOMMENDED
MEN NEEDED TO WARP	4	RECOMMENDED
LAST WAVE WARP ALLOWED	15	RECOMMENDED
LETTERS FOR HIGHEST SCORE NAME	20	RECOMMENDED
RESTORE FACTORY SETTINGS	NO	
CLEAR BOOKKEEPING TOTALS	NO	
RESET HIGH SCORE TABLE	NO	
AUTO CYCLE	NO	
SET ATTRACT MODE MESSAGE	NO	
SET HIGHEST SCORE NAME	NO	

Figure 3. Game Adjustments, Page 2

Free play can be set to either "YES" or "NO".

The master difficulty control is pre-programmed for 4 levels of difficulty and can be custom programmed for 1 as desired. The recommended setting of the master difficulty control is 3. If customized difficulty is desired, set the master control to 0 and with the use of the UP-DOWN control and THRUST and FIRE controls, set each of the 5 variables as desired.

Initial difficulty is the level of play difficulty for the first attack wave of the game and can be set anywhere between 0 (easy) and 30 (most difficult).

Maximum difficulty is the level of difficulty at which difficulty increases between attack waves cease. This can be set anywhere from 0 (very easy) to 99 (very difficult).

The last three adjustments; first wave of accelerated difficulty, last wave of accelerated difficulty, and difficulty acceleration rate; are all inter-related. The first wave of accelerated difficulty is the point at which the standard difficulty increase rate between attack waves is first stepped up. This can be set to any wave from 1 to 20. The last wave of accelerated difficulty is the point at which the stepped up difficulty increase rate is decreased to the standard difficulty increase rate (exactly the same as it was before it was stepped up). This can be set to any wave from 1 to 99. The difficulty acceleration rate can be adjusted anywhere from 1 to 10. When any of these functions are set to 0, there is no accelerated difficulty.

The amount of "INVISO" time allowed per ship is recommended to be 1 second but can be varied from 0.5 to 2 seconds in tenth-second increments.

The number of men needed to "WARP" a ship anywhere is recommended as 4, but can be varied from 1 to 9. The last wave where any "WARPING" of a ship would be allowed can be set anywhere from 1 to 99, but is recommended as 15.

Table 1. Pricing Schemes

COIN DOOR MECHANISM	CREDITS/MONEY	TABLE 2
		STANDARD SELECTION/ CUSTOM KEY
Twin Quarter Quarter, Dollar, Quarter	1/25¢, 5/\$1	A
	2/50¢, 5/\$1	B
	1/25¢, 4/\$1	3
	2/50¢, 4/\$1	C
	1/50¢, 3/\$1, 4/\$1.25	D
	1/50¢, 3/\$1, 7/\$2	E
	1/50¢, 3/\$1, 6/\$2	1
	1/50¢	5
1DM, 5DM	1/1DM, 6/5DM	2
20-Cent, 50-Cent	1/20¢, 3/50¢	F
1 Franc, 5 Franc	1/2F, 3/5F	4
25 Cent	1/25¢, 4/1G	6
1 Guilder	1/25¢, 5/1G	G
5 Franc	1/5F, 2/10F	7
10 Franc	1/10F	8
1 Franc, 2 Franc	2/1F 5/2F	2
100 Lire, 200 Lire	1/200 Lire	8
Twin Coin	1/1 Coin	3
	1/2 Coins	5
	1/3 Coins, 2 5 Coins	H
1 Unit, 5 Unit	1/2, 3/5	4
	1/1, 5/5	I
	1/3, 2/5	J

Table 2. Pricing Settings

DISPLAY FUNCTIONS	STANDARD SELECTION									CUSTOM KEY										
										A	B	C	D	E	F	G	H	I	J	
Pricing Selection	1	2	3	4	5	6	7	8	9	0	0	0	0	0	0	0	0	0	0	0
Left Slot Units	1	6	1	1	1	1	1	1	1	1	1	1	3	12	6	1	2	1	2	2
Center Slot Units	4	0	4	16	4	0	0	0	4	4	4	4	12	48	0	0	0	0	0	
Right Slot Units	1	1	1	6	1	4	2	2	1	1	1	1	3	12	15	4	2	5	10	
Units per Credit	2	1	1	2	2	1	1	2	1	1	1	1	4	14	5	1	5	1	5	
Units for Bonus Credit	4	0	0	0	0	0	0	0	0	4	4	0	15	96	0	4	0	0	0	
Min Units for Credit	0	0	0	0	0	0	0	0	0	0	2	2	0	24	0	0	0	0	0	

Highest Score Signature

The number of letters allowed the highest scoring player to enter their name can be varied from 3 to 20 and is recommended as 20. If objectionable words are entered as the signature name, you can change the lettered entry leaving the highest score the same. See Setting Highest Score Name.

Restoring Factory Settings

1. Position the cursor on RESTORE FACTORY SETTINGS.
2. Depress FIRE.
3. Depress ADVANCE.

Resetting High Score Table

1. Position the cursor on RESET HIGH SCORE TABLE.
2. Depress FIRE.
3. Depress ADVANCE.

Setting Attract Mode Message

1. Position the cursor on SET ATTRACT MODE MESSAGE.
2. Depress FIRE.
3. Depress ADVANCE.
4. Enter up to two lines of your message following instructions on the screen.
5. Depress ADVANCE to terminate process.

NOTE:

To restore the Williams attract mode message, it is necessary to perform steps 1 through 3 and then turn the game OFF and back ON.

Setting Highest Score Name

1. Position the cursor on SET HIGHEST SCORE NAME
2. Depress FIRE.
3. Depress ADVANCE.
4. Enter new signature, depress ADVANCE to terminate process.

NOTE

An alternate, simpler method enters the factory highest score signature. In the game over mode, hold HIGH SCORE RESET depressed. After a few seconds a sound is produced and the factory highest score signature has been activated.

DIAGNOSTIC PROCEDURES

Diagnostic procedures are controlled by the AUTO-UP/MANUAL-DOWN and ADVANCE switches on the coin door.

ROM Test

Set the AUTO-UP/MANUAL-DOWN switch to the MANUAL-DOWN position and depress the ADVANCE pushbutton. A ROM test is performed and any ROM failure is first indicated on the ROM Board 7-segment LED display and then on the CRT screen as described in the Power-Up and Reset Tests text.

RAM Test

With ROM test results present on the CRT display, depressing the ADVANCE pushbutton initiates the RAM test. If a RAM failure is detected, it is first indicated on the 7-segment LED display on the ROM board and then on the CRT display as described in the Power-Up and Reset Tests text. Test scanning will continue if no failures are detected; depress the ADVANCE pushbutton to terminate the test and the CRT display will indicate that no failures were detected.

CMOS RAM Test

With RAM test results present on the CRT display, depressing the ADVANCE pushbutton initiates the CMOS RAM test. If the test is passed, the 7-segment LED display on the ROM board will read "0" and then the CRT display will read "CMOS RAM TEST PASSED". If a CMOS RAM failure is detected, the 7-segment LED display will read first "3" and then "2", then "3" and then "2", and after these displays the CRT display will read "CMOS RAM FAILURE". In this case the CPU/Video Board needs to be replaced. If an interlock failure is detected, the 7-segment LED display will read first "3" and then "1", the "3" and then "1" and after these displays the CRT display will read "CMOS INTERLOCK FAILURE". If there is an interlock failure detected, first check out all connections to and from the interlock switch including the switch itself and if all of these items check out then replace the CPU/Video Board.

SOUND Test

With the CMOS RAM test completed, depressing the ADVANCE pushbutton initiates the Sound test. At this point the 5 basic sounds of the game are cycled through automatically. Each sound is labeled a "SOUND LINE" by the CRT display. If more than one "SOUND LINE" produces the same sound, check all cable connections to and from the sound board. If all connections check out, replace the sound board and/or the ROM Board and repeat the SOUND test.

SWITCH Test

When the SOUND test has been completed depress the ADVANCE pushbutton to enter the SWITCH test. During this test the CRT displays the name of each switch as it is closed and blank out the name of each switch that is open. The AUTO-UP/MANUAL-DOWN switch is spring loaded to always be in the AUTO-UP position (closed) and therefore will always be printed out on the CRT display. Operate all player panel and coin door switches being sure to operate the ADVANCE pushbutton last, as, when this switch is operated the COLOR RAM test will be entered. If any switch that is operated does not show up on the CRT display, check out all connections to and from the switch for continuity and check the switch contacts for cleanliness. If all cabling and contacts check out, replace the ROM Board for coin switches or the Interface Board for player panel switches and repeat the test.

Color RAM Test

When the SWITCH test has been completed, depress the ADVANCE pushbutton to enter the Color RAM test. At this point the CRT display starts cycling through 8 different colors, dark red, red, light red, dark green, green, light green, dark blue, and blue. If any of these 8 frames have a vertical band through them, this indicates a Color RAM fault. To "clean up" or "get rid of" any vertical bands, replace the CPU/Video board.

Monitor Test Patterns

From the Color RAM test, depressing the ADVANCE pushbutton initiates the MONITOR TEST PATTERNS by placing a form of a CROSS-HATCH pattern on the screen. This pattern can be used to check and adjust the color convergence of the monitor. After the convergence is as desired, depress the ADVANCE pushbutton and the CRT display goes to a red color purity adjustment display. Depress the ADVANCE once more for green purity adjustments and once more for blue purity adjustments. Finally, depress the ADVANCE pushbutton and the CRT display should be a color bar pattern of (from left to right): red, green, blue, black, white, yellow, cyan, and magenta. With the completion of any and all monitor adjustments depressing the ADVANCE pushbutton initiates the transfer to the BOOKKEEPING TOTALS display.

For ease in monitor adjustments, the monitor may be slid back and the screen viewed in a mirror. Remove the two bolts and carefully slide the monitor back in its shelf; secure the monitor in the extended position by inserting the two bolts through holes in the monitor base and monitor shelf provided at the left side of the monitor.

Auto Cycle Mode

1. From the color bar pattern (or from game over with the switch set to AUTO-UP) depress ADVANCE two times to display Game Adjustments page 1.
2. Hold the joystick down to advance to the second page of game adjustments.
3. Position the cursor on AUTO CYCLE with the joystick and depress FIRE.
4. Depress ADVANCE.
5. The system will now sequence through ROM, RAM, and CMOS RAM tests repeatedly. The coin door must be open during Auto Cycle test. If an error is detected, the test is terminated and the failure indication is displayed on the CRT.
6. To terminate the Auto-Cycle test, turn the game OFF and ON.

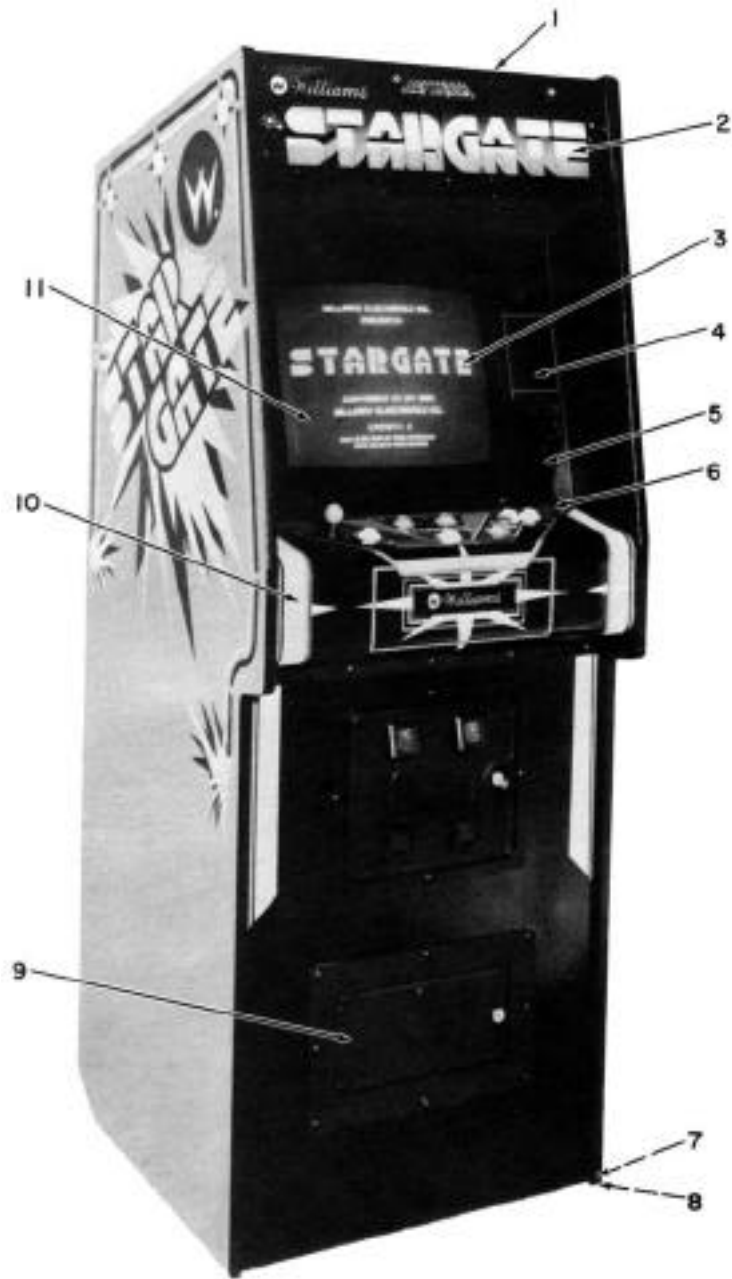

PARTS LIST

ITEM	PART N°.	DESCRIPTION
1	03-7590	Top Cabinet Molding
2	31-1011-3002-U	Marquee Screen Glass
3	03-7594	CRT Bezel
4	16-3002-25	Stargate-U Instructions Card
5	31-1013-3002-U	CRT Screen Cover
6	03-7654	Control Panel Molding
7	08-7025-A	Leg Adjuster
8	08-7025-B	Nut-Leg Adjuster
9	C-8832	Cash box Door Assembly
10	31-1012-3002-U	Screen Control Panel Cover
11	03-7587	Top Glass Molding

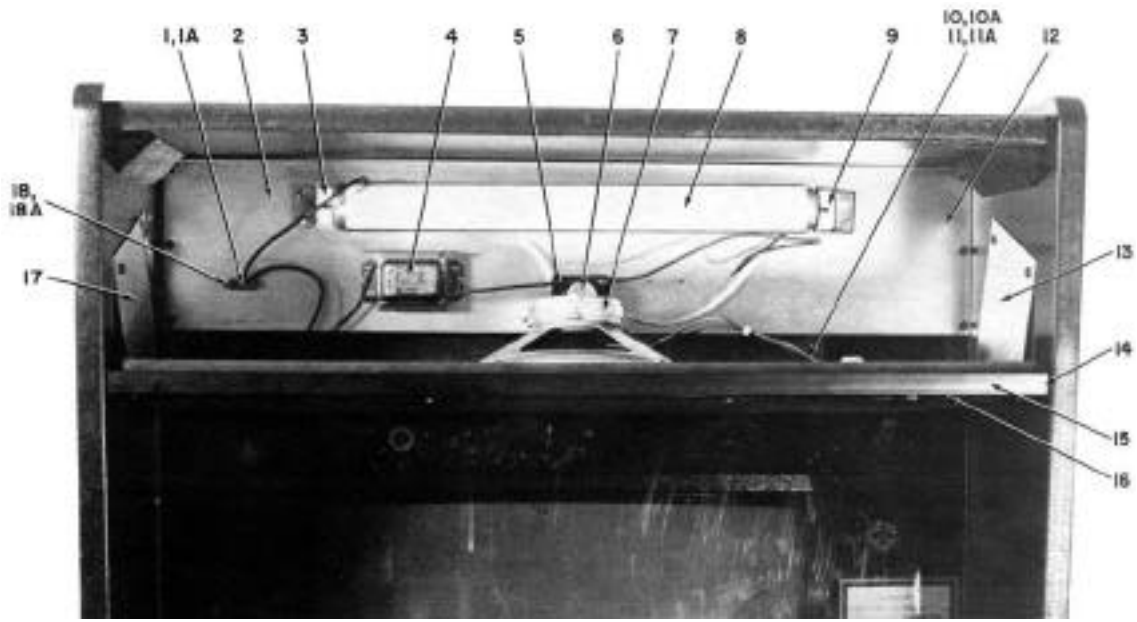

PARTS LIST

ITEM	PART N°.	DESCRIPTION
1	5792-09395	Connector, 3 Pin Female
1A	5821-09079	Connector Pins
2	01-7005	Light Deflector Panel
3	20-8746	Fluorescent Lamp Holder
4	20-8749-8	Fluorescent Lamp Ballast
5	20-8747	Fluorescent Lamp Starter Fixture
6	20-8745-1	Fluorescent Lamp Starter
7	5555-09382	Speaker, 4 Ohm, 6", 3W
8	24-6597-5	Fluorescent Lamp
9	01-3827	Light Mounting Bracket
10	5791-09111	Connector, 3 Pin Male
10A	5821-09080	Connector Pins
11	5792-09395	Connector, 3 Pin Female
11A	5821-09079	Connector Pins
12	D-8374	Light Reflector Assembly
13	01-6997	Right Speaker Panel Bracket
14	D-8833	Speaker Panel Assembly
15	11-618	Speaker Panel
16	03-7650	Speaker Panel Cover
17	01-6996	Left Speaker Panel Bracket
18	5791-09111	Connector, 3 Pin Male
18A	5821-09080	Connector Pins

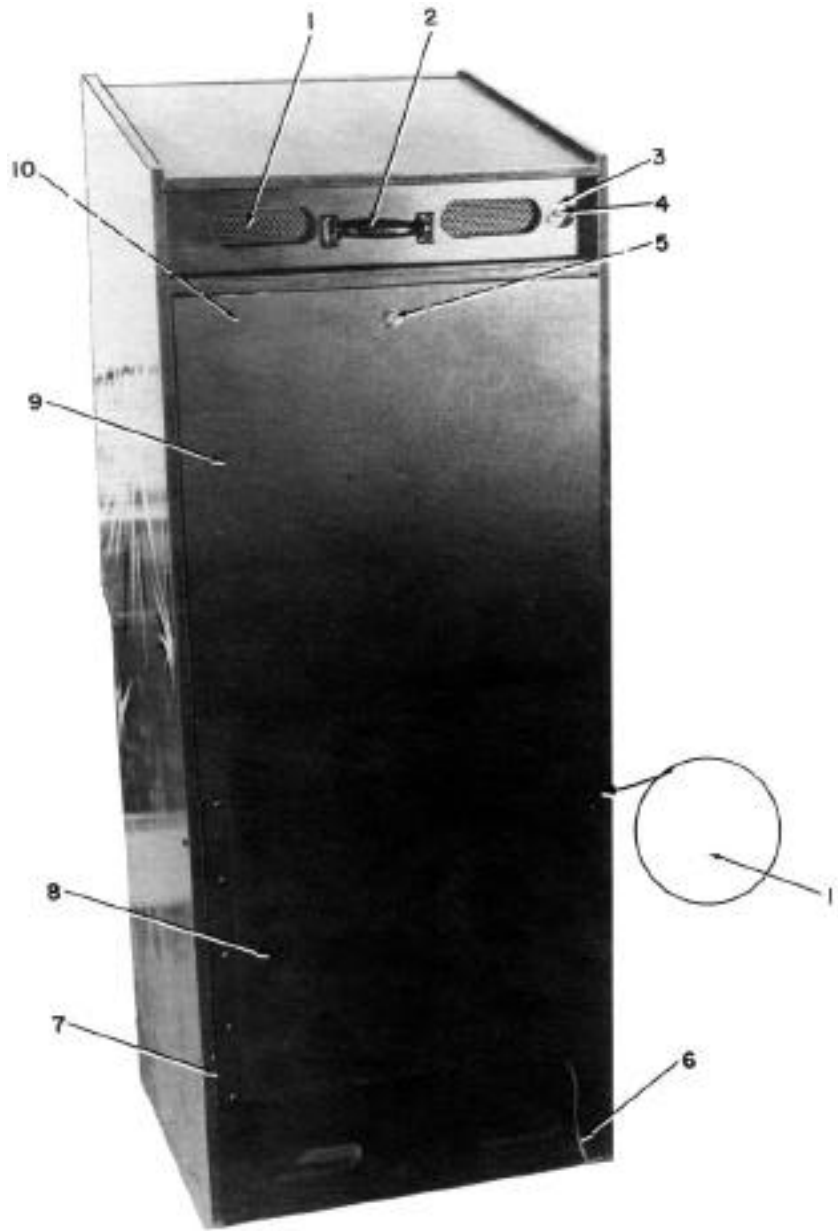

PARTS LIST

ITEM	PART N°.	DESCRIPTION
1	03-7602	Vent Hole Cover
2	20-9267	6-1/2" Handle
3	01-7228	Toggle Switch Mounting Plate
4	5640-06137	Toggle Switch, SPST, 125v 6A or 250v 3A
5	01-7264	Door Lock Retainer
6	5850-08728	Line Cord, 15 Ft.
7	01-7224	Lower Rear Door Hinge
8	11-615	Lower Rear Door
9	C-8932	Upper Rear Door
10	01-7227	Anti-Theft Bar
11	20-9266	Trunk Latch

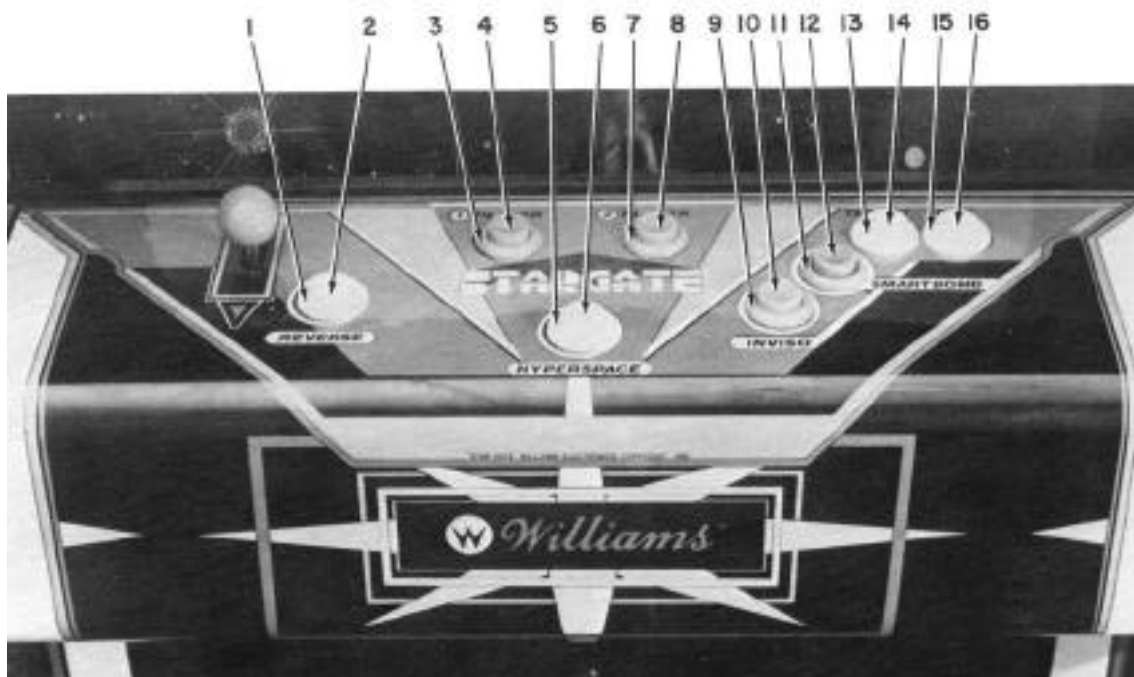

PARTS LIST

ITEM	PART N°.	DESCRIPTION
1	03-7593-4	Flipper Button Body, Red
2	03-7592-4	Flipper Button, Red
3	03-7593-5	Flipper Button Body, White
4	03-7592-5	Flipper Button, White
5	03-7593-4	Flipper Button Body, Red
6	03-7592-4	Flipper Button, Red
7	03-7593-5	Flipper Button Body, White
8	03-7592-5	Flipper Button, White
9	03-7593-4	Flipper Button Body, Red
10	03-7592-4	Flipper Button, Red
11	03-7593-2	Flipper Button Body, Green
12	03-7592-4	Flipper Button, Green
13	03-7593-4	Flipper Button Body, Red
14	03-7592-4	Flipper Button, Red
15	03-7593-4	Flipper Button Body, Red
16	03-7592-4	Flipper Button, Red

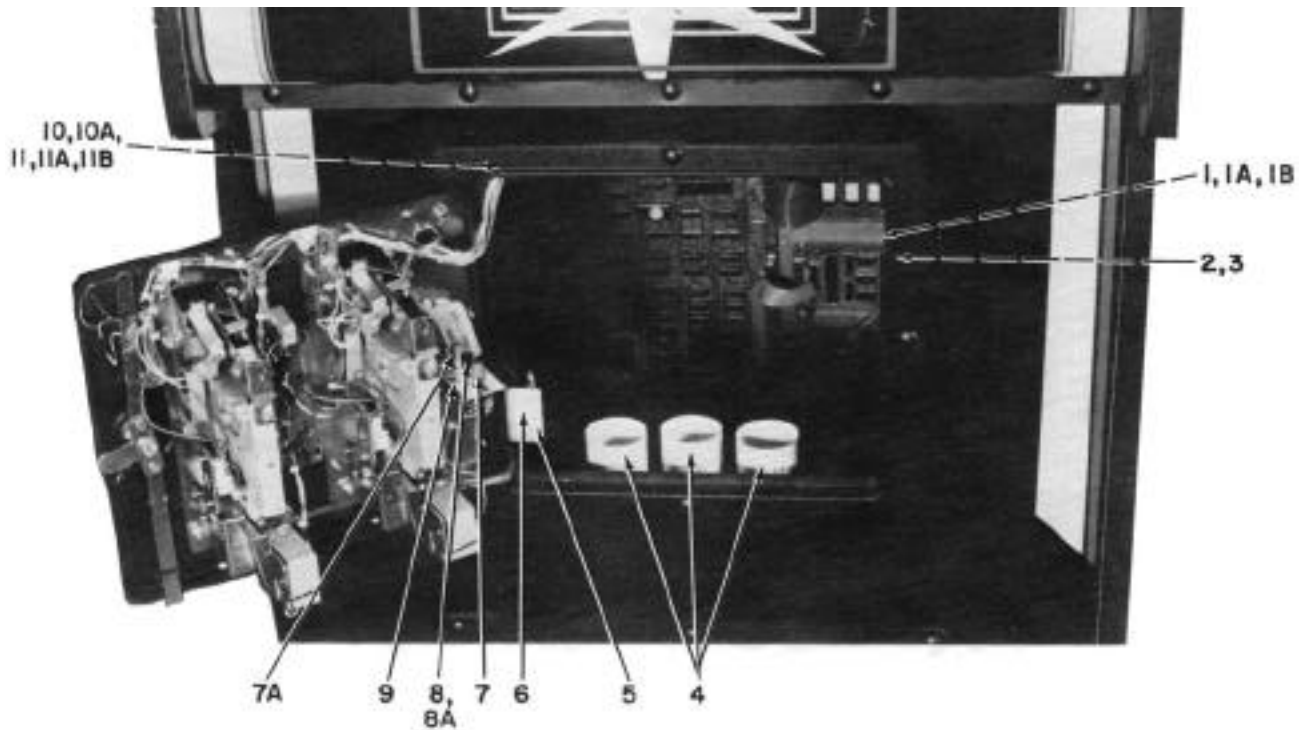

PARTS LIST

ITEM	PART N ^o .	DESCRIPTION
1	5792-09103	Connector, 4 Pin Female
1A	5822-09076	Connector Pins
1B	5823-09082	Polarizing Key
2	01-6858	Volume Control Mounting Bracket
3	5014-09170	Volume Control Potentiometer, 5K, 1W, 10%
4	03-7653	Coin Chute Tube
5	01-5589	Memory Interlock Switch Bracket
6	5643-09268	Memory Interlock Switch, SPST
7	4004-01005-06	Switch, Pushbutton, SPDT
7A	03-7601-4	Switch Button, Red
8	5641-09369	Switch, Pushbutton, DPDT
8A	03-7601-7	Switch Button, Black
9	01-7174	Switch Bracket
10	5791-09093	Connector, 15 Pin Male
10A	5820-09078	Connector Pins
11	5792-09094	Connector, 15 Pin Female
11A	5821-09079	Connector Pins
11B	5823-09360	Polarizing Key

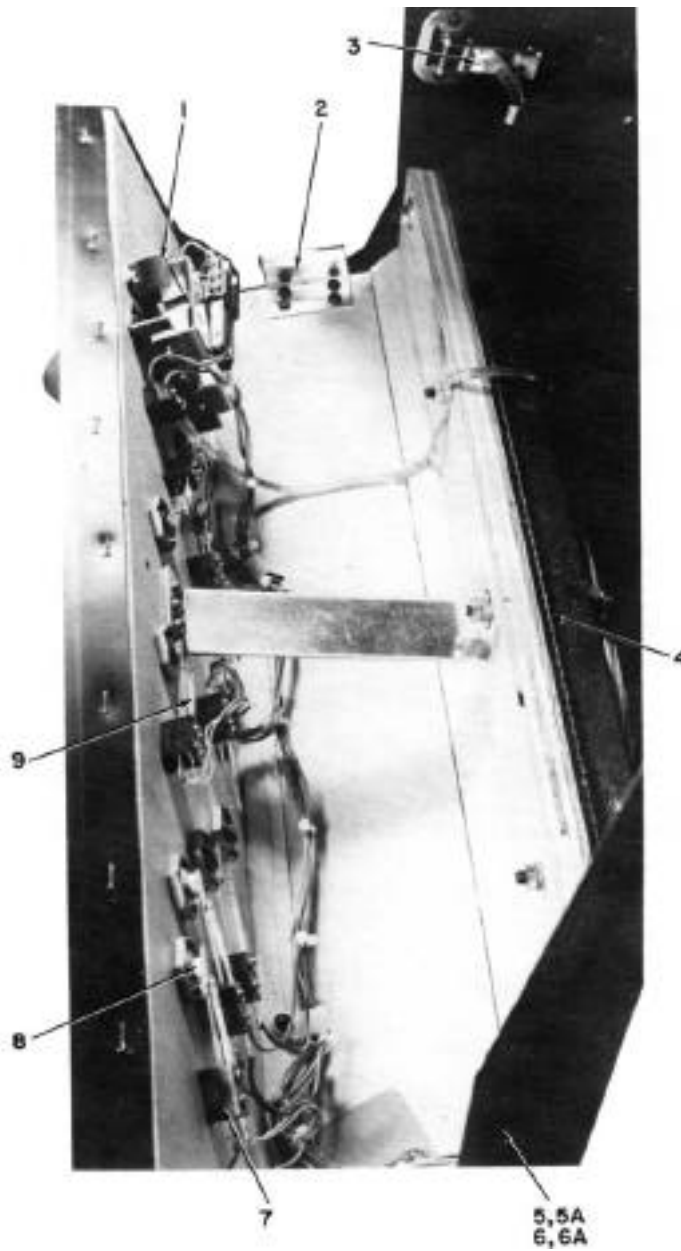

PARTS LIST

ITEM	PART N°.	DESCRIPTION
1	20-9254	Joystick Control
2	01-6994	Trunk Latch Bracket
3	20-9266	Trunk Latch
4	01-7170	Control Panel Hinge
5	5791-09132	Connector, 12 Pin Male
6	5820-09078	Connector Pins
7	5792-09133	Connector, 12 Pin Female
8	5821-09079	Connector Pins
9	03-7614	Molded Universal Switch
10	20-8712-31	"E" Ring, 5/16" Shaft
11	10-366	Reference Spring

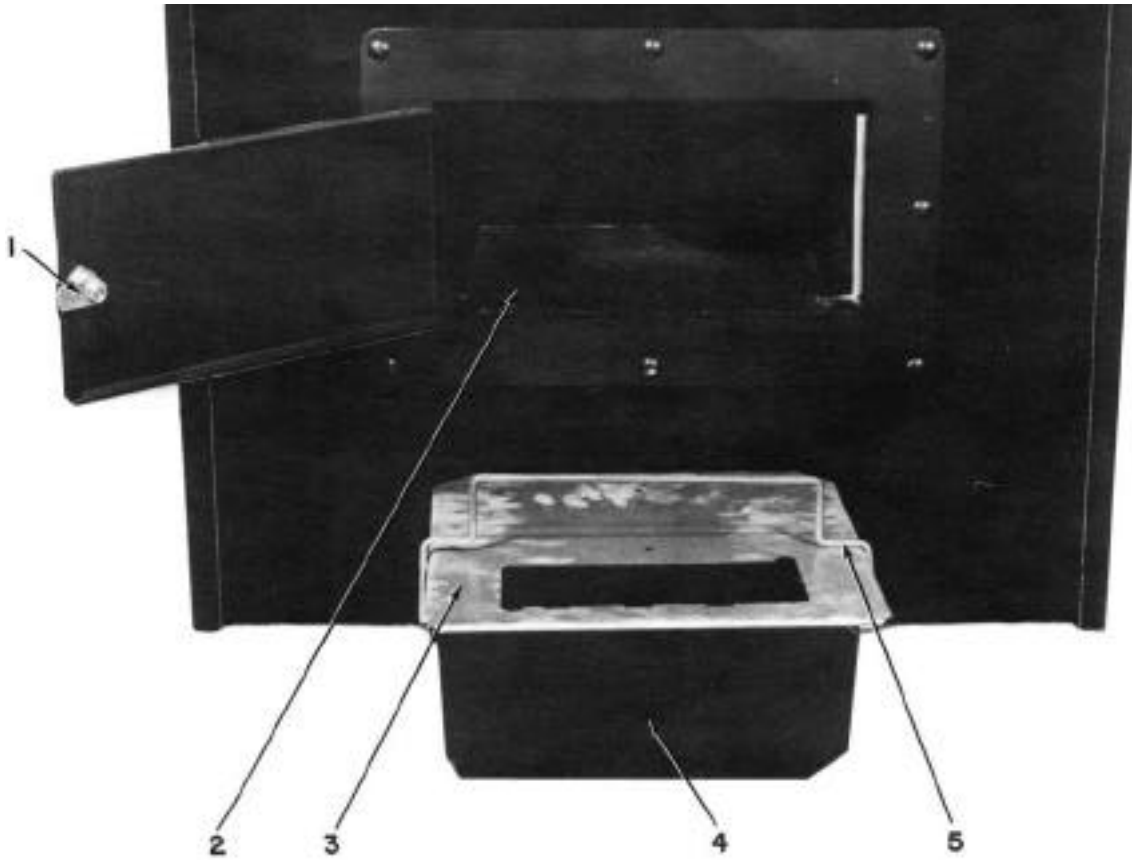

PARTS LIST

ITEM	PART N°	DESCRIPTION
1	01-7200	Lock Striker
2	01-7217	Door Striker
3	01-7220	Cashbox Cover
4	03-7625	Cashbox, Deep
5	12-6589	Cashbox Handle

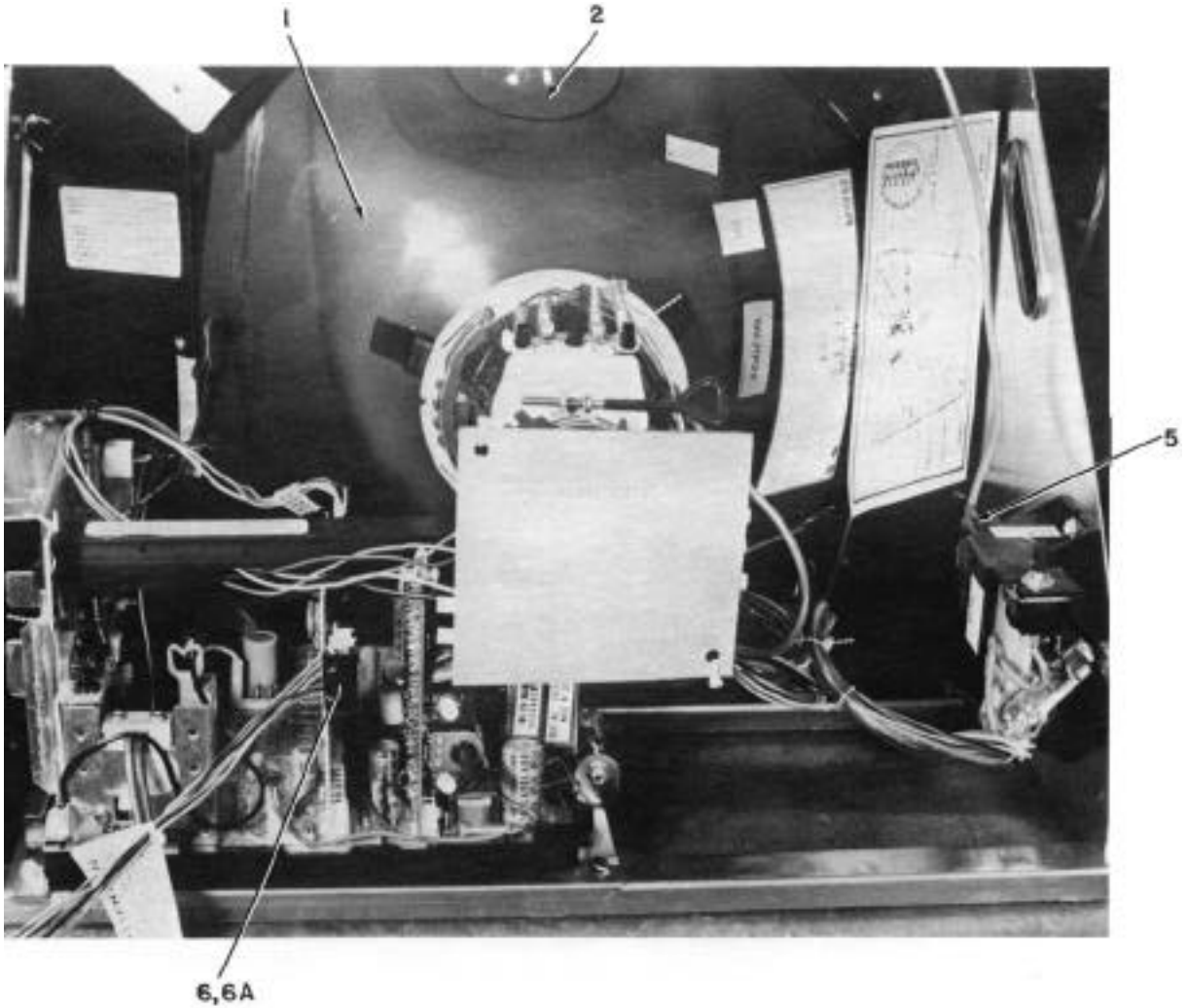

PARTS LIST

ITEM	PART N°.	DESCRIPTION
1	5675-09516	19" Color Monitor
2	03-7655-08	Monitor Harness Clip, 1/2"
3	01-6869	Interlock Switch Bracket (Not Shown)
4	5643-09556	Interlock Cheat Switch (Not Shown)
5	C-8529	Video Transformer Assembly
6	5791-09316	Connector, 6 Pin Male
6A	5820-09080	Connector Pins
7	5792-09454	Connector, 2 Pin Female (Not Shown)
7A	5821-09081	Connector Pins (Not Shown)

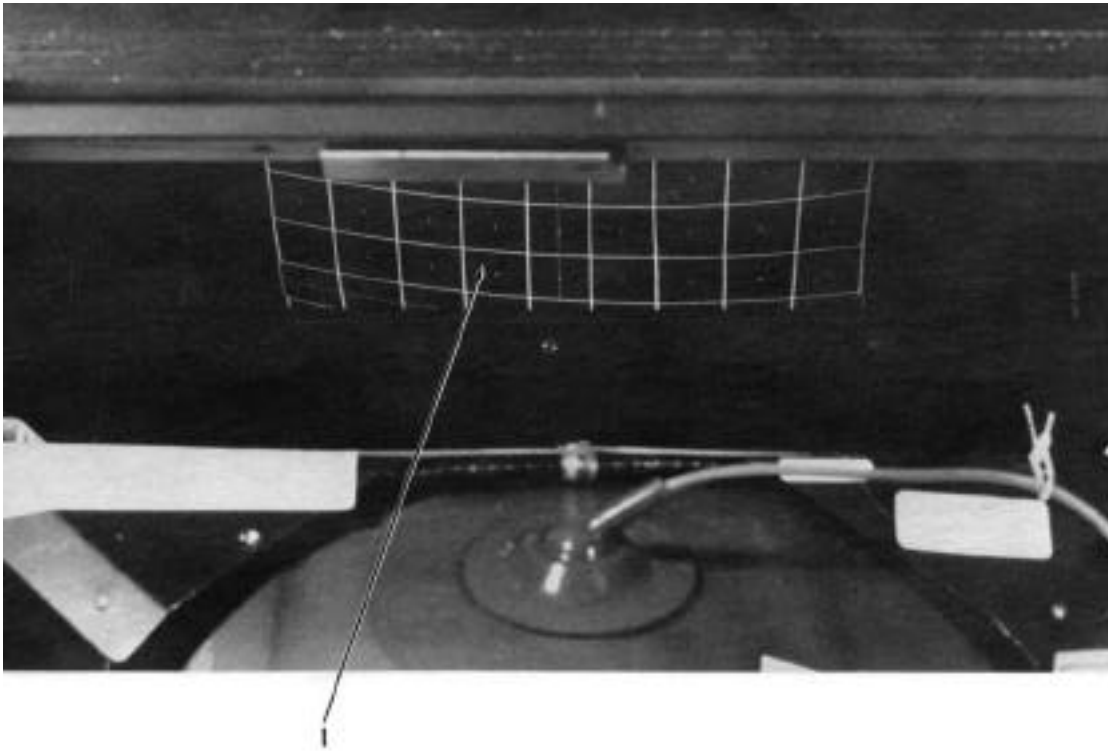

PARTS LIST

ITEM	PART N°.	DESCRIPTION
1	01-7202	CRT Mirror

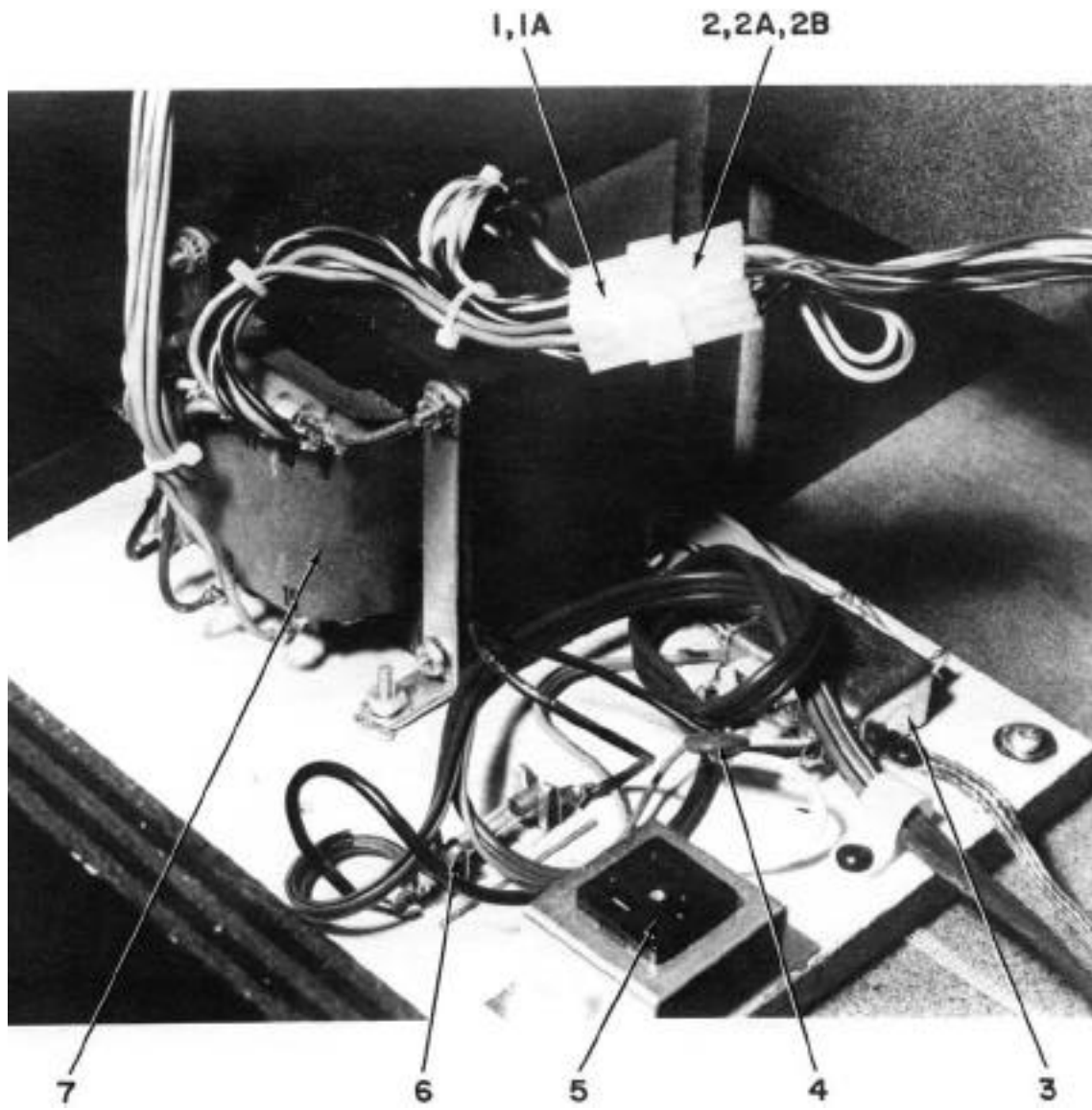

PARTS LIST

ITEM	PART N°.	DESCRIPTION
1	5791-09572	Connector, 12 Pin Male
1A	5820-09080	Connector Pins
2	5792-09106	Connector, 12 Pin Female
2A	5822-09076	Connector Pins
2B	5823-09082	Polarizing Key
3	5102-09696	Line Filter
4	5017-09044	Varistor, 130v
5	5851-09184	Service Outlet
6	5731-08633	Fuse, 3ASB, 115v
7	5610-09535	Transformer, 115/230v AC

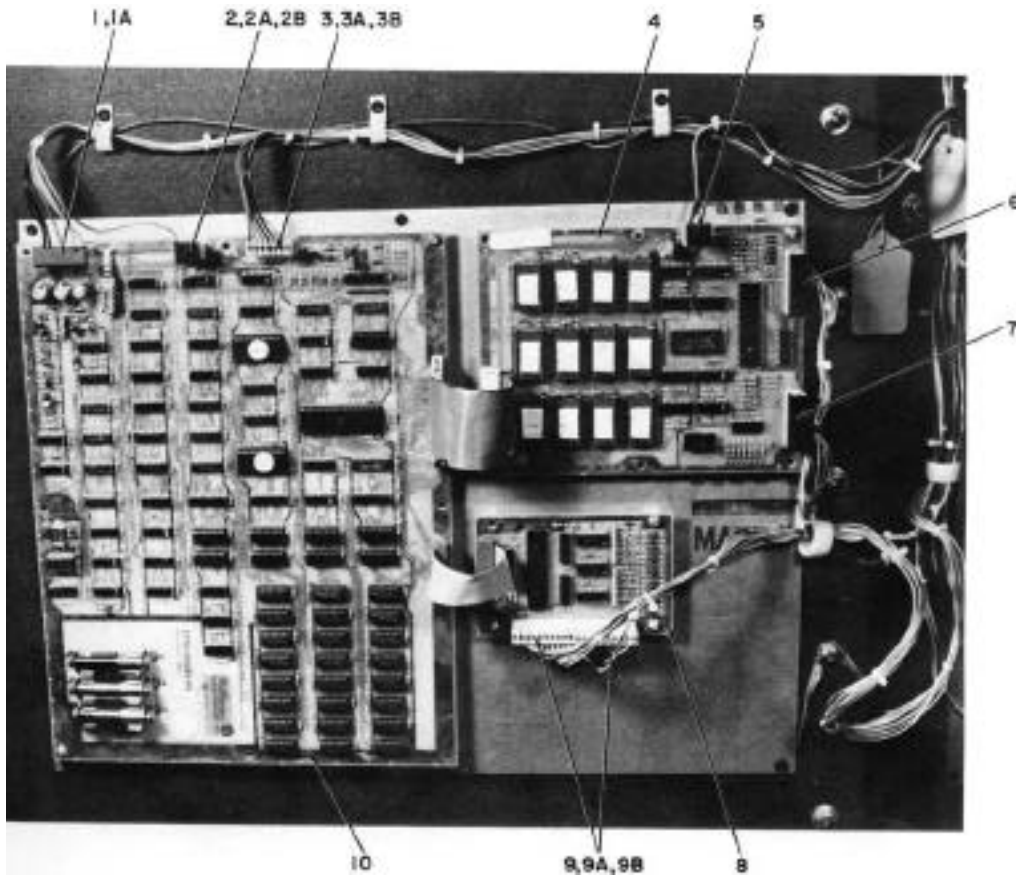

PARTS LIST

ITEM	PART N°.	DESCRIPTION
1	5792-09336	Connector, 9 Pin Female
1A	5821-09081	Connector Pins
2	5792-09288	Connector, 4 Pin Female
2A	5821-09079	Connector Pins
2B	5823-09360	Polarizing Key
3	5792-09496	Connector, 7 Pin Female
3A	5821-09081	Connector Pins
3B	5823-09360	Polarizing Key
4	D-8730	ROM/PIA Assembly
5	5792-09564	Connector, 4 Pin Female
5A	5821-09081	Connector Pins
5B	5823-09360	Polarizing Key
6	5792-09502	Connector, 10 Pin Female
6A	5821-09079	Connector Pins
6B	5823-09360	Polarizing Key
7	5792-09290	Connector, 9 Pin Female
7A	5821-09079	Connector Pins
7B	5823-09360	Polarizing Key
8	C-8783	Widget Assembly
9	5792-09502	Connector, 10 Pin Female
9A	5821-09079	Connector Pins
9B	5823-09360	Polarizing Key
10	R-8731	CPU/Video Assembly
11	01-6994	Trunk Latch Bracket (Not Shown)

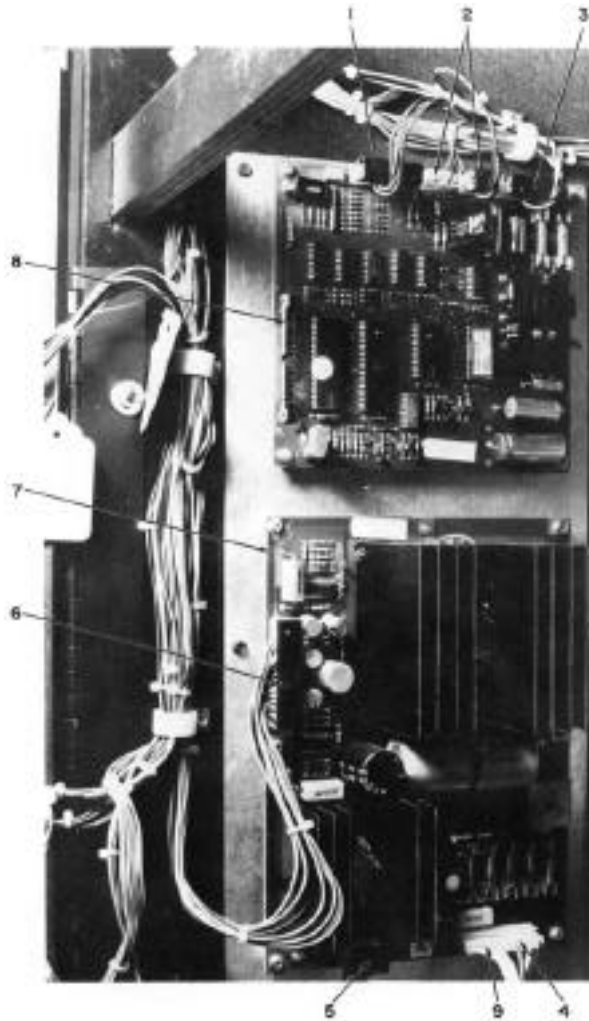

PARTS LIST

ITEM	PART N°.	DESCRIPTION
1	5792-09290	Connector, 9 Pin Female
1A	5821-09079	Connector Pins
1B	5823-09360	Polarizing Key
2	5792-09288	Connector, 4 Pin Female
2A	5821-09079	Connector Pins
2A	5823-09360	Polarizing Key
3	5792-09336	Connector, 9 Pin Female
3A	5821-09081	Connector Pins
4	5792-09109	Connector, 12 Pin Female
4A	5821-09081	Connector Pins
5	5792-09517	Connector, 6 Pin Female
5A	5821-09081	Connector Pins
5B	5823-09360	Polarizing Key
6	5792-09567	Connector, 15 Pin Female
6A	5821-09081	Connector Pins
6B	5823-09360	Polarizing Key
7	D-8359	Power Supply Board Assembly
8	D-8224-3001	Sound Board Assembly
9	C-8733	Over-Voltage PC Board Assembly (Not Shown)

**2800 SERIES COIN DOOR EXPLODED VIEW
25¢ U.S. COIN**

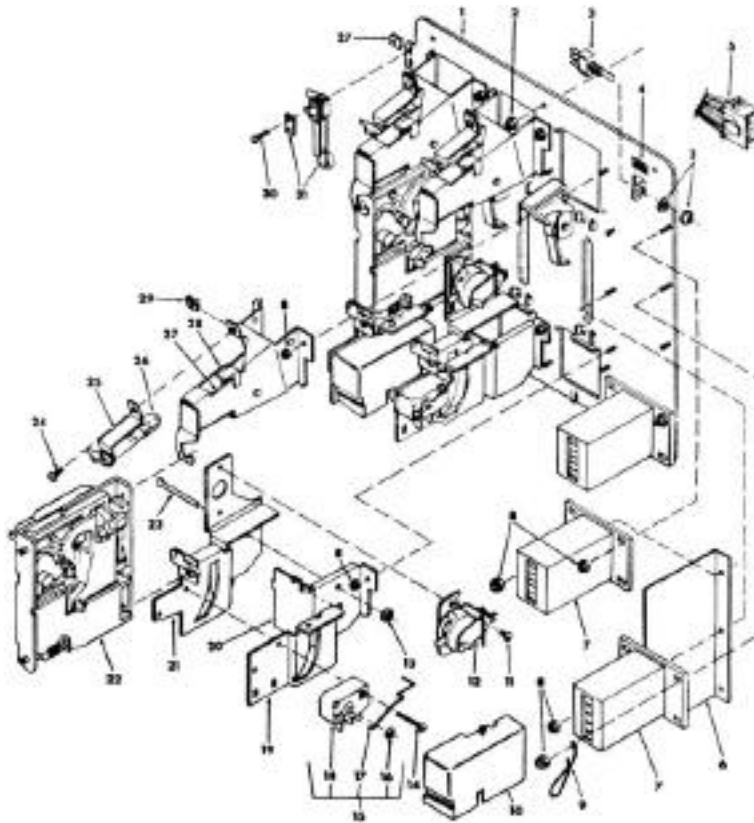

PARTS LIST

Index N°.	Part N°.	Description	Index N°.	Part N°.	Description
1	404429	Inner Panel With Levers Assembly	17	904710-1	Silver Switch Wire (US - 25¢)
2	400-8	Nut	18	904845	Switch
3	904782	Toggle Switch	19	904701	Coin Chute
4	904706	Test Switch Decal	20	904598	Coin Return Box
5		Custom Harness Assembly	21	404428	Switch and C.R.E.M. Coil Bracket
6	904822	Insulation	22	5301-10	25¢ Acceptor
7	404352	Coin Counter Assembly (6v DC)	23	905115	Bar
8	400-4	Nut	24	110-4-6	Screw
9	904722	Wire Key Holder	25	904717	Mini Bayonet-Base Lamp Socket
10	904762	Switch Cover	26	904716	#47 Lamp (6.3v)
11	100-6-3	Screw	27	404418	Coin Inlet Chute Sub-Assembly
12	404354	C.R.E.M. Coil Assembly (12v DC)	28	904594	Right Half of Coin Inlet Chute
13	904936	Keeper	29	904712	"U" Type Fastener
14	100-4-12	Screw	30	116-4-8	Screw
15	404353	Coin Switch Assembly (US - 25¢)	31	904704	Slam Switch Assembly
16	900651	Retainer			



**Coin Acceptors, Inc.
St. Louis, Missouri USA & Toronto, Canada.**

“Warning: This equipment generates, uses, and can radiate radio frequency energy and if not installed and used in accordance with the instructions manual, may cause interference to radio communications. As temporarily permitted by regulation it has not been tested for compliance pursuant to Subpart J of Part 15 of FCC Rules, which are designed to provide reasonable protection against such interference. Operation of this equipment in a residential area is likely to cause interference in which case the user at his own expense will be required to take whatever measures may be required to correct the interference.”

APPENDIX A

CMOS RAM Data Test Protocol

The first sub-test of the CMOS RAM data is that of the ATTRACT MODE MESSAGE checksum. If the test does not pass, the factory ATTRACT MODE MESSAGE is restored. Next, the game adjustments are checked and restored to factory settings if an error is found. If game adjustments are found intact, the high score table is checked for any bad entries. Bad entries are replaced with a score of 4,000 points and no initials. If all entries check, the game returns to the Game Over Mode.

If game adjustments are restored to factory settings, the AUDIT TOTALS are checked. If 5 or more audit digits are other than 0-9 (that is hexadecimal A through F) all audit totals are cleared. This is followed by a check of the high score table and the table is reset to factory settings if errors are found. Finally, game adjustments are rechecked and either OPEN COIN DOOR or FACTORY SETTINGS RESTORED is displayed. With the former, open the coin door and turn the game OFF and ON and then FACTORY SETTINGS RESTORED will be displayed. Return to game over by depressing the ADVANCE pushbutton or by turning the game OFF and ON a second time.

