

# VS.TENNIS™

## (Operation Manual)

### I. How to install Software ROMs

Each Software ROM is labeled with a Location Number shown on it (  Shaded Portion illustrated below), which will indicate the corresponding location on the P.C. Board where it should be installed.



(Label on Software ROM)

The VS Tennis Game contains 12 Software ROMs, which have location numbers, 1A, 1B, 1C, 1D, 2A, 2B, 6A, 6B, 6C, 6D, 8A, and 8B.

Each ROM must be mounted into the proper IC Socket.

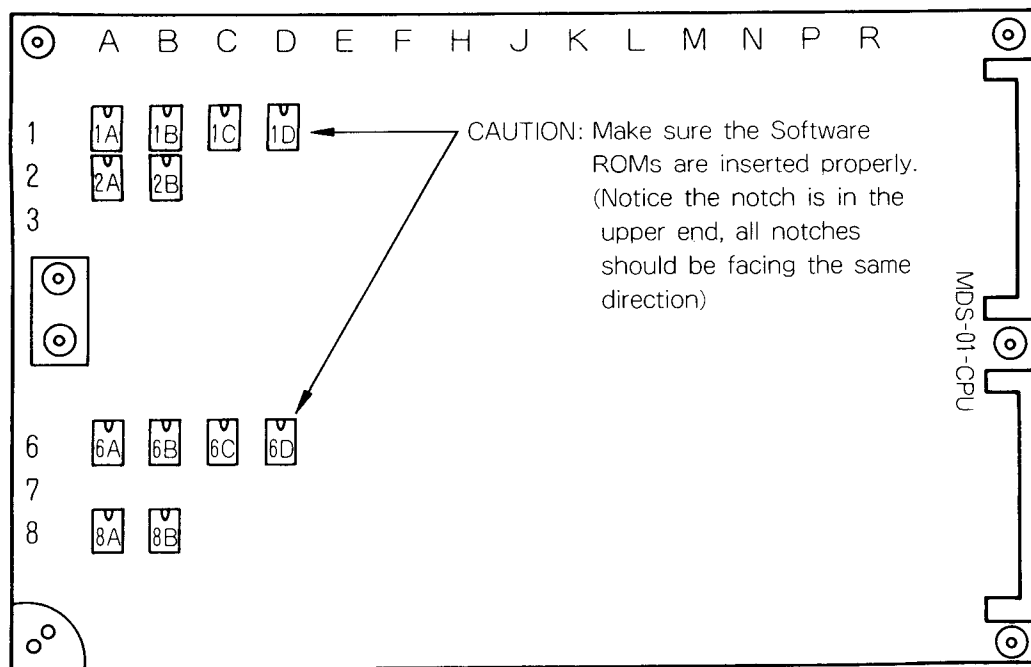

ROM Locations on P.C. Board

Caution: If other Software ROMs are already mounted in the P.C. Board, the new Software ROMs should be mounted after the old software ROMs are removed from the IC Socket.

## 2. Points and methods of adjustment

### MDS P.C. Board

#### Game Option Settings

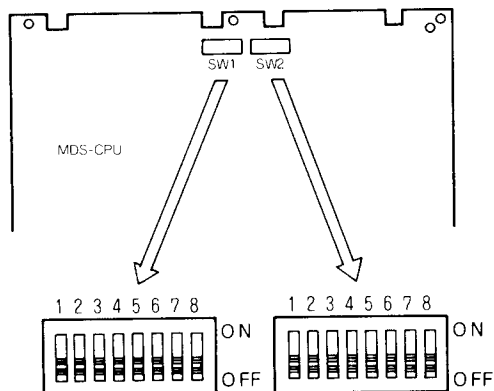

		Switch (SW1) Settings								
			1	2	3	4	5	6	7	8
Difficulty	Easy	1	OFF	OFF						
		2	OFF	ON						
VS. Computer		3	ON	OFF						
	Hard	4	ON	ON						
Difficulty	Easy	1			OFF	OFF				
		2			OFF	ON				
VS. Person		3			ON	OFF				
	Hard	4			ON	ON				
Racket Size	Large							OFF		
	Small							ON		
Extra Score	1 Set								OFF	
	1 Game								ON	
Court Color	Green									OFF
	Blue									ON
NINTENDO	JAPAN									OFF
(TITLE DISPLAY)	USA									ON

		Switch (SW2) Settings								
			1	2	3	4	5	6	7	8
Game Mode		OFF								
Test Mode		ON								
Coin/Credit	1/1		OFF	OFF						
	1/2		OFF	ON						
	2/1		ON	OFF						
	FREE		ON	ON						
Game Mode	A				OFF	OFF				
	Refer to table below				OFF	ON				
	C				ON	OFF				
	D				ON	ON				
Number of Rackets Per Game	3						OFF	OFF		
	4						OFF	ON		
	5						ON	OFF		
	2						ON	ON		
Attract Music	No Music									OFF
	Music									ON

Game Mode	A	B	C	D
Singles (VS · Computer)	1 Credit	1 Credit	1 Credit	1 Credit
Doubles (VS · Computer)	1 Credit	2 Credit	1 Credit	2 Credit
Singles (VS · Person)	2 Credit	2 Credit	2 Credit	2 Credit
Doubles (VS · Persons)	2 Credit	2 Credit	4 Credit	4 Credit

### 3. Test Mode

#### (1) Entering Test Mode

Make sure the main power switch is in "OFF" position.

Set for Test Mode by the switching toggle 1 (SW2) on the game P.C. Board to the "ON" position, and then turn the main power switch to the "ON" position.

#### (2) Memory Test

All ROM and RAM will be tested automatically, and the test result will be displayed on the Video Monitor, with Green meaning "OK", Red meaning "NG", and Yellow meaning "NOT IN IC SOCKET".

Also, the memory back-up condition can be tested, and the result will be displayed on the Video Monitor as a Battery illustration. On power up, "BATT" section will be Red. Turn the power off for 5 seconds, then turn back on. "BATT" section will now be Green if good, and still Red if no good.

Pressing the Service Switch will step to the next test. ("Switch Test")

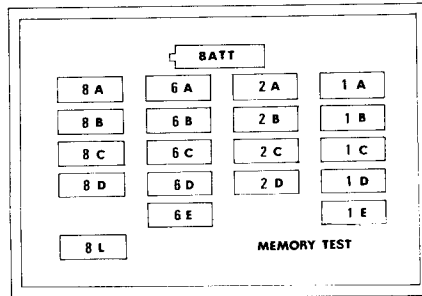

#### (3) Switch Test

All Control Levers, Game Buttons, and Dip Switchs can be tested at this time. The screen should show a picture of the control lever and the game buttons, along with the Dip switch. The picture corresponding to the switch being tested will appear GREEN if in the "OFF" position, and RED if in the "ON" position. Pressing the service switch will step to the next test. (CRT & Sound Test)

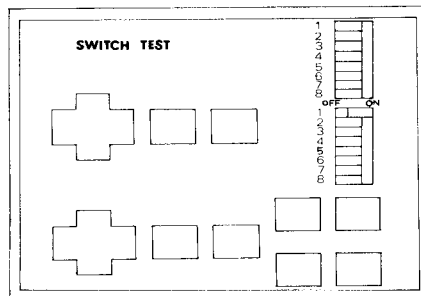

## (4) CRT and Sound Test

### a) CRT Test

The test pattern shown in Fig. 1 will appear on the screen. This pattern is used for adjusting color convergence. Moving a control lever up or down will change the test pattern to an all white screen shown in Fig. 2. This pattern is used for adjusting color purity. (screen should be pure white.) Moving the control lever again will put the first pattern back on the screen, if desired.

### b) Sound Test

The different sound circuits can also be tested at this time. Pressing a "B" button or a "1" or "3" button will start a corresponding sound test. To stop the test, press the "A" button or the "2" or "4" button.

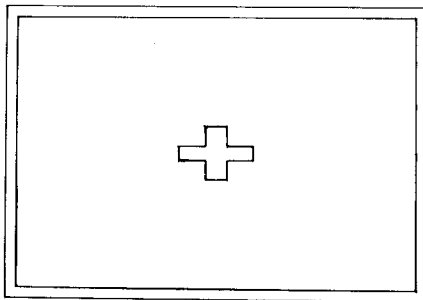

Fig. 1

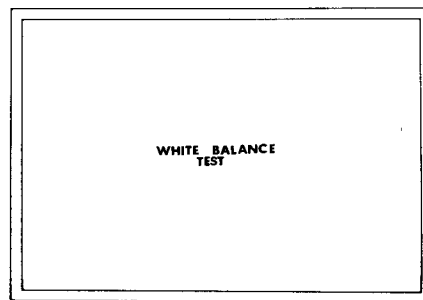

Fig. 2

## (5) Return to Game Mode

Turn the main power switch to "OFF" position. Reset back to "Game Mode" by switching Toggle 1 (SW2) on the P.C. Board, back to the "OFF" position, and then turn the main power switch to the "ON" position.