

1ST PRINTING NOV 00

# SEGA

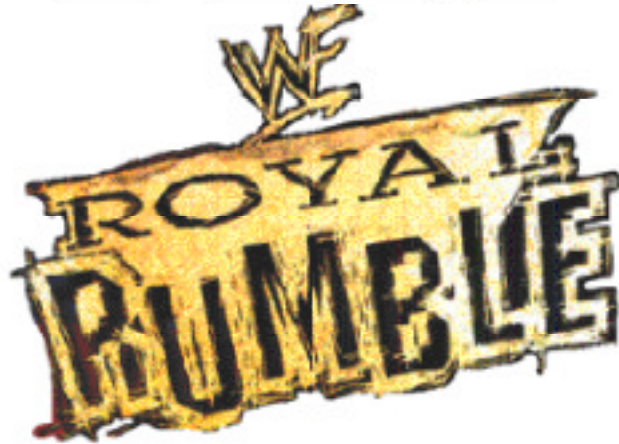

Standard Version

## Owner's Manual



SEGA ENTERPRISES, INC. USA

MANUAL NO. 4201-6609-01

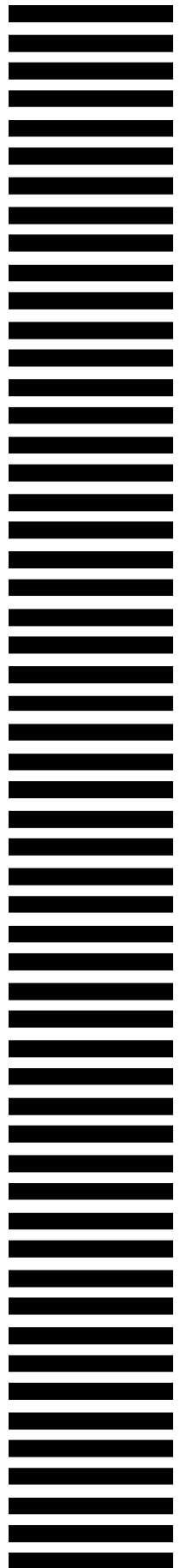

## **Warranty**

Your new Sega Product is covered for a period of 90 days from the date of shipment. This certifies that the Printed Circuit Boards, Power Supplies and Monitor are to be free of defects in workmanship or materials under normal operating conditions. This also certifies that all Interactive Control Assemblies are to be free from defects in workmanship and materials under normal operating conditions. No other product in this machine is hereby covered.

Sellers sole liability in the event a warranted part described above fails shall be, at its option, to replace or repair the defective part during the warranty period. For Warranty claims, contact your Sega Distributor.

Should the Seller determine, by inspection that the product was caused by Accident, Misuse, Neglect, Alteration, Improper Repair, Installation or Testing, the warranty offered will be null and void.

Under no circumstances is the Seller responsible for any loss of profits, loss of use, or other damages.

This shall be the exclusive written Warranty of the original purchaser expressed in lieu of all other warranties expressed or implied. Under no circumstance shall it extend beyond the period of time listed above.

## **BEFORE USING THE PRODUCT, BE SURE TO READ THE FOLLOWING:**

### **To maintain the safety:**

To ensure the safe usage of the product, be sure to read the following before using the product. The following instructions are intended for the users, operators and the personnel in charge of the operation of the product. After carefully reading and sufficiently understanding the warning displays and cautions, handle the product appropriately. Be sure to keep this manual nearby the product or elsewhere convenient for referring to it when necessary.

Herein, explanations which require special attention are enclosed with dual lines. Depending on the potentially hazardous degrees, the terms of WARNING, CAUTION, etc. are used. Be sure to understand the contents of the displays before reading the text.



**WARNING!**

Indicates that mishandling the product by disregarding this warning will cause a potentially hazardous situation which can result in death or serious injury.



**CAUTION!**

Indicates that mishandling the product by disregarding this caution will cause a slight hazardous situation which can result in personal injury and or material damage.

### **For the safe usage of the product, the following pictographs are used:**



Indicates “HANDLE WITH CARE.” In order to protect the human body and equipment, this display is attached to places where the Owner’s Manual and or Service Manual should be referred to.

#### **○ Perform work in accordance with the instructions herein stated.**

Instructions for work are explained by paying attention to the aspect of accident prevention. Failing to perform work as per the instructions can cause accidents. In the case where only those who have technical expertise should perform the work to avoid hazardous situation, the instructions herein state that the serviceman should perform such work.

#### **○ Be sure to turn off power before working on the machine.**

To prevent electric shock, be sure to turn off power before starting the work in which the worker touches the interior of the product. If the work is to be performed in the power-on status, the Instruction Manual herein always states to that effect.

#### **○ Be sure to ground the Earth Terminal** (this, however, is not required in the case where a power cord with earth is used).

This product is equipped with the Earth Terminal. When installing the product, Connect the Earth Terminal to the “accurately grounded indoor earth terminal” by using an earth wire. Unless the product is grounded appropriately, the user can be subject to electric shock. After performing repair, etc. for the Control equipment, ensure that the Earth Wire is firmly connected to the Control equipment.

#### **○ Ensure that the Power Supply used is equipped with an Earth Leakage Breaker.**

This product does not incorporate the Earth Leakage Breaker. Using a power supply which is not equipped with the Earth Leakage Breaker can cause a fire when earth leakage occurs.

#### **○ Be sure to use fuses which meet the specified rating.** (only for the machines which use fuses).

Using fuses exceeding the specified rating can cause a fire and electric shock.

○ **Specification changes (removal of equipment, conversion and addition) not designated by SEGA are not allowed.**

The parts of the product include warning labels for safety, covers for personal protection, etc. It is very hazardous to operate the product by removing parts and or modifying the circuits. Should doors, lids and protective parts be damaged or lost, refrain from operating the product, and contact where the product was purchased from or the office herein stated. SEGA shall not be held responsible for any accidents, compensation for damage to a third party, resulting from the specifications not designated by SEGA.

○ **Ensure that the product meets the requirements of appropriate Electrical Specifications.**

Before installing the product, check for Electrical Specifications. SEGA products have a nameplate on which Electrical Specifications are described. Ensure that the product is compatible with the power supply voltage and frequency requirements of the location. Using any Electrical Specifications different from the designated Specifications can cause a fire and electric shock.

○ **Install and operate the product in places where appropriate lighting is available, allowing warning labels to be clearly read.**

To ensure safety for the customers, labels and printed instructions describing potentially hazardous situation are applied to places where accidents can be caused. Ensure that where the product is operated has sufficient lighting allowing the warnings to be read. If any label is peeled off, apply it again immediately. Please place an order with where the product was purchased from or the office herein stated.

○ **When handling the Monitor, be very careful. (Applies only to the product w/monitor.)**

Some of the monitor (TV) parts are subject to high tension voltage. Even after running off power, some portions are still subject to high tension voltage sometimes. Monitor repair and replacement should be performed only by those technical personnel who have knowledge of electricity and technical expertise.

○ **Be sure to adjust the monitor (projector) properly. (Applies only to the product w/monitor.)**

Do not operate the product leaving on-screen flickering or blurring as it is. Using the product with the monitor not properly adjusted may cause dizziness or a headache to an operator, a player, or the customers.

○ **When transporting or reselling this product, be sure to attach this manual to the product.**

In the case where commercially available monitors and printers are used in this product, only the contents relating to this product are explained herein. Some commercially available equipment has functions and reactions not stated in this manual. Read this manual together with the specific Instruction Manual of such equipment.

- Descriptions herein contained may be subject to improvement changes without notice.
- The contents described herein are fully prepared with due care. However, should any question arise or errors be found, please contact SEGA.

**INSPECTIONS IMMEDIATELY AFTER TRANSPORTING THE PRODUCT TO THE LOCATION.**

Normally, at the time of shipment, SEGA products are in a status allowing for usage immediately after transporting to the location. Nevertheless, an irregular situation may occur during transportation. Before turning on power, check the following points to ensure that the product has been transported in a satisfactory status.

- Are there any dented portions or defects (cuts, etc.) on the external surfaces of the cabinet?
- Are Casters and Adjusters, damaged?
- Do the power supply voltage and frequency requirements meet with those of the location?
- Are all wiring connectors correctly and securely connected? Unless connected in the correct direction, connector connections can not be made accurately. Do not insert connectors forcibly.
- Do power cords have cuts and dents?
- Do the fuses used meet specified rating? Is the Circuit Protector in an energized status?
- Are all accessories available?
- Can all Doors and Lids be opened with the Accessory keys? Can Doors and Lids be firmly closed?

---

---

## TABLE OF CONTENTS

---

---

BEFORE USING THE PRODUCT, BE SURE TO READ THE FOLLOWING:

1. HANDLING PRECAUTIONS .....	2
2. HOW TO PLAY .....	3 - 6
3. TEST MODE .....	7 - 10
A. SYSTEM MENU	
B. GAME TEST MODE	
① INPUT TEST	
Switch input test is performed.	
② GAME ASSIGNMENTS	
Various settings such as game difficulty, etc. can be set.	
③ BOOKKEEPING	
Allows for checking data such as the number of coins inserted, operation time, game time, etc.	
④ BACKUP DATA CLEAR	
Clears the contents of BOOKKEEPING.	
4. GAME BOARD .....	11
5. COIN SELECTOR .....	12 - 13
6. DESIGN RELATED PARTS .....	14 - 15
7. PARTS LIST .....	16 - 19
8. WIRE COLOR CODE TABLE .....	20
9. WIRING DIAGRAM .....	21 - 22

---

---

Use of this product is unlikely to cause physical injuries or damages to property. However, where special attention is required this is indicated by a thick line, the word “IMPORTANT” and its sign in this manual.



IMPORTANT!

Indicates that mishandling the product by disregarding this display can cause the product’s intrinsic performance not to be obtained, resulting in malfunctioning.



IMPORTANT!

- If this is used on the cabinet such as BLAST CITY, MEGALO 410, etc., whose coin chute is used in common with Player 1 and Player 2, be sure to change the setting of COIN CHUTE TYPE from INDIVIDUAL to COMMON in the COIN ASSIGNMENTS. If the game is played on such cabinets with the COIN CHUTE TYPE set to INDIVIDUAL, the game can not be played at Player 2 side. As for COIN ASSIGNMENTS, refer to NAOMI SERVICE MANUAL.
- When power is turned on for the first time, be sure to enter into the TEST MODE to check in the INPUT TEST if INPUT device is satisfactory.

# 1. HANDLING PRECAUTIONS



WARNING!

- To prevent electric shock or IC Board malfunctioning, be sure to turn off the power for the cabinet when installing or removing the IC Board.
- Extraneous matter such as dust on the IC Board can cause the IC Board to generate heat and result in a fire due to short circuit, etc. Ensure the IC Board surfaces are always kept clean.
- Use NAOMI for the cabinets compatible with JVS. Using NAOMI for the cabinet other than those compatible with JVS can cause generation of heat and a fire.



IMPORTANT!

- Be sure to connect the IC Board and connectors completely. Insufficient insertion can damage IC Board, etc.
- For the IC Board circuit inspection, only the use of Logic Tester is permitted. The use of ordinary testers is not permitted as these can damage the IC Board.
- Do not subject the IC Board to static electricity when installing the IC Board in the cabinet or when connecting wire harness connectors to the IC Board.
- When soldering buttons, etc. to the wire harnesses, be sure to remove the wire harnesses from the IC Board so as not to subject the IC Board to heat.
- Using NAOMI without the Shield Case can cause electric wave trouble. Be sure to use NAOMI together with the accessory Shield Case.
- The monitor frequency corresponding to NAOMI is 15 kHz or 31 kHz. NAOMI can not be used for the cabinet incorporating a monitor or projector not corresponding to 15 kHz or 31 kHz.

- Concerning the display of JAMMA VIDEO STANDARD:  
JAMMA VIDEO STANDARD adopted by NAOMI is referred to as JVS. As against this Standard, the conventional JAMMA STANDARD which employs 56P Edge Connectors adopted by ST-V, etc. is displayed as Old JAMMA STANDARD.

The specific Manual attached to each game sometimes displays JVS as JV STANDARD, New JAMMA STANDARD, or JAMMA 2 STANDARD AGAINST OLD JAMMA STANDARD as JAMMA STANDARD, JS, etc.

- The contents herein described are subject to change without notice.

## 2. HOW TO PLAY

### ON-SCREEN DISPLAY

Monitor Position



Synchronous Frequency  
15/31 kHz

### CONTROL PANEL

Moving of Wrestlers

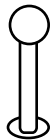

Attack Button



Grapple Button



Support Button



Attack Button	Enables a wrestler to punch and kick an opponent.
Grapple Button	Enables a wrestler to grapple an opponent. Also enables a wrestler to throw, or swing onto the ropes, an opponent after grappling.
Support Button	Enables a wrestler to take an action other than attacking and grappling; that is, to run, mount to a corner, guard, and block.

### Available Playing Modes

Two playing modes are available.

#### Exhibition Mode

This enables you to play a 10-game tournament. You choose a wrestler as yourself and a partner wrestler, and specify the attacks allowed for the partner; thus you may use your own vital techniques as well as the various partner attacks in the game. Additional wrestler (from the CPU) may unexpectedly burst into the ring or you may happen to move to a variety of stages; thus several game effects are prepared.

Maximum 4 wrestlers can play simultaneously. In this case all the wrestlers other than yourself (as a wrestler) may be opponents; you may attack one of them together with the rest of them; or any one of the supporting wrestlers may suddenly betray you. Thus you can enjoy a heated and thrilling game.

#### Royal Ramble Mode

This enables you to join in a battle royal of maximum 9 persons on the ring. Maximum 4 wrestlers can play. Any wrestlers fallen from the ring is disqualified. The bottom center part of the monitor screen shows the number of persons to clear; new wrestlers will continue to appear on the ring until the number becomes 0 (zero). The number counts down only if the playing wrestlers make the CPU wrestler fallen from the ring. Winning wrestlers are those who still remain on the ring when the number is 0 (zero). Furthermore, the high-level S wrestlers may burst into the ring when the number of persons to clear approaches to 0 (zero).

## Basic Operations

### **Attack Button**

This button enables you to punch and kick an opponent. Press the button repeatedly to attack without a break.

### **Grapple Button**

This button enables you to grapple an opponent and then make him staggered or groggy, throw him or swing him onto the ropes. The button also enables you to throw down or squeeze a downed opponent. Furthermore, the button enables you to pick up a weapon on the stage other than the ring.

### **Support Button**

This button enables you to run into the directions set by the lever; and then you may use the attack and/or grapple buttons to battle. If you are nearby the corner, you may set the lever into the direction of the post, press the button to mount to the corner, and use the attack and/or grapple button to battle. Also, you may hold down the button to guard yourself against an opponent's offences. In addition, you may press the button in a timely manner against an opponent's offence thereby to counterattack. Finally the button enables you to pinfall a downed opponent.

### ◆ **Button Operations after Grappling**

#### **Pressing the Attack Button after Grappling**

This action enables you to make an opponent groggy (defenseless). This action, if taken while setting the lever into any desired direction, enables you to make an opponent staggered (also, defenseless) into the set direction. Press the attack button again to punch or kick the groggy or staggered opponent while the grapple button to throw. In these cases, the opponent cannot counterattack.

#### **Pressing the Grapple Button after Grappling**

This action, if taken while setting the lever into any of the neutral/upper/lower/left/right directions, enables you to throw a grappled opponent even if grappled in the rear.

#### **Pressing the Support Button after Grappling**

This action enables you to swing or hammer-throw an opponent onto the ropes. After swinging, press the attack or grapple button to battle. Alternately set the lever into any desired directions to swing the opponent into the set direction. Set it into a slant direction to swing the opponent to the corner in the set direction and thus make the opponent corner-down. Grapple, and then punch, kick, or throw the corner-downed opponent.

NOTE: When grappled you can counterattack by pressing the button same as the one opponent is pressing.



### ■ **Partner Attacks (in Exhibition Mode)**

According to a WWF rule, you specify your own wrestler and its partner. Attacks by the partner are called partner attacks. You also specify any one out of the three partner attacks; Type A, Type B, and Type C. You can use a partner attack by pressing any two buttons simultaneously.

#### **Independent Partner Attacks**

Only a partner wrestler attacks an opponent. These attacks include a dashing punch/kick, continuous attack, weapon attack, dived attack from a corner, and vital technique.

#### **Two-Platoon Attacks**

You (as a wrestler) may try to grapple (or punch or kick) an opponent. After successfully grappling, you and the partner cooperate to do the two-platoon attacks.

#### **Supporting Partner Attacks**

The partner does not attack but provides various supporting actions. Such actions include giving of a weapon, increasing of your special gauge number, decreasing of an opponent's special gauge number, making an opponent groggy, escaping from a pitfall, etc.

NOTE: The Partner Attack are not usable in a wire-netting stage.

### ■ **“S” Special Gauge Icon**

Special gauge icon is located below a power gauge icon and indicates a “S” number. Saving and increasing of the “S” number enables you to use high-grade (HG) attacks, vital techniques, etc. You can use these features by pressing the three buttons simultaneously.

#### **HG Attacks (decreasing of “S” number: 1 each)**

HG attack is more powerful than a usual one. Such powerful attacks include a dashing attack, attack from a corner, downward attack, etc. and thus are usable in various situations.

#### **Vital Technique (decreasing of “S” number: 3 each)**

Every wrestler is given one vital technique (and two lock techniques). Applicable situation of these techniques varies from wrestler to wrestler. One technique is only applicable in a standing position, another for a downed opponent, and the other from a corner. Each vital technique can seriously damage an opponent and even KO a powerless opponent.

#### **Escaping from a Pinch (decreasing of “S” number: 1 each)**

You can escape from a pinch such as a pinfall, groggy state, downed state, grappled state, etc.

## ■ Special Operations with Royal Ramble Mode

The royal ramble mode has a rule of making an opponent fallen from the ring. This needs to specify special operations that an exhibition mode does not support.

### How to make an opponent fallen from the ring

#### ◆ To grapple an opponent nearby the ropes and hammer-throw him into outside the ring:

Grapple an opponent nearby the ropes, set the lever into outside the ring, and press the support button.

NOTE: In an exhibition mode this is to hammer-throw into inside the ring.

#### ◆ To make an opponent stagger into outside the ring:

Grapple an opponent nearby the ropes, set the lever into outside the ring, and press the attack button.

NOTE: In an exhibition mode this is to make an opponent bound against the ropes and stagger.

#### ◆ To punch or kick an opponent leaning against the ropes:

If attacked nearby the ropes, an opponent may lean against them and be in a downed state. Punch or kick such an opponent and then you can make him fallen from the ring.

#### ◆ To raise up and stagger a downed opponent:

Press the grapple button for a downed opponent to raise up and stagger. You can stagger him into any desired directions; if you set the lever into the direction outside the ring, therefore, you can make him fallen from the ring.

### ◇ NOTE:

An opponent having the power may grasp the ropes and thus resist against falling. If this is the case, press the attack button to stonk the opponent. Grasping the ropes to resist against falling for a prolonged time and loosing the power will result in falling from the ring. Get back to the ring by operating the lever. Also, you can return to the ring immediately when pressing the three buttons simultaneously with decreasing “S” number by 1.

## ■ Referee Knockout

You can attack a referee only with a weapon. State of the Referee Knocked Out occurs when you have knocked out the referee twice. In this state the partner attacks can be repeated without a break while usually they can be repeated only with a break. Also in this state you are not counted down even in a pinfall.

## ■ Win and Loss Rule (in Exhibition Mode)

### Pinfall

Press the support button for a downed opponent, which starts counting for a pinfall. Alternately, throw down an opponent and press the support button, which also starts counting for a pinfall. In either case you will be a winner if the opponent is counted out to 3. The pinned wrestler may cancel a pinfall by operating the lever. (Turn the lever for an easier cancellation.) Also, you can quickly cancel a pinfall by pressing the three buttons simultaneously with decreasing “S” number by 1.

### KO

Exercise a vital technique for a low-power opponent to reduce its power to zero. Then you will be a winner.

### Judgment

When the game is ended in a tie, a winner is decided by judging the remaining power etc.

### 3. TEST MODE

#### A. SYSTEM MENU



- When you have changed the settings of the SYSTEM ASSIGNMENTS, COIN ASSIGNMENTS, and GAME ASSIGNMENTS (on the GAME TEST MODE screen), be sure to select the EXIT from the SYSTEM MENU screen and press the test button to exit from a test mode. This action can store the new settings in the IC on the board. Disconnecting the power when in a test mode may fail to store the new settings and eventually the present settings may remain effective.
- This game allows you to set the number of players to 2 or 4. Correctly set it according to the number of the input cables connected to the cabinet. Failure to do so may malfunction the game.

This test mode mainly allows the IC Board to be checked for accurate functioning, monitor color to be adjusted as well as COIN ASSIGNMENTS and GAME ASSIGNMENTS to be adjusted.

1) After turning power on, press the TEST Button to have the following SYSTEM MENU displayed.

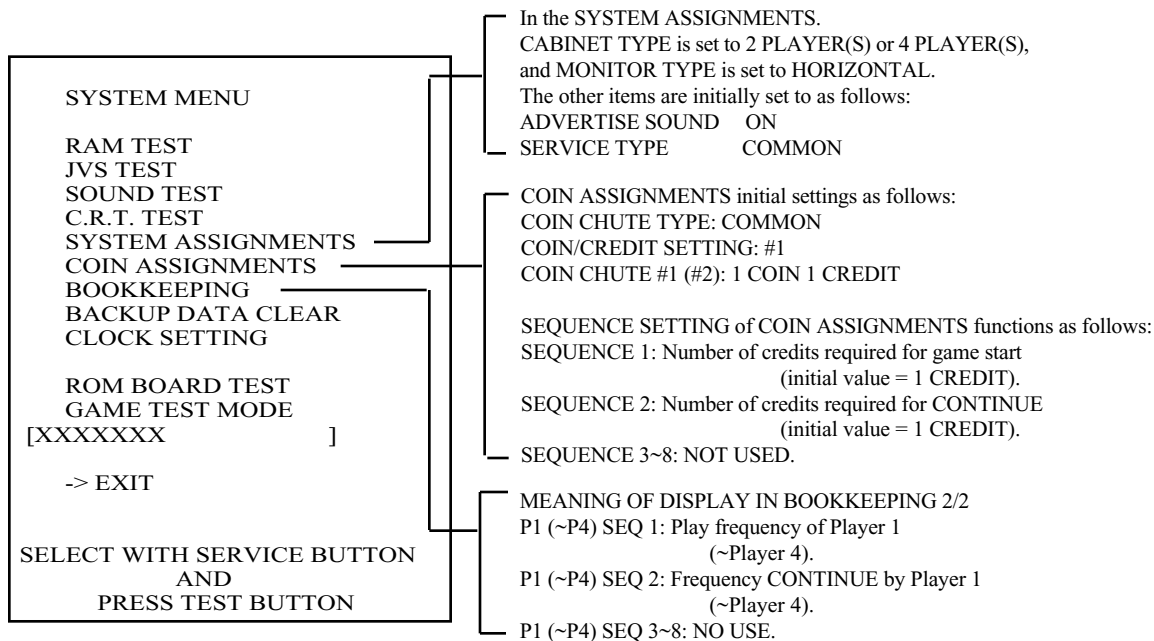

**CAUTION FOR SETTING**

When you have set the SERVICE TYPE and the COIN CHUTE TYPE to INDIVIDUAL, the players 1 and 2 share the credit of COIN 1 and SERVICE 1 while the players 3 and 4 share the credit of COIN 3 and SERVICE 3.

If you want to use the coin chute for COIN 2 (4) and the service button for SERVICE 2 (4), therefore, set the SERVICE TYPE and the COIN CHUTE TYPE to COMMON.

- 2) Press the SERVICE Button to move the arrow. Bring the arrow to the desired item and press the TEST Button.
- 3) Press the TEST Button in the GAME TEST MDOE to display the GAME TEST MODE peculiar to this game. See the next page onward.
- 4) Upon finishing the test, bring the arrow to EXIT and press the TEST Button to return to the Game mode.

For detailed explanations as regards the SYSTEM TEST MODE, refer to NAOMI SERVICE MANUAL (420-6455-01).

## B. GAME TEST MODE

Move the -> mark to GAME TEST MODE item on the SYSTEM MENU screen, and press the TEST Button. The game-specific GAME TEST MODE screen appears.

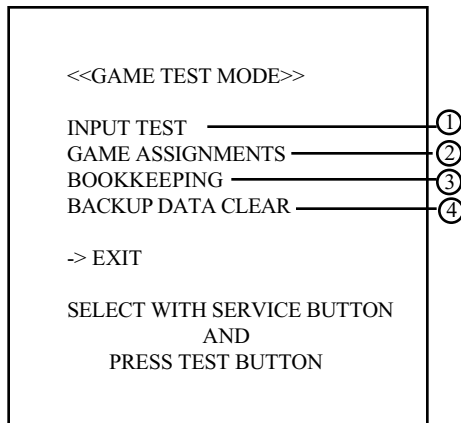

GAME TEST MODE screen

Pressing the SERVICE Button can move the -> mark. Move the -> mark to a desired item, and press the TEST Button.

After testing, select the EXIT and press the TEST Button. The SYSTEM MENU screen reappears.

## ① INPUT TEST

This screen tests the input devices.

```

<<INPUT TEST>>

TEST BUTTON      [OFF]
SERVICE BUTTON  [OFF]

                1P      2P
START            [OFF]  [OFF]
ATTACK          [OFF]  [OFF]
GRAPPLE         [OFF]  [OFF]
SUPPORT         [OFF]  [OFF]
STICK           [0][0][0] [0][0][0]
                [0] [0]  [0] [0]
                [0][0][0] [0][0][0]

PRESS SERVICE BUTTON
AND
TEST BUTTON TO EXIT
    
```

Press each button and make sure that the corresponding OFF disappears and the ON appears.

TEST ..... Changes to ON when pressing the TEST BUTTON.

SERVICE ..... Changes to ON when pressing the SERVICE BUTTON.

START ..... Changes to ON when pressing the START BUTTON.

ATTACK ..... Changes to ON when pressing the ATTACK BUTTON.

GRAPPLE ..... Changes to ON when pressing the GRAPPLE BUTTON.

SUPPORT ..... Changes to ON when pressing the SUPPORT BUTTON.

LEVER ..... From 0 to 1 on the set direction.

0 0 0	If set to the upper	0 0 1
0 0 0	<u>right direction.</u>	0 0 0
0 0 0		0 0 0

If the CABINET TYPE is set to 4 PLAYER(S) on the SYSTEM ASSIGNMENTS screen, the 3P and 4P columns, are displayed.

## ② GAME ASSIGNMENTS

This screen sets the difficulty level and playing time. Press the SERVICE Button to move to a desired item, and press the TEST Button to select a new setting.

```

<< GAME ASSIGNMENTS >>

DIFFICULTY      [NORMAL]
TIME LIMIT      [180]
RESET

EXIT

SELECT WITH SERVICE BUTTON
AND
PRESS TEST BUTTON
    
```

DIFFICULTY ..... 5 levels are selectable.

TIME LIMIT ..... Playing time in minute for a game. 60, 120, or 180 is selectable.

RESET ..... Initial settings are recovered.

Initial settings are:

DIFFICULTY ..... NORMAL

TIME LIMIT ..... 180

### ③ BOOKKEEPING

This screen displays the playing time data.

```
<< BOOKKEEPING >> PAGE 1/2

PLAY TIME          - D - H - M - S
AVERAGE TIME      - M - S
LONGEST TIME       - M - S
SHORTEST TIME     - M - S

PRESS TEST BUTTON TO CONTINUE
```

PLAY TIME ..... Actual playing time data (For 2P game, playing time periods are not overlapped.)

Press the TEST Button to open the next PAGE 2/2 screen.

```
<< BOOKKEEPING >> PAGE 2/2

0M00S ~ 0M29S -
0M30S ~ 0M59S -
1M00S ~ 1M29S -
1M30S ~ 1M59S -
2M00S ~ 2M29S -
2M30S ~ 2M59S -
3M00S ~ 3M29S -
3M30S ~ 3M59S -
4M00S ~ 4M29S -
4M30S ~ 4M59S -
5M00S ~ 5M29S -
5M30S ~ 5M59S -
6M00S ~ 6M29S -
6M30S ~ 6M59S -
7M00S ~ 7M29S -
7M30S ~ 7M59S -
8M00S ~ 8M29S -
8M30S ~ 8M59S -
9M00S ~ 9M29S -
9M30S ~ 9M59S -
OVER 10M00S -

PRESS TEST BUTTON TO EXIT
```

This screen indicates the by-playtime play frequency.

Press the TEST Button to return to the GAME TEST MODE screen.

### ④ BACKUP DATA CLEAR

```
<< BACKUP DATA CLEAR >>

      YES (CLEAR)
      -> NO (CANCEL)

SELECT WITH SERVICE BUTTON
AND PRESS TEST BUTTON
```

This screen clears the high scores and the bookkeeping data.

Press the SERVICE Button to move the -> mark to YES item, and press the TEST Button. When the system completes clearing, the COMPLETED message appears on the screen. Press the TEST Button to return to the GAME TEST MODE screen. Press the SERVICE Button to move the -> mark to NO item, and press the TEST Button. The system does not execute clearing, but returns to the GAME TEST MODE screen.

## 4. GAME BOARD



- Do not expose the Game Board so as to avoid causing an accident or malfunctioning.
- Static electricity discharge can damage electronic parts on the IC Board. Before starting work by opening the Shield Case Lid, be sure to touch grounded metallic surfaces to discharge physically charged static electricity.
- When replacing the Game Board, refer to the CVT Manual and Instruction Manual.

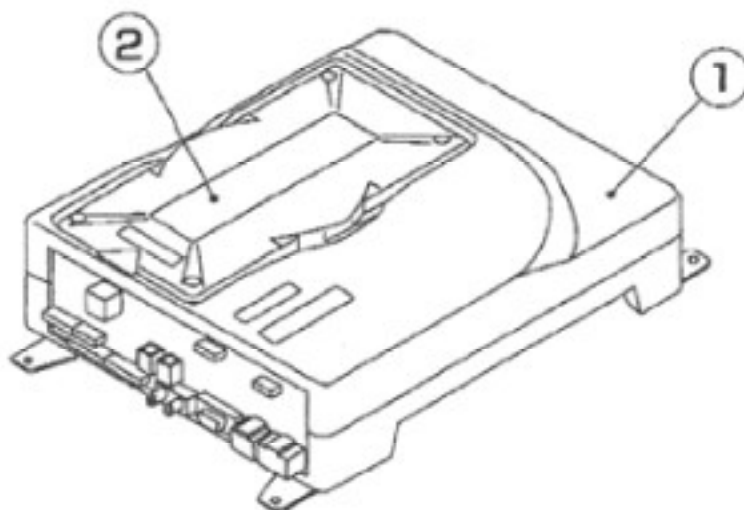

	PART NO.	DESCRIPTION
ASSY CASE (① + ②)	840-0040D-01 840-0040D-02 840-0040D-03 840-0040D-04	ASSY CASE NAO WR1 USA : USA ASSY CASE NAO WR1 EXP : OTHERS ASSY CASE NAO WR1 KOR : KOREA ASSY CASE NAO WR1 AUS : AUSTRALIA
① ASSY CASE NAOMI MAIN BOARD	840-0001A-01 840-0001A-02 840-0001A-03 840-0001A-04	ASSY CASE NAOMI MAIN BD USA : USA ASSY CASE NAOMI MAIN BD EXP : OTHERS ASSY CASE NAOMI MAIN BD KOR : KOREA ASSY CASE NAOMI MAIN BD AUS : AUSTRALIA
② ROM CASE	840-0040C	ROM CASE NAO WR1

## 5. COIN SELECTOR

### HANDLING THE COIN JAM

If the coin is not rejected when the REJECT BUTTON is pressed, open the coin chute door and open the selector gate. After removing the jammed coin, put a normal coin in and check to see that the selector correctly functions.

### CLEANING THE COIN SELECTOR

The coin selector should be cleaned once every 3 months. When cleaning, follow the procedure below:

- ① Turn the power for the machine OFF. Open the coin chute door.
- ② Open the gate and dust off by using a soft brush (made of wool, etc.).
- ③ Remove and clean smears by using a soft cloth dipped in water or diluted chemical detergent and then squeezed dry.
- ④ Remove the CRADLE.  
When removing the retaining ring(E-ring), be very careful so as not to bend the shaft.
- ⑤ Remove stain from the shaft and pillow portions by wiping off with a soft cloth, etc.
- ⑥ After wiping as per #5 above, further apply a dry cloth, etc. to cause the coin selector to dry completely.

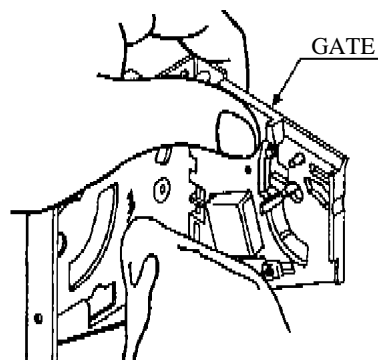

FIG. 5a

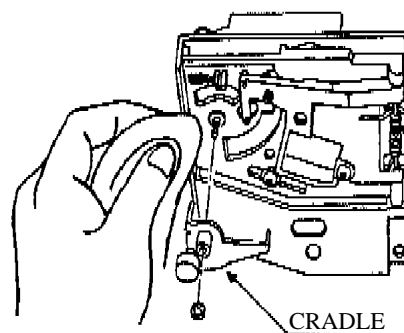

FIG.5b



IMPORTANT!

- Never apply machine oil, etc. to the coin selector
- After cleaning the Coin Selector, Insert a regular coin during the normal working status and ensure that the Selector functions correctly.

### COIN INSERTION TEST

Once a month, when performing the COIN SW TEST, simultaneously check the following:

- Does the Coin Meter count satisfactorily?
- Does the coin drop into the Cashbox correctly?
- Is the coin rejected when inserted while keeping the REJECT BUTTON is pressed down?

Insert a coin while keeping the Reject Button pressed down and check if it is rejected.

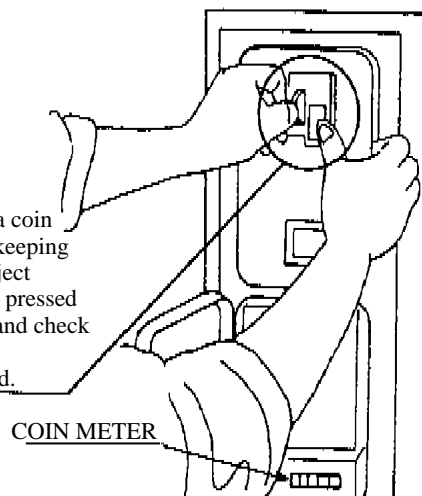

FIG. 5c



## OPTIONAL DOLLAR BILL ACCEPTOR

- THE COIN DOOR ASSEMBLY USED ON WWF ROYAL RUMBLE MINI DX COMES EQUIPPED TO ACCEPT A DOLLAR BILL ACCEPTOR. ALL NEEDED WIRING CONNECTIONS ARE CONVIENENTLY LOCATED INSIDE THE GAME FOR THIS APPLICATION.
- THE COIN DOOR CAN ACCCOMMODATE THE FOLLOWING VALIDATOR(S):

FORWARD-MOST  
HOLE POSITION

Mars 2000 series

\*\*42-1155-00 MARS VALIDATOR \$1, 2, 5 300 CAP

The frame and cashbox enclosure on this coindoor has been modified to accomodate a Mars 2000 series upstacker. A 2000 series stacker can be added by simply removing the cut-out plate. This one entry door can be ordered through Happ Controls or one of Happ Controls authorized distributors. The part number is 40-6000-10EX. The Mars stacker can be obtained through an authorized Mars distributor.

Note: Your game may have either Happ Controls Coin Door Assembly or the Wells Gardner Coin Door Assembly (not shown).

\*\*Happ part number

NOTE: Your game is equipped with a Wells Gardner coin door assembly Model #WGD802105-2608.

Security Locking Bar/Bracket Set Part No.# 999-1102

6. DESIGN RELATED PARTS

(D-1/2)

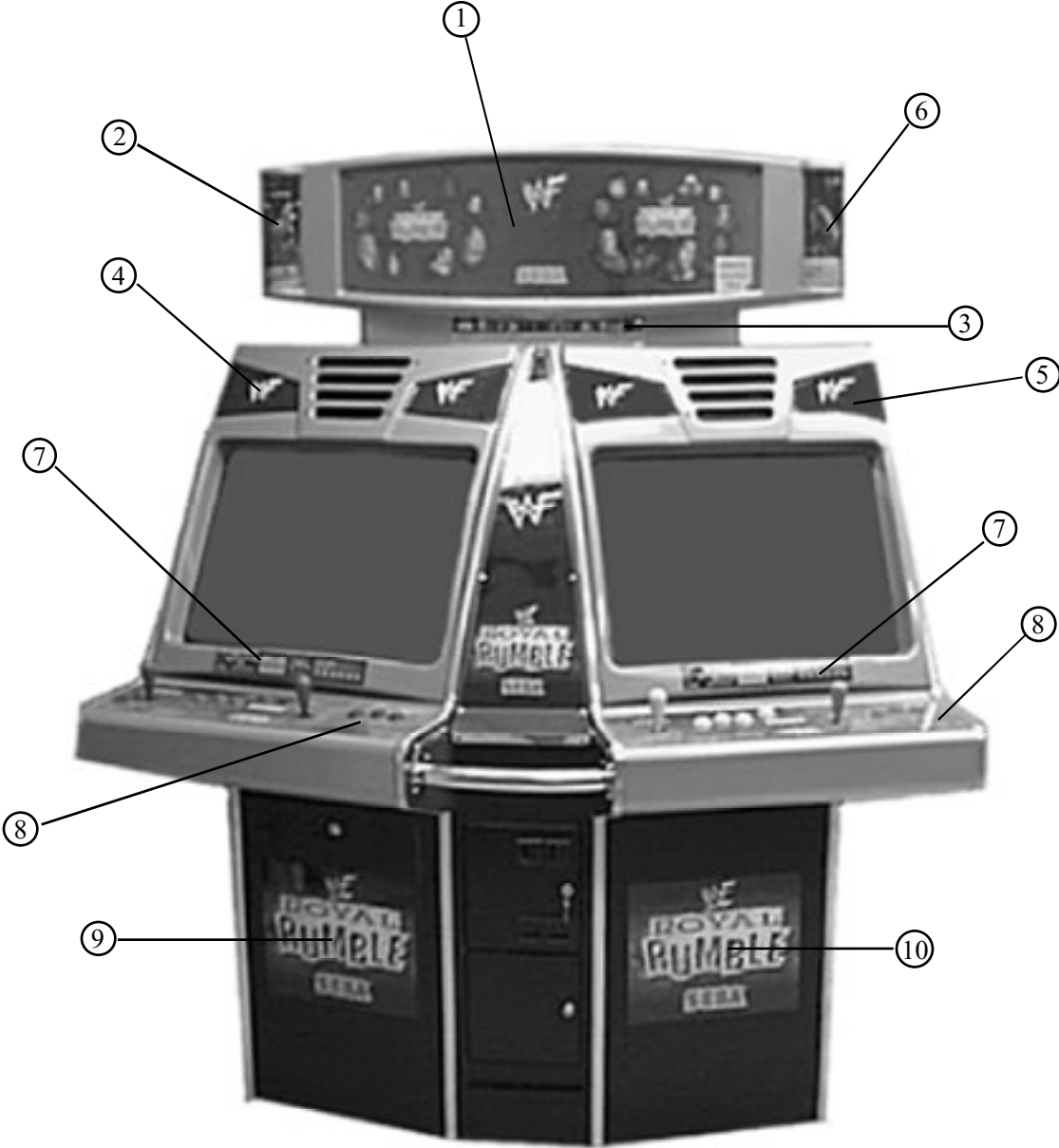

## 6. DESIGN RELATED PARTS

(D-2/2)

ITEM NO.	PART NO.	DESCRIPTION
1	999-1094	MARQUEE PLATE BILLBOARD
2	999-1113	MARQUEE END CAP DECAL LEFT
3	999-1098	INSTR #2 PLAYER INSTR. - SELECT WRESTLER - BELOW BILLBOARD
4	999-1090	DECAL BEZEL LEFT (2 PER)
5	999-1091	DECAL BEZEL RIGHT (2 PER)
6	999-1115	MARQUEE END CAP DECAL RIGHT
7	999-1101	INSTR. #1 MAIN - MOVEMENT INS. (2 PER) - BOTTOM OF EACH MONITOR BEZEL
8	999-1095	CONTROL PANEL ART
9	999-1096	DECAL FRONT DOOR LEFT
10	999-1097	DECAL FRONT DOOR RIGHT
NOT SHOWN	999-1100	DECAL SIDE CABINET UPPER RS
NOT SHOWN	999-1099	DECAL SIDE CABINET UPPER LS

# 7. PARTS LIST

① TOP ASSY

(D-1/2)

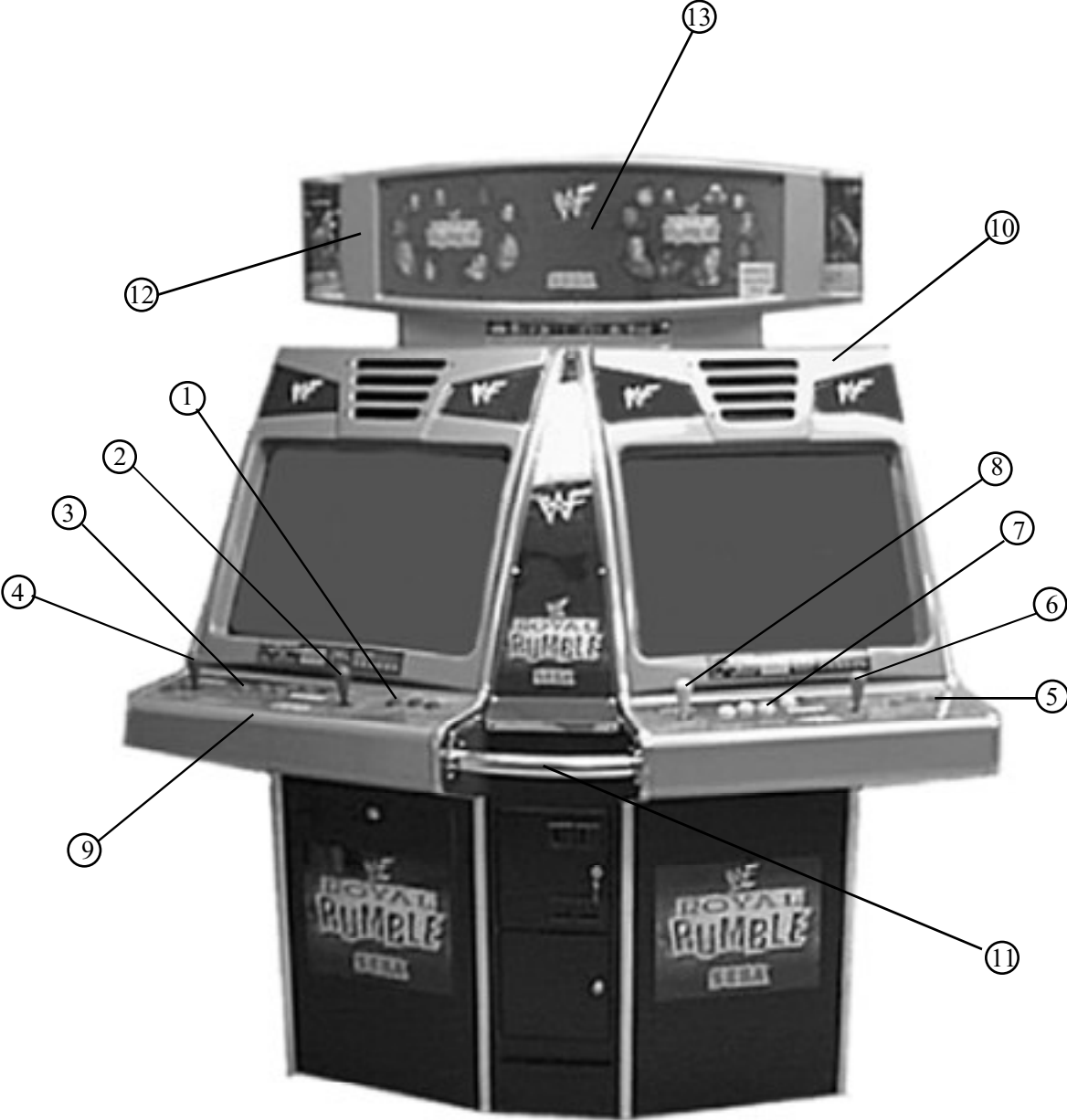

① TOP ASSY

(D-2/2)

ITEM NO.	PART NO.	DESCRIPTION
1	999-1088	PUSHBUTTON ROUND RED 53-9200-13 (4 PER)
2	999-1109	JOYSTICK HAPP RED #50-7608-10
3	999-1089	PUSHBUTTON ROUND BLUE 53-9200-12 (4 PER)
4	999-1110	JOYSTICK HAPP BLUE #50-7608-12
5	999-1086	PUSHBUTTON ROUND GRN. 53-9200-13 (4 PER)
6	999-1111	JOYSTICK HAPP GRN. #50-7608-13
7	999-1087	PUSHBUTTON ROUND YEL. 53-9200-15 (4 PER)
8	999-1112	JOYSTICK HAPP YEL. #50-7608-15
9	999-1095	OVERLAY - CONTROL PANEL
10	999-1092	MONITOR BEZEL GOLD (2 PER)
11	999-1116	HANDLE PIPE CHROME
12	999-1114	MARQUEE BEZEL GOLD
13	LOC. PURCHASE	36" 30 WATT FLUORESCENT FIXTURE
NOT SHOWN	999-1093	CONTROL PNL & HINGE - SILVER
NOT SHOWN	999-0167	LEG LEVELER 1/2 - 13 X 4"
NOT SHOWN	999-0169	CASTER 160 - 2 1/2

NOTE: Your game will come equipped with a Wells Gardner 29" monitor Model #WGM-2972-U0T-529K.

② SW UNIT

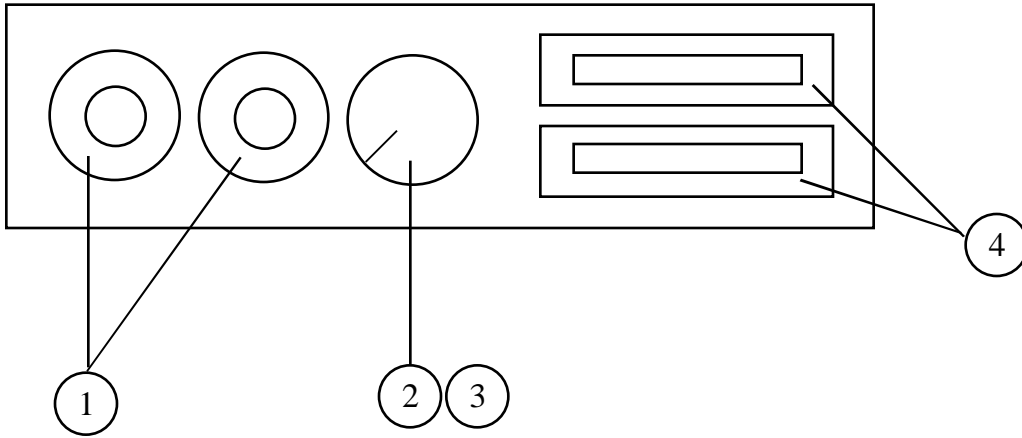

ITEM NO.	PART NO.	DESCRIPTION
1	509-5028	SW PB 1M
2	220-5179	POT 5K OHM 31VA305
3	601-0042	KNOB 22MM
4	999-1050	COIN METER

③ AC UNIT

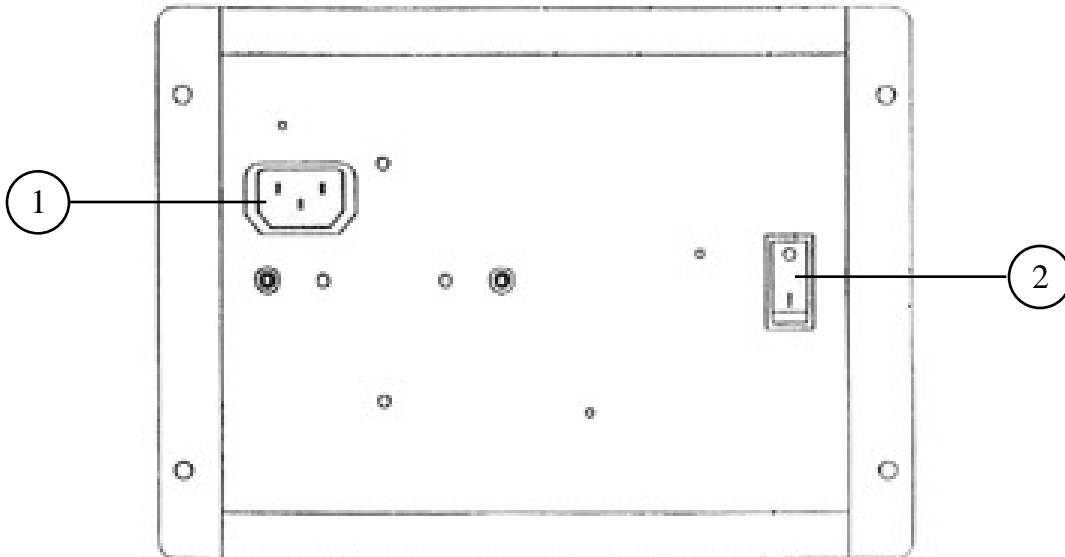

ITEM NO.	PART NO.	DESCRIPTION
1	999-1044	AC INLET PANEL TYPE
2	999-0676	SW ROCKER J8 V-B

④ ASSY POWER SUPPLY

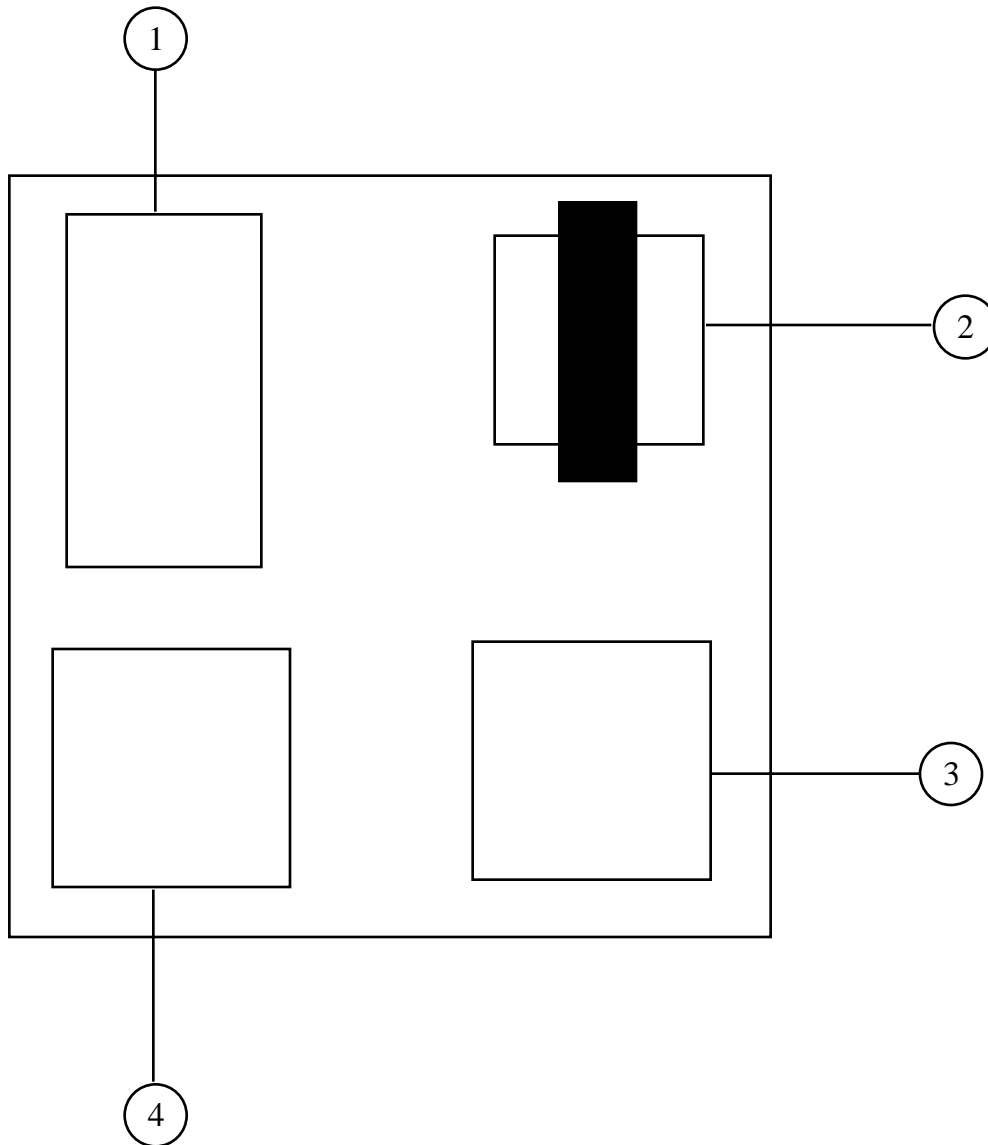

ITEM NO.	PART NO.	DESCRIPTION
1	400-5397-01	POWER SUPPLY
2	999-0141	TRANSFORMER MCI-4-49-703
3	838-13616	AUDIO POWER AMP 2CH
4	837-13551-92	I/O CONTROL BOARD FOR JVS

## 8. WIRE COLOR CODE TABLE

THE WIRE COLOR CODE is as follow:

- A PINK
- B SKY BLUE
- C BROWN
- D PURPLE
- E LIGHT GREEN

Wires other than those of any of the above 5 single colors will be displayed by 2 alphanumeric characters.

- 1 RED
- 2 BLUE
- 3 YELLOW
- 4 GREEN
- 5 WHITE
- 7 ORANGE
- 8 BLACK
- 9 GRAY

If the right-hand side numeral of the code is 0, then the wire will be of a single color shown by the left-hand side numeral (see the above).

Note 1: If the right-hand side alphanumeric is not 0, that particular wire has a spiral color code. The left-hand side character shows the base color and the right-hand side one, the spiral color.

<Example> 51 \*\*\*\*\* WHITE/RED

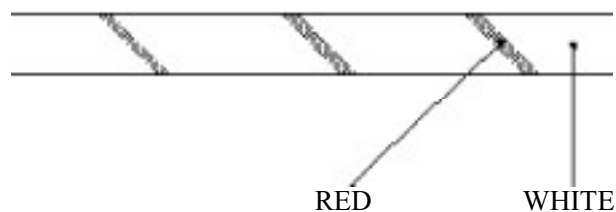

Note 2: The character following the wire color code indicates the size of the wire.

- U: AWG16
- K: AWG18
- L: AWG20
- None: AWG22



*VISIT OUR WEBSITE!*

The image shows a screenshot of a Netscape browser window displaying the SegaService.com website. The browser's address bar shows the URL <http://www.segaservice.com/>. The browser's toolbar includes buttons for Back, Forward, Refresh, Stop, Home, AutoFill, Source, Larger, and Smaller. The browser's status bar at the bottom indicates "Opens the next page. Disabled because the current page is the last page."

The website's header features the "SEGA SERVICE" logo in a stylized blue font. Below the logo, there is a search criteria bar with the text "Search criteria:" followed by a list of search terms: [parts](#), [boards](#), [monitors](#), and [distributors](#). The main content area displays the "SEGA SERVICE" logo again, followed by a list of links: [Darl's Office](#), [What's New](#), [Game Manuals](#), and [Bulletin](#).

The left sidebar contains a navigation menu with the following links: [what's new](#), [manuals](#), [bulletins](#), [assy pages](#), [staff](#), [Darl's Office](#), [corporate info](#), [technical service](#), [warranty Policy](#), [plug ins](#), [home page](#), [non-framed page](#), and [seu mailing list](#). Below the menu, the contact information for Sega Enterprises Inc., USA, is provided: Service Department, phone 415.701.8580, fax 415.701.8594. A "Best viewed @ 800x600" message and a small logo are also present.

At the bottom of the main content area, there is a link to a search engine: [\[what's new\]\[manuals\]\[bulletins\]\[staff\]\[Darl's office\]\[technical service\]\[customer service\]\[corporate info\]\[plugins\]\[Non-framed page\]](#). Below this link, a statistic is displayed: "A total of **5383** people have accessed this page since June 9th."



**SEGA ENTERPRISES, INC. (USA)**

45133 Industrial Drive  
Fremont, CA 94538  
**(415) 701-6580** phone  
**(415) 701-6594** fax