

FLIGHT MANUAL



SPACE SHUTTLE — A JOURNEY INTO SPACE™

EQUIPMENT NOTE

This Flight Manual describes the controls used when running the SPACE SHUTTLE program on the Commodore 64 computer. The program comes with an overlay which fits around the function keys to provide a quick reference to their uses. All the keys used to control the flight of the Space Shuttle are shown below:

FLIGHT SELECTION	→	F 1
MAIN ENGINE ON/OFF	→	F 3
CARGO BAY DOORS	→	F 5
LANDING GEAR	→	F 7
RCS ENGINE	→	T
OMS ENGINE	→	R
STATUS	→	Space Bar
PAUSE	→	⌘ (Commodore Key)
PROGRAM RESET	→	RUN/STOP

FLIGHT PREPARATIONS	4
LAUNCH	6
STABILIZING ORBIT	8
DOCKING	9
DEORBIT BURN	12
REENTRY	13
LANDING	16
ORBITAL MECHANICS	18
ORBITAL MANEUVERING SYSTEM	19
PROBLEMS & SOLUTIONS	20
EARNING YOUR WINGS	23
FLIGHT NOTES FROM STEVE KITCHEN	24
ACRONYMS	25
STAT MESSAGES	26
GLOSSARY	28
ORBITER EXTERIOR	28

Space Shuttle—A Journey Into Space™ is dedicated to the men and women of the National Aeronautics and Space Administration (NASA), without whose kind assistance this cartridge would not have been possible.

FLIGHT PREPARATIONS

MISSION PROFILE

You are in control of the Space Shuttle Discovery, on the 101st Shuttle mission of the Space Transportation System. Your target is an orbiting satellite approximately 210 nautical miles above the Earth.

Your mission: To launch, rendezvous, and dock with the satellite as many times as you can, using the minimum of fuel, then return safely to Earth. A word of caution: Each time you successfully dock, the satellite's orbit becomes more erratic.

This is a total test of your piloting capabilities. You will be evaluated at the end of your flight.

EQUIPMENT CHECK

Flight Mode Selector Key  Press to cycle through Flight Mode options (see "Flight Selection").

Launch Countdown Key  After Flight Mode is selected, press to initiate countdown clock.

Primary Engine On/Off Key  Press to start Primary Engine 4 seconds before launch; press again when orbit altitude is reached.

Cargo Door Key  Press to open/close cargo bay door when orbit altitude is reached.

Landing Gear Key  Press to lower landing gear just prior to touchdown.

Joystick Controller A realistic directional hand controller. Forward and back moves Shuttle forward or back (X axis). Left and right controls left/right movement (Y axis). With red button depressed, forward or back stick movement moves shuttle up or down (Z axis). See "Maneuvering in Space" for further explanation. Also, the red button has other uses in Launch, Orbit, and Reentry phases as described in those sections.

Status Check (Space Bar). Press to cycle through readouts of this important information: Position, axes, Mission Elapsed Time, and Remaining fuel (Flight #3).

Pause Key  Press to suspend and resume all mission systems operation. Use this key to "freeze" the program if you need time to refer to this Flight Manual, or to plan upcoming maneuvers.

FLIGHT SELECTION

There are three different flight modes. Spend time with training flights #1 and #2 before taking on all the challenge of a real, unassisted Shuttle mission (Flight #3). Flight can only be selected before countdown begins.

Flight #1 Autosimulator Flight mode #1 is a combination demonstration flight and autosimulator. The Shuttle flies an abbreviated mission. You do not use any of the console controls. In this flight mode, most aborts (see "Abort indicator") are ignored. Whenever you touch the Joystick, you can take control from that point until rendezvous. Then, you can only use the Joystick Controller to correct your Y axis, and land.

Flight #2 Simulator Astronauts spend thousands of hours practicing in ground-based simulators before flying an actual Shuttle mission. In this mode, experience the challenge and demands of a real mission—with a couple of important exceptions: You don't use any fuel units, so you have all the time you need to complete a mission. Also, onboard computers will assist you during flight by compensating for less-than-perfect piloting skills. Most aborts are overridden, but your flight indicator display will alert you when you've erred.

Flight #3 STS 101 A full-fledged Shuttle Flight. All aborts are operative and flight conditions are quite realistic. Good luck!

FLIGHT EVALUATION

Abort Indicator: If critical problems occur any time during a flight, you may receive a "Launch Scrub" or "Mission Abort" signal. If this happens, your flight has ended. Check and look up C/W number to find out what went wrong.

Ranking: If you safely land the Shuttle at Edwards Air Force Base, in Flight #3, your performance will be computer-evaluated. Your ranking will be determined by the number of successful dockings and the number of fuel units remaining at the end of your flight.

RANKING	DESCRIPTION	QUALIFICATIONS	
		(Dockings)	(Minimum fuel units)
Commander	Responsible for overall crew safety and flight execution.	6 or greater	7500
Pilot	Second in command, assists in all flight functions.	4,5	4500
Mission Specialist	Qualified to coordinate mission scientific objectives.	2,3	3500
Payload Specialist	Qualified to operate specific payloads and coordinate Shuttle housekeeping.	1	1

See "Earning Your Wings" for important club information.

LAUNCH: DAWN, CAPE CANAVERAL

OBJECTIVE

Launch your Space Shuttle and attempt to arrive as close to the satellite's orbit as possible.

LAUNCH CHECKLIST

Launch Phases As you fire your enormous main engines and liftoff from the pad, you'll be going through 3 separate phases. The numbers 1, 2, 3 on your computer screen refer to points along the track where: (1) SRB's (Solid Rocket Boosters) are fired, (2) the Shuttle reaches maximum acceleration, (3) engine shutdown approaches. The X indicates MECO, (Main Engine Cut-Off).

Thrust Notice the two long horizontal bars on the control panel. "T" stands for thrust, "C" for computer. The "C" arrow represents a signal from the onboard computer indicating the proper thrust needed during each phase of liftoff. You control Thrust with the red button on the Joystick. Keep both "T" and "C" arrows aligned. Whenever the "T" arrow flashes, you are wasting fuel and should immediately press the red button to increase or decrease thrust.

Hold Down Bolts Though your engines are firing, you won't leave the launch pad until MET +3. The "Hold Down Bolts" will keep your Shuttle on the ground until your engines develop enough thrust to overcome the force of gravity.

Trajectory/Plane In addition to regulating thrust, you also need to follow the correct trajectory (Joystick forward/back) and adjust your "plane" (Joystick left/right).

Line Horn If you stray from the indicated launch trajectory, you will waste fuel. To alert you that this is happening, a warning horn will sound. This alarm can help you avoid an abort situation.

Separation A yellow flash at about 26 nautical miles will indicate Solid Rocket Booster separation (SRB SEP). Another flash shortly after MECO (Main Engine Cut-Off) will alert you that the Main External Tank has fallen away into the Indian Ocean (ET SEP).

LAUNCH SEQUENCE

1. Press **[F1]** to select Flight Mode 1, 2, or 3.
2. Wait approximately 5 seconds for all systems to become operational.
3. When digital countdown clock appears, press **[L]** to start countdown.
4. When countdown starts, press **[F3]** to activate Main Engine.
5. At MET-004, press red button to ignite Main Engine, then use this button to keep "T" and "C" arrows aligned until you reach orbit.
6. Watch Trajectory Tracking Screen and use the Joystick to maintain correct ascension track and left-right alignment (Horn sounds to warn you of trajectory variance).
 - Move Joystick forward or backward to maintain correct trajectory course. Try to stay on or just below the plotted line.
 - Move Joystick left or right to keep dot centered in small "plane indicator" box.
7. At about 200 nautical miles, press **[F3]** to shut off the main engine. The closer you come to the 210 altitude, the nearer you'll be to the target satellite's orbit. **WARNING:** If you shut off the main engine at less than 195 miles, the Shuttle will fall to Earth!

Launch & Ascent Summary Flying the Shuttle into orbit is an extremely challenging task. Following a roller coaster path, you must continually match engine thrust with the computer indicator, stay on the course shown on the trajectory display, and correct your plane as indicated in the small box. Each area is critical. Incorrect trajectory burns up extra fuel and may abort your flight. If plane is far out of alignment at MECO it will be much more difficult to dock with the target satellite.

Warning: On your way into orbit you'll see familiar constellations ahead, through the darkening sky. Don't be distracted—keep your concentration on the demanding task of staying on course!



TRACKING SCREEN

STABILIZING ORBIT

OBJECTIVE

Establish a stable orbit by opening Cargo Bay Doors for heat release, and adjusting Shuttle position to achieve visual contact with Earth.

STABLE ORBIT CHECKLIST

Cargo Bay Doors Your first task is to open the Cargo Bay Doors. This is vital and must be done during the first orbit. Radiators that shed excess heat generated during launch are on the inner surfaces of these doors. If the doors remain closed, heat builds up inside the Shuttle and the warning horn sounds. You then have just 30 seconds to open the doors; if you don't, the mission will be aborted.

Nose Down Maneuver When the Shuttle first achieves orbit, the nose of the craft is pointed up out of the line of sight of the satellite. In order to dock, you must see the satellite. Adjust the pitch to bring the Shuttle's nose down. When you do this, you'll be able to see the blue Earth through the window.

SEQUENCE TO STABILIZE ORBIT

1. Press **[I5]** to open Cargo Bay Doors.
2. Press **[R]** to activate OMS Rotational Engine.
3. Move Joystick forward or back to set pitch to -28.

STABLE ORBIT SUMMARY

Cargo Bay Door opening and pitch adjustment must be performed on the first orbit revolution before any further operations should be attempted.



DOCKING: 210 NAUTICAL MILES IN SPACE

OBJECTIVE

Adjust the speed and position (X, Y, and Z axes) of the Shuttle and successfully rendezvous with the satellite.

DOCKING CHECKLIST

Maneuvering in Space There are two different ways to maneuver the Shuttle in orbit. For major maneuvers (30 nautical miles or more), the Orbital Maneuvering System (OMS) can be used. This system (explained in a later section) takes some study and experience to use effectively. So, when first starting out, use the Reaction Control System (RCS). Its clusters of rocket engines in the Shuttle's nose and tail can move the Shuttle about its three major axes X, Y, Z. Watch the firing of RCS thrusters in the inset display on the screen.

- To use the OMS, press **R** to activate ROT (Rotational Engine). Lean Joystick left or right to affect Yaw; forward or back to affect Pitch. Press red button to fire engine.
- To use the RCS, press **T** to activate TRN (Transitional Engine). Lean Joystick left or right to affect Y axis; forward or back to affect speed (and X axis); forward or back while pressing red button to affect altitude (Z axis).

Shuttle Speed and Position Speed is just as important as position. Never allow your speed to drop below mach 17.0, or your altitude to fall below 195 nautical miles, or you'll burn up in the atmosphere! Your X axis relationship to the satellite depends on your speed, which is affected by your engine. To overtake the satellite when it is ahead of you (when the X axis value is positive), your speed must be greater than 23.9. As you make your final approach to the satellite, keep speed close to mach 23.9.

Drifting As you near the satellite, continually recheck all axes. Settings will shift, and the satellite's movement is erratic. When RCS is active (TRN is on), press **X**, **Y**, or **Z** to display current status of those axes. Or press the Space Bar at any time to check position, remaining fuel, and Mission Elapsed Time.

DOCKING: 210 NAUTICAL MILES IN SPACE

"S" Curve On the Ground Track Screen, the "S" line indicates both the Shuttle's and the satellite's ground track around the Earth. The Shuttle's position is the solid dot; the flashing dot is the target satellite. Notice as you track the satellite, your X axis (distance between Shuttle and satellite) will suddenly change significantly as the satellite "wraps around" the tracking line. This is because the orbital tracking line wraps around the display as a real orbit would wrap around the Earth.

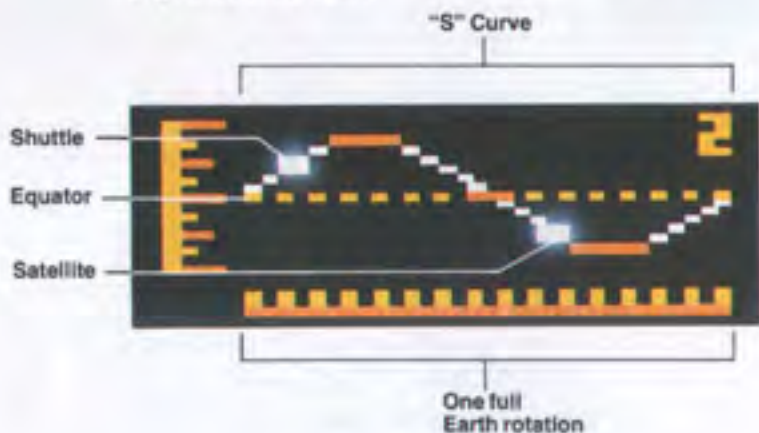

GROUND TRACK SCREEN

Docking Screen Use the "S" curve screen until you get fairly close to the satellite. Then, two smaller radar screens will appear. The left screen shows your Z axis (up-down), and a wide view of your Y axis (left-right). The right screen, which you'll use more, shows the X axis and micro (close in) Y axis.

Satellite Sighting When you see the satellite, prepare to conduct close range maneuvers with the RCS (TRN engine on). The satellite appears to change colors as it passes in and out of the sunlit side of Earth.

Multiple Dockings Every time you dock (in Fit #3), you receive a "Rendezvous" signal and some additional fuel units. Each additional docking becomes more difficult, so the amount of fuel you get increases. After each rendezvous, the satellite moves away from the Shuttle. Wait until it is at least 80 units away before attempting to dock again.

DOCKING SEQUENCE

Match the position of the Shuttle with that of the satellite's by correcting Z, Y and X axes, preferably in that order.

1. Press **T** to activate RCS.
2. Correct Z axis to 0: Press red button and move joystick forward or back. A negative number means the satellite is below you. A positive number means the satellite is above you. A zero reading means your altitude is the same as the satellite's.
3. Correct Y axis to 0: Move Joystick to the right or left. A positive number means the satellite is right of you, so tap the Joystick right to line up with it. A negative number means the satellite is to the left of you. Move the Joystick to the left.
4. Correct X axis: Move the Joystick forward or back. A positive number shows the distance units the Satellite is ahead of you. A negative number shows how far it is behind you. To increase Shuttle speed, move Joystick forward. To decrease speed, move Joystick back. The satellite's speed is always mach 23.9.
5. When you meet the satellite, all axes must be adjusted to 0, and stabilized for 2 seconds. Then you will receive a "Rendezvous" signal, indicating that you've docked.

DOCKING SUMMARY

You are attempting to dock with a satellite that is travelling at mach 23.9, several hundred nautical miles above the Earth. You will have to slow down or speed up to reduce distance (X axis) to 0. Also, you will have to be at the same altitude (Z axis) and position (Y axis). All of these movements are interrelated—changing one can affect the others. And, in Flight Mode #3, time is important, because the longer you take, the more fuel you consume. Tap the Joystick instead of holding it in a control position to save fuel.

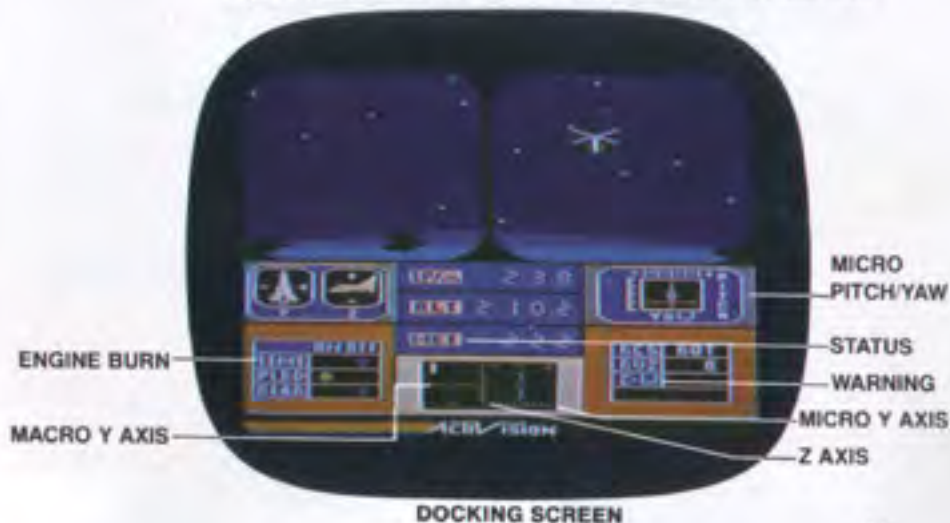

DEORBIT BURN

OBJECTIVE

To turn the Shuttle around, fire the engines, and decelerate to the correct speed for leaving orbit.

DEORBIT CHECKLIST

Deorbit Burn Maneuver First, you must turn the Shuttle around so that it is traveling tail-first. Then, in order to maintain the correct altitude, set your Z axis and pitch. Once this maneuver is completed, fire the engine to decelerate. If the Z axis and pitch are not set correctly, firing the engines will make your Shuttle climb or dive. After the deorbit burn, the Shuttle must then be reoriented nose-forward to the correct attitude. Entering the atmosphere backwards will cause the Shuttle to burn up!

Yaw Left-right rotation of the nose of the Shuttle.

Satellite Interference Before starting deorbit burn, you must wait until you see a dramatic change in your X axis. If you don't, your deorbit burn will be unsuccessful, and you'll never leave orbit!

SEQUENCE FOR DEORBIT BURN

1. Adjust Z axis until altitude reads 210.
2. Pull Joystick back or push Joystick forward to set speed to mach 23.9.
3. Press **[R]** to activate OMS.
4. Turn Shuttle around completely. Move Joystick left or right to set Yaw at 180.
5. Set pitch at -004.
6. Press fire button until speed is mach 19.0.
7. Turn Shuttle around nose-forward by resetting Yaw to 0.

DEORBIT SUMMARY

Deorbit is one of the most critical phases of your flight.

During deorbit operations, the Shuttle is oriented to a tail-first attitude, decelerated to reentry speed by the powerful OMS engine, then turned around to a nose-first attitude.

You begin to lose altitude when you've slowed the Shuttle down below the speed needed to sustain orbit at 210 nautical miles.

OBJECTIVE

To establish and maintain the correct pitch, yaw and speed; follow the correct trajectory; and properly manage heat build-up during reentry.

REENTRY CHECKLIST

Entry Interface This is the point in your flight where atmospheric entry officially begins. As the Shuttle descends, atmospheric drag dissipates tremendous energy, generating a great deal of heat. This heat quickly builds up (portions of the vehicle's exterior reach 1,540°C). Pitch and speed must be correct to properly utilize the Shuttle's Thermal Protection System.

Terminal Area Energy Management After entry interface, you must closely follow the proper descent trajectory in order to maintain enough altitude and speed to reach the final touchdown point. This process of conserving your energy by maintaining the correct position, altitude, velocity and heading is called Terminal Area Energy Management (TAEM).

Loss of Signal During reentry, the Shuttle superheats the gas of the upper atmosphere, creating flashes of color outside your window. Heat strips electrons from the air around the Shuttle, enveloping it in a sheath of ionized air that blocks all communication with the ground. So, at 160 miles, you will experience a temporary partial loss of signal (LOS). Keep a close eye on your radar at this point. You will receive intermittent signals which you need to use to correct your course and plane.

Descent Screens On your reentry screen, "X" indicates cut-off of your OMS engines (deorbit burn). "T" indicates the Terminal Area Energy Management Phase. "L" indicates your transition to final landing approach. The small box at left is your plane indicator.

REENTRY

REENTRY SEQUENCE

1. Pull back Joystick to set + 24 pitch for proper reentry attitude.
2. Close Cargo Bay Doors.
3. Follow reentry course on computer screen. Pull stick back to go right; push forward to go left. Left and right on stick centers plane.

REENTRY SUMMARY

There are three important stages to Reentry: Entry Interface, TAEM and LOS. Position, altitude, velocity and heading must all be exact to both properly manage the tremendous heat buildup and correctly position your shuttle for the Final Approach.

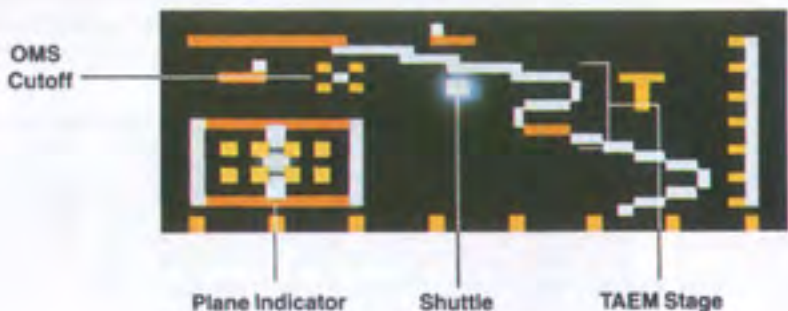

REENTRY SCREEN

RETURNING TO EARTH

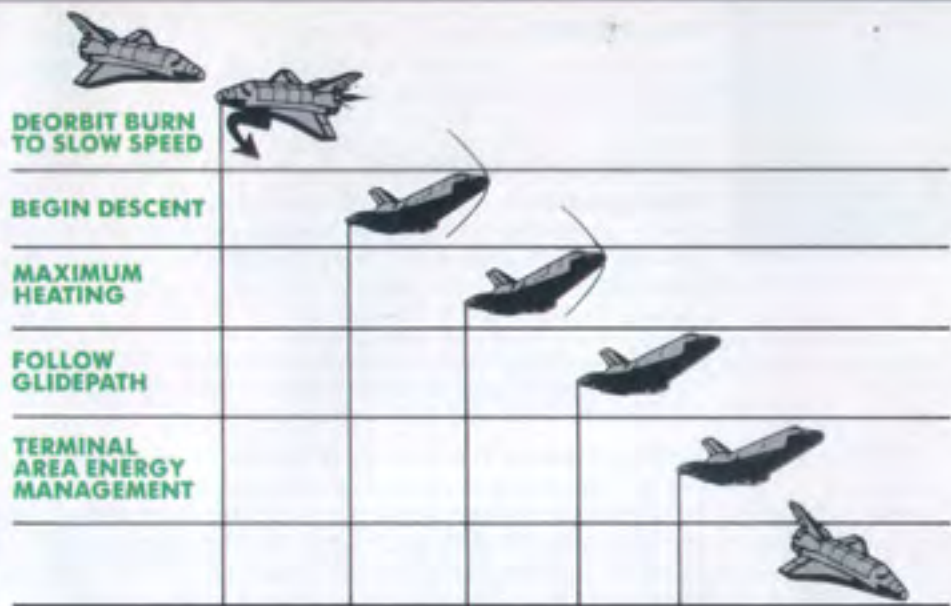

TURN TO BEGIN
FINAL APPROACH

BEGIN TO PULL
NOSE UP

PREPARE TO
DROP GEAR

WHEELS DOWN

TOUCHDOWN

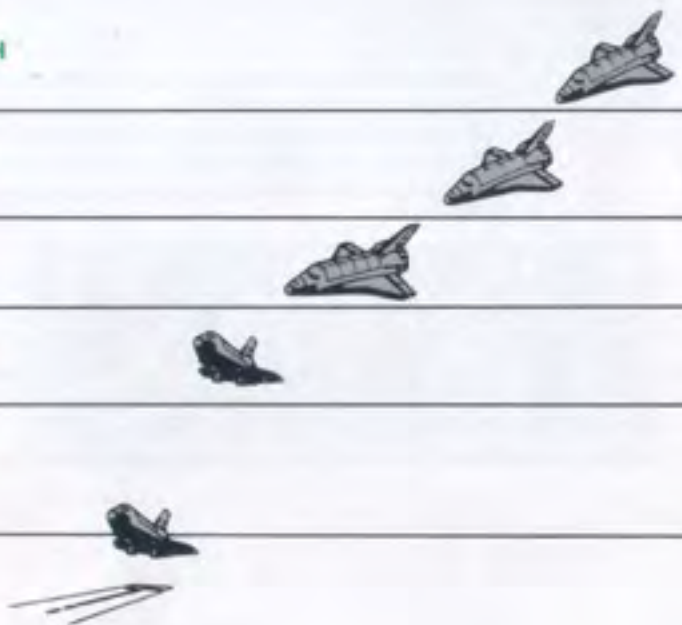

LANDING: EDWARDS AIR FORCE BASE, CALIFORNIA

OBJECTIVE

Properly following the final approach course, maintain the correct pitch and descent rate to safely land.

LANDING CHECKLIST

Final Approach As you leave the reentry phase and enter your final approach, the first thing you'll see are the mountains around Edwards Air Force Base. You'll hear two sonic booms caused by your craft and the chase planes. At this point, your Shuttle is a glider.

In order to maintain enough altitude and speed to reach the touchdown point, you'll need to make an extreme right turn which will leave you lined up with the runway entry point.

Landing Screens Now, closely watch all your flight instruments on the front control panel. At this point events happen quickly. You will need to keep your nose pulled up to slow descent while constantly watching altitude and range. Lines on the left screen box, (Altitude Direction Indicator) indicate the ideal trajectory or path and your upper and lower safe limits. The right box is your Horizontal Situation Indicator. It shows your position relative to the runway.

Range Range is the distance from the edge of the runway to your shuttle. So, when range is negative you're above the runway.

Surface Conditions Since you're in the desert, crosswinds can become a real problem. Compensate by constantly moving Joystick left-right and forward-back to maintain the proper trajectory and descent rate until touchdown. Just because you're close to home—don't let up on your concentration.



LANDING SEQUENCE

1. As soon as you see the mountains, watch for the runway. Use the right radar screen to maintain alignment.
2. Follow final approach course on both computer screens. Left screen: Keep dot centered between the two arched lines. Right screen: Keep dot centered on straight runway approach line. Push Joystick forward to lower nose (quicken descent). Pull Joystick back to raise nose (slow descent). Push Joystick left or right to keep dot centered.
3. When range goes negative, you're over the runway, just seconds from touchdown, so drop landing gear now.
4. Push Joystick forward to lower nose.
5. When Shuttle hits runway, your nose will pop up, so keep Joystick pushed forward to keep nose down until you hear the thud of the front landing gear.

LANDING SUMMARY

During the final approach, descent speed is critical. You will be conducting a series of "flares" (nose-up maneuvers) that reduce speed which is necessary for landing. So, not only will you need to center the Shuttle on the runway, but also you must maintain the proper pitch at the same time. Sounds are important during this phase. Use them to monitor your progress. In addition to the sonic boom as you break through the atmosphere, you'll hear a constant beeping effect which will increase in speed the closer you get to the runway, a high-pitched warning horn after you've passed over the runway (a signal to put your landing gear down), landing gear lowered, and (main gear) tires screech when you've touched down.

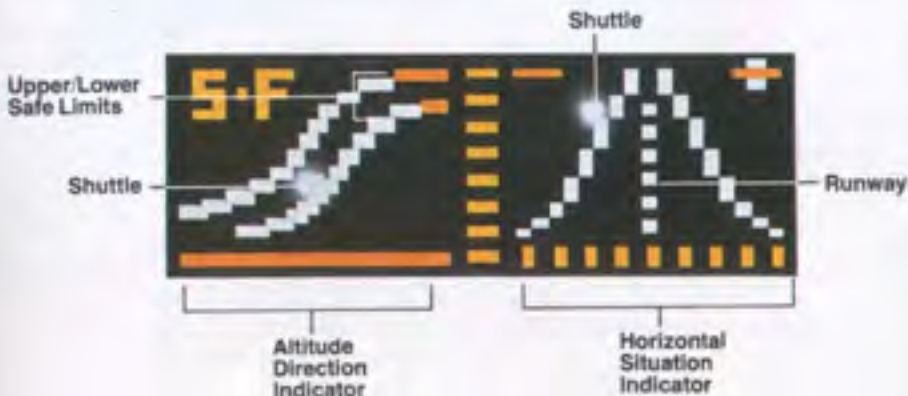

FINAL APPROACH SCREEN

You've successfully launched your Shuttle into orbit. Now, it's time to dock with the satellite. Whether you're making position corrections using the OMS or RCS engines, remember that every action you take may affect your axis (X, Y, Z) or altitude. For example, if your pitch is -028 (nose-down) and you perform an OMS burn to correct your X axis, your altitude will drop because you're actually pointed towards Earth.

Try and picture the position of the Shuttle in your mind as you're orbiting. Use the diagram below (also on your Flight Deck Console) to help you visualize Shuttle positioning. And remember: minimum speed is Mach 17.0 and minimum altitude is 195 nautical miles, or your orbit will destabilize and the vehicle will burn up in the atmosphere.

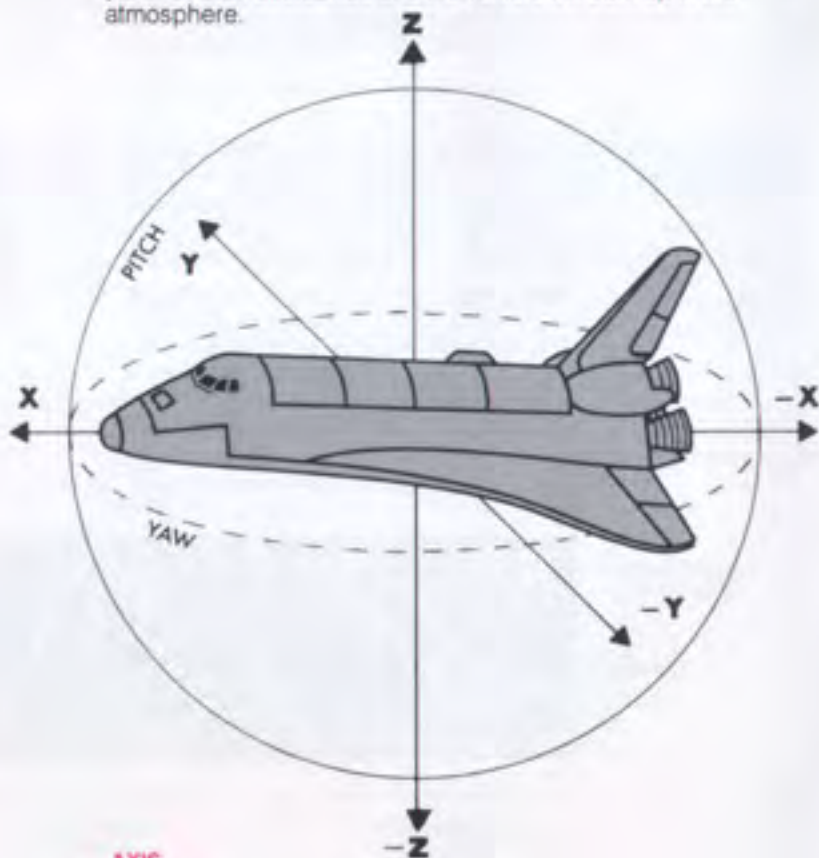

AXIS

Z = Vertical distance to earth

Y = Left and right distance to satellite

X = Forward and back distance to satellite

PITCH = Up-down of the nose of the craft

YAW = Left-right rotation of the nose of the craft

For smaller, precise adjustments, you'll perform orbital maneuvers with the Reaction Control System (RCS) engines. They're easier to use. However, time means fuel. "Housekeeping" fuel—which keeps electrical and life support systems of the Shuttle operating—is constantly being expended. So it's imperative you make your orbital corrections as efficiently and quickly as possible. This is where the OMS can help. When making major maneuvers, use the 12,000-pound-thrust OMS engines. Since these powerful engines can radically affect altitude, *read the following details carefully:*

When flying forward (0 Yaw) powered by OMS engines, altitude will drop faster if your pitch is zero or negative. When flying backwards (180 Yaw), your altitude will rise only if your pitch is positive or zero.

X AXIS CORRECTIONS USING OMS ENGINES

Sequence

1. Set pitch to correct value.
2. Check X axis.
3. Set yaw to 180 if X value is negative; to 0 if X is positive.
4. Push red button to fire engines.
5. Restore yaw and pitch to correct values.

As you perform a Y axis OMS burn, you'll see your Y indicator change. If you forgot to change your pitch to 0, your altitude will change. A positive pitch will make you rise. A negative pitch will make you fall. A non-zero pitch also burns extra fuel.

Y AXIS CORRECTIONS USING OMS ENGINES

Sequence

1. Set pitch to correct value.
2. Check Y axis.
3. If Y is positive, set yaw to 90; if negative, set yaw to 270.
4. Push red button to fire engines.
5. Restore yaw and pitch to correct value.

As you perform a Z axis OMS burn, note that you will not see the Z indicator change. So, calculate Z axis burn beforehand by adding/subtracting Z value to current altitude to arrive at desired final altitude.

Z AXIS CORRECTIONS USING OMS ENGINES

Sequence

1. Set yaw to 0.
2. Set pitch to 36 to climb; -28 to fall.
3. Press fire button until desired altitudinal goal is reached.
4. Restore pitch to prior settings.

OMS Summary When correcting either X or Y axis using OMS engines, your altitude may be affected. But it IS possible to make Z and X or Y corrections in a single maneuver—if very skillfully done.

LAUNCH: PROBLEMS

PROBLEM: "Launch Scrub."

SOLUTION: You're igniting your engines prior to or too long after MET-004. Wait for launch systems to recycle and concentrate on firing as close to (but not before) MET-004 as possible.

PROBLEM: Line horn continually sounds during launch.

SOLUTION: Keep dot (your Shuttle) slightly on the low side of the trajectory line to maintain proper course.

STABILIZING ORBIT: PROBLEMS

PROBLEM: Initial orbit position too low, or speed too slow.

SOLUTION: You're shutting off your engines before proper altitude is achieved. Cut-off your main engines as close to 205 miles as possible.

PROBLEM: "Mission Abort" signal as soon as you shut down engines.

SOLUTION: Dependent upon your Abort number, either: speed/altitude were too low to sustain orbit; you were far off the trajectory line at MECO; you shut down your engines too early, or your orbit insertion angle was incorrect. Either you were very far off the trajectory line or your plane (right-left position) was incorrect.

PROBLEM: Once in orbit, Y axis is off badly.

SOLUTION: Plane (right-left) was not centered at MECO.

PROBLEM: Once in orbit, Z is off badly.

SOLUTION: You shut down your engines too early. Remember, your Z axis is directly related to your altitude. The lower your altitude, the more negative your Z axis. A Z-15 axis equals an altitude of 196.0 miles. When Z axis equals 0, altitude is 210 nautical miles, the altitude of the orbiting satellite.

DOCKING: PROBLEMS

PROBLEM: Although axes are adjusted, satellite is never sighted and docking screens never appear.

SOLUTION: Check your pitch and Yaw. If pitch is not -28 (Shuttle nose-down), you'll never be in line of sight of satellite. If Yaw is $+$ or -17 or greater, you'll also be out of line of sight (Shuttle line of sight will be too far left or right). With Z and Y axes adjusted to 0, docking screens should appear when the satellite is at X $+$ or -16 , assuming pitch is -28 and yaw $= 0$.

PROBLEM: Conducting OMS burn sends Shuttle into dramatically high or low altitudes.

SOLUTION: Check your pitch. Always make sure your pitch is 0 before conducting an OMS burn unless you intentionally wish to adjust your altitude during burn.

PROBLEM: Axes all adjusted. Satellite spotted. But, you can't dock.

SOLUTION: Check your speed. The satellite always travels at Mach 23.9. So, if you're having trouble docking, adjust Shuttle speed $+$ or -1 Mach.

REENTRY: PROBLEMS

PROBLEM: After conducting a successful Deorbit Burn, you still aren't losing altitude for reentry.

SOLUTION: The Satellite may be interfering. Wait until X value changes dramatically and the "S" Curve reappears before conducting a deorbit burn. Also, make sure your pitch is negative before conducting a deorbit burn. Speed after burn should be mach 19.0.

PROBLEM: Burn up during reentry.

SOLUTION: If your pitch is less than + 24, your Shuttle cannot be protected by its special insulation. If pitch is greater than + 24, you'll skip into space. If yaw does not equal 0, you'll spin out. And if your Cargo Bay Doors are left open, your Shuttle will also burn up.

LANDING: PROBLEMS

PROBLEM: Mission Abort as soon as you break through the cloud covering.

SOLUTION: You cannot be off course (Klaxon horn is on) during the last few seconds of your reentry (screen). This will place you in the wrong position for Final Approach—altitude and speed will be adversely affected! So, stay right on course at the end of reentry—don't let up.

PROBLEM: You crash into the desert floor.

SOLUTION: This is probably a result of incorrect use of your Altitude Direction Indicator (ADI). The ADI is the left display screen shown during landing. It tracks your altitude and descent. Always keep the Shuttle between its two lines.

Or, you may be off course. Watch carefully for the runway; it's hard to see from a great distance. Keep the Shuttle location between the lines of the Horizon Situation Indicator (HSI), the right display screen shown during landing.

Remember, as soon as you drop the landing gear, drag causes the nose to flare up. So, when the landing gear is dropped, keep pushing the Joystick forward to force the nose down.

EARNING YOUR WINGS

Pilots are a skilled and hearty breed indeed. If you're able to successfully dock your Shuttle five times and land with at least 4,500 units of fuel, you're worthy of Pilot status and an official Pilot patch.

If, after hours of hard training, study and preparation, you make that sixth and final satellite docking with at least 7,500 fuel units in your tanks, you'll be one of the few, the proud, the elite—Space Shuttle Commanders! Anyone achieving this magnificent ranking will be rewarded with a distinguished on-screen display! Snap a photo of the TV screen, and we'll send you the appropriate patch shown below.

Be sure to write "Space Shuttle" on the bottom left hand corner of the envelope.



LANDING SCREEN

FLIGHT NOTES FROM DESIGNER, STEVE KITCHEN

"Ever since I can remember, the Space Program has meant something very special to me. Every time a mission took off, so did my imagination.

"That's why designing a home video version patterned after the real Space Shuttle seemed so appealing—yet challenging. It was quite a task to achieve maximum accuracy in my work.

"In the photo on this page, I'm sitting in an actual NASA Space Shuttle simulator. It gave me a firsthand look at what our astronauts really go through. And I can assure you the Space Shuttle cartridge you now have is quite true to real life.

"So, don't be discouraged if you don't achieve Commander on your first flight. There are plenty of skills and a whole lot of knowledge you need to master first. I strongly suggest you fly Space Shuttle with a friend as co-pilot—functioning as navigator and assistant.

"Learn and understand this manual. The knowledge you gain will not only help with my program but, who knows, may get you a seat on the next real trip into orbit."

Steve Kitchen

Steve Kitchen is a master software designer, engineer and inventor. He was involved in the development of digital watches, the first handheld electronic games and electronic calculators. Steve welcomes and encourages your letters, comments and questions regarding his first work for Activision.



ACRONYMS

AX:	Axis
ALT:	Altitude
FLT:	Flight
MET:	Mission-Elapsed Time
MECO:	Main Engine Cut-Off
OMS:	Orbital Maneuvering Systems
RCS:	Reaction Control System
RNG:	Range
SRB:	Solid Rocket Booster
SP/M:	Speed in Mach
SSME:	Space Shuttle Main Engine
STS:	Space Transportation System
TAEM:	Terminal Area Energy Management
DAP:	Digital Auto Pilot

STAT MESSAGES

During the mission the onboard computer will alert you of conditions that could endanger the Shuttle. If an error or condition is bad enough, the screen displays a "MISSION ABORT" signal, from which there is no recovery. Pre-launch errors (such as starting the Main Engine too soon) merely cause a re-start of the countdown sequence. The following messages can appear during the flight, in the "C-W" display window. When you know what these warning codes mean you can, in many cases, take corrective action to save the mission.

MESSAGE NUMBER	MESSAGE OR ACTION NEEDED
(Prelaunch-Non Abort)	
0	All clear
4	Shutdown Primary Engines
24	Shutdown Primary and Back-up Engines
44	Shutdown Primary Engines and close Cargo Bay Doors.
64	Shutdown all Engines and close Cargo Bay Doors.
20	Shutdown Backup Engines.
40	Close Cargo Bay Doors.
60	Shutdown Backup Engines and close Cargo Bay Doors.

MESSAGE NUMBER	MESSAGE OR ACTION NEEDED
(Inflight-Mission Abort)	
0	All clear
1000	Not lined up with runway on touchdown
7000	Altitude too low to sustain orbit (below 195)
7500	Altitude too high (255 miles maximum)
9500	Speed/altitude too low to attain orbit at MECO
1500	Touchdown too early (hit desert)
2000	Touchdown too late (overshot runway)

**MESSAGE
NUMBER**

**MESSAGE OR
ACTION NEEDED**

(Inflight-Mission Abort)

3000	Nose gear not down at end of runway
3500	Off course at start of banking turn (horn is on)
4000	Landing gear not down at touchdown
8500	Cargo bay doors not open during orbit (overheat)
5000	Cargo bay doors not closed at ascent or reentry
8000	Speed too low to sustain orbit (below mach 17.0)
5500	Pitch greater than +24 on reentry (skip into space)
6000	Pitch less than +24 on reentry (burn up)
6500	Yaw not 0 at reentry
9000	Orbit insertion angle incorrect at MECO
9900	Out of fuel

**MESSAGE
NUMBER**

**MESSAGE OR
ACTION NEEDED**

(After safely landing)

1-99	Number of dockings. Also may appear as the last digit of a Mission Abort stat.
------	--

GLOSSARY

- APOGEE:** The highest point of an earth ORBIT.
- ALTITUDE:** Vertical height from Earth's mean surface (sea level).
- ATTITUDE:** The position of the vehicle; for example, flying tail-first with cargo bay toward the earth.
- AXIS:** A line through a body about which it rotates.
- CONFIGURE:** To set equipment to certain specifications.
- DEORBIT BURN:** The firing of a RETRO-ROCKET to slow the spacecraft to a speed lower than that required to maintain ORBIT. On the Orbiter, this is accomplished with the orbiter maneuvering system (OMS) engines.
- GLIDESCOPE:** The angle at which you descend in the Orbiter or other glider with respect to the ground.
- KILOMETER:** 1000 meters, or 0.621 of a mile.
- MACH:** The term used to describe the speed of objects relative to the speed of sound (about 690 mph). For example, Mach 2 is twice the speed of sound. The shuttle travels through space (in orbit) at approx. 22 mach or 17,000 mph.
- ORBIT:** A balance between a body's inertia, or tendency to fly off into space, and the gravitational attraction of a central object.

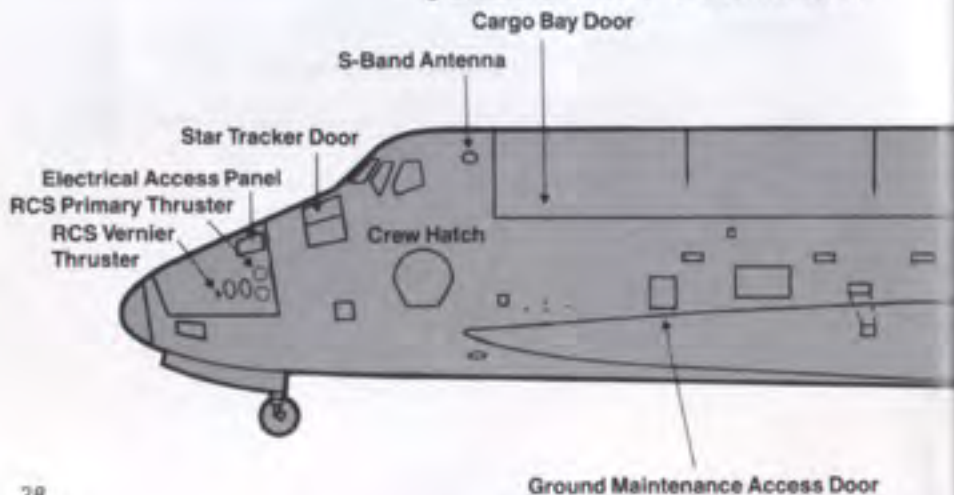

- PITCH:** Up-down rotation of the nose of the craft (see Roll and Yaw).
- RANGE:** Distance to edge of runway.
- RETRO-FIRE:** To fire engines in the direction of motion in order to reduce forward velocity. In orbit, this permits gravity to pull you downward.
- ROLL:** To rotate about an axis from front to back (nose to tail) of the Orbiter. To the pilot, a roll is like a cartwheel (see Pitch and Yaw).
- RENDEZVOUS:** To meet in space and orbit together.
- ROTATION:** Movement of the Orbiter around its three principal axes producing Pitch, Yaw, or Roll.
- TRAJECTORY** Flight Path.
- YAW:** Left-Right rotation of the nose of the craft (see Pitch and Roll).

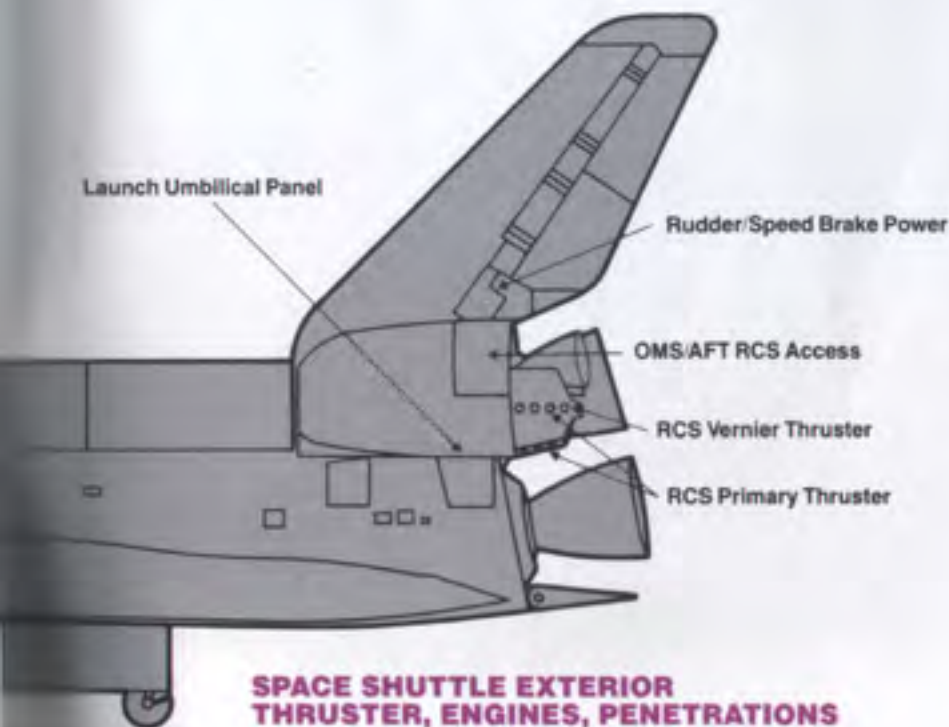

A MATH EXPERIMENT IN SPACE

If you're interested in the mathematical dimension of orbital flight, you may enjoy trying this experiment. All you need is a calculator to solve the following equations. The results can help you reach the target satellite's position the most efficient way, by doing an OMS burn on the shortest, fuel-saving track.

Procedure

1. When you are in stable orbit, press **[T]** to turn on RCS.
2. Set speed at mach 23.9, to maintain a constant X axis.
3. Write down Y and Z axes, then immediately press **[G]** to "freeze" both positions.
4. With a calculator, determine values of T_y and T_p in these equations:

$$T_y = \lfloor [(4.1 + A) (Y/10)] \rfloor$$

where T = Time, $A = 0$, Y = Directional distance
(The result must always be a positive number)

$$T_p = \lfloor T_y/Z \rfloor$$

where p = pitch and Z = Orbital height difference in miles
(The result must always be a positive number)

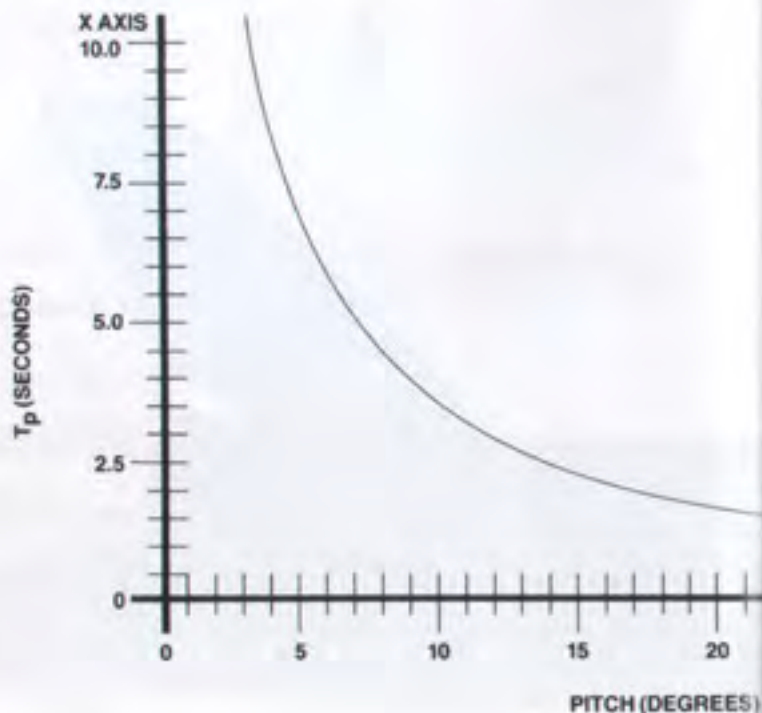
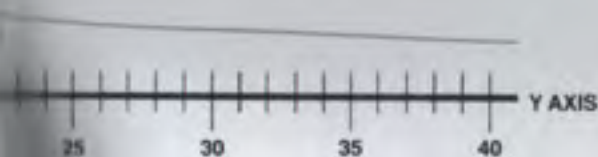

FIGURE 1.1

5. Refer to the graph below. Find the corresponding PITCH for T_p you have just calculated.
6. Use this PITCH value to calculate your angular displacement:
 $A = .5 (P/8)$
 where $P =$ PITCH obtained from graph curve
 NOTE: $P/8$ must be rounded down to the nearest whole number
7. Using this value of A , return to step #4 and recalculate for T_y and T_p .
8. Press \boxed{C} to resume Shuttle control, then \boxed{R} to activate OMS.
9. Set YAW at 90° or 270° if the value of Y is "+" or "-" respectively. The sign of the PITCH value is the same as the Z value used above.
10. During the OMS burn you will move toward the satellite at the same rate that you close on Y to make it zero. The rate of closure is 4 distance units/second (if pitch is zero). The maximum closing speed (if pitch is 36°), is 1 unit of Y for 1.3 units of X .

$$Y = \frac{1}{(.0204x + .2613)^2} ; X = |X|$$



MISSION CONTROL HOTLINE

If you have questions about Space Shuttle—A Journey Into Space™ call (800) 633-GAME anytime on the weekend. In California, call (415) 940-6044/5.

ACTIVISION

ACTIVISION, Inc.
Drawer NO. 7287
Mountain View, CA 94039

Commodore 64™ is a trademark of Commodore Electronics Limited.