

PENETRATE DOMINATE CONQUER

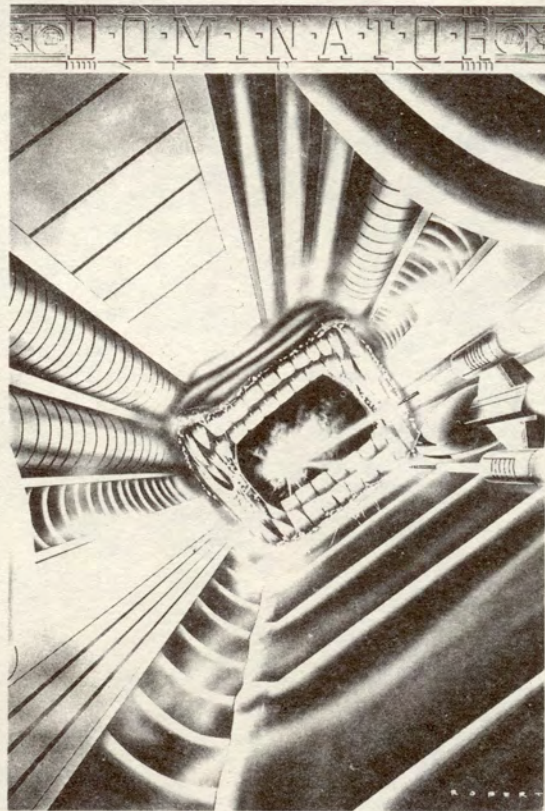

© 1989 System Three Software Ltd. All rights reserved.

OPERATION MANUAL

We at System 3 are continuing in our endeavour to provide you, the games' player, with hours of exciting entertainment through challenging and imaginative gameplay. And the latest product of this endeavour is now at hand ... **DOMINATOR.**

Dominator is a 'shoot 'em up'. But like all System 3 products, it is designed with a difference. To create a new genre in this type of home computer software.

A four load product, Dominator oozes dynamic arcade-style action. It has breathtaking graphics and animated gaming zones which scroll both horizontally and vertically.

YOU are the "Dominator"; the sole survivor of a 'crack' air fighting team, called upon by fellow mankind to confront and destroy an horrendous threat to Earth's existence. Duty compels you to venture inside and destroy the menace by obliterating its vital organs.

We wish you good luck with our exciting new product and look forward to entertaining you long into the future.

Mark Cole

Shrouded by a veil of secrecy, a latent vacuum in the cosmos was to give rise to the dawning of a new era. The words "death" and "destruction" needed reclassification as the gradual metamorphosis of the ultimate killing machine spelt out the fate of whole galaxies. It had begun to move...

Millions of miles away lies Earth. A planet once wrenched into unwanted confrontation with an amoral and hideous alien race, wanting merely to expand its catalogue of occupied star systems. Men, women and children had fought the unwanted visitors. Only hope fired their existence, fuelled by the bravery, determination and sheer guts of Earth's 'crack' defence fighter pilot team.



"They pulled us through" went the cries on the streets when the 'visitors' were eventually beaten, and beaten well. Compassionate tears flowed for these men as Earth mourned the closest ever annihilation of its population. Bloodstained lives entwined to rebuild with a passion and commitment never seen before.

That was then; this is now. Only one hero pilot remains alive.

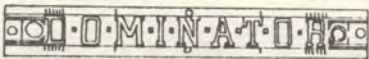

He is the sole survivor of a unit that had been allowed to grow old and dwindle back into the earth for which it had fought so proud. A false sense of security infiltrates the star system as no new blood contemplates the rigorous training and commitment of such a future.

This man is bitter. He shuns society for its broken promises. He yearns to lose himself in battle once again, reminiscing friends and times that had been, and relentlessly he polishes his beloved battle weary spacecraft with the broken depiction "DOMINATOR" scrawled along its side. In those earlier years he was known as the 'Dominator', a title he strived to keep whenever his vision was blurred by nostalgia.

Warnings, S.O.S's and stories of total planet absorption had been banded around a terrified solar system for some time now but had been conveniently overlooked by spineless, bureaucratic so-called 'leaders'.

And now it was too late. This was incomprehensible. This was immense. Its vast appetite was closing in on Earth and the putrid smell of partly digested nations hung ominously in space above a society that had refused to believe that its very existence would ever again be in question.

Who could fight?

Who would dare go inside this mutant horror and battle against its bodily defence mechanisms, to obliterate its sustaining organs, to stop its crazed hunger stampede across the universe?

It started an enquiring whisper, mounting into a crescendo of international hope and worship.

Mankind needs you, the 'Dominator' ... You need to fight ...

IT NEEDS TO FEED ...

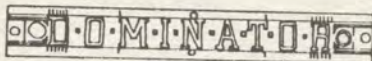
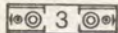

LOADING INSTRUCTIONS

Set up your **computer** system as detailed in your user manual. Ensure that all non essential peripherals – such as cartridges, printers, etc. are **disconnected**. Failure to do so may cause loading **difficulties**.

- 1) If you are using your Commodore 64/128 with the cassette version of DOMINATOR...

Connect your data cassette player and switch your computer and TV/monitor on. C128 owners should now select C64 mode by typing GO64, pressing **RETURN** then **Y**, then **RETURN** again.

Insert the DOMINATOR cassette into the data cassette player, ensuring that it is fully rewound.

Hold down the **SHIFT** and **RUN/STOP** keys on the computer together. Then press the **PLAY** key on the data cassette player. The game should then load.

Refer to the multi-load instruction section of this Operation Manual.

- 2) If you are using your Commodore 64/128 with the disk version of DOMINATOR...

Connect your disk drive to your computer and switch the disk drive, computer and TV/monitor on. C128 owners should now select C64 mode by typing GO64, pressing **RETURN**, then **Y**, then **RETURN** again.

Insert the DOMINATOR disk into the disk drive, label side up. Now type **LOAD***,8,1** and hit **RETURN**. The game should then load.

Refer to the multi-load instruction section of this Operation Manual.

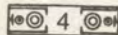

- 3) If you are using your Amstrad CPC 464, 664 or 6128 with the cassette version of DOMINATOR...

Switch your TV/monitor and computer **ON**.

If your computer has a built-in disk-drive you should now connect a compatible cassette player to your computer. Then type 'I'tape and hit **RETURN**. Now your computer will be ready to load data from the tape. To obtain the 'I' symbol, press the SHIFT key and @ key together.

Insert the DOMINATOR cassette into the tape player. Ensure that the cassette label marked side one is facing upwards and that the cassette is fully rewound.

Press the **CTRL** and small **ENTER** keys together, then press the **PLAY** button on your cassette player. The game should then load.

Refer to the multi-load instruction section of this Operation Manual.

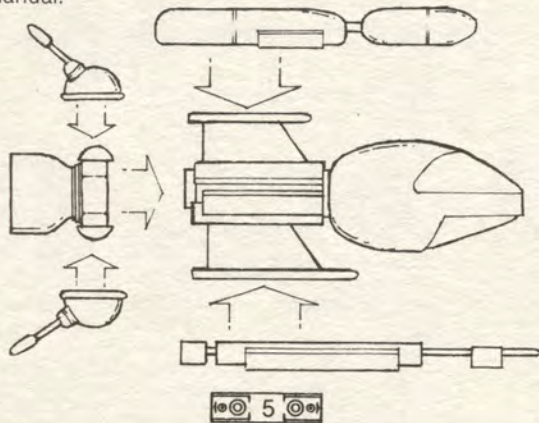

- 4) If you are using your Amstrad CPC 464, 664 or 6128 with the diskette version of DOMINATOR...

If your computer has a built in cassette player, first switch your computer OFF and connect a compatible disk-drive to your computer. Now switch the disk-drive and the computer **ON**. Then type " " disk and hit **RETURN**. Now your computer will be ready to load data from disk.

Insert the DOMINATOR diskette into your disk-drive, label side up.

Type **RUN" DISK"** then hit the **ENTER** key.

Refer to the multi-load instruction section of this Operation Manual.

- 5) If you are using your ZX Spectrum, Spectrum+, Spectrum 48K, Spectrum 128K, Spectrum +2 with the cassette version of DOMINATOR...

Connect your cassette player to your Spectrum as advised in the user manual.

As you are using a joystick insert the necessary interfaces **NOW**.

Switch your TV/monitor, cassette player and computer **ON**. If your Spectrum now displays a menu screen you may select with 48K or 128K Basic.

Insert the DOMINATOR cassette into the cassette player, with the cassette label marked side one facing upwards. Ensure that the cassette is fully rewound.

- 6) Type **LOAD** " " and then hit the **ENTER** key. Now press the **PLAY** button on your cassette player. The game should now load.

ATTENTION ALL SPECTRUM CASSETTE USERS!

When the game is loaded, press **STOP** on your tape recorder. When you have completed a load and have pressed the **YES** request, press **PLAY** on your tape recorder.

Refer to the multi-load instruction section of this Operation Manual.

If you are using your Atari ST, Amiga or Spectrum +3 with the diskette version of Dominator...

Connect your disk drive to your computer – if your computer features a built-in disk drive you will not have to do this. Insert the Dominator diskette into the disk drive, label side up. Switch your TV/monitor, computer and disk drive ON. For ST and Amiga users the game will now load automatically. Spectrum +3 users should then press RETURN and the game will load automatically.

Refer to the multi-load instruction section of this Operation Manual.

MULTI-LOAD INSTRUCTIONS

DOMINATOR is a multi-load game. Each level will be loaded as you complete the previous one. This means that to enjoy continuous play you **MUST** keep your DOMINATOR cassette in your data cassette player, or your DOMINATOR disk in

your disk drive, at all times during a session with the game. On screen prompts will appear when you complete a level, telling you what to do next.

When loading cassette versions of the game you will be prompted to turn over the tape, rewind fully and load the next level.

ATTENTION ALL CASSETTE USERS!

Because DOMINATOR is a multi-load game you may have some loading difficulties. If these problems continue please consult **System 3 Software on 01-866 5692**

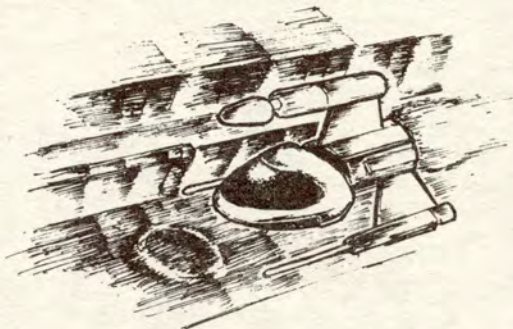

GENERAL INSTRUCTIONS

The movements of your spacecraft are controlled by up, down, and left and right movements of the joystick. Use the fire button to fire your weapons.

To begin your spacecraft is equipped with a pulse canon. Weaponary may be added to and bonus points collected by picking up or shooting at weapon/bonus icons. Picking up or shooting weapon icons results in the addition of one item from the following arsenal:

- REAR GUNS
- LASER
- BLASTER CANON
- AUTO FIRE

With the exception of Amiga and Atari owners each level is begun afresh i.e. without any additional weaponry or bonus items acquired in the previous level.

FOR SPECTRUM AND AMSTRAD OWNERS

You begin Dominator with 5 lives and 0 points: the game continues until all these lives are lost.

Weapon and bonus icons appear identically as metallic disks. Picking up or shooting one of these disks results randomly in the acquisition of additional weaponry listed in the GENERAL INSTRUCTIONS section or in one of the following bonus items:

- AN EXTRA LIFE
- A 1000 POINT BONUS
- THE ADDITION OF SMART BOMB WEAPONARY TO YOUR SPACECRAFT
- A 'CHEAT' MODE INDICATED BY YOUR SPACECRAFT TURNING RED

FOR COMMODORE OWNERS

You begin Dominator with 4 lives and 0 points: the game continues until all these lives are lost.

Weapon icons appear as 'gun pods'. You may also pick up or shoot one of the following bonus items:

EXTRA SPEED appears as a T shape contained in a diamond.

EXTRA LIFE for achieving the first 20,000 points; and for every 50,000 points thereafter.

500 POINT BONUS for hitting certain 'mystery' parts of the background.



D·O·M·I·N·A·T·O·R

FOR AMIGA AND ST OWNERS

You begin Dominator with 4 lives and 0 points: the game continues until all these lives are lost.

Weapon icons resemble the weapon you are picking up or shooting. Weaponary acquired is carried throughout the game from one level to the next with the exception of auto fire which is on a time limit and therefore needs to be continuously reacquired.

Bonus icons resemble a question mark and when picked up or shot reward you with one of the following:

AN EXTRA LIFE

BONUS POINTS

THE ADDITION OF SMART BOMB

WEAPONARY TO YOUR SPACE CRAFT.

