

SUBWAR 2050

THE UNDERWATER COMBAT SIMULATION



Game Manual

<http://www.replacementdocs.com>

SUBWAR 2050

THE UNDERWATER COMBAT SIMULATION



**Technical Supplement
for IBM PC Compatibles**

Contents

Your *SubWar 2050* package should contain a Game Manual, a copy of *UnderCurrents*, this Technical Supplement, a Key Guide, a set of 3.5" high density disks and a registration card.

Required Equipment

● Computer

SubWar 2050 requires an IBM PC AT or a computer 100% compatible with this model.

The computer must have a high density floppy disk drive and a hard disk.

SubWar 2050 requires an 80386 processor and at least 1Mb RAM.

● Controls

Although *SubWar 2050* can be run entirely from a standard or portable PC keyboard, a mouse and joystick are strongly recommended.

● Display

SubWar 2050 requires a colour monitor with a VGA graphics system. If you are using a compatible graphics card/monitor, it must be 100% compatible with VGA systems.

● Disk Drives

SubWar 2050 must be installed onto a hard disk with 12Mb of free space.

● DOS

You must have IBM PC-DOS or Microsoft MS-DOS version 5.0 or higher.

Copy Protection

SubWar 2050 has no disk copy protection. However, the program asks you a manual-related question. Use the manual to answer the question. MicroProse regrets that continuing casual and organised software piracy requires that this minimal form of copy protection is retained.

Installation

An installation program is included on the *SubWar 2050* Disk A.

Insert Disk A into your floppy drive (drive A or B) and designate that drive (by typing "A: [Return]" or "B: [Return]").

When the new prompt appears, type "INSTALL [Return]"

Please follow the on-screen text which appears.

The default (pre-set) installation routine places *SubWar 2050* in a directory named C:\MPS\SUBWAR

Loading Instructions

Switch on your machine and wait until the C:\> prompt appears.

Type "CD MPS\SUBWAR [Return]" and then type "SUBWAR [Return]" to run the game.

Note: If you have installed *SubWar 2050* to another directory, you must type "CD [name of your directory]" first.

If the game fails to load, read the Problem Section of this Technical Supplement.

Sound

SubWar 2050 supports the PC internal speaker, AdLib compatible cards, SoundBlaster compatible cards and the Roland LAPC-1 card.

Operating Difficulties and Loading Problems

Q. Why can't I install the game to my hard disk?

1. You must check all system requirements, especially any mention of hard disk space required, listed in this Technical Supplement.
2. If you still have a problem, you should make copies of the original disks and use the duplicates in place of the originals; sometimes you'll get a read error due to a difference in head alignment.
3. If the game still doesn't work, make sure you are not running a compression utility program on your hard disk.
4. Finally, try installing the game on another machine to see if the problem recurs.

Q. How do I copy disks?

From the C:\> prompt, use the DOS command DISKCOPY A: A: [Return]. Follow the on-screen prompts.

Q. Why won't my game load?

You must have 611,000 bytes (596K) of Conventional Memory and 10K UMB (Upper Memory Block).

To check that you have allocated an upper memory block, look for the line DOS=UMB (MS-DOS 6) or DOS=HIGH,UMB (MS-DOS 5) in your PC's CONFIG.SYS file.

Slow Running

If you are not running from a boot disk, please ensure that you have SMARTDRV.SYS or SMARTDRV.EXE loaded into your CONFIG.SYS or AUTOEXEC.BAT.

Conventional Memory

To check how much Conventional Memory is available, type MEM/C from the C:\> prompt and press the Return key. Look for the Largest Executable Program details. If there is not enough Conventional Memory, you may need a Boot Disk.

Q. What is a Boot Disk?

This is a Start Up disk for your computer which contains alternative start up files to those on your hard disk. The Boot Disk will allow you more Conventional Memory.

Making a Boot Disk

Instructions for making an MS-DOS Boot Disk (also known as a System Disk) will be found in your Microsoft manual.

Using a Boot Disk

Insert the Boot Disk into your floppy disk drive A and then switch on the computer. You should leave the disk in the floppy drive during play.

Q. Can I run my game through Windows?

No, this is not recommended, unless specifically mentioned in the system requirements.

Q. Does my game run with DR DOS?

Success is not guaranteed. MicroProse games are currently designed to run with MS-DOS 5.0 or 100% compatible DOS.

Q. What is Base Memory?

This is the original 1Mb (1024K) in your machine. It is divided up into Conventional Memory (640K), where MS-DOS and all PC programs load and Upper Memory (384K), where system drivers (such as the mouse driver) reside.

In MS-DOS 5.0 the bulk of the operating system and associated drivers are normally loaded into Upper Memory. Other drivers held in the area of Conventional Memory will reduce your 640K available for the program.

Q. What is Extended Memory (XMS)?

Further memory, beyond the 1Mb of Base Memory on your PC is called Extended Memory. XMS can be used to free more Conventional Memory so that bigger games can be run. XMS can also be used to simulate Expanded Memory.

Q. What is Expanded Memory (EMS)?

EMS was originally designed to give the PC more memory to run programs. It has been around far longer than XMS so most programs take advantage of it. Most MicroProse games take advantage of EMS. The DOS command EMM386.EXE can be used to turn XMS into EMS and should be in your CONFIG.SYS.

Remember that hard disk space is also measured in Megabytes (Mb). Don't confuse this with memory - the two are completely different!

Technical Assistance

If you have read through the Problems Section of this technical supplement and still experience difficulties with the game, you may need some help from us. As we receive many calls every day, we can deal with your enquiry more efficiently if you have the following information available:

1. The correct name of the game
2. The type of computer you are running it on
3. Your DOS version
4. How much *conventional memory* you have
5. The exact error message reported (if any)
6. The version # of the game

Ring us on 0454 329510, Monday to Friday 0900 to 1700 hours. Have a pen and paper handy when you call. Alternately, you can write to Customer Services at the address shown in this document.

Virus

Be aware that a virus may have transferred into your hardware from another piece of software. Pirated copies of games are an incredibly common source of virus problems. It always pays to own original software.

Software Fault

In the unlikely event of a software fault please return the complete package, with your receipt, to the **place of purchase**. MicroProse regret that goods cannot be replaced unless bought from the company directly.

The Read Me File

The latest notes regarding this program, additions, revisions etc can be found in a file named README.TXT in the SUBWAR directory. These notes may be read by using either standard DOS commands or the DOS 5.0 text editor (type EDIT README.TXT).



MicroProse Ltd. The Ridge, Chipping Sodbury, Avon BS17 6AY
Tel: 0454 329510

Game Design and Program Copyright ©1993 Particle Systems
Documentation, Packaging and Logo Copyright ©1993 MicroProse Ltd

This documentation, accompanying manuals and floppy disks are copyrighted. The owner of this product is entitled to use this product for his or her personal use. Except for back-up copies of the disks for personal use and the quoting of brief passages for the purposes of reviews, no one may transfer, copy, back-up, give or sell any part of the manual or the information on the disks, or transmit in any form or by any means, electronic, mechanical, photocopying, recording or otherwise without the prior permission of the publisher. Any person or persons reproducing any part of this program, in any media, for any reason, shall be guilty of copyright violation and shall be subject to civil liability at the discretion of the copyright holder.

Made in the UK

MP122153T/SR

SUBWAR 2050

THE UNDERWATER COMBAT SIMULATION

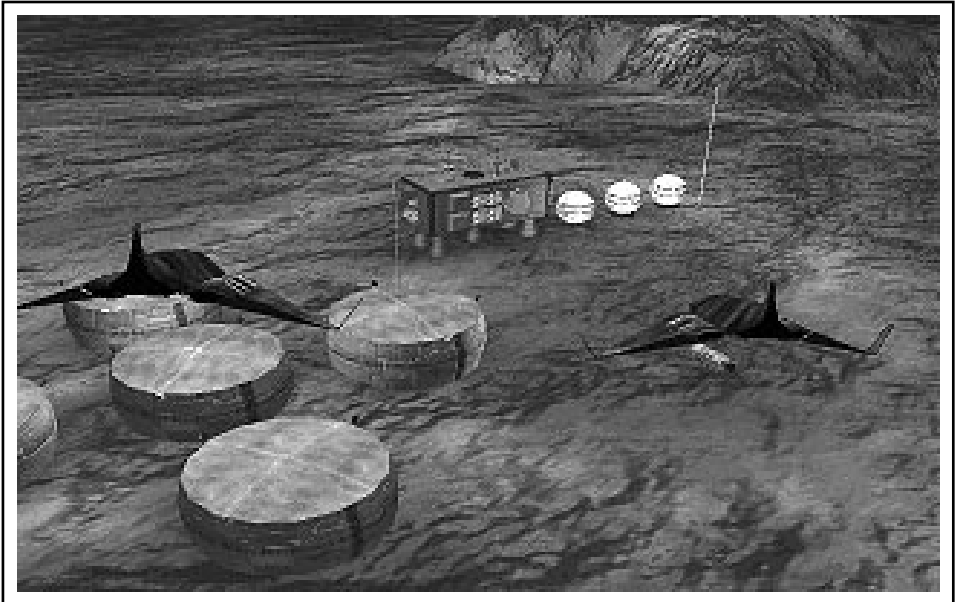

MicroProse Ltd. The Ridge, Chipping Sodbury, Avon BS17 6AY
Tel: 0454 329510

Game Design and Program Copyright ©1993 Particle Systems
Documentation, Packaging and Logo Copyright ©1993 MicroProse Ltd

This documentation, accompanying manual and floppy disks are copyrighted. The owner of this product is entitled to use this product for his or her personal use. Except for back-up copies of the disks for personal use and the quoting of brief passages for the purposes of reviews, no one may transfer, copy, back-up, give or sell any part of the manual or the information on the disks, or transmit in any form or by any means, electronic, mechanical, photocopying, recording or otherwise without the prior permission of the publisher. Any person or persons reproducing any part of this program, in any media, for any reason, shall be guilty of copyright violation and shall be subject to civil liability at the discretion of the copyright holder.

Made in the UK

CREDITS

Game Design & Programming	Michael Powell for Particle Systems
3-D Shape Design	Saul Markese Michael Powell
Additional Shape Design	Amanda Roberts Kevin Ayre
Graphics and Animations	Mark Scott Eddie Garnier
Additional Graphics	Martin Smillie
Mission Design	Mike Brunton
Music and Sound Effects	Matthew Walden
Quality Assurance Management	Peter Woods
Quality Assurance Testing	Andrew Luckett Darren Kirby James Hawkins Andrew Hieke Peter Moreland
Documentation	Kristian Ramsay-Jones
Packaging Design	Julie Burness Sarah Warburton
Game Manual Design	Sarah Kerr
<i>Undercurrents</i> Design	Sarah Warburton
Managing Editor	Alkis Alkiviades
Product Marketing Manager	John Davis
Producer	Tim Roberts
Publishers	Paul Hibbard Peter Moreland

Special Thanks to Peter Hunter at the Institute of Oceanographic Studies for Undersea Topological Data.

CONTENTS

Introduction	5
The Manuals	5
Controls	6
The Controller	6
The Selector	6
Getting Started	7
Sorting the Materials	7
Installing/Loading <i>SubWar 2050</i>	7
Copy Protection	7
The Command Centre	8
New Campaign	9
Quit	9
Game Options	10
Simulated Combat	12
Pilot Roster	12
Mission Briefing	13
The Orders	14
The Mission Map	14
The 3-D Briefing	15
Configure Subs	16
The Configuration Screen	16
The Arming Screen	17
Enter Mission	17

CONTENTS

The Mission.....18

Piloting Your Submarine.....18

 Primary Controls18

 The 3-D Display.....19

 The Head-Up Display.....20

 The Cockpit Displays22

 Full-Screen Displays26

 Other Controls27

Views28

 Cockpit Views28

 External Views28

Returning to the Sub Carrier29

Mission Debriefing30

INTRODUCTION

SubWar 2050 is a unique simulation. It combines elements of submarine warfare, flight simulation and strategy game; set in a realistic future world scenario.

You take the part of one of the new breed of submariners, piloting the latest in marine technology; the fighter sub. Working for huge corporations as an independent mercenary, each mission you carry out is rewarded in hard cash.

One moment, you are battling using tactics which are drawn from air warfare. The next, you are diving deep to reduce your cavitation and coming to a halt to reduce your passive sonar visibility.

Varied missions in four theatres of war, simulated combat mode and a full complement of training missions make *SubWar 2050* the definitive underwater combat simulation.

The Manuals

This manual is organised to help you start playing *SubWar 2050* quickly:-

The section on **The Command Centre** will introduce you to the different levels of play in *SubWar 2050*.

The section on **The Mission** explains how to operate your sub's control, navigation and combat systems.

The separate *UnderCurrents* manual contains information which may be useful as you get deeper into the game.

Controls

The Controller

You can play *SubWar 2050* using a combination of Keyboard, Mouse or Joystick. For piloting submarines, it is recommended that you use a Joystick and for menu selection it is recommended that you use a Mouse.

In this manual, which is applicable to all computer systems, these three devices are known as the *Controller*.

The Selector

During the game, you may be asked to select from a list of options. You will be able to use either the Keyboard Return/Enter key, the Left Mouse Button (abbreviated to LMB) or the Joystick Fire Button.

In this manual, these devices are referred to as the *Selector*.

GETTING STARTED

Sorting the Materials

Your *SubWar 2050* package contains this Manual, a copy of *UnderCurrents*, a Technical Supplement, a Key Guide and a set of disks to run the simulation.

Installing/Loading *SubWar 2050*

The Technical Supplement gives specific instructions for installing and/or loading *SubWar 2050* for your particular computer.

Copy Protection

After the opening screens, you are taken to the Copy Protection screen. Enter the correct word from the manual using the reference given.

When you have completed the Copy Protection, you are transferred to The Command Centre, on board the sub carrier.

THE COMMAND CENTRE

The Command Centre is the central room of your sub carrier. The Command Centre screen contains a number of options which are accessed by moving the Cursor over an 'active' area of the screen and pressing the *Selector*.



When you move the cursor over an 'active' area of the Command Centre, its function is displayed in the box at the top centre of the screen.

New Campaign



Select 'New Campaign' to begin a new campaign. You may choose from:-

- | | |
|-----------------------------------|--------------------------------------|
| North Pacific | - Training |
| Antarctica | - The Hot Cold War |
| North Atlantic | - The Treasure Trove |
| South China Sea | - Trouble in Paradise |
| North Pacific/Sea of Japan | - Small Insults, Big Business |

The training campaign is recommended for rookie sub pilots. Each of the other four scenarios have their own unique challenges and may be played in any order.

Click on the  icon to change the current campaign. You may change your current campaign at any time; the position reached in your previous campaign will be saved.

Click on the  icon to view the scenario briefing text.

Click on the  icon to return to the Command Centre.

Quit

Select 'Quit' to exit *Subwar 2050* and return to your computer's operating system.

Game Options



Select 'Game Options' to make game configuration changes. To change a particular game option, click on the  icon.

Click on the  icon at the bottom of the Game Options screen to return to the Command Centre.

Calibrate Joystick

Select this option to calibrate an analogue joystick.

Control Mode - Mouse/Joystick/Keyboard

Select this option to change the submarine control mode.

Terrain Shading - Textured/Plain/Wireframe

Select this option to change the 3-D terrain shading mode - fully textured terrain can slow the frame update rate significantly, especially on slower machines.

Object Shading - Textured/Plain/Wireframe

Select this option to change the 3-D object shading mode.

Collisions - On/Off

Selecting 'Collisions Off' prevents your submarine from sustaining damage if it hits the seabed or another submarine.

Selecting 'Collisions On' is more difficult to play, but will result in a higher mission score.

Sonar Realism - Realistic/Simplified

During real underwater engagements, the only way of seeing stationary enemies is to use your active sonar. However, this has the disadvantage of broadcasting your position to the enemy.

The 'Simplified' sonar realism setting allows you to see all submarines within a range of approximately 1 kilometre. This is unrealistic, but makes the game easier to play. However, while you can see the enemy, you cannot target them until they are detected by your active or passive sonar.

The 'Realistic' sonar realism setting will only display those submarines which your active or passive sonar has detected. Playing on this setting is more difficult, but will result in a higher mission score.

Enemy Skill Level - High/Medium/Low

The enemy skill level affects the intelligence, aggressiveness and number of opponents you encounter during a mission.

Playing on a high skill level will result in a higher mission score.

Screen Zoom - On/Off

Select 'Screen Zoom off' to turn off the zoom effect between screens.

Simulated Combat

Selecting 'Simulated Combat' puts you into a fighter sub simulator, in the middle of a multi-sub underwater dogfight. 'Simulated Combat' allows you to perfect your underwater combat technique without getting killed.

The score which you get at the end of a 'Simulated Combat' session is dependent on several factors, including how many enemy subs you destroy and the number of weapons it took to destroy them.

For more details on piloting submarines, see the section of this manual on 'The Mission'.

Pilot Roster



The Pilot Roster screen allows you to select or create a pilot.

If you wish to play a different pilot, click on one of the eight numbered icons along the bottom of the pilot status display. If the pilot is unavailable for action, they are listed as either 'KIA' (Killed In Action), 'MIA' (Missing In Action) or 'Captured'.

If you want to create a new pilot, click on one of the eight numbered icons to select the pilot you wish to delete, then click on the  icon. Type in the new pilot's name using the keyboard and press RETURN. The default campaign for new sub pilots is 'Training'. Return to the Command Centre and enter the 'New Campaign' screen if you wish to select a different campaign.

If you wish to change the face of the selected pilot, click on the  icon.



Click on the  icon to view the selected pilot's medals and awards.

Click on the  icon to return to the Command Centre.

Mission Briefing

When you have created or selected a pilot in the Pilot Roster and you have selected a campaign, you are able to enter the Mission Briefing.

The Mission Briefing consists of three screens:-

- the Orders - click on the  icon.
- the Mission Map - click on the  icon.
- the 3-D Briefing - click on the  icon.

Click on the  icon to return to the Command Centre.

The Orders

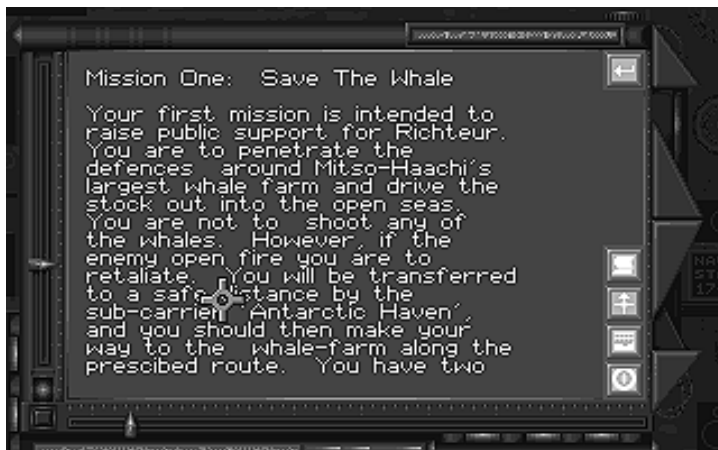

The Orders screen consists of a brief description of the mission's objectives, rules of engagement and intelligence data on enemy activity. To view the next page of the Mission Briefing, click on the  icon.

The Mission Map







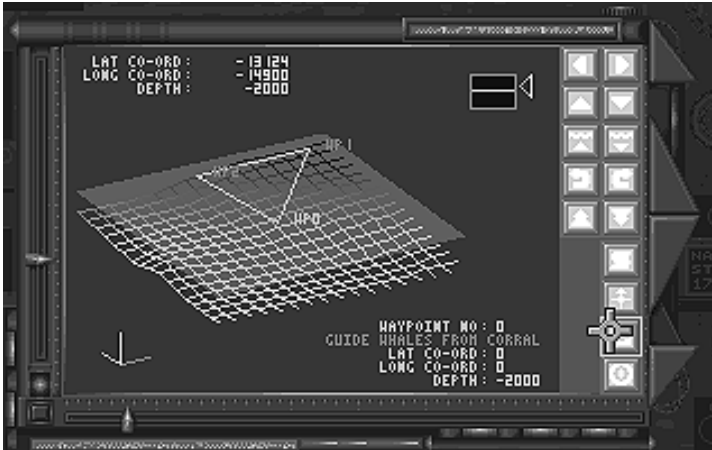





The Mission Map is a top-down view of the mission area. You may also call up a Mission Map when you are in the cockpit of your submarine.

The 3-D Briefing



The 3-D Briefing augments the Mission Map by providing a 3-D view of the mission area. Additional data is provided on this screen concerning the depth of the mission waypoints.

The 3-D view may be manipulated by using the ten icons in the top right of the 3-D briefing screen:-

- Select the  or  icons to move the display West or East.
- Select the  or  icons to move the display North or South.
- Select the  or  icons to move the display up or down.
- Select the  or  icons to rotate the display to the right or left.
- Select the  or  icons to tilt the display forward or backward.

Configure Subs



When you have completed your Mission Briefing, you may enter the 'Configure Subs' screens. This consists of two displays:-

- the Configuration Screen
- the Arming Screen

The Configuration Screen



This is the first screen in the 'Configure Subs' section. It consists of a 3-D display of the sub(s) you are taking on your mission and their payload, orders, type and formation position.

Click on the  or  icons to select the next/previous sub. The selected sub is highlighted with a pair of yellow brackets.

Click on the  icon to change the highlighted sub's position in the formation.



Click on the  icon to change the highlighted sub's orders.

Click on the  icon to enter the Arming Screen.

The Arming Screen



This screen allows you to adjust the payload of your sub to suit your particular tactics or skill level. For example, when you have become a proficient sub pilot you might prefer to take rockets on a mission instead of torpedoes.

Click on the  or  icons to select the next/previous weapon bay. The selected weapon bay is highlighted with a yellow box.

Click on the  icon to load more of the selected weapon onto your sub.

Click on the  icon to unload the selected weapon from your sub.

Click on the  icon to return to the Command Centre,

Enter Mission

When you have configured your submarines, click on the bottom right-hand monitor to begin your mission.

THE MISSION

Piloting Your Submarine

You begin most missions under the submarine carrier, moments after launching.

Primary Controls

Submarine controls are split into three different groups -

Directional Controls which allow you to turn, dive and climb.

Engine Controls which allow you to control your speed.

Ballast Tank Controls which provide additional control over depth. These controls may also be used when you are stationary, hiding from passive sonar.

Directional Controls

Joystick

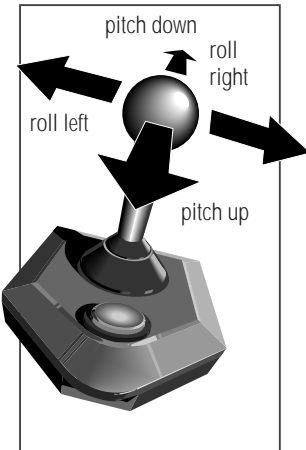

Keyboard

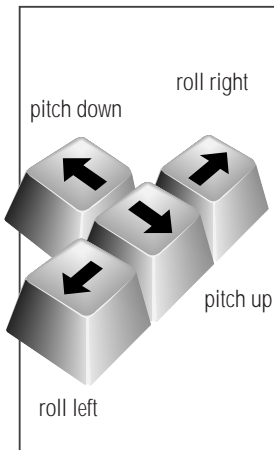

Mouse

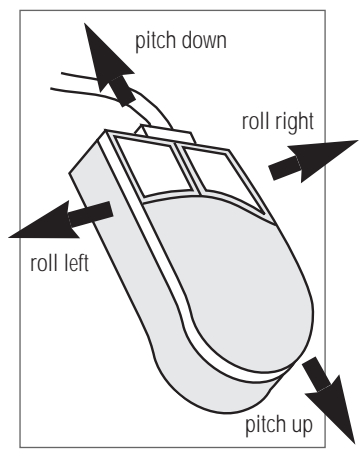

Press **L** to lock your submarine into single-plane manoeuvring. With this function on, moving the controller to the left or right will make the sub turn in that direction with no change in its roll angle. Single-plane manoeuvring is useful when you are lining up on targets and when you are running on the surface.

Engine Controls

+	Increase throttle
-	Decrease throttle
shift -	Set throttle to minimum power
[Set throttle to 1/3 power
]	Set throttle to 2/3 power
shift +	Set throttle to maximum power

Ballast Tank Controls

8	Flood ballast tanks
9	Flood/blow ballast tanks to remain at current depth
0	Blow ballast tanks

Note: If you want to dive or climb really fast, combine the dive controls with the engine controls.

The 3-D Display

It is too dark to navigate a submarine visually at depths below about 200 feet. For this reason a 3-D seafloor display, generated from seafloor survey data, is projected onto the inside of your sub's cockpit. This 'virtual world' display is also used to show your opponents' submarines via active sonar imaging.

The Head-Up Display

The Head-Up Display is overlaid on the 3-D display and shows the following data:-

Artificial Horizon

When your sub is not at a high nose-up or nose-down angle, you will be able to see the artificial horizon bar. This is displayed on the HUD as a short red line, allowing you to see if your sub is in a level attitude.

Waypoints

When you reach a waypoint, it will be displayed on your HUD as a green triangle. If you fly through the centre of this triangle, your sub's navigation system will automatically switch to track the next mission waypoint.

Thermal Layers

Thermal layers are boundaries between warm and cool water which are set up by ocean currents. They are very important to sub pilots because they reflect sonar just like a mirror reflects light. If you position your sub with a thermal layer between it and the enemy, you will be invisible to their sonar.

Thermal layer boundaries may be one of two types:-

From warm to cool water - displayed on your HUD as a green grid.

From cool to warm water - displayed on your HUD as a red grid.

Thermal layers are also useful to orientate yourself. For example, if you are upside-down you will see red thermal layers below you.



Targeting

When your sonar detects an object, it will mark it with a box on the HUD. The currently targeted object is marked with a diamond-shaped box, all other contacts are marked with square boxes. The HUD targeting display also presents the following target information:-

- the object's distance from the nearest thermal boundary. This is represented by a line extending vertically from the sonar contact to the thermal boundary. If there is no thermal boundary nearby, this line will not be displayed.
- target type, which may be one of the following:-
 - SUB - a submarine
 - BIO - a marine lifeform
 - SHP - a ship
 - HLI - a helijet
 - TRP - a torpedo or rocket
 - MNE - a mine or depth charge
 - TRN - a transponder
 - DCY - a decoy
 - STR - a structure such as an underwater base
 - DBR - underwater debris
 - UNK - unknown
- target rating, denoted by the colour of the tracking box:-
 - Blue - friendly object
 - Red - enemy object
 - Green - neutral or unknown object

The Head-Up Display may be toggled on or off by pressing H.

The Cockpit Displays



The cockpit display consists of four large screens, augmenting the 3-D display and the HUD. There are also two small displays for instant assessment of your detectability and damage status.

Navigation Display

The Navigation Display has two modes; **Waypoint** and **Map**. Press **M** to toggle between these two modes.

In **Waypoint** mode, the Navigation Display lists the following information:-

- WAYPT** - waypoint currently being tracked by the navigation system.
- BEARING** - the bearing along which you must travel to reach the waypoint.
- RANGE** - the distance to the waypoint.
- DEPTH** - the depth of the waypoint.
- TIME** - the elapsed mission time (you will be told in the briefing if you have a set time to complete the mission).
- CLRNC** - the clearance between the seabed and your sub. If you get within 100 feet of the seabed, this readout will change from yellow to red.

In **Map** mode, the Navigation Display shows a map of the immediate terrain with your sub in the centre. As on the HUD, all objects are colour coded:-

- Yellow - your sub
- Blue - friendly object
- Red - enemy object
- Green - neutral or unknown object

Instruments

The Instruments consist of three rows of figures:-

The top line shows your current heading in degrees. The direction you must turn to reach the currently selected waypoint is also shown, as arrows to either side of the heading readout.

The second line shows the speed of your sub in knots, followed by your throttle setting (between 0 and 120).

The last line shows your current depth in feet.

Targeting Display

The targeting display gives a readout of data concerning the currently targeted sonar contact. To change the currently targeted sonar contact, press τ .

- CONTACT** - the number of the currently targeted contact followed by the total number of sonar contacts.
- TYPE** - the type of contact (e.g. SUB - a submarine). This may change as your sub gets closer to a contact and identifies it more positively.
- RATING** - the target's rating (friendly, enemy, unknown).
- BEARING** - the bearing which you must follow to reach the contact.
- COURSE** - the course which the contact is following.
- SPEED** - the speed at which the contact is travelling.
- RANGE** - the distance from your sub to the contact, in nautical miles.
- CONF** - the confidence factor of your submarine's weapon systems in hitting the targeted object with an active homing torpedo. Confidence factors are based on many separate considerations including the time the object has been tracked for and the amount of noise it is making. Confidence factors in excess of 100 are required to guarantee a hit.

Note: if a torpedo is fired at you, it will be targeted automatically to give you the maximum chance of avoiding it. By making maximum use of the external views, you should be able to anticipate the torpedo's manoeuvres and outsmart it.

Weapon Display

The Weapon Display allows you to see what weapons you have selected and how many are remaining.

The top line of the display shows which weapon bay is selected. To change the selected weapon bay, press **B**.

The second line of the display shows the weapon carried in the selected bay and number of these weapons remaining. To fire a weapon, press **X**.

The third line of the display is the weapon status. This can be one of the following:-

- READY** - the selected weapon is ready to be launched
- ARMING** - the selected weapon has just been launched and is arming itself
- EMPTY** - the selected weapon bay is empty
- DAMAGED** - the weapon systems are damaged

The final line of the Weapon Display is the sonar status. Press **S** to change your sub's sonar mode. You may choose between:-

- OFF** - sonar systems off
- PASSIVE** - passive (listening) sonar on
- ACTIVE** - active (echo) sonar on

If an enemy torpedo is launched at you, press **D** to release a decoy, then carry out a hard turn. This should allow you to escape unscathed.

Sonar Cross-Section (SCS) Display

The SCS Display is a bar scale running from left to right which allows you to see the amount of noise you are making. If the display is black, you are completely silent. If it is yellow, you are making some noise and you risk enemy detection. If it is red, you are broadcasting your position to everyone in the immediate vicinity. To keep your noise level down, you must run slowly and use active sonar with extreme care.

Damage Status

The eight bars below the SCS Display represent the status of your sub's primary systems. The bar scale is entirely green if the system is undamaged, yellow if partly damaged, red if heavily damaged and black if destroyed. See **Damage Status** in the next section for full details.



Full Screen Displays

Map Screen

Press 1 to enter the mission map. This is similar to the Mission Map in the Command Centre, but has some additional functions:-

Click on the  icon to increase the map magnification.

Click on the  icon to decrease the map magnification.

Click on the   icons to toggle the auto-centring function on or off. Auto-centring keeps your sub at the centre of the map display at all times.

Click on the  icon to return to your sub's cockpit.

Damage Status Screen

Your sub is equipped with a complex network of damage assessment and automatic repair systems. Press 2 to enter the screen which controls these systems; the Damage Status screen.

The Damage Status screen allows you to assess your current damage status and modify your sub's automatic damage repair systems to repair important systems first.

In the bottom of the Damage Status screen, there is a list of your sub's primary systems. These include such items as Hull Structure, Weapon Systems and Sensor Systems.

For each primary system, there is a display consisting of, from left to right:-

- the name of the system.
- a bar chart which shows the damage status. This is green if the system is fully operational, yellow if partly damaged, red if heavily damaged and black if destroyed.
- a brief description of the repair state. This may be:-

OPERATIONAL	- the system is fully operational
UNDER REPAIR	- the system is under repair
MINOR DAMAGE	- the system has suffered minor damage
MAJOR DAMAGE	- the system has suffered major damage
DESTROYED	- the system is beyond repair

To select a particular damage system, click on the  or  icons.



To make this system the priority system to repair, click on the  icon. Repairs will now be made to this system before all others.

Click on the  icon to return to your sub's cockpit.

Wingman Orders Screen

You will need to give orders to your wingmen during missions. Press 3 to display the Wingman Orders Screen.

The Wingman Orders screen consists of a 3-D display of the sub(s) on your mission and their type, damage status, orders and formation position.



Click on the  or  icons to select the next/previous sub. The selected sub is highlighted with a pair of yellow brackets.

Click on the  icon to change the highlighted sub's position in the formation.

Click on the  icon to change the highlighted sub's orders.

Click on the  icon to return to your sub's cockpit.

Object Viewer Screen

Press 4 to enter the Object Viewer; a reference library of 3-D images. You may wish to consult this library to review the shapes of enemy vessels before engaging the enemy. Click on the  or the  icon to view the next/previous object. Click on the  icon to return to your sub's cockpit.

Other Controls

Press **shift E** to activate your submarine's ejection capsule.

Press **shift A** to accelerate the passage of time.

Press **P** to pause the game.

Press **shift Q** to either end or abort the current mission and return to the Control Centre.

Press **`** to display the 'Game Options' screen, allowing you to make game configuration changes mid-mission

VIEWS

Cockpit Views

When you are in the cockpit, you may move your viewpoint to the left, right, up and down:-

< moves the view to the left

/ moves the view to the right

> re-centres the view

; moves the viewpoint up or down, allowing you to see more or less of the 3-D world

2 or v hides the cockpit completely, displaying full-screen 3-D

External Views

Flypast Camera View - Press 3

- a stationary viewpoint which tracks your sub as it goes past.

Chase Camera View - Press 4

- a view which follows your sub from just behind, allowing you to see all around it. This view is very useful when manoeuvring in a restricted space.

Weapon Camera View - Press 5

- a view looking out of the nose of the last weapon you fired.

Tactical View - Press 6

- tracks the currently targeted sonar contact in the background with your sub in the foreground and is a very useful view in underwater dogfights.

Inverse Tactical View - Press 7

- tracks your sub in the background with the currently targeted sonar contact in the foreground and is useful for seeing what the enemy is doing in an underwater dogfight.

Current Contact View - Press 8

- a view through the nose of the currently targeted sonar contact, allowing you to see if it is lining up on you. This is a very useful view when you have targeted a hostile torpedo.

Returning to the Sub Carrier

When you want to land back aboard the sub carrier, you must bring your sub into a position immediately below the carrier's hangar. The carrier's automatic docking system will then pilot your sub into its hangar bay. Press **S Q** to end the mission.

MISSION DEBRIEFING

When you have completed your mission, you will be taken to the mission debriefing screen. The debriefing presents a summary of the mission and you are paid depending on your mission performance.

If you achieve an outstanding result in your mission, you may qualify for an award from either the mercenary's union or the company who you are currently working for.

To get a mercenary award, it is only necessary to score high points on the mission. To get a more valuable Corporate Award, you must carry out the mission objectives with maximum damage to the enemy and minimum damage to friendly forces, using the minimum amount of weapons (and therefore money).

You may review your medals and awards by selecting **Pilot Roster** in the Command Centre.

NOTES

NOTES