

TRI-M™

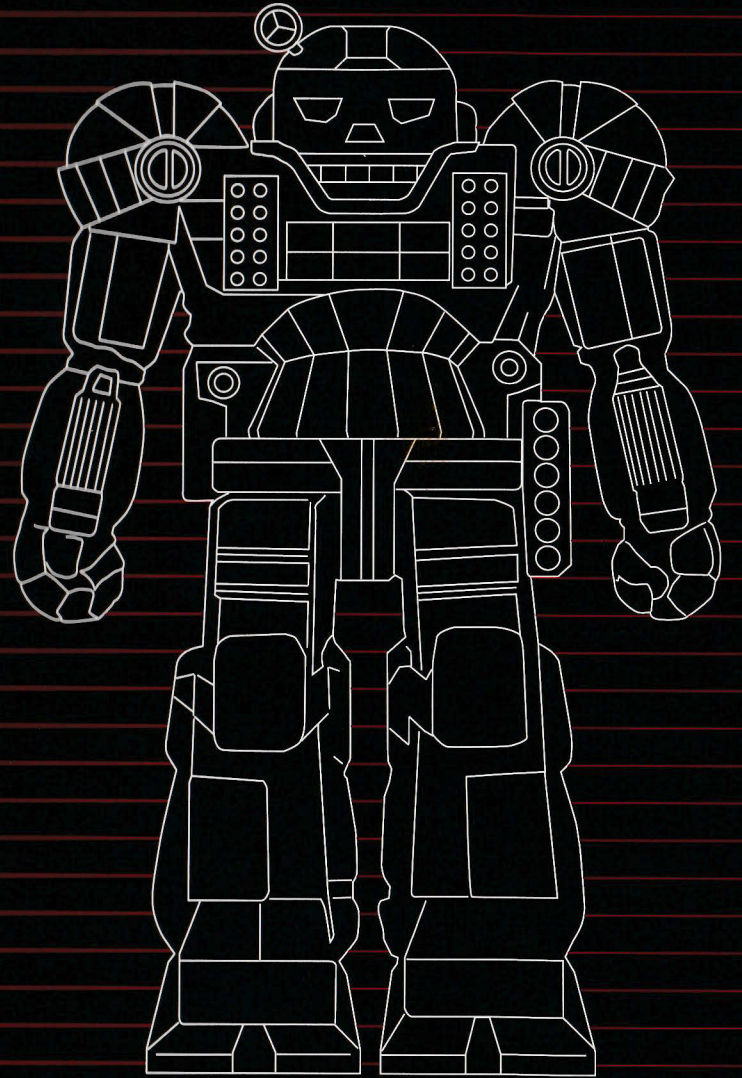

ACTIVISION®

FASA  
CORPORATION

Activision is a registered trademark of Activision, Inc. © 1996 Activision, Inc. MechWarrior, BattleTech, BattleMech and 'Mech are registered trademarks and MechWarrior 2: Mercenaries, MercNet, and Tri-M are trademarks of FASA CORPORATION. © 1996 FASA CORPORATION. All rights reserved.

CD2-3580-260-U3

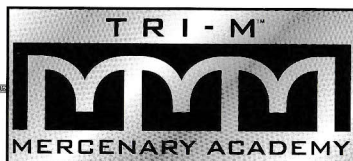

Dear Prospective Cadet:

As President and Founder of the Tri-M™ Mercenary Academy, people often ask me just what Tri-M™ stands for. I tell them *money, money, money*. Becoming a Mercenary was the best business decision I ever made. And it will be for you, too.

Twenty years ago, I was just like you -- sitting on some backwater low-tech rock where I only read about the big 'Mechs and the big money. What could I do? Join the military? Sure, and risk my life to line some general's pockets? I don't think so. Hey, they wouldn't have taken me anyway.

I had to smuggle my way onto a freighter on its way here to Outreach and cheat and steal my way into the Wolf's Dragoons. Two decades later, I'm a millionaire 30 times over, and you can be too -- but while I had to kill and scrape to get where I am, you don't have to! For a reasonable fee (or a percentage of your lifetime earnings -- see p. 317 of tuition agreement), the Tri-M™ Mercenary Academy will teach you the skills you'll need to pilot a 'Mech and plan a successful mercenary career. Worried about getting in? Don't be -- your acceptance is guaranteed on receipt of tuition payment!

Last year, we placed 100% of the class of 3043 with mercenary groups. That's right, 100%! And what do they have to say about good old Tri-M™? Throughout this brochure we have shown what students and alumni have to say about their alma mater.

In the following pages, you will be introduced to Tri-M™'s instructors, the "best" MechWarriors the universe has to offer, who will walk you through the Academy's program. After this taste of the mercenary life, you'll never want to give it up.

Howard Hughes O'Grady  
President, CEO and Founder  
Tri-M™ Mercenary Academy



## TABLE OF CONTENTS

### BUSINESS MANAGEMENT

OFFICE .....	1
GUIDING A CAREER .....	2

### 'MECH OPS

'MECH BAY .....	3
Arms Merchant .....	3
'Mech Factory .....	3
Customize .....	3
Repair and Reload .....	3
Weapons Grouping .....	4
WEAPONRY .....	4
Energy Weapons .....	4
Missiles .....	4
Ballistic Weapons .....	4
Weapons Configurations .....	5
GUIDING A CAREER .....	6

### COMBAT PROCEDURE

STARPORT .....	7
ComStar Terminal .....	7
Board DropShip .....	7
BASIC BATTLEMECH PILOTING .....	8
Heat Management .....	8
Throttle .....	8
Steering .....	9
Torso Twist .....	9
Pilot Eye Control .....	9
HEADS-UP DISPLAY (HUD) SYSTEM .....	10
Radar System .....	11
Heading Indicator .....	11
Weapons Display .....	11
Altimeter .....	12
Throttle Indicator .....	12
Targeting Reticle .....	12
Targeting Brackets and Markers .....	12
Targeting Camera .....	12
Targeting Information .....	12
Off-Screen Targeting Indicator .....	13
Heat Tracking Indicator .....	13
Jump Thrust Indicator (JTI) .....	13
Multi-Function Display (MFD) .....	13
Objectives/Briefing Summary .....	14
NAVIGATION .....	14
NAV Points .....	14
Autopilot .....	15



Free Worlds League

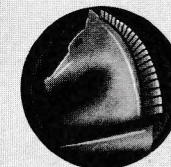

Lindon's Company

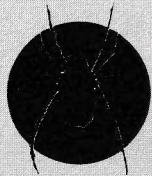

Black Widow  
Company

TARGETING .....	15
Targeting Info and Ranges .....	15
Target View .....	15
Inspection .....	16
DAMAGE AND CRITICAL HITS .....	16
ADVANCED PILOTING .....	17
Weapons Grouping .....	17
Jumping .....	17
Manual Shutdown .....	18
Pilot Auto-Ejection .....	18
Thermal Optics .....	18
Commanding a Lance .....	19
Commanding Aerospace Fighter Support .....	20
ENVIRONMENTAL CONDITIONS .....	20
Temperature .....	20
Atmosphere/Gravity .....	20
Terrain .....	20
Time of Day .....	20
GUIDING A CAREER .....	21
<b>Appendix A — BATTLETECH HISTORY .....</b>	<b>22</b>
<b>Appendix B — CONTROL SYSTEMS .....</b>	<b>23</b>
<b>Appendix C — WEAPONS .....</b>	<b>26</b>
<b>Appendix D — BATTLEMECH COMPONENTS ..</b>	<b>30</b>
<b>Appendix E — MERCNET .....</b>	<b>33</b>
<b>CREDITS .....</b>	<b>42</b>



*"Mercenary life is great. I make my own hours. I don't have to suck up to a boss, and I get to tour the galaxy. It's like being a really violent traveling salesman."*

— Daniel De Fabio, Tri-M™ Graduate

## BUSINESS MANAGEMENT

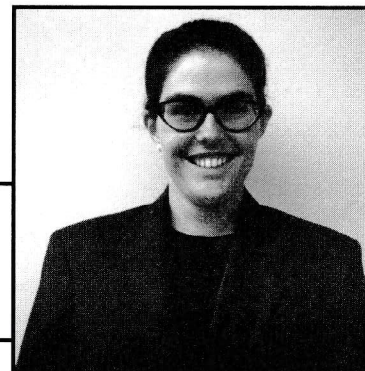

**Anya Kiowa**

Financial Expert

*"Get the skills to pay the bills."*

Here at Tri-M™, we don't just teach you how to fight — we teach you how to fight for *money*. That's where I come in. Before hiring on at the Academy, I was a junior partner in a major business consortium. Then I learned where the *real* money was and joined up with the Hansson's Roughriders. Now I'll teach you the business secrets I learned along the way. The first section of this manual will give a brief overview of what cadets learn in our business management program.

### OFFICE

This is the standard base of operations for a Mercenary, where you will find your computer, your most important tool in keeping track of your money, contracts and inventory.

**Contracts** — The Contracts Screen shows the contracts your mercenary team is being offered, and on what terms. You must always weigh your fee against the risks of the mission and the damages you may incur during it.

**Personnel** — Allows you to choose 'Mech pilots so that you can assemble a well-balanced, compatible team that is *with-in your means*. When choosing personnel, keep in mind that you also have to purchase 'Mechs and equipment. Also, you can hire aerospace pilots who offer the added protection of air support while you are in combat.

**Inventory** — Shows all your 'Mechs, weapons and ammunition. There are two ways to acquire items for your inventory. 'Mechs and equipment can be purchased in the 'Mech Bay, or they can be salvaged as bounty during missions.

**Finances** — Mercenary contracts can make you a *lot* of C-Bills, but remember that everything costs money: 'Mechs, weapons, pilots, repairs and ammunition. The Finances

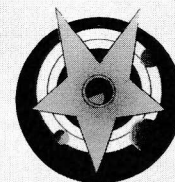

12th Star Guards



Screen helps you keep track of your total funds and your monthly expenses.

### GUIDING A CAREER

H.H. also asked each of us if we would say a few words about how to steer a mercenary career successfully. My colleagues might say differently, but, in my opinion, the most important part of your job is picking the right contracts. Always weigh your potential gains against your potential losses. Be aware of who your employer is, who your enemy is in each mission, and what kind of resistance you can expect. You can always find out background info from ComStar news in the Spaceport, which will inform you a little better when choosing between contracts.

Here my area of our tour ends, but I want to stress again that the financial aspects of a Merc's career are truly among the most important. I mean, what are we in this for? Excitement? Honor? *Please*. During the rest of your tour, and if you join us here at the Academy, always pay attention to how much things cost, especially 'Mechs, weapons and repairs, which Tech Hexman will be covering in his discussion of the 'Mech Bay.



Lone Wolves

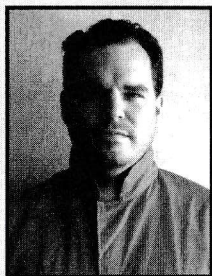

*"I used to work in a factory and only brought home 20,000 C-Bills a year. Now I'm making millions!"*

— Gary McPhail, Tri-M™ Graduate



### 'MECH OPS

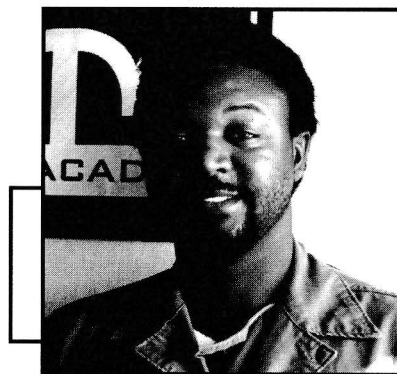

**Marriott Hexman**  
Chief Tech  
*"You break it, you buy it."*

Business skills are important, and so are piloting skills; but without techs, your 'Mechs would fall apart. And replacing a 'Mech is a very expensive process. Following is a description of the standard 'Mech Bay, where you can buy, sell, repair and outfit 'Mechs.

### 'MECH BAY

#### Arms Merchant

And people call *us* scum. Here you deal with your friendly neighborhood gunrunner, the lowlifes who keep us in business. As long as you've got the money, you can buy a huge variety of arms from him, and sell arms you salvage in the field. Keep in mind that, as technology increases, new weapons will become available.

#### 'Mech Factory

Here you can access a list of the 'Mechs currently available for purchase. Buying a new 'Mech is a huge expense, but a unit is only as good as its equipment. Keep in mind that if you see a 'Mech you want you'd better snap it up; the way the black market works around here, it may not show up again for a while.

#### Customize

Here you can add to your 'Mechs the weapons and components you have purchased. You can only customize with equipment in your inventory, and each customization costs a fixed amount.

#### Repair and Reload

'Mechs take a lot of damage and use a lot of ammo in the field, but here you can fix 'em up. If you don't have enough



Galtor Irregulars



money to repair the entire 'Mech, you can limit your repairs to individual items.

### Weapons Grouping

Here you can strategically organize your weapons in up to five groups. See **Weapons Grouping** section on the following page.

### WEAPONRY

Since weapons and ammunition are expensive, you *have* to learn to use your weapons systems as effectively and sparingly as possible. It doesn't do you any good if it costs you 500K C-Bills worth of ammo to complete a contract that only pays 300K. The major distinction you have to make when deciding on how to arm your 'Mech is between ammunition-based weapons and energy weapons. Ammunition-firing weapons, like missiles and autocannons, can run out of ammo — but they reload and fire quickly. Energy weapons, on the other hand, take time to recharge between shots and build up a lot of heat, but they never run out of ammo.

Before assigning weapons to your 'Mech, you should research your mission and prepare for the combat conditions you expect.

### Energy Weapons

**Lasers** — Light Amplification through Stimulated Emission of Radiation. Lasers damage their targets by concentrating energy in a small area.

**Particle Projection Cannons** — PPCs fire high-energy ion bolts that cause a lot of damage and really raise the target's heat level. They also take longer to recharge than lasers.

### Missiles

**Long-Range Missiles** — LRMs have basic guidance systems that lock them onto a target. "Splash damage" means that indirect hits cause almost as much damage as direct hits.

**Short-Range Missiles** — SRMs reach a high velocity for greater damage when fired at close range.

### Ballistic Weapons

**Autocannons** — Autocannons are rapid-firing auto-loading weapons that fire a stream of high speed, exploding, armor-piercing shells or magnetically propel a solid slug. Some ammo will fragment after being fired, improving the chance of making a hit.

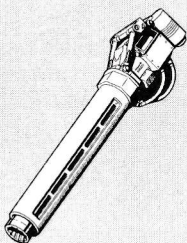
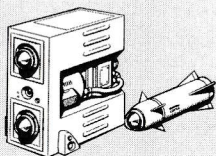
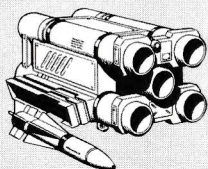
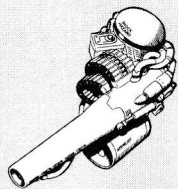

**Machine Guns** — Machine guns are rapid-fire ballistic weapons and one of the most effective weapons a 'Mech can carry. The volume of shots increases your chances of scoring a hit, but machine guns don't cause severe damage unless used at close range.

### Weapons Configurations

**Weapons Grouping** — Part of learning how to operate your 'Mech well is learning how to group your weapons. Your 'Mech's default Weapons Display shows all weapons in a single group by the 'Mech's left- and right-side designations. You can strategically organize your weapons in up to five groups designated by the colors GREEN, WHITE, YELLOW, LIGHT BLUE and DARK BLUE on the Weapons Display. This allows you to set up a weapons layout for the mission at hand (e.g., grouping missiles in the first group to allow time for reloading while other quick-loading groups can be fired). To do this, go to the **'MECH OPS** in the 'Mech Bay or, in combat, press **Shift plus 1, 2, 3, 4 or 5**.

**Chain-Fire vs. Group-Fire** — You can configure your weapons systems to two different firing modes: Chain-Fire or Group-Fire. Chain-Fire lets you automatically advance to your next available weapon, firing each weapon within that group one at a time. You can also use Chain-Fire mode with weapons systems that have been grouped; or you can designate Group-Fire mode, enabling you to fire multiple weapons within a specific group at the same time — called a "weapons dump."

Use the following keys:

- |                       |  |
|-----------------------|--|
| <b>Spacebar</b>       | Fires a weapon, or group of weapons if Group-Fire is engaged.      |
| <b>\ (backslash)</b>  | Toggles between Chain-Fire and Group Fire.                         |
| <b>Enter</b>          | Cycles from weapon to weapon.                                      |
| <b>' (apostrophe)</b> | Cycles from one weapons group to the next.                         |
| <b>;(semi-colon)</b>  | With Chain-Fire selected, fires all weapons in the selected group. |



12th Vegan Rangers



*"I've finally found a way to put my mean streak to good use, and make some money doing it."*

— **Danny Noonan**, Tri-M™ Cadet



Waco Rangers

**Alpha Strike** — Allows you to fire all weapons in a group and auto-switch to the next group by pressing **P**.

**Jettison Ammunition** — To jettison ammunition, select the weapon in the firing chain and activate the Jettison Ammunition system. This will prevent internal ammo explosions in damaged areas and allow you to dump ammo you're carrying for a damaged or lost weapon. To do this, select the desired weapon and press **K**.

Note: If one of your machine guns is selected to jettison its ammo, you will lose all ammo for all machine guns. If you have three SRM launchers, you will lose ammo for all three when you jettison the ammo for one.

### GUIDING A CAREER

My best advice to a virgin Merc is to use your head when you're outfitting a 'Mech. Decide what weapons and equipment you need based on where you're going and who you'll be fighting. Balance your weapons; on a hot planet, your 'Mech will overheat quickly if you're only using energy weapons, but ammo weapons can explode on you, and every round you fire costs you money. Be smart.



*"I've always dreamed of becoming a MechWarrior. And now I'm making that dream come true."*

— **Jessica Blue**, Tri-M™ Cadet



## COMBAT PROCEDURE

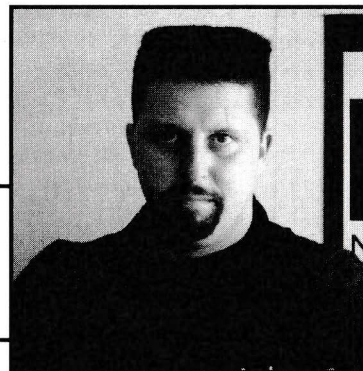

**Captain Mitchell Foxworth**  
Chief Pilot Instructor  
*"Kick ass or get killed."*

Once you've accepted a contract and bought and outfitted your 'Mechs, the real mercenary work begins. Your mission will start in the Starport, where you will board the DropShip that will start you on the road to destruction and profit.

### STARPORT

#### ComStar Terminal

ComStar plays a big part in a Merc's life: it holds all bonds for service, oversees contracts and provides the news service. At the terminal in the Starport, you can access from around the galaxy news that can help you decide which contracts to take. Keep an eye on the terminal; you don't want to sign on with someone who has just skipped out on a contract. And, if you pay attention to the news, you can stay out of trouble spots (or get *into* them if you wish).

#### Board DropShip

After you have selected your mission, a DropShip will transport you to the planet where the mission will take place. While your DropShip's in transit, you can access the on-board computer to prepare for battle.

**Finances** — Helps you keep track of your total funds and your monthly expenses.

**Inventory** — Shows your 'Mechs, weapons and ammunition.

**Duty Roster** — Here you assign the pilots and 'Mechs who will go into combat once you embark on a mission. Although you want to ensure that you include 'Mechs that can successfully complete the mission, remember that 'Mechs that don't go into battle can't be damaged. It may be better to avoid costly repairs on an expensive 'Mech if a lesser 'Mech can get the job done. These are the decisions that make the



Eridani Light Horse



difference between a rich Merc and a dead one. Here you can also assign aerospace pilots for aerial support, which you may need in some missions.

**Repair & Reload** — You can refit your 'Mechs while in transit as well as in the 'Mech Bay.

### Mission Computer

**Briefing** — Gives you a description of your mission and outlines your objectives. Clicking the **LAUNCH** button embarks you on your selected mission.

**Situation** — Offers background information on your mission and other Inner Sphere events.

**Abort Campaign** — Aborts your current campaign, at the loss of any additional payments.

## BASIC BATTLEMECH PILOTING

No matter what Kiowa and Hexman may have told you, 'Mech piloting is the *most* important aspect of being a Mercenary. If you can't fight, no one's going to hire you — it's that simple. The *best* pilots are those who can use their in-cockpit systems as extensions of their bodies — you have to *become* your 'Mech. And never forget your environment and mission objectives.

### Heat Management

Internal heat buildup is one of a 'Mech's worst in-combat dangers. A BattleMech builds up heat whenever it moves, fires its weapons or stands in an area of intense heat. A 'Mech's heat sinks are its only way to dissipate heat, and, if you overuse your weapons or stand in a high-temperature area, you may produce more heat than your 'Mech can tolerate.

If your 'Mech's internal heat reaches critical heat levels, ammunition or other systems may explode. Because of their huge purchase price, new 'Mechs are designed to shut down automatically when their heat thresholds exceed maximum critical levels. This forces the 'Mech to remain inactive until its heat falls below critical levels. You *can* manually override automatic shutdowns during emergency situations, but this maneuver should be used with great caution. If you do need to override shutdown, watch your heat tracking indicator closely. If it reaches full RED levels, you run the risk of a fatal explosion. Press the letter **O** to override automatic shutdown.

### Throttle

The throttle controls how much power you're sending to the 'Mech's engine, just like a twentieth-century gas pickup

truck. You can shift the throttle to incremental speeds, measuring from a complete stop at one (1), half throttle at five (5), and 100% power at zero (0) on the 'Mech throttle indicator in the cockpit control panel. Watch out — running at full throttle does have consequences. The more power you're sending to the engine, the more heat buildup and the higher risk of an ammo explosion.

You must always be aware of your surroundings and make throttle adjustments continually to accommodate your environment. You can severely damage a 'Mech's internals by colliding with another object at high speed.

You can also use the throttle to drive your 'Mech in reverse when you need to make a strategic retreat (hell, no need to die in one of these things). To do this, press **Backspace**. Refer to my discussion of the HUD for location of the rear-view camera so you can see where you're going when you're backing up.

Note: When you press **Backspace**, you will not immediately start going backwards; you must first slow down your forward movement, which may take some time.

### Steering

Basic 'Mech maneuvering depends on your ability to steer under combat conditions. Turning a 'Mech requires careful calculation of your present situation. Since the radius of a turn is directly related to the speed at which you are traveling, recommended procedure for executing a quick turn in a 'Mech is to throttle down before initiating the turn.

### Torso Twist

'Mechs are capable of torso movement of up to 90 degrees to the left or right of center, which allows you to travel in one direction but still engage an enemy on your flank. In order for this to be effective, torso twist timing and coordination are crucial. For you greenhorns, all I can say is *practice, practice, practice*. Your current torso twist is shown by a GREEN bar above the heading indicator in the HUD. Use the < and > keys to twist your torso.

You can also try a maneuver known as a Twist and Circle by torso twisting to one side and walking around the enemy in a large circle while firing at him/her. This allows you to be moving across your opponent's line of sight, making you a much more difficult target to hit.

### Pilot Eye Control

There are a variety of different views from the cockpit available to you. By pressing **Ctrl** plus an **Arrow Key**, you can

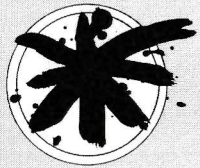

Moroushi's Independent  
Assault Battalion

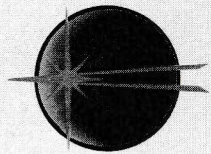

12th Striker  
Regiment



look left, right, up or down from inside the cockpit to see your surroundings without turning your 'Mech or torso. You can either glance in a particular direction or reorient yourself to face a different direction. Glancing around frequently will help you spot enemy threats not in your line of fire. *Be aware.* To glance left or right out of the cockpit, press **7** or **9** on the numeric keypad.

You can also zoom in or out from any of these interior cockpit views for a closer or wider view using the optical magnification system. To do this, press **Z** to zoom in, **Shift+Z** to zoom out and **Ctrl+Z** to reset zoom.

**External Tracking Camera (XTC)** — Gives you an over-the-shoulder tracking view of your 'Mech for a third-person combat perspective. To toggle XTC OFF and ON, press **C**.

**Satellite Uplink** — Gives you a bird's-eye view of the area from a geosynchronous observation point one kilometer overhead. This wire-frame representation of the satellite view is beamed into your neurohelmet. You can increase the satellite uplink scaling factor to see a more detailed representation of an area, or decrease the scaling factor to cover a larger radius of the overhead view. **F3** toggles the satellite uplink ON and OFF. To zoom in on the radar/satellite uplink press **X**, and to zoom out press **Shift+X**.

Use the satellite uplink (**F3**) to dodge enemy fire when they are hot on your trail. Also, when you only need to get back to the DropShip alive, switching to **F3** allows you to see the missile trail of enemies from behind while blazing full-speed ahead towards your destination. Using the satellite uplink is even more useful if you have jump jets because you can then dodge even faster.

**Thermal Optics** — During night battles or when visibility is low, you can rely on this infrared system's sensors to project enhanced images of the otherwise indistinguishable environment. To activate, press **L**.

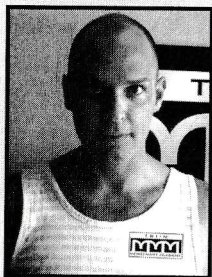

*"Tom Cowhey, loser. That's what people used to say. Now they say Tom Cowhey, Mercenary. And I owe it all to Howard!"* — Tom Cowhey, Tri-M™ Graduate

## HEADS-UP DISPLAY (HUD) SYSTEM

The connection between a 'Mech and its pilot is the neural-impulse helmet. Your neurohelmet covers your head and attaches to the shoulders of your cooling vest (these 'Mechs really get *hot*). Electrodes inside the helmet channel sensory information from the BattleMech directly to your brain. Vital information is projected onto your retina so you don't have

to look down while some 100-ton Atlas is bearing down on you. This is your *lifeline*. And if you get hit, these systems will go down. So don't get hit.

## Radar System

The radar display shows all enemy threats and friendly 'Mechs within a one-kilometer (default) radius of your BattleMech. All enemy objects are RED blips, all friendly craft are GREEN, any neutral data BLUE and NAV points YELLOW. The "V" shows the resulting field of view based on the angle of the 'Mech's torso.

The radar screen's zoom function increases the level of detail in the radar display while decreasing the overall range from 2.0 kilometers to 250 meters. You can also toggle between the standard size radar display to a full-screen radar mode that shows up as an overlay centered around your 'Mech's crosshairs. The radar system also shows your currently targeted enemy by bracketing or highlighting the blip. The radar display also shows your currently targeted NAV point. More about that when I turn to "NAV Points" under "Navigation" in this section.

Press **F2** to maximize radar to full screen, and press **F2** again to minimize it and place it in the upper left corner. You can also zoom in on the radar screen by pressing **X**, and zoom out by pressing **Shift+X**.

## Heading Indicator

This directional indicator shows you your 'Mech's heading in degrees, with "N" indicating 00 or zero. RED arrows will appear on the indicator to show the direction to the targeted object, and a GREEN bar above this indicator gives the degree of your torso twist.

## Weapons Display

In the upper right-hand corner of the HUD, this display shows all the weapons you're carrying. The weapon you've currently selected will be outlined, and any weapon that's been destroyed appears in BLACK. The default displays all weapons in a single group arranged by the 'Mech's left- and right-side assignments. The Weapons Display can also show up to five distinct weapons groups designated by the colors GREEN, WHITE, YELLOW, LIGHT BLUE and DARK BLUE. Check out Tech Hexman's "Weaponry" section for procedures on "Grouping Weapons."

**Note:** After firing a weapon, the name of the fired weapon will turn RED while it is reloading. When it returns to its regular color, it is ready to fire again.

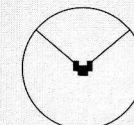

RADAR DISPLAY

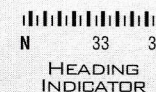

HEADING INDICATOR



Alt: 0.00 m

ALTIMETER



THROTTLE INDICATOR



TARGETING RETICLE



TARGETING BRACKET



TARGETING MARKERS



TARGETING CAMERA

### Altimeter

The altimeter measures your 'Mech's current elevation from the horizon in meters. The altimeter is especially useful when considering the atmospheric effects of navigating over mountainous areas or while using jump jets.

### Throttle Indicator

This HUD indicator measures the current throttle power used by your BattleMech — with GREEN indicating forward throttle power and BLUE indicating reverse throttle. To the left of the throttle indicator a small read-out shows your 'Mech's current speed in kilometers per hour, indicating negative kilometers per hour for reverse throttle movement. Press the number 1 (stop) or the number 0 (fastest) to control the throttle.

### Targeting Reticle

The targeting reticle indicates the object on which you're focusing your weapons. The reticle is GREEN when your weapon is armed and ready to fire, and YELLOW when your weapons are recharging or reloading. When the targeting reticle is RED, you've got the object in range and on-target; or, in the case of homing weapons, your targeting computer has made a lock.

### Targeting Brackets and Markers

When you target an object, targeting brackets will appear around it. The brackets will appear in GREEN to indicate a friendly object; RED to mark an enemy object; and BLUE for any neutral targeted object, like non-enemy structures.

A RED targeting marker appears on the heading indicator to show the relative direction of the current target.

### Targeting Camera

The targeting camera screen identifies the targeted object, showing its current actions and its orientation to the pilot's 'Mech. It also displays the targeted object's current damage. The enemy 'Mech's damage is indicated in three colors: GREEN = None or Superficial; YELLOW = Moderate; RED = Critical; BLACK = Maximum. Refer to "Target View" under "Targeting" in this section.

### Targeting Information

When you target an object or NAV point, your 'Mech's targeting system identifies the targeted object's name and its current range in meters. This targeting information appears at the bottom left side of the HUD (below the targeting



OFF-SCREEN TARGETING INDICATOR

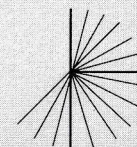

HEAT TRACKING INDICATOR



Jets  
JUMP THRUST INDICATOR



H T A L  
DISPLAY

camera display screen if you have it enabled). You can also access further targeting information about some objects by activating the Inspection command. Press the letter I to identify.

### Off-Screen Targeting Indicator

If a targeted object advances past your visual range, an off-screen targeting indicator will alert you to the relative heading of the target. This indicator appears in the form of a RED arrow along the perimeter of your HUD to indicate a targeted object. This off-screen target information also appears in a scaled-down display on the radar screen.

### Heat Tracking Indicator

The heat indicator measures your 'Mech's heat buildup and dissipation. It tracks heat in three measures: GREEN = Nominal Heat; YELLOW = Marginal Heat; and RED = Critical Heat. The DeltaHeat Indicator constantly surveys your BattleMech's current rate of change in heat buildup. Press the letter O to override shutdown.

### Jump Thrust Indicator (JTI)

The JTI will be displayed on the HUD of your 'Mech *only* if it is equipped with jump jets. It measures the remaining amount of charge in your 'Mech's jump jets. Press J to activate jump jets.

### Multi-Function Display (MFD)

This HUD is automatically initiated at launch. You can choose between optional camera views by pressing F1 to cycle through all available modes.

**HTAL (Head Torso Arm Leg) Damage Report** — This detailed display shows section-specific damage information of your 'Mech's structure and remaining armor for that area (marked in GREEN). A bar measures damage to each corresponding section: head, torso, arms and legs — with torso being broken up into left, center and right, each with a separate front and back section.

**Rear View** — The rear-view camera can be activated to display a behind-the-'Mech exterior view to get a handle on what's going on behind.

**Front View** — Good for use with external (XTC). Helps you steer and target while viewing from the outside.

**Down View** — The down-view camera captures a lower view from directly beneath your 'Mech, which is useful during jump jetting, especially while attempting DFA. Refer to



"Jumping" under "Advanced Piloting" in this section for DFA procedures.

**Satellite View** — Lets you view the satellite uplink from the main cockpit.

**Weapon View** — The weapon-view camera can be activated upon firing off a weapon to track its path until it reaches its target. By pressing **F10**, a pilot can also activate a full-screen weapon view once a salvo of missiles has been launched to track its progress.

You might want to use your long-range missiles as scouts. To do this, fire off a round of missiles, then press **F10** to activate the missile cam. This allows you to ride along with the missiles and see what's up ahead of you.

### Objectives/Briefing Summary

If you get flustered in combat and need to be reminded of your mission, you can access a short-form report of the target bonus bounty objectives. It'll also show you which objectives you've completed and the status of current ones. Press **F12** to activate briefing summary.

Another source of in-combat information is the com-link, which connects you with other 'Mechs and with your DropShip. At any time, you may receive new or alternate instructions, so be prepared and listening!



*"The Free Rasalhague navy rejected me three times. Low IQ, they said. Now I'm at Tri-M™, learning how to pilot a 'Mech for just 40,000 C-Bills a year! Who needs a high IQ? And what does it stand for anyway?"*  
— Greg Keenan, Tri-M™ Cadet

### NAVIGATION

Often a mission will require you to follow a predetermined navigational (NAV) sequence. Each NAV sequence is mapped out before the mission, giving you directional guidance to targets, structures or locations.

#### NAV Points

NAV points are the locations that make up your navigational sequence. You can enable your 'Mech's navigational targeting computers to receive a signal of the sequence on your neurohelmet display. You can then cycle through all of the NAV points in sequence to determine their relative locations.

Once a NAV point has been targeted, you can access targeting information on the specific NAV point designated by the letters of the Greek alphabet. If the targeted NAV sequence is

out of radar range, the off-screen targeting indicators will point toward the targeted NAV point. Once a NAV point has been reached, its color changes in all display screens to indicate such. Press **N** to cycle through the NAV points.

### Autopilot

'Mechs are equipped with systems that automatically direct you to the next unreached NAV point. Your autopilot system comes in handy when other systems demand your attention. Press **A** to toggle autopilot ON and OFF

Note: Autopilot is automatically disengaged once you re-establish control of your 'Mech.

### TARGETING

Along with the various special targeting systems developed for streak missiles, 'Mechs are equipped with targeting systems that can give you information about targeted objects and enhance the performance of direct-fire weapons such as lasers, PPCs, Gauss rifles and autocannons.

#### Targeting Info and Ranges

One of the most effective functions of a 'Mech's targeting system is its ability to determine the range of a targeted object. Upon activating a 'Mech's targeting system on a particular object, a bracket display appears around the targeted object. The targeted object is then identified by name, and its range is given in meters. This targeting data can be accessed on the targeting information read-out for you to decipher objects underneath the reticle or the nearest enemy target, or to cycle through data on all available targets. When a target is in range of a selected weapon, your reticle turns RED.

Press **Q** to target objects underneath the reticle, press **T** to cycle through all targets, press **F** to target friendlies and press **E** to target the nearest enemy.

Deciphering ranges is an important aspect of weapons management. It allows a seasoned MechWarrior to fire short-, medium- and long-range weapons strategically, aiding weapons management. When I'm through with you, you *will* have this skill.

#### Target View

After enabling your 'Mech's targeting system, you can access a visual representation of the targeted object via your targeting camera. The targeting camera shows the object's current bearing and its present actions in relation to your 'Mech. However, upon suffering a critical hit, a BattleMech

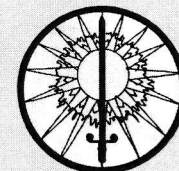

House Davion



Wolf's Dragoons



could suffer damage to any of its camera system sensors, rendering them inoperable. Refer back to my discussion of the HUD.

### Inspection

Many recon missions depend on a MechWarrior's ability to inspect likely targets such as enemy structures or foreign objects. To inspect a target, you must first position your 'Mech within range of the object, activate the targeting system and enable the inspection scanner. The Targeting Information System will then receive all information detailing the contents of a prospective target. If you attempt to inspect an object that is out of range or whose contents are not relevant, the Targeting Information System will display the cause of the denied inspection. Enemy 'Mechs will become aware of you when scanned. Press the letter I to activate the scanner.

### DAMAGE AND CRITICAL HITS

A 'Mech can sustain damage to eight separate locations: head, left torso, center torso, right torso, left arm, right arm, left leg and right leg. Each of these locations is equipped with a layer of armor that covers the internal structure and protects the contents housed inside. The torso armor is divided into front and back sections. Damage to the armor of each piece is tracked in the HUD by both the Damage Display and the HTAL.

Your 'Mech can be damaged in several ways: weapon impact, proximity to an explosion (splash damage), internal ammo explosion (cookoff) and collision with another object. Once the armor in a certain section has been depleted, your 'Mech can take damage to that section's internal structure. For each hit to the internal structure of a part, there is the risk of a critical hit.

A critical hit indicates that the equipment located within the affected section has suffered damage. Different types of equipment will react differently when delivered a critical hit:

- ✓ Weapons are rendered inoperable.
- ✓ Ammunition explodes (causing an internal ammo explosion).
- ✓ Hips, feet and legs become damaged and affect movement rates.
- ✓ Jump jet exhaust ports jam, thus taking away your ability to use your jump jets.
- ✓ Heat sinks are lost and your heat dissipation decreases.

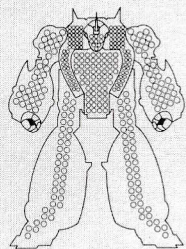

- ✓ Engines are damaged, decreasing the 'Mech's speed.
- ✓ Gyros break, preventing jump jetting and affecting maneuvering.
- ✓ Sensors become unreliable, affecting in-cockpit systems.
- ✓ Life support systems fail, which can be fatal to the pilot in hostile environments.
- ✓ A critical hit to the cockpit kills the pilot instantly.

Some critical hits cause a 'Mech to lose its damaged section; this is known as "chunking." The components in a chunked section are (obviously) rendered inoperable. Internal ammo explosions can be triggered by a critical hit or by excessive heat levels if you override automatic thermal shutdown. In the case of an ammo explosion, the damage is applied to the section in which it was stored.



*"People say I never finish anything I start. I've enrolled in a lot of schools, but Tri-M™ is the first I ever finished. Now I've signed up with the Wolf's Dragoons, and I've got 17 kills this year alone!"*

— Kevin Faulkner, Tri-M™ Graduate

### ADVANCED PILOTING

My more advanced students will also learn a few of the tricks that have kept me in the merc business this long, the real tricks of the trade. I would caution any of you cub scouts from trying these until *after* considerable instruction in 'Mech piloting.

### Weapons Grouping

Put weapons with long recharge times (like missiles) in their own weapons group. Then you can move to another group of faster firing weapons while they're recharging. This way you don't have to skip over the missiles while they are inactive, and you won't fire them accidentally before they are locked if they happen to recharge while you are firing.

### Jumping

Jump jet technology was originally developed to give 'Mechs jump capability for access to higher ground and maneuvering, but certain MechWarriors have refined jump jet maneuvers for use in combat. Since a 'Mech's mass significantly hinders its speed, jump jetting capability is used consistently by heavier 'Mechs for linear acceleration, letting them gain great distance in short periods of time. Another common practice is to use jump jet capability to execute rapid turning

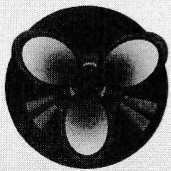

Smithsonian's Chinese Bandits

maneuvers that a pilot may not otherwise be able to perform; this is widely employed by slow 'Mechs.

The most famous jump maneuver, and my personal favorite, is DFA, or "Death From Above." Talented MechWarriors like myself are able to coordinate their jump jets and steering to land precisely on an enemy 'Mech's head. Since leg armor is stronger than average head armor, DFA can destroy an enemy 'Mech on impact. Not that you cadets will be doing this any time soon, but, when attempting DFA, you should access the down-view camera on the MFD to improve your accuracy.

Often you will see incoming fire approaching. If you are quick enough, use your jump jets to side step out of the line of fire. This works particularly well against PPCs.

### Manual Shutdown

If your 'Mech reaches critical heat levels during battle, you can initiate manual shutdown to dissipate heat rapidly and cool your 'Mech down to a safe temperature. Some MechWarriors also use manual shutdown to deceive the enemy, since 'Mechs that have initialized the shutdown sequence cannot be detected on enemy radar. This advanced maneuver must be strategically timed to be effective. The same function starts up your 'Mech after manual shutdown. Press **S** to shutdown, and press the letter **O** to override shutdown.

### Pilot Auto-Ejection

'Mechs are equipped with sensors that detect imminent internal explosions. The cockpit ejection system is designed to eject you when your 'Mech's damage has reached critical levels. Once activated, this system triggers the cockpit canopy to be blown away by explosive bolts and you are rocketed away from your disabled 'Mech. You can choose to override automatic pilot ejection, a practice used by pilots who'd rather die in their 'Mechs than leave 'Mech technology for salvage or be ejected onto a planet with a hostile atmosphere. Didn't say it was smart, just said it was possible. Press **Ctrl+E** to toggle Auto-Eject ON and OFF, and press **Ctrl+Alt+E** to eject.

### Thermal Optics

Enhanced images are transmitted into your neurohelmet as infrared images, giving you a virtual representation of the outside world. This system has proven an invaluable environmental aid due to its effectiveness in cutting through dense atmospheric conditions and enabling visibility. Press **L** to activate thermal optics.



### Commanding a Lance

In battles calling for lance coordination, a MechWarrior in the position of lance commander (unit 1) can command his or her lancemates. To command a lancemate, press **Alt** plus the corresponding number.

**Attack Target** — A lance commander can assign a particular lancemate to attack a predetermined target. This object must first be targeted by the commander before the target information can be transmitted to the lancemate. Press **Alt+A** to attack a target.

**Defend Target** — A pilot can also assign a lancemate to defend a target. The commanding lancemate must first acquire a lock on the object before a lancemate can receive the command. Press **Alt+D** to defend a target.

**Join Formation** — A lancemate can be called to join a formation s/he's not currently a part of once the battle has commenced. Press **Alt+J** to join a formation.

**Disengage and Reform** — Once a command has been made or a lancemate has been otherwise committed, a lance commander can also choose to withdraw the order and call the lancemate back to rejoin the formation, regardless of the lancemate's current combat status. To do this, press **Alt+R**.

**Engage at Will** — This command orders lancemates to search their radar systems actively in order to engage targets as they become readily available. Press **Alt+W** to engage at will.

**Shutdown** — A lance commander can order a lancemate to shut down at any point. This practice is effective in camouflaging 'Mechs on an enemy's radar detection system. To shutdown, press **Alt+S**.

**Flee** — Allows the lance commander to call off a mission and retreat. Better to break a contract than to be annihilated. To flee, press **Alt+F**.

A good way to use an unskilled lancemate is to make him or her a decoy to draw enemy fire. Fix up a cheap, heavily armored 'Mech with a few low-cost energy weapons and let her or him attract the enemy's attention while you go about completing the mission. S/he may not love you for it, but we aren't in this business to make buddies.



*"Outreach is a great place to live. I'm actually meeting the Mercenaries I used to read about."*  
— Christine Daley, Tri-M™ Cadet



Hansson's  
Roughriders

## Commanding Aerospace Fighter Support

If you have hired aerospace fighters to provide air support, you can call for an airstrike at any time during a mission.

**Alt+X** brings on a strike against a targeted enemy, and **Alt+C** calls it off to bring the aerospace fighters back into a holding formation

## ENVIRONMENTAL CONDITIONS

Your 'Mech's capabilities are significantly affected by the environmental conditions of each mission. You should always take into consideration the terrain and atmospheric conditions of the planet where an engagement is to take place.

### Temperature

A 'Mech's likelihood of overheating is primarily determined by its size, weapons systems and over-activity, but ambient temperatures can also affect your 'Mech's heat dissipation rate. If a planet's temperature is extremely hot or cold, your 'Mech's heat buildup will increase or decrease accordingly.

### Atmosphere/Gravity

The varying gravitational and atmospheric conditions of planets can supplement or limit certain 'Mech capabilities. You must also remember that hostile environments do not allow auto-ejection.

### Terrain

Different types of terrain can have a significant effect on a BattleMech's efficiency. The ease in navigational ability can be determined by the frictional coefficient on any sloped terrain. Man-walker 'Mechs are more effective on rugged terrain than reverse-joint chicken-walkers, since chicken-walkers are low to the ground and have less leg flexibility for climbing mountains or going over steep inclines.

### Time of Day

The time of day when a mission occurs can affect your pilot- ing capability. Since environmental changes occur at different times during the day, you must consider such effects before deploying a specific 'Mech configuration and using in-cockpit systems such as thermal optics.



Wilson's Hussars

## GUIDING A CAREER

Advice on being a Merc? I'd say one of the most important aspects of combat, and one that too many people don't consider, is keeping an eye and ear on how the battle is progressing. In combat, listen closely to your com-link. Friendly troops and sometimes even the enemy will give you vital information. If you're losing a battle, find a way out. You've got to run away when you can't survive a mission, or it'll cost you more than you're being paid. And remember that sometimes a losing battle can turn into a winning one: a generous enemy may let you switch sides, and we are, after all, Mercenaries.

I'm not gonna lie to you. There's a lot to learn, and it's a lot harder to remember when you've got a Draconis *Orion* emptying its autocannons into your chest. This is not a course in 'Mech piloting — you'd have to be crazy to go into battle with just what I've told you here — just an overview of what Tri-M™ has to offer.



"Murderer? Well, that's a harsh word. I prefer to think of myself as a 'mortality technician.'"

— Pete DiBiasio, Tri-M™ Graduate



## Appendix A — BATTLETECH HISTORY

**July 8, 2784:** General Alexandr Kerensky gives his fateful order, "Exodus," and 200 transports, filled with scientists, soldiers and the best minds of the Inner Sphere, vanish from known space. For the next 300 years, the Successor Lords use their regiments of BattleMechs, giant humanoid war-machines once used for heavy labor and construction, to destroy what remains of the Star League, each Successor Lord trying to place himself on the throne. Humanity falls into darkness.

**May 10, 3044, the present:** Three hundred years of war have nearly destroyed humanity's ability to build war machines. Only a few factories remain active, churning out BattleMechs for the four Successor States that still battle for the almost forgotten throne of the Star League. Most BattleMechs are salvaged from battlefields, the victors scavenging what they can from the fallen.

Mercenaries now sell their strength to the Successor States, all bidding for the best contracts with the most powerful warlords. On the periphery, outside of the Successor States, pirates rule petty "Bandit Kingdoms." From the fringes of human space, the Bandit Kings raid weakened Successor Lords for precious water and spare parts.

Despite centuries of war, the battle continues.

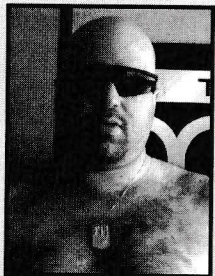

*"It's not just a school — it's more like a family. I'm not just learning how to kill; I'm also making friendships that will last a lifetime."*

— Andy Hopkins Tri-M™ Cadet



## Appendix B — CONTROL SYSTEMS

### MOUSE

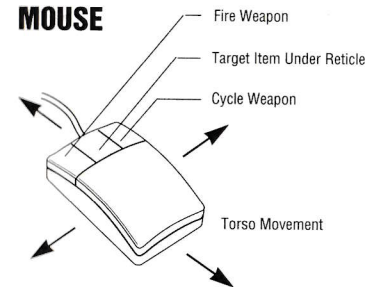

### MICROSOFT SIDEWINDER

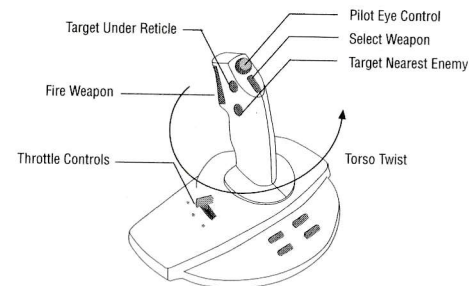

### CH JOYSTICK

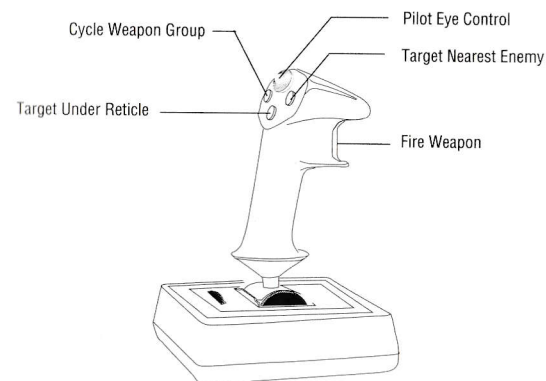

Brion's Legion



McGee's Cutthroats

## PHOENIX SYSTEM

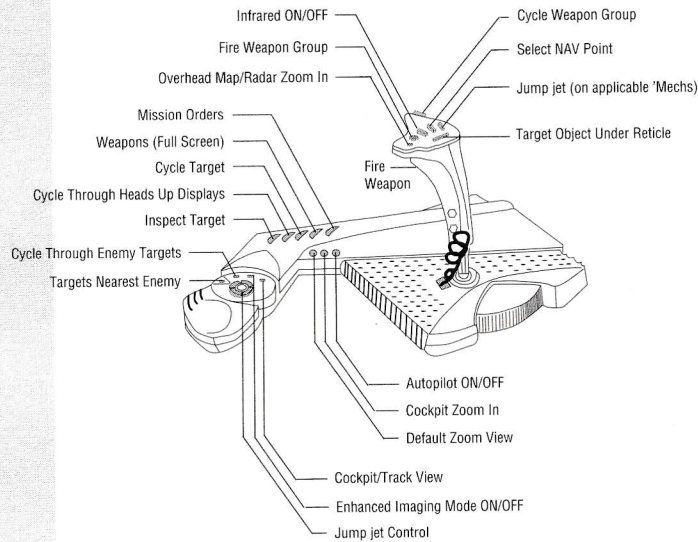

**NOTE:** Pilots opting to control their BattleMechs with the Gravis Phoenix can access a pre-generated map in the form of custom controller configuration files in the CFGS subdirectory, or create their own.

## THRUSTMASTER JOYSTICK

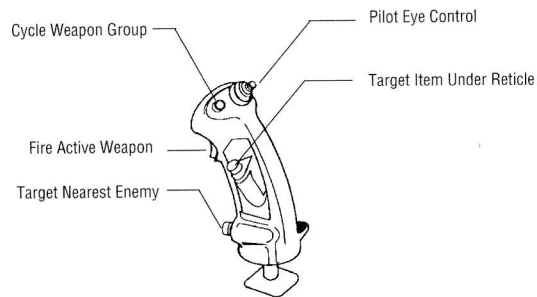

## THRUSTMASTER WCS

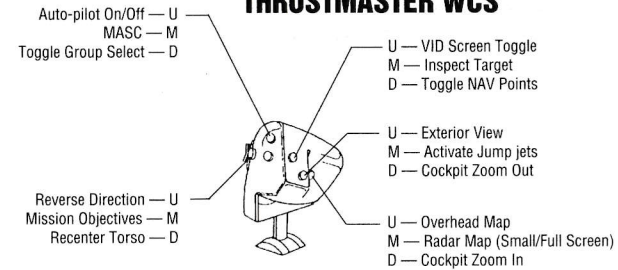

**NOTE:** Pilots opting to control their BattleMechs with the Thrustmaster WCS can access a pre-generated map in the form of custom controller configuration files in the CFGS subdirectory, or create their own.

U = Rocker in up position  
M = Rocker in middle position  
D = Rocker in down position

## VIRTUAL I/O HELMET

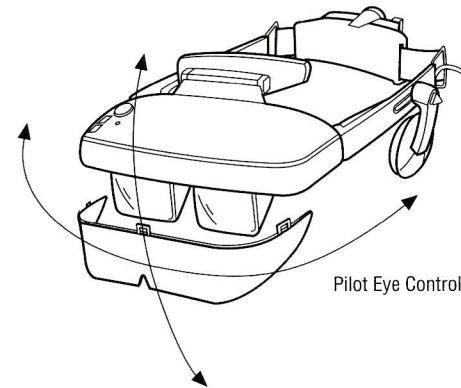

## RUDDER PEDALS

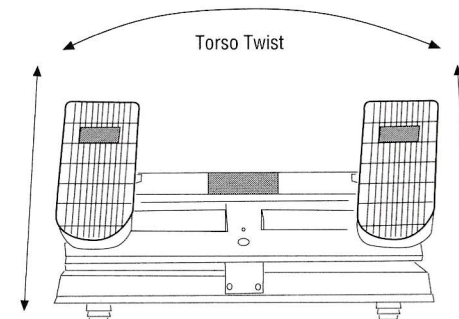

Wolfnet



## Appendix C — INNER SPHERE WEAPONS

WEAPON	HEAT	DAMAGE	RANGE	TONS	CRITS	AMMO/ TON
ER Large Laser	12	8	570	5	2	Nil
ER PPC	15	10	690	7	3	Nil
Flamer	3	2	90	1	1	Nil
Large Laser	8	8	450	5	2	Nil
Medium Laser	3	5	270	1	1	Nil
Small Laser	1	3	90	0.5	1	Nil
PPC	10	10	570	7	3	Nil
Pulse Laser (Large)	10	9	300	7	2	Nil
Pulse Laser (Medium)	4	6	180	2	1	Nil
Pulse Laser (Small)	2	3	90	1	1	Nil
Anti-Missile System	1	Nil	Nil	0.5	1	12
Autocannon/2	1	2	720	6	1	45
Autocannon/5	1	5	570	8	4	20
Autocannon/10	3	10	450	12	7	10
Autocannon/20	7	20	360	14	10	5
Gauss Rifle	1	15	660	15	7	8
LB 10-X AC	2	10	540	11	6	10
Machine Gun	0	2	90	0.5	1	200
Ultra AC/5	1	5	600	9	5	20
LRM5	2	1/per	630	2	1	24
LRM10	4	1/per	630	5	2	12
LRM15	5	1/per	630	7	3	8
LRM20	6	1/per	630	10	5	6
Narc Missile Beacon	0	None	270	3	2	6
SRM 2	2	2/per	270	1	1	50
SRM 4	3	2/per	270	2	1	25
SRM 6	4	2/per	270	3	2	15
Streak SRM-2	2	2/per	270	1.5	1	50
Arrow IV System	10	20	2 km	15	15	5
CASE	0	0	Nil	0.5	1	Nil
Heat Sink	-1	Nil	Nil	1	1	Nil
Double Heat Sink	-2	Nil	Nil	1	1	Nil



## WEAPONS DESCRIPTIONS

### EXTENDED RANGE LASERS

The extended-range laser is an upgraded version of the basic laser with improvements that are obvious in its superior beam focusing and targeting equipment. The small extended-range laser is the lightest of all. It causes less damage than the large version and generates less heat. The medium version is heavier than the small version, but with more of the same advantages and drawbacks of the larger model. The large version of the ER laser has a significant increase in range and a damage potential that is slightly higher than the basic model, at a cost of substantially more heat than the other versions.

### EXTENDED RANGE PPC

The Particle Projection Cannon fires high energy ion bolts which cause damage through both the impact and high temperature. Extended-range PPC is a significantly improved version of the particle projection cannon. This PPC is smaller, lighter and more powerful than the basic version with its longer range and harder punch. Heat buildup is also much higher and could be a critical disadvantage of employing this weapon.

### PULSE LASERS

The pulse laser uses a rapid-cycling, high-energy pulse to generate multiple laser beams, creating an effect comparable to machine-gun fire. This characteristic improves each laser attack's hit probability with more damage per hit at the cost of increased heat and a somewhat shorter effective range. They too are available in small, medium, and large versions.

### GAUSS RIFLE

The Gauss rifle uses a series of magnets to propel a projectile through its barrel and towards a target. While requiring a great deal of power to operate, it generates very little heat and can achieve a muzzle velocity twice that of any conventional weapon. Gauss rifle ammunition consists of nickel-ferrous metal slugs. If Gauss ammunition takes a critical hit, there is no explosion, but the hit destroys the ammo-feed mechanism rendering the rest of the ammunition in that location useless. A critical hit on the Gauss rifle itself destroys the capacitors that power this weapon. Such destruction causes a catastrophic discharge of the capacitor's stored energy with results similar to an ammunition



explosion. If a Gauss rifle takes a critical hit, it causes an ammunition explosion in the location containing the rifle.

### **LB-X AUTOCANNON**

The LB-X autocannon makes use of light, heat-dissipating alloys to reduce weight and heat buildup. The reduced space and weight requirement of the LB-X autocannon allows this weapon to mount more sophisticated fire-control systems.

In addition to these advantages, the LB-X autocannon can use special cluster munitions that act much like an anti-BattleMech shotgun in combat. When fired, the ammunition fragments into several smaller submunitions. This improves the chances of scoring a hit and striking a critical location, but reduces overall damage by spreading hits all over the target area rather than concentrating on one location. The 5X autocannon causes five times as much damage as the common model, and the 20X causes 20 times more damage than the common model.

### **MACHINE GUN**

The machine gun is a rapid-fire weapon. It is one of the lightest yet powerful weapons a BattleMech can carry. The sheer volume of machine gun rounds which can be shot at close range increases the probability of scoring a hit, but does not cause severe damage to its target.

### **ULTRA AUTOCANNON**

The ultra autocannon features a short, smooth-bore barrel, a modified breech mechanism, a rapid-feed reloader and specially designed ammunition. The AC/5 version causes five times more damage than the common model. The ultra AC/10 causes ten times the damage and more heat build-up, while the largest version causes 20 times the damage.

### **SHORT-RANGE MISSILES**

Short-range missiles are specially designed to fire at close range. Although the SRM-2 missile fires only two missiles at once, it can cause more damage than a missile in the long range missile group. The SRM-4 fires four missiles at once and the SRM-6 version delivers six missiles in one powerful shot.

### **STREAK SHORT-RANGE MISSILES**

These short-range missile launchers are linked to a computerized fire-control system which handles target acquisition. Once the computer obtains a target lock, the streak missile

will automatically home in on its target. The sure-hit SRM-2 fires two missiles at once while the SRM-4 blasts four missiles worth of firepower. The SRM-6 tops the streak missile family with a six-pack blast of guided bliss.

### **LONG-RANGE MISSILES**

The long-range missile is a specialized weapon designed to make contact with its target at long range through the use of its guidance system. The LRM-5 sends off a five-pack of missiles at once. The LRM-10 fires off ten missiles with one blast. The LRM-15 fires off a 15-pack of missiles and the LRM-20 leads this family of missiles with a 20-pack of pure missile power. Its indirect hits have been known to be as effective as its direct hits due to area-effect explosions known as "splash damage." LRMs won't "lock" at distances under 75M.





## Appendix D — BATTLEMECH COMPONENTS

The internal structure of a BattleMech is composed of eight sections: Head, Center Torso, Left and Right Torso, Left and Right Arms, and Left and Right Legs. Each of these sections serves as a designated area for carrying weapons, ammunition or additional equipment in a BattleMech. The following are the systems that comprise a BattleMech:

### ENGINES

BattleMechs can be equipped with a wide variety of engines to determine maximum land speed. There are two types of engines: standard or XL engines. The XL engines are retrofit standard engines with new and lighter shielding materials, greatly reducing overall engine weight at the cost of compactness. Although normal engine weight is halved, additional engine critical space must be allocated to both the Right and Left Torsos.

### COCKPIT/GYROSCOPE

Every BattleMech includes a cockpit containing the MechWarrior's control station, life-support system and electronic sensors. Damage to a 'Mech's control components impacts its ability to move and jump. In addition to a cockpit, every BattleMech is equipped with a powerful gyroscope to keep it upright and able to move.

### INTERNAL STRUCTURE

Internal structure is the backbone of the 'Mech. A BattleMech's internal structure can be designed in using one of two advanced technologies: standard or Endo Steel. Made with zero-G manufacturing techniques that mix high-density steel with lower-density titanium and aluminum, Endo Steel is twice as strong per unit of weight as standard materials. However, strength is traded at an increase in overall bulk requiring more critical space in a 'Mech's internal structure.

### HEAT SINKS

Heat sinks supply a BattleMech with the ability to dissipate heat internally. Double heat sinks can cool a 'Mech much more efficiently with a heat-dissipation rate that is twice as fast as that of standard heat sinks. Although double sinks weigh the same as standard heat sinks, the double versions are considerably bulkier and take up extra space aboard a 'Mech. At one ton and two critical slots each, Torso-mounted double sinks tend to limit space for weapons.

### JUMP JETS

Most 'Mechs can be equipped with jump jets located in pods in the Leg and Torso areas to allow jump movement. Jump jets may only be mounted if there are sufficient critical slots in these areas. To gain desired jump capacity, a MechWarrior must evaluate the environmental conditions of the mission as well as the overall mass of the 'Mech being customized before determining the number of jump jets to be added.

### ARMOR

A BattleMech's armor provides the protective covering for its internal structure and critical components. There are two types of armor a pilot can choose to assign to a BattleMech: normal or Ferro-Fibrous armor. Ferro-Fibrous armor is an improved version of the ordinary BattleMech armor in that it greatly increases a 'Mech's tensile strength. Although this advanced armor gives a 'Mech a greater armor factor for the same weight, it is bulkier than its equivalent weight of standard armor plating and requires more critical space in a 'Mech's internal structure.

### WEAPONS SYSTEMS

Pilots can equip their 'Mechs with any mix of weapons their assigned base chassis will support. MechWarriors must weigh the advantages of using different energy, missile or ballistic weapons systems against the weight and space considerations of all possible combinations. Some weapons systems are more powerful at the expense of greater heat buildup, while other weapons cause less damage but have greater distance advantages.

### AMMUNITION

All weapons other than energy weapons (e.g., lasers) require a pre-allocated supply of ammunition that can be determined by each pilot. Ammo must also be allocated to critical slots within a 'Mech's internal structure.

### EQUIPMENT

Some BattleMechs are equipped with CASE (Cellular Ammunition Storage Equipment), a damage-control technology that mitigates the effects of internal ammunition explosions. When ammo explodes in a location with CASE, the force of the explosion is directed away from the 'Mech's vital components, such as the cockpit or the engine. BattleMechs without CASE can be destroyed by a single internal ammunition explosion.





## CRITICALS

All components housed within a BattleMech must be assigned to critical slots within a 'Mech's internal structure. The number of available critical slots in each section of a 'Mech's base chassis limits the mix of weapons and equipment with which any particular 'Mech can be configured. The construction of a BattleMech cannot be completed until each item has been assigned to the requisite number of critical slots.

## Appendix E — NAVIGATING THROUGH MERCNET

To start *MercNet*, change to the hard drive and directory where you installed *MechWarrior 2: Mercenaries* for MS-DOS. At the DOS prompt type **MERCS**, press **Enter** and select **MercNet**. (Note, you can skip the opening movie by pressing the **Spacebar**.) This will bring you to the Transport Selection Screen.

To go directly to *MercNet*, at the DOS prompt type **MERCNET** and press **Enter**. If you're running Window 95, you can start *MercNet* by opening the folder in which you installed it, and double-clicking on the **MercNet** icon.

### TRANSPORT SELECTION SCREEN

**ENTER CALLSIGN** — Type in your name. Note: This field must be filled, or you will not be able to enter the game.

**SELECT CONNECTION TYPE** — Choose **IPX** if you wish to play via IPX network; **Modem** if you wish to play via modem; or **Null Modem** if you wish to play via direct cable hookup between two computers. Click on your selection, then click the **SELECT** button or press **Enter**.

Note: If you choose **IPX**, you will be taken directly to the Game Selection Screen.

**QUIT** — Click this button to exit *MercNet* and retreat to the safety of your operating system.

**QUICK HELP** — As you move your cursor around, a brief description of each section of the screen will appear here.

### TELECOM COMMUNICATION SCREEN

If you choose **Modem** in the Transport Selection Screen, the Telecom Communication Screen appears. Note: Only two warriors can play via modem.

**MERCENARIES** — The callsigns of the players appear here.

**PHONE NUMBER** — Listed here is the phone number of your fellow MercNet player.

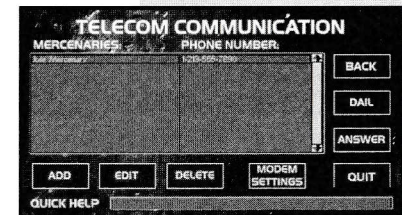



**ADD** — If you click this button, the Warrior Entry Screen will appear, allowing you to add new warriors and their phone numbers. Enter the name and number and click on **ACCEPT**.

**EDIT** — If you click on this button, the Warrior Entry Screen will appear, allowing you to edit any name and number that you wish.

**DELETE** — Highlight the name and number you wish to delete, then click on this button.

**MODEM SETTINGS** — If you click on this button, the Modem Setting Screen will appear. Select your settings for Modem Type, Com Port and Baud Rate, then click on **ACCEPT**.

Note: If your com port uses a non-standard IRQ (for instance, if you have an internal modem), you should select the appropriate IRQ before you click on **ACCEPT**.

You will also be able to read your Modem Init. String, but if you wish to add a new modem type, you must exit the game and do so in DOS by typing **EDIT MODEM.LST**.

**QUICK HELP** — As you move your cursor around, a brief description of each section of the screen will appear here.

**BACK** — Click this button to return to the Transport Selection Screen.

**DIAL** and **ANSWER** — Because one player must click on **DIAL** and the other one on **ANSWER**, you should decide beforehand who will do what. If you both click the same button, a dialog box will appear indicating that the line is busy.

Note: You might wish to disable Call Waiting by attaching the disabling code to the beginning of the phone number. (Normally this code is “\*70” or “#70”; check with your local telephone service provider for more information.)

Once the connection is made, you will be taken to the Game Selection Screen.

**QUIT** — Click this button to exit *MercNet* and retreat to the safety of your operating system.

### SELECT COMMUNICATIONS PORT SCREEN

If you choose **Null Modem** to play via direct cable link between two players, the Select Communications Port Screen will appear.

**BACK** — Click this button to return to the Transport Selection Screen.

**ACCEPT** — Highlight the com port you wish to use and then click here. You will then be taken to the Game Selection Screen.

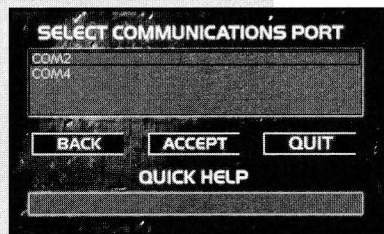

**QUIT** — Click this button to exit *MercNet* and retreat to the safety of your operating system.

**QUICK HELP** — As you move your cursor around, a brief description of each section of the screen will appear here.

### GAME SELECTION SCREEN

After you have chosen a transport and finished with its setup screen, the Game Selection Screen will appear.

**ROOMS** — Listed here are the Pilots' Lounge, where anyone looking for a game can talk to other MechWarriors, and Ready Rooms, where you can find out which warriors have joined certain games. Highlight the Ready Room of the host whose game you wish to play, then click **JOIN**.

Note: The columns to the right of the Pilots' Lounge or Ready Room will indicate the maximum number of players allowed in that room and how many positions are available.

**MERCENARIES** — If you highlight a Ready Room, then the callsigns of the warriors joining that mission will be listed here.

**COM** — This area serves as a communication link between warriors. Click in the smaller bottom section and type your message, then press **Enter** to send it to everyone in the same room or lounge as you. All messages will appear in the larger top section.

**QUICK HELP** — As you move your cursor around, a brief description of each section of the screen will appear at the bottom of the screen.

**BACK** — Click this button to return to the Transport Selection Screen.

**JOIN** — Click this button to join a Pilots' Lounge or Ready Room.

**HOST** — Click this button if you wish to host a game. Note: Only those warriors with an original Mercenaries CD in their CD drive can host a game.

**QUIT** — Click this button to exit *MercNet* and retreat to the safety of your operating system.

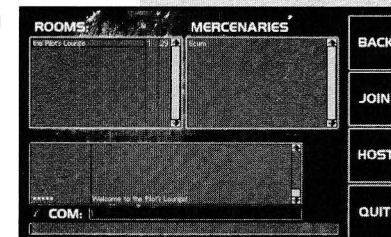



## MISSION SETUP SCREEN

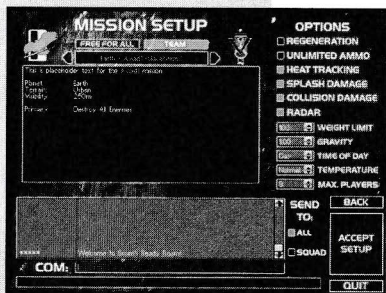

The Mission Setup Screen offers choices of missions and battle conditions. Because the privilege of making choices is reserved solely for game hosts, this screen only appears if you choose to host a game. Other warriors may offer suggestions and debate the host's wisdom, but in the end they must agree to abide by his or her conditions (or join another mission).

Note: If you choose to join a game, rather than host, the Mission Information Screen will appear instead.

**FREE FOR ALL** — Click here and then use the left or right scrolling arrow to see a list of free-for-all missions in which you will battle other MechWarriors.

**TEAM** — Click here and then use the left or right arrow to scroll through a list of team missions in which you and members of your squad will face a rival squad. Note: The host may select squad logos for both teams. To change the logos, click the on-screen logo, then select a squad from the pull-down list and click **OK**.

**COM** — This area serves as a communication link between warriors, and is invaluable during mission setup especially if you're playing on teams. Click in the smaller bottom section and type your message; then press **Enter** to send it to all the warriors who have joined the mission. Messages that other warriors send to you will appear in the larger top section.

**QUICK HELP** — As you move your cursor around, a brief description of each section of the screen will appear at the bottom of the screen.

**OPTIONS** — The following options allow you to shape the style of combat by implementing or avoiding certain aspects of 'Mech warfare:

**REGENERATION** — If this option is chosen, warriors can rejoin combat after being destroyed. Press the **Spacebar** to resurrect your 'Mech.

**UNLIMITED AMMO** — If this option is chosen, all warriors are provided with an inexhaustible supply of ammunition (i.e., missiles, machine guns, autocannons and Gauss rifles).

**HEAT TRACKING** — If this option is chosen, 'Mechs are affected by the heat they naturally generate and are susceptible to overheating. If not selected, 'Mechs are unaffected by heat.

**SPLASH DAMAGE** — If this option is chosen, 'Mechs will sustain damage from weapons, ammo or missiles exploding nearby. If not selected, 'Mechs are immune to this damage.

**COLLISION DAMAGE** — If this option is chosen, 'Mechs will be damaged by falling or colliding with other objects. If not selected, 'Mechs are immune to this damage.

**RADAR** — If this option is chosen, 'Mechs are equipped with radar that allows them to locate, track and target other warriors automatically. If not enabled, targeting must be done manually (by moving the target reticle over the enemy 'Mech and pressing the letter **Q**).

Note: If this option is enabled, **F2** will toggle this option ON and OFF while in battle.

**WEIGHT LIMIT** — This option allows the host to determine the maximum weight limit for each 'Mech, from 25 to 100 tons.

**GRAVITY** — The gravity of battle sites can be set to any number from 0.25 to 4.0, altering the effectiveness of jump jets and the speed of 'Mechs.

**TIME OF DAY** — This option allows the host to determine when the mission will begin: dawn, day, dusk or night.

**TEMPERATURE** — This option allows the host to determine how quickly 'Mechs will heat up and cool down; the choices are Cold, Normal and Hot.

**MAX. PLAYERS** — This option indicates the maximum number of players who can participate in this mission.

**BACK** — Click this button to return to the Game Selection Screen.

**ACCEPT SETUP** — Once all participants have agreed on the conditions of battle, click this button to proceed to the Squads Screen.

**QUIT** — Click this button to exit *MercNet* and retreat to the safety of your operating system.





## MISSION INFORMATION SCREEN

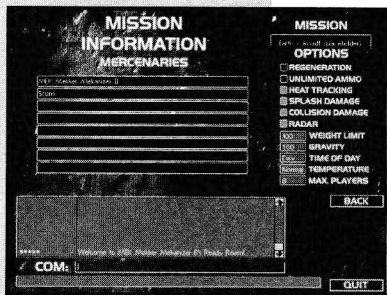

This screen shows the mission and conditions being selected by the host, and only appears if you choose to join a game. When the host is finished establishing the mission conditions, the Squads Screen will appear.

Note: If you choose to host a game, the Mission Setup Screen will appear, rather than this one.

**COM** — This area serves as a communication link between warriors, and is invaluable during mission setup especially if you're playing on teams. Click in

the smaller bottom section, type your message and press **Enter** to send it to all who have joined the mission. Messages that others send to you will appear in the larger top section.

**QUICK HELP** — As you move your cursor around, a brief description of each section of the screen will appear at the bottom of the screen

**MISSION** — The name of the mission chosen by the host is shown here.

**OPTIONS** — Listed here are the mission conditions established by the host. These options can only be changed by the host. Note: You can let the host know your preferences by communicating via **COM**.

**BACK** — Click this button to return to the Game Selection Screen.

**QUIT** — Click this button to exit *MercNet* and retreat to the safety of your operating system.

## SQUADS SCREEN

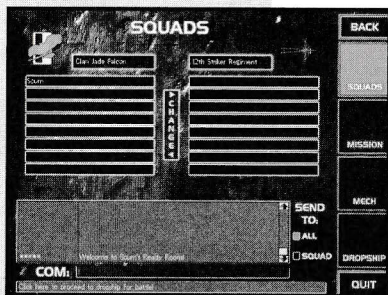

This screen allows warriors in a team mission to identify their squad affiliations once the conditions of the battle have been accepted.

Warriors are randomly divided into two teams. If you wish to betray your squad and switch to the enemy, click the **CHANGE** button. Note: you do not need to highlight your name, since you can only change your own affiliation.

Note: In free-for-all missions, warriors can select their own logos to be displayed on their 'Mechs. To change your logo, click the on-screen logo, then select a squad from the list and click **OK**.



**COM** — This area serves as a communication link between warriors. Click in the smaller bottom section and type your message, then press **Enter** to send it to all the warriors who have joined the mission. Messages that other warriors send to you will appear in the larger top section.

Note: If you are playing a team mission, you may send messages to all warriors engaged in the mission or to your squad only; click either the **Send to All** or **Squad** box to specify your communication link.

**QUICK HELP** — As you move your cursor around, a brief description of each section of the screen will appear at the bottom of the screen.

**BACK** — If you are hosting a game, this button will return you to the Mission Setup Screen. If you are joining a game, this button will return you to the Game Selection Screen.

**SQUADS** — Clicking this button has no effect because you are already in the Squad Selection Screen.

**MISSION** — Click this button to enter the Mission Summary Screen, where you will see a final summary of the mission.

**'MECH** — Click this button to enter the 'Mech Selection Screen, where you can choose your 'Mech configuration.

**DROPSHIP** — Click this button to enter the DropShip Launch Screen where you can indicate that you are ready to engage the enemy.

**QUIT** — Click this button to exit *MercNet* and retreat to the safety of your operating system.

## MISSION SUMMARY SCREEN

This screen gives the final summary of the mission. It lists the mission name and briefing, and the conditions of combat.

**OPTIONS** — Listed here are the mission conditions established by the host. If you would like any of the conditions changed, this is your last chance to voice your opinion by communicating via **COM**.

Note: For descriptions of the remaining buttons, see the "Squads Screen" section.

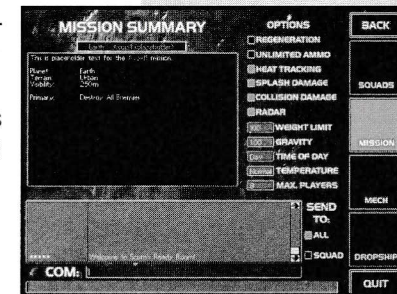



## 'MECH SELECTION SCREEN

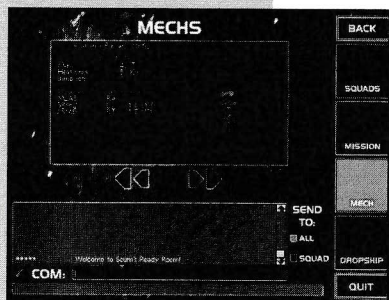

With widespread warfare breaking out in the Inner Sphere, tech support has been reduced to simple repairs. As a result you will not be able to build your own 'Mech as you could in *MechWarrior 2* and *Ghost Bear's Legacy*. You can, however, select a chassis and some variants. It is also possible for you to design a 'Mech for *MercNet* in the Mercenaries Instant Action 'MechLab.

Click on the outer arrows to scroll through the various 'Mech chassis; click on the inner arrows to scroll through the alternate configurations of 'Mechs. Click on the 'Mech description for a list of all the 'Mechs that are available.

Note: For descriptions of the remaining buttons, see the "Squads Screen" section.

Note: If you select a Mercenary logo, only Mercenary 'Mechs are available. Clan logos are only available for Clan 'Mechs.

## DROPSHIP LAUNCH SCREEN

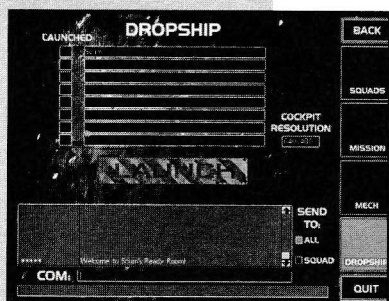

This screen lists the callsigns of all the warriors and allows you to launch into the MercNet mission. If the box next to a player's name is lit up, that player has clicked the **LAUNCH** button and is ready for battle. If you have clicked **LAUNCH** and the box next to your name is not lit or if the **LAUNCH** button is disabled, then you should review the mission options by going back to the Mission Summary Screen because one of several possibilities may have occurred:

- The host has made some changes.
- You have not accepted the changes to the mission.
- Your 'Mech is now invalid because the host has changed the parameters of the mission.
- The host has selected an invalid option for that particular mission.
- Another warrior has joined the mission or someone has changed squads.

When all warriors have clicked the **LAUNCH** button and lit boxes appear next to all names, everyone will be transported to the selected planet to commence combat.

**COCKPIT RESOLUTION** — You can choose between 320x200, 640x480 and 1024x768 by clicking to cycle

through the choices. The lower the resolution, the faster the gameplay.

**BACK** — If you are hosting a game, this button will return you to the Mission Setup Screen. Otherwise it returns you to the Game Selection Screen.

Note: For descriptions of the remaining buttons, see the "Squads Screen" section.

## MISSION RESULTS SCREEN

This screen gives information about the mission just completed, including the score for each call-sign and who completed the mission successfully.

## ADVANCED MERCNET FEATURES

You can take advantage of the following new features while you are engaged in a MercNet mission:

- After your 'Mech is destroyed (if the Regeneration option is not selected), you can still track other warriors by pressing the **Spacebar** to toggle through the warriors' callsigns and by pressing **Ctrl** and the **Arrow Keys** to maneuver your camera.
- You can chat with other warriors while on the battlefield by pressing **Ctrl+F1** or **B** to access a window in which to type your message. After typing your message, press **Enter** to send it to all warriors; in a team mission you can send it to your squad by pressing **Ctrl+F** or to your enemies by pressing **Ctrl+E**. Press **Esc** to abort.
- You can also chat with specific warriors while on the battlefield. The function keys **F2** through **F8** are assigned to individual warriors. Press **Ctrl+F?** (the key corresponding to the warrior with whom you wish to chat), then type your message and press **Enter**. Press **Esc** to abort.
- Once you have been destroyed and you flee from combat, you can still chat with players on the battlefield (from your game only) via the Mission Results Screen.

## Troubleshooting

Up-to-date troubleshooting information is available in the Technical Help file.

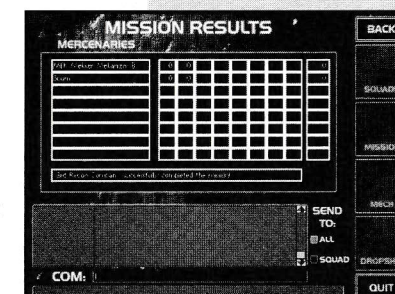

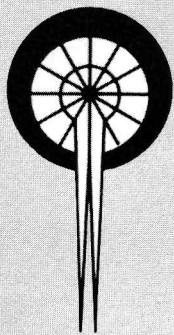

ComStar

## THE FIRST CIRCUIT OF COMSTAR (CREDITS)

### PRODUCTION

**Director**  
JACK MAMAIS

**Producer**  
TIM MORTEN

**Associate Producer**  
MATT CANDLER

**Asset Manager**  
DAIVA VENCKUS

### PROGRAMMING

**Lead Programmer/  
3-D Programmer**  
BILL FERRER

**Shell Programmer**  
JOHN PECK

**Artificial Intelligence  
Programmer**  
JOHN KEATING

**Multiplayer Programmer**  
DAN KEGEL

**Windows 95 Programmers**  
HENRY YU  
SMITH SURASMITH

**RMG Programmer**  
JOHN KEATING

**Assistant Multiplayer  
Programmer**  
CHRIS THOMAS

**Installer**  
BILL DUSHA  
FRANKIE TAN

### DESIGN

**Lead Game Designer**  
DUSTIN BROWDER

**Written by**  
DUSTIN BROWDER

**Associate Game Designer**  
KEN HULLETT

**Assistant Game Designer**  
MASON DEMMING

**Additional Writing by**  
SACHA HOWELLS

**RMG Designed and  
Implemented by**  
KEN HULLETT  
JOHN KEATING

**Intro Movie Script by**  
ZACK NORMAN

### FASA

**Fasa Contact**  
TOM DOWD

**Original BattleMech  
Designs by**  
DANA KNUTSON  
JAMES NELSON  
STEVE VENTERS

**BattleTech Background  
Material by**

MIKE STACKPOLE  
BRENT CARTER  
ROB CRUZ  
EVAN JAMESON  
RODNEY KNOX  
SAM LEWIS  
BRYAN NYSTUL  
MICHAEL PELLICCIOTT  
BOY PETERSON  
DIANE PIRON-GELMAN  
CHRISTOPHER HUSSEY  
LAURIE MAIR  
GENE MARCIL  
STEPHANE MATIS

**BattleTech Universe  
Creators**

JORDAN WEISMAN  
L. ROSS BABCOCK III

**Fasa Senior Editor**  
SHARON TURNER-  
MULVIHILL

### ART

**3-D Art and Animation,  
'Mech Builder and Sim Art  
Direction**

J.J. FRANZEN

**3-D Geometry and  
Animation**  
SEAN KINNEAR

**Shell Design**  
SEAN KINNEAR

**2-D Art and Animation and  
Sim Art Direction**  
JERRET LLOYD FARMER

**Add'l Sim Art Direction**  
DANNY MATSON

**3-D Animation and Movies**  
TIM HOFFMAN

**Intro Movie**  
EQUINOXE  
ANDY CHUNG  
ANTHONY FUNG  
BRIAN HEINS  
ARYEH RICHMOND  
SEAN RO

**Shell Art Direction and  
Creation**  
EQUINOXE  
ANDY CHUNG  
ANTHONY FUNG  
BRIAN HEINS  
ARYEH RICHMOND  
SEAN RO

**Additional Shell Models**  
ALAN IGLESIAS

### SOUND

**Audio Director**  
MATT CANDLER

**Sound Design, Bitchin'  
Betty and Cinematics Mix  
Created at:**  
SOUNDELUX MEDIA LABS

**Sound Design and Mix**  
SCOTT MARTIN GERSHIN

**Bitchin' Betty Editing**  
GREGORY J. HAINER

**Asset Management**  
HALIMA K. GILLIAM

**Digital Mastering and File  
Conversions**  
KEVIN FOWLER

**Sound Design and  
Direction**  
BIG FAT KITTY  
PRODUCTIONS  
BILL BLACK

**Add'l Casting and Directing**  
BILL BLACK

**Original Compositions**  
JEHUN HWANG

### Voices

Allision Zie, Beverly  
Bremers, Bill Black, Bill  
Ferrer, Bruce Reed, Chacko  
Sonny, Chad Findley,  
Clynell Jackson, Collette  
Freedman, Daiva Venckus,  
Danny McBride, David  
Greenspan, David Hayter,  
David Prokop, Don Mercer,  
Dustin Browder, Gary  
Newton, Graeme Finlayson,  
Hillary Black, J.J. Franzen,  
Jack Mamais, Jason Wong,  
Jay Ploussard, Jean Powell,  
Jennifer Morrison, Jerrett  
Farmer, Jim Riordan, John  
Busse, John Charles Peck  
Jr., John Keating, Josh  
Gerhardt, Kat Cressida,  
Kate Romero, Ken Hullett,  
Lisa Labon, Matt Candler,  
Michael Pace, Murali  
Tegulapalle, Paul Garnica,  
Peter Byrne, Red Broad,  
Riaz Mecklai, Robert  
Berger, Robert Biehn,  
Robert Kramer, Roy Joe  
Lee, Rue Hon, Ryan  
McNairy, Sean Kinnear,  
Steve Scott, Tara Emerson,  
Tim Hoffman, Tim Morten

**Add'l Audio Engineering**  
MICHAEL SCHWARTZ

### QUALITY ASSURANCE

**QA Manager**  
DAVE ARNSPIGER

**Sr. QA Project Lead**  
TIM VANLAW

**QA Project Leads**  
JASON WONG  
RUE HON

**Beta Test Liaison**  
ROBERT BERGER

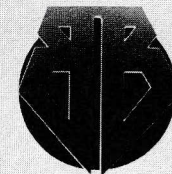

Team Banzai

**Bug Database Manager**

MATTHEW PAUL

**Mercs Test Team**

MARK BURNDORF  
GIOVANNI CASTELLO  
JUDITH CHLIPALA  
JOHN CIBULSKI  
TERRY COSSAR  
JONATHAN EUBANKS  
TODD HILL  
SCOT KRAMARICH  
JOE LACKO  
TANYA LANGSTON  
KARIN LEWIS  
CLIFF MARASCHINO  
SAM NOURIANI  
HENRY SHEEN  
WALTER URTEAGA  
TONY VILLALOBOS  
KELLY WAND

**QA Project Lead for MercNet**

DAVE OSPER

**MercNet Test Team**

BRIAN C. DIGGS  
BRIAN DEAN JENNINGS  
TIM O'GORMAN  
RICK OMORI  
GERALD PACIELLO  
CHARLES SHIA

**Special Thanks to:**

JON DOELLSTEDT  
INDRA GUNAWAN  
MARK HARWOOD  
GINA SWANSON  
JAMESON WANG

**MANUAL****Documentation Manager**

MIKE RIVERA

**Copywriter**

SACHA HOWELLS  
LORRAINE SUZUKI



*"I've always had a violent temper. In school, teachers used to call me a sociopath. Today I'm making the big bucks, doing something I love. Who's the sociopath now?"*

— Laura Newman, Tri-M™ Graduate

**NOTES****Layout**

LORRAINE SUZUKI

**Cover Art**

RON GRAENING

**Cover 'Mech**

TIM HOFFMAN

**SPECIAL THANKS**

Howard Marks, Alan Gershenfeld, Frank Evers, Brian Kelly, Bobby Kotick, Scott Lahman, Tom Dowd, Chad Findley, John Lemberger, Trey Watkins, Kelly Rogers, John Spinale, Josh Resnick, Stephen Crane, Natalie Deschartes, Dave Arnsperger, Ray Choi, Chris Campbell, Chacko Sonny, John Lafluer, John Mamais, Larry Goldberg, Chris Hewish, Kerstine Johnson, Elizabeth Capps, Steve Wilsey, Jean Powell, George Rose, Bob Pettit, Danny Matson, Sean Vesce, Sarah Hanlon, Zack Norman, Tim Vanlaw, Steve Morris, Lewis Peterson, Michael Schwartz, ALL INTERNAL BETA TESTERS, and all the others at ACTIVISION who helped us create this game.



## NOTES

### COPYRIGHT:

The enclosed software product is copyrighted and all rights are reserved by Activision, Inc. It is published exclusively by Activision, Inc. The distribution of this product is intended for the use of the original purchaser only and for use only on the computer system specified. Lawful users of this program are hereby licensed only to read the program from its medium into memory of a computer solely for the purpose of executing the program. Copying (except for one backup copy on those systems that provide for it), duplicating, selling, or otherwise distributing this product is a violation of the law. This manual and all other documentation contained herein are copyrighted and all rights are reserved by Activision, Inc. These documents may not, in whole or in part, be copied, photocopied, reproduced, translated, or reduced to any electronic medium or machine-readable form without prior consent, in writing, from Activision, Inc. Willful violations of the Copyright Law of the United States can result in civil damages of up to \$50,000 in addition to actual damages, plus criminal penalties of up to one year imprisonment and/or a \$10,000 fine. In addition, violations of the Copyright Law of other jurisdictions may result in civil damages and, in certain circumstances, criminal penalties.

© 1996 Activision, Inc.

MechWarrior, BattleTech, BattleMech and 'Mech are registered trademarks and MechWarrior 2: Mercenaries, MercNet and Tri-M are trademarks of FASA CORPORATION. © 1996 FASA CORPORATION. All rights reserved. Used with permission.

Uses Smacker Video Technology. Copyright © 1994 by Invisible, Inc. d.b.a. RAD Software.

Activision is a registered trademark of Activision, Inc. © 1996 Activision, Inc. All rights reserved.

All other trademarks and trade names are the properties of their respective owners.

Product Marketing Team: Eric Johnson, Bob Pettit, Henry Siegel, and Frank Pape.



Narhal's Raiders