



# MARIO PARTY 5

INSTRUCTION BOOKLET



NINTENDO AUSTRALIA PTY. LTD.  
Scoresby Industrial Park, 804 Stud Road,  
Scoresby Victoria 3179 Australia  
<http://www.nintendo.com.au>  
NEW ZEALAND AGENT MONACO CORPORATION LTD.  
10 Rothwell Avenue, Albany, Auckland





**WARNING: PLEASE CAREFULLY READ THE PRECAUTIONS BOOKLET INCLUDED WITH THIS PRODUCT BEFORE USING YOUR NINTENDO® HARDWARE SYSTEM, GAME DISC OR ACCESSORY. THIS BOOKLET CONTAINS IMPORTANT SAFETY INFORMATION.**

**IMPORTANT SAFETY INFORMATION: READ THE FOLLOWING WARNINGS BEFORE YOU OR YOUR CHILD PLAY VIDEO GAMES**

### **WARNING - Seizures**

- Some people (about 1 in 4000) may have seizures or blackouts triggered by light flashes, such as while watching TV or playing video games, even if they have never had a seizure before.
- Anyone who has had a seizure, loss of awareness, or other symptom linked to an epileptic condition should consult a doctor before playing a video game.
- Parents should watch when their children play video games. Stop playing and consult a doctor if you or your child have any of the following symptoms:

Convulsions	Eye or muscle twitching	Loss of awareness
Altered vision	Involuntary movements	Disorientation

To reduce the likelihood of a seizure when playing video games:

1. Sit or stand as far from the screen as possible.
2. Play video games on the smallest available television screen.
3. Do not play if you are tired or need sleep.
4. Play in a well-lit room.
5. Take a 10 to 15 minute break every hour.

### **WARNING - Repetitive Motion Injuries**

Playing video games can make your muscles, joints or skin hurt after a few hours. Follow these instructions to avoid problems such as Tendinitis, Carpal Tunnel Syndrome or skin irritation:

- Take a 10 to 15 minute break every hour, even if you don't think you need it.
- If your hands, wrists or arms become tired or sore while playing, stop and rest them for several hours before playing again.
- If you continue to have sore hands, wrists or arms during or after play, stop playing and see a doctor.

### **WARNING - Electric Shock**

To avoid electric shock when you use this system:

- Use only the AC adapter that comes with your system.
- Do not use the AC adapter if it has damaged, split or broken cords or wires.
- Make sure that the AC adapter cord is fully inserted into the wall outlet or extension cord.
- Always carefully disconnect all plugs by pulling on the plug and not on the cord. Make sure the Nintendo GameCube power switch is turned OFF before removing the AC adapter cord from an outlet.

### **CAUTION - Motion Sickness**

Playing video games can cause motion sickness. If you or your child feel dizzy or nauseous when playing video games with this system, stop playing and rest. Do not drive or engage in other demanding activities until you feel better.

### **CAUTION - Brightness of TV Screen**

The brightness of the TV screen differs with each TV but can typically be adjusted. Always play games with the appropriate brightness setting. Excessive brightness or darkness can cause discomfort. If necessary, please refer to the instructions manual of your TV for guidance on adjusting the brightness of your TV.

### **CONTROLLER NEUTRAL POSITION RESET**

If the L or R Buttons are pressed or the Control Stick or C Stick are moved out of neutral position when the power is turned ON, those positions will be set as the neutral position, causing incorrect game control during game play.

To reset the controller, release all buttons and sticks to allow them to return to the correct neutral position, then hold down the X, Y and START/PAUSE Buttons simultaneously for 3 seconds.





*This seal is your assurance that Nintendo has reviewed this product and that it has met our standards for excellence in workmanship, reliability and entertainment value. Always look for this seal when buying games and accessories to ensure complete compatibility with your Nintendo Product.*



Thank you for selecting the MARIO PARTY™ 5 Game Disc for your NINTENDO GAMECUBE® System.

Please read this instruction booklet thoroughly to ensure maximum enjoyment of your new game. It also contains important warranty and hotline information. Always save this book for future reference.



**THIS GAME SUPPORTS SIMULTANEOUS GAME PLAY WITH ONE, TWO, THREE OR FOUR PLAYERS AND CONTROLLERS.**



**THIS GAME REQUIRES A MEMORY CARD FOR SAVING GAME PROGRESS, SETTINGS OR STATISTICS.**



Dolby, Pro Logic, and the double-D symbol are trademarks of Dolby Laboratories. Manufactured under license from Dolby Laboratories.

To play games that carry the Dolby Surround Pro Logic II logo in surround sound, you will need a Dolby Surround Pro Logic II or Dolby Surround Pro Logic decoder. These decoders are sold separately.



COPYRIGHTS OF ALL CHARACTERS AND MUSIC RESERVED BY NINTENDO. COPYRIGHTS OF GAME, SCENARIO AND PROGRAM, EXCEPT COPYRIGHTS OWNED BY NINTENDO, RESERVED BY NINTENDO AND HUDSON. © 2003 Nintendo. © 2003 HUDSON SOFT. TM, ® and the Nintendo GameCube logo are trademarks of Nintendo. © 2003 Nintendo.

# CONTENTS

<b>Dream Depot</b>	<b>6</b>
<b>Controls</b>	<b>10</b>
<b>Party Time!</b>	<b>12</b>
<b>Party Mode</b>	<b>15</b>
<b>Story Mode</b>	<b>30</b>
<b>Mini-Game Mode</b>	<b>34</b>
<b>Super Duel Mode</b>	<b>44</b>
<b>Bonus Mode</b>	<b>48</b>
<b>Options Mode</b>	<b>50</b>



## Dream Depot

In the night sky, past the moon and beyond the stars, there's a dream world known as Dream Depot, where everyone's dreams come together. This is the real land of dreams... In this land, there are Star Guards who protect the dreams of all.

One dreamy night, the Star Guards thought of something.

"Many dreams arrive here at Dream Depot every day," they said, "so... why don't we offer those with the power of dreaming a chance to visit?"

In the end, they decided to invite Mario and his closest friends because, when it comes to dreamers, nobody dreams bigger than they do!

So the Star Guards prepared for their guests' arrival by creating many fun-filled games for them to play. And that is how the story of Mario and his friends both old and new began!

## Characters

There are three additional characters to use in Mario Party 5 (see pg. 9), but they are not available in all modes.

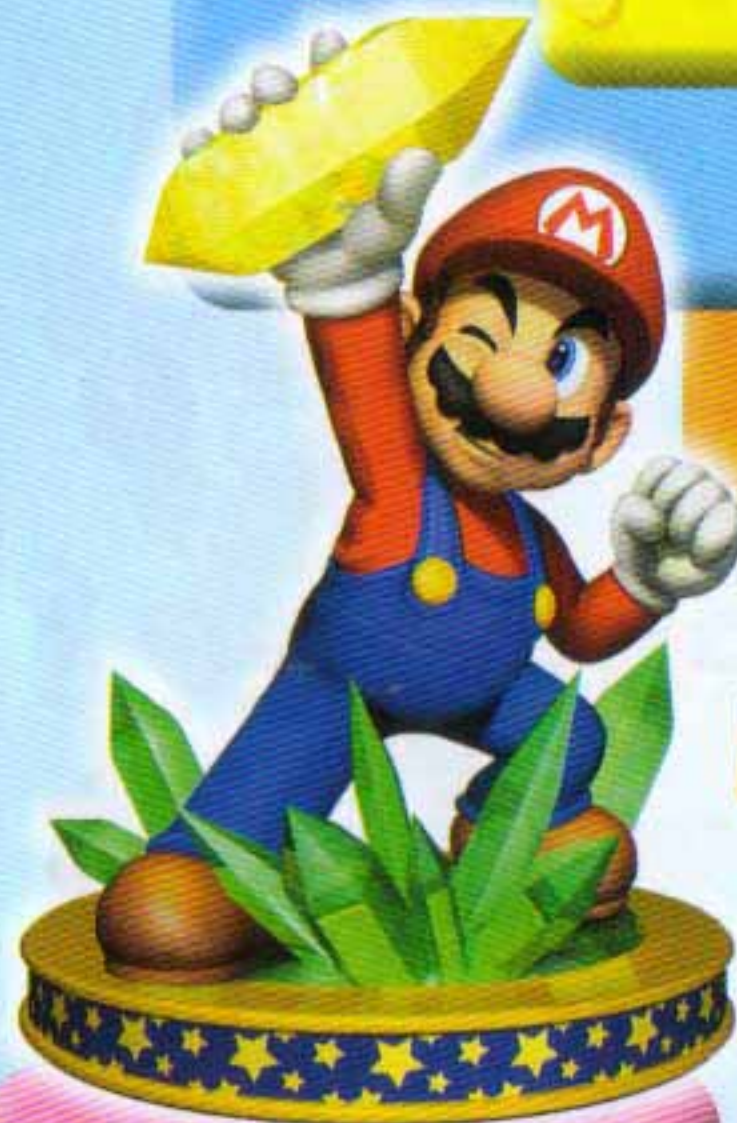

# MARIO

# LUIGI

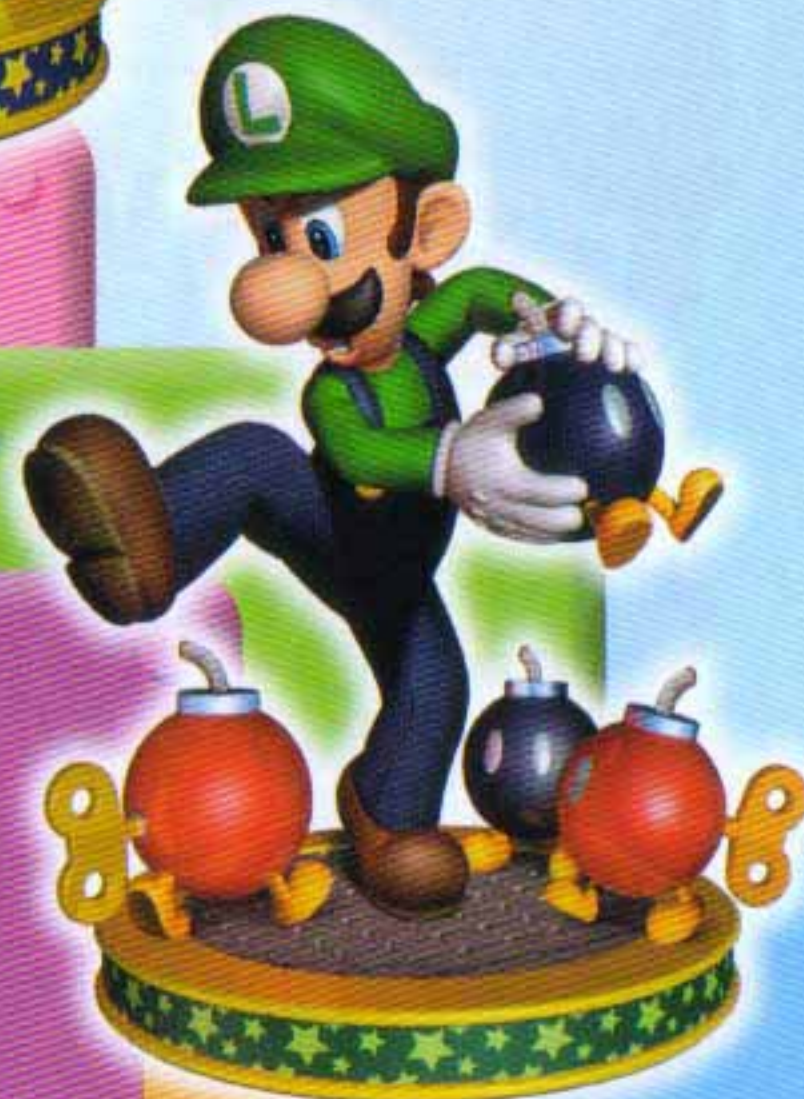





**PEACH**



**DAISY**

**YOSHI**



**NEW!**  
**TOAD**

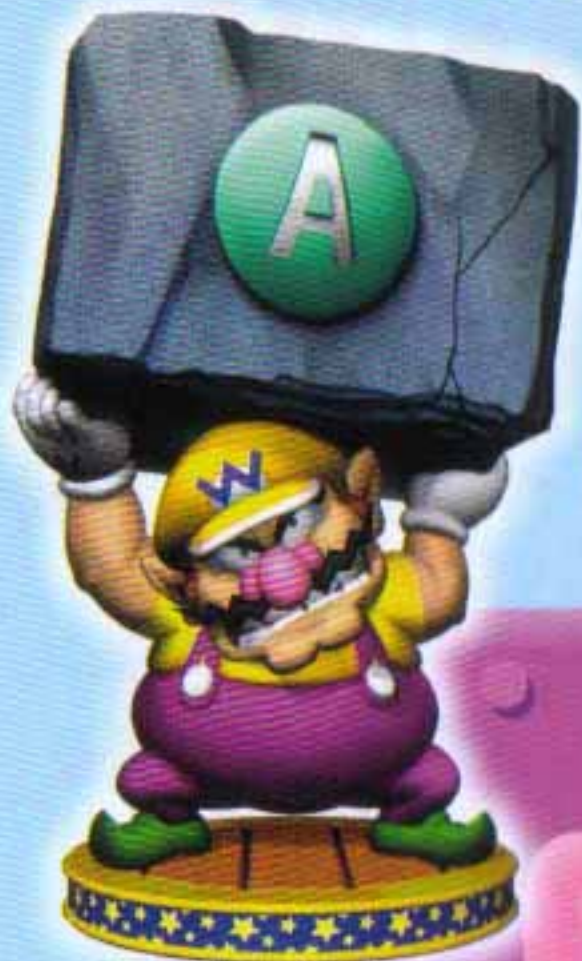

**WARIO**

**NEW!**  
**BOO**



**WALUIGI**



**NEW!**  
**MINI BOWSER**





# Controls

## START/PAUSE

Display the pause screen and change game settings. Pressing this button on the mini-game explanation screen starts the game.

## L Button

Used in mini-games. See mini-game instructions for game-specific controls.

## Control Stick

Move your character or cursor, make menu selections, and scroll the map.

## + Control Pad

Not used in this game.

## R Button

View rule explanations and controls on the mini-game explanation screen.

## Z Button

On the mini-game explanation screen, press this button to practice the mini-games.

## Y Button

Displays the board map during the game and is used in mini-games. See mini-game instructions for game-specific controls.

## X Button

Used in mini-games. See mini-game instructions for game-specific controls.

## A Button

Choose a capsule or hit the dice block.

## B Button

Cancel capsule selection, return to a previous screen, or open the item menu.

## C Stick

Not used in this game.



Press START/PAUSE during a mini-game to view the controller information for that mini-game.



# Party Time!

## ★ Getting Ready

Place the Mario Party 5 Game Disc in the Nintendo GameCube system and close the Disc Cover. Insert a Memory Card into Slot A, then turn the power ON. (Press START/PAUSE to skip the opening movie).



## ★ Memory Card Information

Mario Party 5 requires 5 blocks on your Memory Card. You can save up to 3 games on a single Memory Card.

### Playing for the First Time

Press START/PAUSE on the title screen to access the File selection screen. Choose one of the three save files, then enter a name. After confirming the name, select the file and choose Play.



Empty Save Data File

Story Mode Character  
Date and Time of Last Save



### Continuing from a Previous Save

If you have previous save data, choose Play from the options. You can save data in the Party Mode during the game. In the Story Mode, you can save your progress once you've cleared a board. If you lose, your data is saved automatically. In both modes, if you start another game and save it, your save data from the first game will be lost. Be careful!



### Copying and Erasing Data

To copy save data, select the file that you want copied and choose "Copy" from the menu. Next, choose where to save the copied data and confirm.



To erase save data, select the file that you want erased, choose "Erase" from the menu, then confirm.



## CAUTION!

- Refer to your Nintendo GameCube Instruction Booklet for more information about formatting Memory Cards and saving data.
- Do not remove the Memory Card, press the RESET Button, or turn the power off while saving. Doing so can damage your save file, and it can also cause damage to your Memory Card.





# Party Mode

## ★ Game Modes



### Party Mode

Up to four players can challenge each other in this mode. Compete in a Battle Royal or team up for a Team Match! See pg. 15 for more details.



### Story Mode

Battle against Bowser and the Mini Bowsers, Bowser's triple-trick treat! This mode is for one player only. See pg. 30 for more details.



### Mini-Game Mode

Play all of the mini-games you have unlocked! See pg. 34 for more details.



### Super Duel Mode

Design and battle custom fighting machines. This mode is for one or two players. See pg. 44 for more details.



### Bonus Mode

Play three exciting bonus games, Mario Party-style! Beach Volleyball, Ice Hockey, and Card Party await. See pg. 48 for more details.



### Options Mode

Set sound and rumble settings in this mode. See pg. 50 for more details.

## ★ Party Mode Rules

The rules are easy: **whoever has the most stars at the end wins.** To get stars, you need to win coins in the mini-games. Then use your winnings to grab more stars on the board than your opponents.

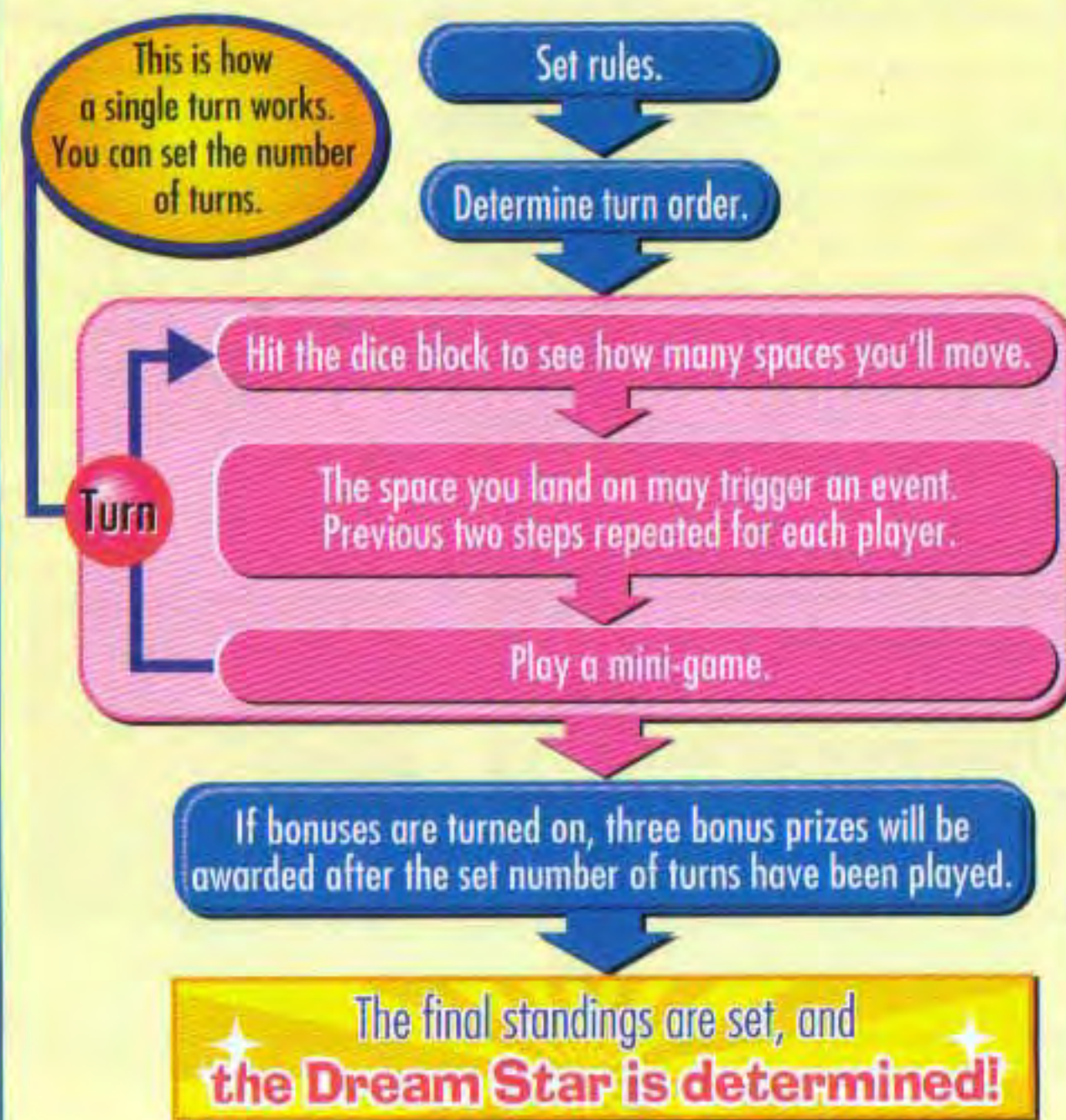

### Rules Explanation

There's a tutorial that explains each rule and how it affects game play. Before setting the rules in Party Mode, we recommend referring to the tutorial at least once.







# Rule Settings

## Rules

You can play Party Mode two ways:

**Battle Royal** Four players compete against each other.

**Team Match** Two teams of two players each duke it out. Teams compete to get the most coins and stars.

Continue with the A Button. **A** Go back with the B Button. **B**

## Set Number of Players

Four players will always participate in a game. If there are fewer than four human players, the remaining players are controlled automatically.

## Choose Character or Team

Choose the character you want to use with the cursor. Then choose a character for each CPU player as well. Set the ability of the CPU character to Easy, Normal, or Hard. When playing a Team Match, press left or right on the Control Stick to set the teams.



## Choose Board Map

Select which board map you want to play. See pg. 27 for more details.

## Set Number of Turns

Set the number of turns you want the game to last. You can set it between 10 and 50 turns, in multiples of 5.

## Choose Mini-Games

Set the mini-games that can appear during the game. Choose one of the following options:

- All - All mini-games are available.
- Easy - Only easy mini-games are available.
- Action - Only action mini-games are available.
- Skill - Only difficult mini-games are available.
- Goofy - Only goofy mini-games are available.



## Set Bonus Awards

If you turn the bonuses on, then hidden blocks containing coins become available on the board map. Also, at the end of the game, three bonus prizes of one star each will be awarded to players based on their performances. See pg. 26 for more details. If you turn the bonuses off, then no bonus awards are handed out, and the winner is decided based only on the number of coins and stars earned during the game.

## Set Handicap

Set handicaps for players or teams by changing the number of stars under the characters. Tilt the Control Stick left or right to choose the character, then tilt it up or down to set the number of stars.

Once you have finished all the settings, you will see a message asking you if the settings are OK. Choose Yes to start the game or No to change the settings.

**To the Board Map!**





## Game Screen

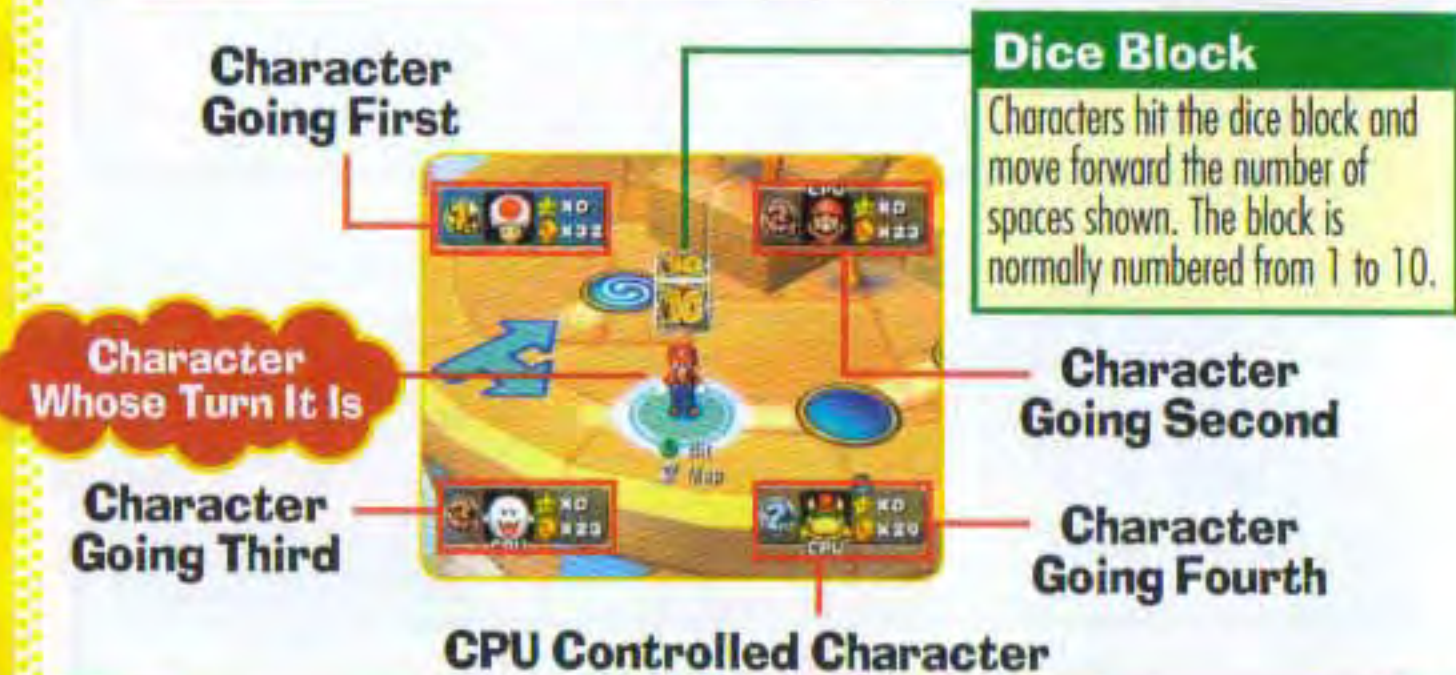

The background colour reflects the colour of the space you landed on.



During a Team Match, the background colour shows the colour of your team.



## Spaces

When you land on a space, an event takes place. The type of event depends on the type of space you landed on.



### Plus Space

These are the blue spaces. Land on one to get three coins. If you have the bonuses turned on, these spaces might also contain hidden blocks.



### Minus Space

These are the red spaces. Land on one, and you'll lose three coins.



### ? Space

If you land on one of these green spaces, a board event will begin.



## Bowser Space

There is only one of these spaces on the board map at the start of the game, but if a Bowser Capsule is drawn, another one will pop up. If you land on one of these spaces, Bowser will appear and cause a lot of trouble.



## DK Space

This space is automatically placed at random at the start of the game. If you land here, Donkey Kong appears to start all kinds of events.

### DK Roulette

Roll a higher number than Donkey Kong to get a star.

### DK Mini-Game

This is a bonus mini-game that is played with four players. There are three different games, all of which require you to collect as many bananas as you can. Later, you can trade them for coins.

### DK Bonus

Hit the dice block and get as many coins as the number you roll.



## The Board Map



### Capsule Machine

This machine dispenses capsules. You do not need to exchange any coins to get capsules. There are times when capsules are not available, and a message will appear when this is so. At any one time you can hold up to three capsules. See pg. 20 for details.

### Junctions

When you reach a junction, use your Control Stick to choose the direction in which you want to move.

### Stars

When you land on a star space, you can pay 20 coins to take the star. Keep in mind that the star spaces change every time a player gets a star.

Spaces with board events, junctions, and stars are not like other spaces. Your character will stop momentarily for the event and continue moving afterward.





# Capsules

To use a capsule, select it before hitting the dice block. Most capsules cost you coins to use on yourself, while others do not.



## Movement Capsules

Space Symbol	Capsule Type And Cost to Use on Yourself
	<b>Mushroom</b> 5 Coins Adds an extra dice block.
	<b>Super Mushroom</b> 10 Coins Adds two dice blocks.
	<b>Cursed Mushroom</b> 5 Coins Limits the numbers on the dice block to 1 through 5.
	<b>Warp Pipe</b> 10 Coins A Warp Pipe appears that swaps your place with that of another player.
	<b>Klepto</b> 10 Coins Klepto appears and moves you to another player's space.
	<b>Bubble</b> 10 Coins Allows you to move forward 10 spaces but burns up all of your remaining capsules.
	<b>Wiggler</b> 20 Coins Wiggler takes you to the next star space.





## Coin Capsules

Space Symbol	Capsule Type And Cost to Use on Yourself
	<b>Hammer Bro.</b> 5 Coins A Hammer Bro. appears and takes 10 coins from whoever lands on that space.
	<b>Coin Block</b> 5 Coins Gives 10 coins to whoever lands on that space.
	<b>Spiny</b> 5 Coins Spiny appears and takes 10 coins from an opponent chosen by the roulette wheel.
	<b>Paratroopa</b> 10 Coins Paratroopa appears and takes coins from every opponent.
	<b>Bullet Bill</b> 10 Coins Ride Bullet Bill the number of spaces on the dice block and take 30 Coins from each opponent you pass.
	<b>Goomba</b> 5 Coins Goomba appears and switches coins with an opponent chosen by the roulette wheel.
	<b>Piranha Plant</b> 5 Coins A Piranha Plant appears and takes half of the coins of whoever lands on that space.
	<b>Bob-omb</b> 0 Coins A Bob-omb counts down. If it explodes, it takes 20 coins from the player on that space.
	<b>Koopa Bank</b> 10 Coins Koopa takes coins from whoever passes this space. If you stop on this space, you will get all the coins.

See pg. 22 for details on how to use these capsules.



## More Capsules

Space Symbol	Capsule Type And Cost to Use on Yourself
	<p><b>Kamek</b> <span style="float: right;">10 Coins</span></p> <p>Kamek appears to shuffle the capsules of all the players.</p>
	<p><b>Mr. Blizzard</b> <span style="float: right;">10 Coins</span></p> <p>Mr. Blizzard appears to take all of the capsules from whoever lands on that space.</p>
	<p><b>Magikoopa</b> <span style="float: right;">10 Coins</span></p> <p>Magikoopa appears to switch capsules with an opponent chosen by the roulette wheel.</p>
	<p><b>Ukiki</b> <span style="float: right;">10 Coins</span></p> <p>Ukiki appears, takes the capsules of a player chosen by the roulette wheel and throws them around the board.</p>
	<p><b>Lakitu</b> <span style="float: right;">10 Coins</span></p> <p>Lakitu appears to steal capsules from your opponents.</p>

## Even More Goodies

Space Symbol	Capsule Type And Cost to Use on Yourself
	<p><b>Tweester</b> <span style="float: right;">15 Coins</span></p> <p>Tweester appears to change the location of the star space.</p>
	<p><b>Duel</b> <span style="float: right;">10 Coins</span></p> <p>Battle in a 1-vs.-1 mini-game for stars, coins or both.</p>
	<p><b>Chain Chomp</b> <span style="float: right;">15 Coins</span></p> <p>A Chain Chomp appears to take coins or a star from the player of your choice.</p>
	<p><b>Bones</b> <span style="float: right;">0 Coins</span></p> <p>Protects from a Chain Chomp attack.</p>
	<p><b>Bowser</b> <span style="float: right;">0 Coins</span></p> <p>Bowser appears and changes one red space to a Bowser space.</p>
	<p><b>Chance</b> <span style="float: right;">20 Coins</span></p> <p>You will either receive, give away, or exchange coins and stars. All of this is decided by the roulette wheel.</p>
	<p><b>Miracle</b> <span style="float: right;">0 Coins</span></p> <p>Nothing happens with one, but collect three to steal all the stars from the player in first place.</p>

## Using Your Capsules



Depending on the type of capsule, you can place most capsules on the board up to ten spaces ahead of your character. You can use capsules on yourself, but this will cost you coins, with the amount depending on the capsule. There are even advantages to simply holding on to capsules.



When placing a capsule on the board, you can choose any space that's not a star space or a ? space.







# Playing Mini-Games!



A mini-game will begin at the end of each turn once all the players have finished moving. The type of mini-game will change depending on the colours of the spaces where players have stopped. Before the mini-game begins, green spaces will randomly change to blue or red spaces.

## 4-Player Mini-Games (All players land on same-coloured spaces).



In these 4-player free-for-alls, defeat your rivals or be the last player standing to win.

## 1-Vs.-3 Mini-Games (One player lands on a different colour).

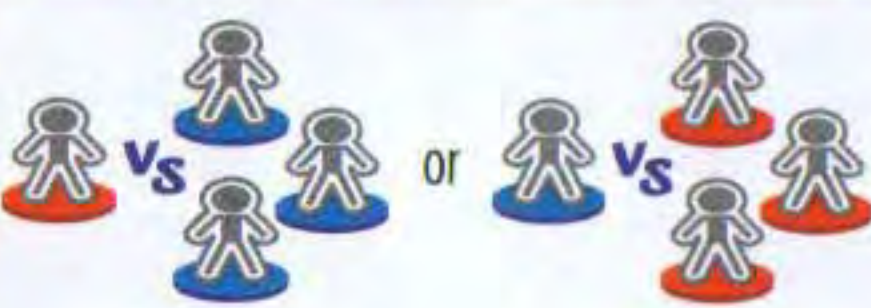

In 1-vs.-3 mini-games, one player must prevail over all others to win.

## 2-Vs.-2 Mini-Games (Two players land on same-coloured spaces).



In these 2-on-2 mini-games, players must team up and work together to achieve victory.

### Team Match Mini-Game Types

When playing Team Match, 1-vs.-3 mini-games will not appear. Also, in 2-vs.-2 mini-games, players will play according to their own teams, regardless of the colours of the spaces that they land on.

# Mini-Game Roulette



The mini-game roulette will determine which game will be played. Games that have not yet been played will appear as question marks on the wheel.

# Mini-Game Explanation Screen

Teams are split left and right depending on how the teams are formed.



Party guide

Mini-game instructions

You can learn the rules, view the controller information, and even practice the mini-games.

- R Button** **L Button** View controller information and advice.
- Z Button** Practice the mini-game.
- START/PAUSE** Start the mini-game.

There is an option to bypass the mini-game explanation screen in the pause menu. See pg. 28 for more details.

# Results



Prizes for winning mini-games are always paid in coins. The winning player or team receives coins.





## Deciding the Dream Star

### The Last Five Turns

Before the last five turns begin, Bowser will ask the player in last place to spin the roulette wheel to determine a new rule for the last five turns.



### Additional Rules

- Blue and red spaces give or take three times the number of coins as usual.
- A capsule event starts on every space.
- All red spaces turn into Bowser spaces.
- The number of star spaces rises to five.

With the new rule, there's always a chance for a comeback! Hang in there!

## Final Results



The game ends at the completion of the last turn. If the bonuses are turned on, stars are awarded to the winner of each bonus category.

**Mini-Game Star** For the player who got the most coins in the mini-games.

**Coin Star** For the player who got the most coins in the game.

**Happening Star** For the player who landed on the most ? spaces.

The Dream Star is awarded to the player with the most stars after all is said and done. If multiple players have an equally high number of stars, the star champion with the most coins wins.

If there's still a tie, players will hit a dice block. Whoever gets the highest number is the winner.



## Boards

### Toy Dream

Difficulty ★☆☆



Someone spilled a toy box! There's a train, some toy soldiers, and all kinds of other fun tricks on this board.

### Rainbow Dream

Difficulty ★☆☆



Rainbow bridges connect the board's four areas: cloudy, rainy, snowy, and sunny. Enjoy the beautiful scenery!

### Pirate Dream

Difficulty ★★☆☆



Treasure-hunting and exotic locales make up this board. Search for a large cavern with a waterfall, enjoy the treasure-hunting events, and get swept away by a waterfall to another part of the board. It's bound to shiver yer timbers!

### Undersea Dream

Difficulty ★★☆☆



It's 10,000 laughs under the sea! With colourful coral reef, a sunken ship, Cheep Cheeps, and even a friendly whale, it's a deep-sea dive only Mario Party can deliver!



## Future Dream

Difficulty ★★★



Teleport from space station to space station as you marvel at the wonders of the universe in this outer-space race for the stars! It's one small party for man and one giant party for mankind!

## Sweet Dream

Difficulty ★★★



It's an adventure certain to make you drool! The whole board is sweet, sugary delight, and the birthday present and candy-toss events are just the icing on this cake!

## Pause Menu

Press START/PAUSE during the game to open the pause menu. Here, you can change some of the game settings.

## Changing Control

You can change the control settings for each character. Pick a character and then choose CPU or Player. You can also change the CPU character's skill level here. Use this if you want to change a normal player to a CPU player for a while.



## Mini-Game Explanation Screen

You can change the settings so that you can either view or skip the mini-game explanation screen.

## CPU Mini-Game

You can choose VIEW or SKIP depending on whether you want to watch mini-games involving only computer-controlled characters.

## Mini-Game Pack

Use this setting to control which mini-games appear on the mini-game roulette wheel. You can choose from All, Easy, Action, Skill, and Goofy mini-game packs.

## Rumble Settings

Change the Rumble Feature settings here. Press the A Button to switch between ON and OFF.

## Message Speed

Use this setting to change the speed at which the messages are displayed on screen. Choose from Fast, Normal, or Slow.

## Save

- Don't Save - Game data will not be saved.
- Save This Turn - Game data is saved at the end of the current turn.
- Save Every Turn - Game data will be saved at the end of each turn.

## Quit

Choose this to quit the game in progress and return to the main menu. We recommend that you save before quitting the game.



# Story Mode

Bowser has somehow wormed his way into Dream Depot and is threatening to ruin all the dreams. The Star Guards need you to stop him. Are you up to the task of saving Dream Depot?

## You Versus Bowser!

To stop Bowser, you'll battle his minions, the Mini Bowsers. On each board, take all of their coins to win. Like in Party Mode, players hit the dice block and move the number of spaces, and events occur depending on the spaces everyone lands on. But this mode differs in a couple of ways.



### Rule Settings

You can choose the characters and skill levels as explained on the next page. However, the rules are set as follows:

Rules: Battle Royal      Turn Count: 20 Turns  
Bonus: Off                  Handicap: None

When your last turn is finished, if even one Mini Bowser has any coins left, your game is over.

### Board Map

The board maps in the Story Mode are the same as the board maps in the Party Mode. However, there are differences. The placement of the spaces and junctions are different. Also, you cannot choose the board maps on which you are playing—you must play through them in the order set for you.

## ★ Rule Settings

### Choose Character

Use the cursor to select the character you want to use in the Story Mode.

Continue with the A Button.



Go back with the B Button.

### Choose Level

Choose a difficulty level from the following options: Easy, Normal, and Hard. The skill level of your opponents depends on the setting you select.



### Set Mini-Games

Set the type of mini-game you want to play the same way you do in the Party Mode.



Once you have finished adjusting the settings, you will be asked if the settings are OK. Choose Yes to start the game or No to change the settings.



## Board Map





## Introducing the Mini Bowsers!



Your rivals in Story Mode are the Mini Bowsers: M. Bowser G, M. Bowser B, and M. Bowser R. After your turn, all three Mini Bowsers hit the dice block at the same time and move.



## Spaces

In addition to the plus spaces and minus spaces, there are even more spaces. (For information on plus and minus spaces see pg. 18.) Land on one of these spaces, and all kinds of events begin.



### DK Space

If a Mini Bowser lands on this space, Donkey Kong takes half of his coins away. If a player lands on this space, DK awards him or her 10 coins.



### Bowser Space

If a Mini Bowser lands on this space, he gets 5 coins. If a player lands on this space, Bowser takes half of his or her coins.



### VS Space

Land on this space to trigger a mini-game. Your character will always battle against the remaining Mini Bowsers in a 1-vs.-3, 2-vs.-2, or a 1-vs.-1 duel mini-game. The number of coins awarded depends on the type of mini-game. In a 2-vs.-2 mini-game, a CPU controlled-character is partnered with the player.



### ? Spaces

If any player lands on these spaces, a board event will begin.



## Duel Time!



Unlike in the Party Mode, a mini-game is not played at the end of every turn. Instead, when you pass a Mini Bowser or stop on the same space as a Mini Bowser, a 1-vs.-1 duel mini-game begins. The player who lands on the space starts the duel mini-game. If a player lands on a space with two or more Mini Bowsers, the player can choose which Mini Bowser to battle. The losing player has to pay a set amount of coins.



## The Last Five Turns...



When there are five turns left, Bowser appears and announces the current standings. From then on, losing a mini-game costs twice as much.



# Mini-Game Mode



In the Mini-Game Mode, you can play the mini-games in a variety of ways.

## ★ Setting the Rules



This is the same as in the Party Mode.

### How to Play?

There are six different ways to play in the Mini-Game Mode. So many mini-games, so little time!



## ★ Six Ways to Play

### Free Play

See pg. 36 for details.

Conditions to play: Play one or more mini-games. Play any of the mini-games on the list!

### Mini-Game Battle

See pg. 36 for details.

Conditions to play: Play one or more 4-player, 1-vs.-3, or 2-vs.-2 mini-games. Compete in a tournament setting. Compete to win a set number of mini-games. Mini-games are decided by the roulette wheel.

### Mini-Game Circuit

See pg. 37 for details.

Conditions to play: Play one or more 4-player, 1-vs.-3, 2-vs.-2 mini-games, a Bowser mini-game, and a duel mini-game. Play a mini-game, then the winner gets to hit the dice block and move forward. The first to reach the finish line wins.

### Mini-Game Decathlon

See pg. 38 for details.

Conditions to play: Play all ten of the mini-games listed on page 38. Compete in a decathlon-competition including ten mini-games. Earn points in each of the ten mini-games. The player with the highest total after all ten have been played wins.



### Mini-Game Wars

See pg. 39 for details.

Conditions to play: Play one or more 4-player mini-games. There is a field of 19 hexagonal tiles. Win a mini-game to capture a tile. If you sandwich opponents' tiles vertically, horizontally or diagonally, you'll capture those tiles. The player with the most tiles at the end wins.



### Mini-Game Tournament

See pg. 40 for details.

Conditions to play: Play one or more duel mini-games. Compete in only duel mini-games. Not only is an overall winner crowned, there is even a match to determine 3rd and 4th places!





## ★ Free Play

### 1. Select a Mini-Game

Select a mini-game from the ones that appear. Scroll through the genres by pressing the L and R Buttons. If you're playing alone and choose a 1-vs.-3 or 2-vs.-2 mini-game, you will need to pick the teams.



### 2. View Mini-Game Rules

With the Explanations ON setting, you will see the rules, controls, and hints before each mini-game. If you set it to OFF, you'll go straight to the mini-game.



## ★ Mini-Game Battle

### 1. Set Number of Wins

Choose from 3, 5, or 7 to determine the number of wins required.



### 2. Play Mini-Game Roulette

Choose the type of mini-game, and choose the teams if necessary. The actual mini-games are chosen by the roulette wheel.



### 3. View Star Chart

The star chart displays the winner after each mini-game. Then the roulette wheel appears, and the next mini-game is decided. This repeats until one player or team wins the required number of mini-games.



## ★ Mini-Game Circuit

The Mini-Game Circuit progresses in the following manner:

### 1. Play the Mini-Game

The mini-game roulette wheel decides which mini-game to play. Next, the use of capsules is decided. The winner's capsule works, and the loser's capsule vanishes.



### 2. Hit the Dice Block

Only the winners of each mini-game can hit the dice block. After the winner stops moving, any of the following events can occur depending on which area colour the player lands on.



**Normal Area:** This area is grey, and no events take place.



**Battle Area:** This area is blue, and a duel mini-game is played. The loser is moved back the number of spaces shown on the dice block.

**Bowser Area:** This area is red, and a Bowser mini-game is played by all players. Those who lose must move back as many spaces as Bowser says.

The colour of the area you land in sets the type of mini-game and the teams to play that mini-game in the same manner as the Party Mode.

### 3. Reach the Finish Line

As soon as one player reaches the finish line, the game is over. Until then, steps one and two above are repeated. If two or more players reach the finish line at the same time, a dice block will be used to break the tie. The highest number wins.







## Mini-Game Decathlon

Earn points in each of ten mini-games. The scores are totalled at the end to determine the winner.

### 1. Play a Mini-Game

The mini-games are played in the order listed below.



### 2. Earn Bonus Points

Setting records in the mini-games can earn bonus points. After each mini-game, the current standings are displayed along with each character's point totals.



### 3. See Results

After all ten mini-games are completed, the final tally is displayed. The player with the most points wins.



## Mini-Game Decathlon: Ten Mini-Games

To compete in the Mini-Game Decathlon, you must have played the following ten mini-games:

- ① Ground Pound Down
- ② Chomp Romp
- ③ Flower Shower
- ④ Leaf Leap
- ⑤ Night Light Fright
- ⑥ Dinger Derby
- ⑦ Hydrostars
- ⑧ Will Flower
- ⑨ Later Skater
- ⑩ Triple Jump



## Mini-Game Wars

Capture more tiles than your opponents!

### 1. Play Mini-Games

Compete in 4-player mini-games chosen by the roulette wheel.



### 2. Capture the Tiles

Win a mini-game to capture a tile. Move the cursor with the Control Stick, and use the A Button to select one of the flashing tiles. Sandwich an opponent's tile vertically, horizontally, or diagonally with your tiles to capture his or her tile.



### 3. See Results

Steps one and two repeat until all the tiles are captured. In the end, the player with the most tiles wins.





## ★ Mini-Game Tournament

Four players compete in a tournament setting. Not only is an overall winner crowned, there's also a match to determine 3rd and 4th place. The duel mini-games played are chosen by the roulette wheel.



### 1. Tournament Matchups

The tournament brackets are set automatically and played starting from the left.



### 2. Do the Duel

The duel mini-games are decided by the roulette wheel. Keep winning to make it to the finals. If you lose, you can battle for 3rd and 4th place.



## ★ Mini-Game List

### 4-P Mini-Games

Chimp Chase

Chomp Romp

Coney Island

Dodge Bomb

Fish Upon a Star



Flower Shower

Frozen Frenzy

Ground Pound Down

Leaf Leap

Pushy Penguins

Coin Cache\*

Dinger Derby

Fish Sticks

Hotel Goomba

Hydrostars



Later Skater

Mazed & Confused

Night Light Fright



Pop-star Piranhas

Rumble Fumble

Triple Jump

Vicious Vending\*

Will Flower



### 1-Vs.-3 Mini-Games

Beam Team

Big Top Drop

Curvy Curbs

Fight Cards



Flatiator

Heat Stroke

Mario Mechs



Mathletes\*

Quilt for Speed

Revolving Fire

Squared Away

Tube It or Lose It



\*Mini-games with an asterisk are bonus games that can earn you lots of coins.



## 2-Vs.-2 Mini-Games

Banking Coins\*

Berry Basket

Bus Buffer

Clock Stoppers

Defuse or Lose

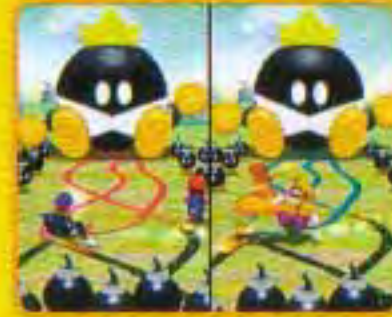

Handy Hoppers

ID UFO

Manic Mallets

Mario Can-Can

Panic Pinball

Rumble Ready

Submarathon

## Battle Mini-Games

Astro-Logical

Bill Blasters

Lucky Lineup



Random Ride

Tug-o-Dorrie

Twist 'n' Out

## DK Mini-Games

Banana Punch

Da Vine Climb

Mass A-peel



## Duel Mini-Games

Blown Away

Bound of Music

Button Mashers

Countdown Pound

Get a Rope



Head Waiter

Merry Poppings

Piece Out

Pound Peril

Pump 'n' Jump



Shock Absorbers

Shy Guy Showdown

Sky Survivor

Whomp Maze

Wind Wavers



## Bowser Mini-Games

Cage-in Cookin'

Rain of Fire

Scaldin' Cauldron



\*Mini-games with an asterisk are bonus games that can earn you lots of coins.



# Super Duel Mode



Super Duel Mode games are for one or two players. In the Super Duel Mode, you first buy parts, then take those parts to a garage to create your very own battle machine. With your battle-ready machine, you can battle other machines, battle your friend's machine, and even enter tournaments. Up to six machines can be stored on one Memory Card.

## ★ What's a Machine?

A machine is a vehicle you build from the ground up. It consists of a body type, a tire set, an engine, and a weapon. Different combinations produce different types of machines. Do you want a lighter, faster machine that has lower defensive abilities, or a heavier, slower one that has more firepower? Either way, it's up to you!

### Counter

Skolar, the Super Duel Mode guide, will show you how to get parts. You can also test drive your machine created by the parts you had in the test battle to see how you like it.



### Garage A-1 (P1)/Garage A-2 (P2)/Garage B (P3)

Build your machine, fine-tune it, and battle it here. Garage A-1 is for P1, and Garage A-2 is for P2. Garage B is for P3 and for when you import a machine from a Memory Card. (See the page on the right for more details). **When two players battle, one machine must be stored in the garage.**

### Garage Gallery

View photographs of winning machines here.

## ★ Constructing Your Machine!

### 1. Buy Parts

You earn redeemable points when you play mini-games in the other game modes, and all usable points are automatically saved.

Once at the service desk, choose shop to see the parts you can purchase. To complete a machine, you'll need to purchase at least one body type, one tire set, an engine, and a weapon.



### 2. Open The Garage

Now that you have the parts, head over to the garage. When first building your machine, and when tuning it, you will need to follow these steps.

#### The Assembly Line

Select Body

Select Tires

Select Engine

Select Weapon



#### Enter Name

Finally, enter a name for the machine. Now you're ready to test your machine!





### 3. Get Ready to Battle!

To battle other machines, select Battle Other Machines in the garage. Then, choose either Vs. Battle to battle a friend's machine or D1 Tournament to battle a CPU controlled machine (see opposite page for more details). Then, select a driver.

#### Select Driver

Once you've finished forging your ultimate battle machine and chosen the type of battle you want to fight, you need to select a driver. Initially, you can only choose from the same characters that are available in the Party Mode.



### 4. Choose Your Battle

If you choose Vs. Battle, there are three battles to choose from.

#### Battle Competition

It's an all-out assault on your opponent! Attack him until his health reaches zero.

#### Flag Competition

It's a race to capture three flags! A flag will appear somewhere on the stage, and you've got to use all means available to get there before your opponent does. After a flag is picked up, another will appear, and you get to do it all again!

#### Robo-Rabbit Competition

It's a race to shoot a rabbit-shaped robot! The first player to shoot the robo-rabbit three times wins. Use all means available to slow your opponent while also tracking down the robo-rabbit!



### 5. Auto Mode/Selecting a Battle Map

After setting the battle style, you can control your machine in Manual Mode or let the CPU handle the controls in the Auto Mode. Finally, select where you want to battle and the game begins!

## The Battle Screen



The red triangle indicates P1's location, the green indicates P2's.

#### Flag Competition



The number of flags captured appears where the health meter does in battle.

#### Robo-Rabbit Competition



The number of robo-rabbits hit appears where the health meter does in battle.

## ★ D1 Tournament

Eight custom machines, including the player's, participate in the competition. In addition to the three battle styles, the D1 tournament has three settings: Easy, Normal, and Hard.

To unlock the Flag Competition, you must first win Battle Competition on the Hard setting. To unlock the Robo-Rabbit Competition, you must beat a Flag Competition on the Hard setting.





# Bonus Mode

## ★ Card Party

Move along a game board lined with special cards looking for the coveted Star Cards. The player with the most stars at the end of the game wins.

### Rule Settings

Select the size of the field.

Select the number of players.

Select the game pieces.

Determine the order of play.

Set the starting points.

Start the game.

There are four game board sizes to choose from:

Short play: 7x7.  
Standard play: 8x8.  
Long play: 9x9.  
Longest play: 10x10.

There are seven game pieces to choose from: Mario, Luigi, Peach, Yoshi, Wario, Daisy, and Waluigi.

The starting point is always on the outside of the game board.



### Viewing the Screen



Starting Piece

1st Piece  
2nd Piece  
3rd Piece  
4th Piece  
This is the order in which they will roll the dice.

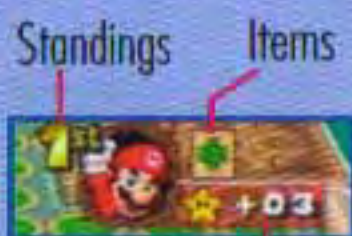

Number of Stars

### Game Flow

Roll Dice and Move.

Turn Card Over.

Once the last Star Card is turned over, the game is finished.

View Results.



The player with the most stars wins. If there's a tie, a card game begins. The first player to turn over a Star Card wins.

Certain cards start certain events. Until the last Star Card is found, the game repeats the steps on the left.

### Card Type



#### Pathway Card

Turn this over to see the pathway.

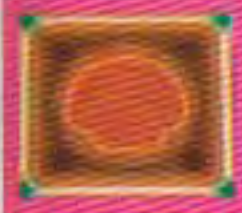

#### Item Card

Turn this over to get an item. To use the item, press the B Button before rolling.



#### Event Card

When you turn this over, any number of events could begin. Turning it over can be to your advantage or disadvantage!



#### Bowser Card

If you turn this over, either Bowser or Mini Bowser will appear and start a horrible event.



#### Star Card

Turn this over to get a Star. Sometimes, a Star Card transforms into a Ztar Card, causing you to lose a Star or more!

The Bonus Mode also holds more fun! In addition to the Card Party, there is Beach Volleyball and Ice Hockey!



# Options Mode

## ★ View Mini-Game Packs

The mini-games are sorted into categories called packs. These are All, Easy, Action, Skill, and Goofy packs. Look here if you want to know what category a particular mini-game fits into.

## ★ Set Rumble

Tilt the Control Stick left or right to turn the Rumble ON or OFF.

## ★ Set Audio / Listen to Music

Switch between Stereo, Mono, and Surround, or Listen to Music and Voices

You can listen to the game music and characters' voices. Use the L or R Buttons to switch between screens. Use the Control Stick to select the item you want to listen to.



## ★ View Records

### Mini-Game

You can view the highest score recorded for certain mini-games.

### Board Map

You can see how many times you've played each board map, the number of stars you've collected, and the characters who have won each board.

### Party Mode/Story Mode

You can see how many times you've played each board map, the number of stars you've collected, and the rank each character has earned in Story Mode.

### Mini-Game Decathlon

View the top ten finishes in the Mini-Game Decathlon.

### Super Duel

You can view the results of the Super Duel Mode.



# Notes



# Notes

# Notes



## Important

REV-A

**WARNING:** Copying of any Nintendo game is illegal and is strictly prohibited by domestic and international intellectual property laws. "Back-up" or "archival" copies are not authorized and are not necessary to protect your software. Violators will be prosecuted.

This Nintendo game is not designed for use with any unauthorized copying device or any unlicensed accessory. Use of any such device will invalidate your Nintendo product warranty. Nintendo (and/or any Nintendo licensee or distributor) is not responsible for any damage or loss caused by the use of any such device. If use of such device causes your game to stop operating, disconnect the device carefully to avoid damage and resume normal game play. If your game ceases to operate and you have no device attached to it, please contact Nintendo Customer Service.

The contents of this notice do not interfere with your statutory rights.

This booklet and other printed materials accompanying this game are protected by domestic and international intellectual property laws.

## 12 MONTH WARRANTY FOR NINTENDO GAMECUBE® (GAME DISC) REV-Q

You may only require simple instructions to correct a problem with your product, therefore we recommend the following services:

NINTENDO HELPLINE 190 224 1001

Set-up, connection and gameplay assistance together with hints and tips for a wide range of Nintendo products.

Live Games Experts available between 12 noon and 7pm, every day of the year.

Recorded information on our most popular titles available 24 hours per day.

INFORMATTEL ONLINE CALL RATE AT \$1.98 PER MINUTE INCLUDING GST  
(Calls from mobile and public phones attract a higher rate)

NINTENDO WEBSITE [www.nintendo.com.au](http://www.nintendo.com.au)  
Troubleshooting, warranty and service/repair information.

### CONDITIONS OF WARRANTY

The benefits conferred by this Warranty are in addition to all other conditions and warranties in respect of this product which the consumer may have under the Trade Practices Act 1974 of the Commonwealth of Australia and/or similar State, Territory or Country Laws.

Nintendo Australia Pty Limited warrants this GameCube (GAME DISC) to be free of defects in materials, workmanship and manufacturing to the original purchaser for a period of twelve months after the date of purchase and upon presentation of purchase receipt.

1. Nintendo Australia Pty Limited will at its option and subject to the terms and conditions stated below, repair or replace free of charge this GAME DISC or any component part, which upon examination by Nintendo Australia Pty Limited is found to be defective.

2. This Warranty shall not apply:

- (a) If the GAME DISC has been subjected to misuse, abuse, accident or want of care.
- (b) If the GAME DISC has been modified and/or tampered with.
- (c) If a repair has been made or attempted by the purchaser or their agent.
- (d) The following are not covered by this Warranty:

- (i) Liquid damage;
- (ii) Scratched or damaged discs;
- (iii) Wear and tear.

(e) If the GAME DISC fails due to causes unrelated to defective materials or workmanship.

3. Nintendo Australia Pty Limited accepts no liability pursuant to this Warranty for any cost or consequential damage or economic loss whether direct or indirect, to any person or property, arising from breakdown or failure of this product and no responsibility is to be implied or accepted over and above the replacement value of the product.

This Warranty is given by Nintendo Australia Pty Limited and no other person or organisation is authorised to vary its provisions and conditions.

Before returning a Nintendo GameCube® GAME DISC for service, contact:

Nintendo Customer Service on (03) 9730 9822  
Warranty and Repair information and all other general enquiries.  
Hours of operation: 8:30am to 5:30pm Monday to Friday (EST).

NINTENDO AUSTRALIA HEAD OFFICE  
Scoresby Industrial Park, 804 Stud Road, Scoresby Victoria 3179 Australia