

ICE CLIMBER™

INSTRUCTION BOOKLET



ACTION SERIES

Look for this seal on all software and accessories for your Nintendo Entertainment System. It represents Nintendo's commitment to bringing you only the highest quality products. Items not carrying this seal have not been approved by Nintendo, and are not guaranteed to meet our standards of excellence in workmanship, reliability and most of all, entertainment value.



Thank you for selecting the Nintendo® Entertainment System Ice Climber™ Pak.

OBJECT OF THE GAME/GAME DESCRIPTION

It's only you and an ice hammer as you make your way to the top of the mountain! If you can break through 8 levels of treacherous arctic ice, you'll reach the top of the mountain. But watch out – the Nitpicker, condors and Polar Bears don't want you up there. And they've got a bag of tricks that will block your rise to the top. There are 32 challenging peaks to scale – face them alone or with a friend.

Please read this instruction booklet to ensure proper handling of your new game, and then save the booklet for future reference.

1. PRECAUTIONS

- 1) This is a high precision game. It should not be stored in places that are very hot or cold. Never hit it or drop it. Do not take it apart.
- 2) Avoid touching the connectors, do not get them wet or dirty. Doing so may damage the game.
- 3) Do not clean with benzene, paint thinner, alcohol or other such solvents.

Note: In the interest of product improvement, Nintendo Entertainment System specifications and design are subject to change without prior notice.

2. NAMES OF CONTROLLER PARTS AND OPERATING INSTRUCTIONS

Controller 1 – Moves Popo in 1 or 2 player game

Controller 2 – Moves Nana in 2 player game

Controller 1/Controller 2* For 2 Player Game

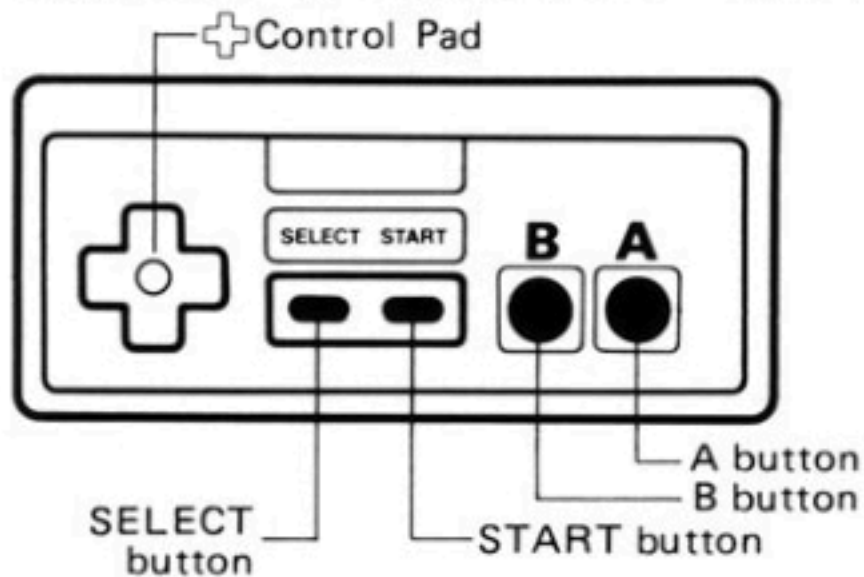

A Button

Used to break a hole through the row of ice blocks on the floor above with the hammer, and climb up onto it by jumping.

B Button

Strike with the hammer in the direction your character faces and get rid of the toppies and nitpickers.

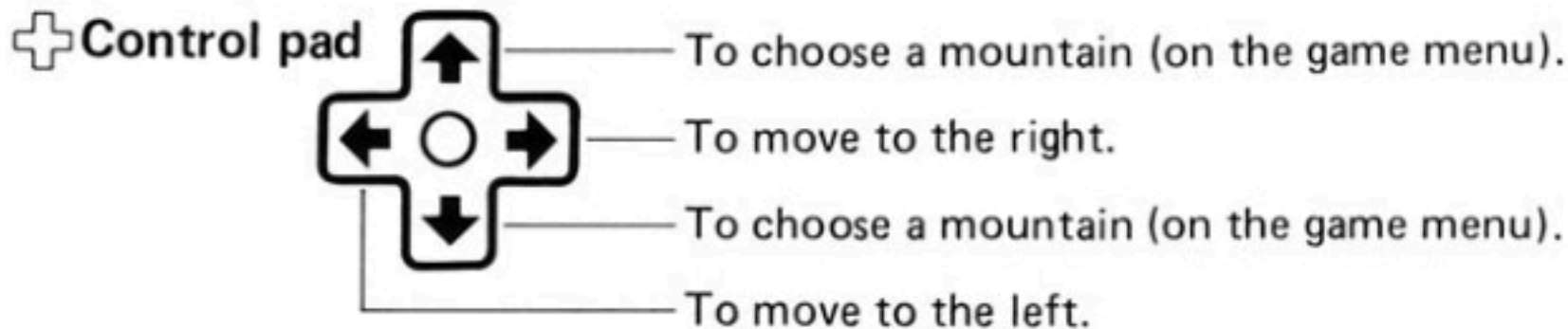



SELECT button

Move the hammer mark () to the game you wish to select from the game menu by pressing this button.

START button

Press this button to begin.

Pause:

If you wish to interrupt play in the middle of a game, press the START button. The pause tone will sound and the game will stop. Press the START button again when you wish to continue the game. The game will continue from where it left off.

* The TOP SCORE disappears once the power switch is turned OFF.

3. HOW TO PLAY

This game can either be played by 1 person with Popo or by 2 people with Popo and Nana. Using their hammers, they must break through the floor above and jump up to the next level.

[Characters]

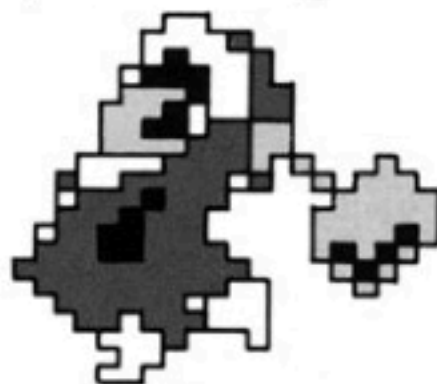

Popo



Nana

(Controller 1, blue) (Controller 2, pink)

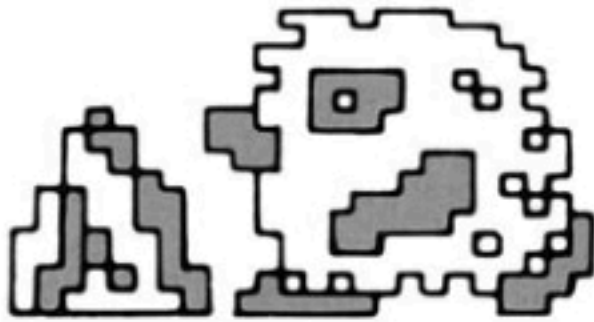

Topi

- They bring ice to fill in holes in the floors.
- If you collide with a Topi you lose a man.

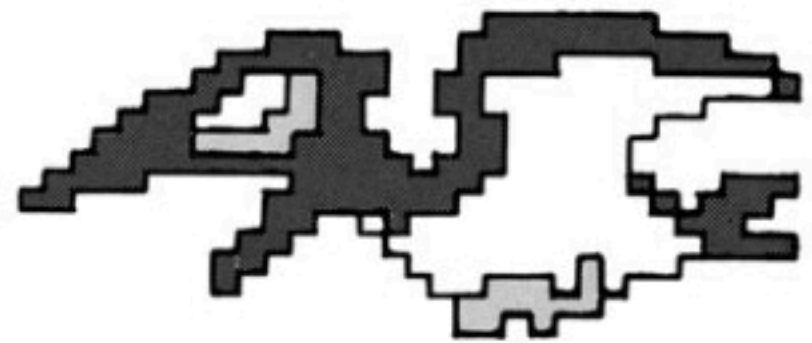

Condor

- Jump up and grab onto the Condor during the bonus round for extra points.

Nitpicker

- Always flying around Popo and Nana. If you collide with this bird you lose a man.

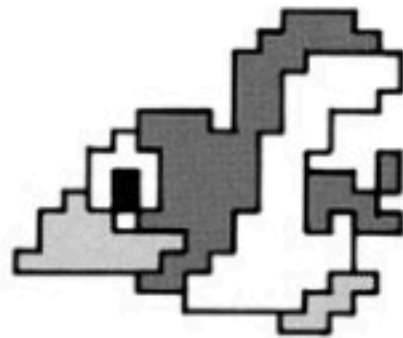

Polar Bear

- After a certain period of time, the Polar Bear comes out and pushes the floors down.



[Rules and Suggestions]



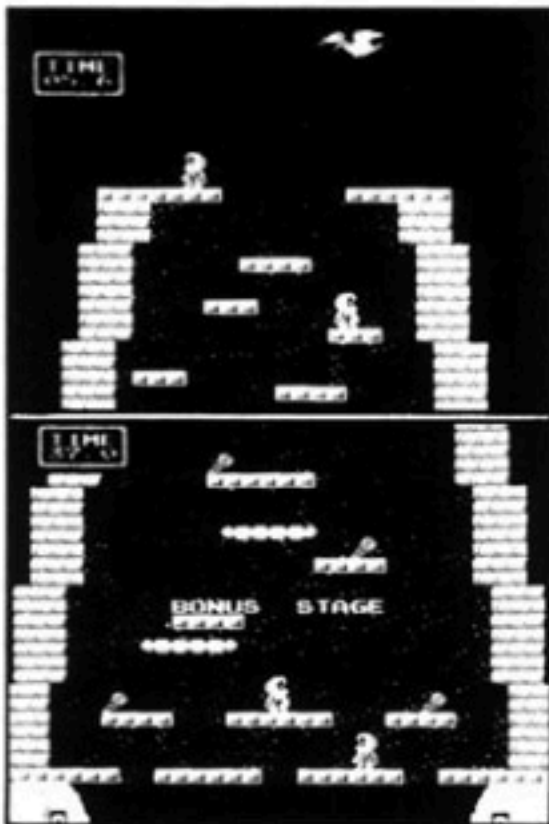

1. Use the  control pad when the game menu is displayed to enter the number of the mountain you want to climb. (MOUNTAIN XX)
 - The mountains are numbered from 1 ~ 32. You can attempt to climb any mountain, but the larger the number the more difficult the mountain is to climb.
2. When the game begins, the condor carries a vegetable up near the top of the mountain. At this point, the whole mountain is visible.
3. Break the ice blocks of the floor above and make a gap, then jump through the gap to the higher floor by pressing A button. Continue up the mountain through each floor in the same manner.
 - Time carefully and mount the moving clouds to reach the floors above.
 - Pay attention to the types of floors. Some floors will break, but others won't; while others move like a conveyor belt.
 - * Be sure to read the "tips" in this booklet.
 - * On each floor, Popo and Nana can walk off the right edge of the screen onto the left edge and vice-versa.
4. Chase away the bothersome toppies and nitpickers with the A or B button.
5. The toppies come and fill in the gaps in the floors with ice.
6. After a certain period of time, the Polar Bear comes out, jumps up and down (boom!) and pushes the screen down. At this time, any player pushed off the bottom of the screen is lost.
7. After a man is lost, the next man will appear on the screen flashing on and off. While flashing, the man cannot play. Move the man to start the game.

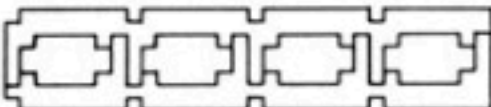
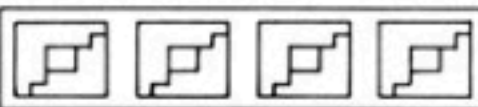
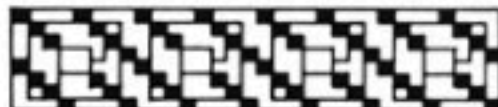

8. The screen is cleared after you arrive at the 8th floor, and you go into the bonus round.
 - The condor hid a vegetable at the beginning of the game. Get the vegetable for additional points.
 - There are 10 types of vegetables. The first bonus round always uses eggplants.
 - If the player jumps up and grabs onto the condor at the end, he or she receives bonus points.
 - The bonus round ends and the next mountain scene appears when one of the following occurs:
 - (1) When the player falls off and nobody is left on the screen.
 - (2) When the player jumps up and grabs onto the condor.
 - (3) When the timer runs out.

Tips

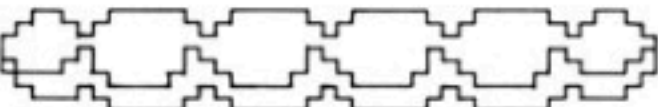
- Holes can be made more quickly where the row of ice blocks is thin.
- The floors and clouds have various characteristics. Learn the tricks and climb up quickly.

 <p>Breakable floor</p>	 <p>Unbreakable floor</p>	 <p>Unbreakable moving floor</p>	 <p>Pillar</p>
 <p>Breakable moving floor</p>	 <p>Big Cloud</p>		
 <p>Small Cloud</p>	 <p>Group of Clouds</p>		

- Getting even one ear of corn () in the bonus round adds one man; however, note that the screen only shows up to 3 men.
- In the 2 player game, the two players can either cooperate with each other and play together, or they can play against each other – bothering and tricking each other.

You lose a man by:

- Colliding with a Topi.
- Colliding with a Nitpicker.
- Colliding with the ice that a Topi brings.
- Disappearing from the screen when the Polar Bear pushes the screen down.
- In the 2 player game, if the leading player gets so far up that the other player disappears off the bottom of the screen, the lower player is lost.
- * If you fall off the screen during the bonus round, you do not lose a man.

MOUNTAIN 01	
1 PLAYER	2 PLAYER
NO BONUS †	WINNER BONUS † 3000
300x01	300x02
400x00	400x00
800x00	800x00
10x20	10x20
TOTAL	TOTAL
000500	003800

Scoring

After each mountain climb is finished, the current score is calculated.

COMPLIANCE WITH FCC REGULATIONS

This equipment generates and uses radio frequency energy and if not installed and used properly, that is, in strict accordance with the manufacturer's instructions, may cause interference to radio and television reception. It has been type tested and found to comply with the limits for a Class B computing device in accordance with the specifications in Subpart J of Part 15 of FCC Rules, which are designed to provide reasonable protection against such interference in a residential installation. However, there is no guarantee that interference will not occur in a particular installation. If this equipment does cause interference to radio or television reception, which can be determined by turning the equipment off and on, the user is encouraged to try to correct the interference by one or more of the following measures:

- Reorient the receiving antenna
- Relocate the NES with respect to the receiver
- Move the NES away from the receiver
- Plug the NES into a different outlet so that computer and receiver are on different circuits.

MEMO

.....

.....

.....

.....

.....

.....

.....

.....

.....

.....

90-DAY LIMITED WARRANTY NINTENDO GAME PAKS

90-DAY LIMITED WARRANTY:

Nintendo of America Inc. ("Nintendo") warrants to the original consumer purchaser that this Nintendo Game Pak ("PAK") (not including Game Pak Accessories or Robot Accessories) shall be free from defects in material and workmanship for a period of 90 days from date of purchase. If a defect covered by this warranty occurs during this 90-day warranty period, Nintendo will repair or replace the PAK, at its option, free of charge.

This warranty shall not apply if the PAK has been damaged by negligence, accident, unreasonable use, modification, tampering, or by other causes unrelated to defective materials or workmanship.

REPAIRS AFTER EXPIRATION OF WARRANTY:

If the PAK develops a problem after the 90-day warranty period, you may contact the Nintendo Consumer Service Department at the phone number noted above. If the Nintendo service technician is unable to solve the problem by phone, he may provide you with a Return Authorization number. You may then record this number on the outside packaging of the defective PAK and return the defective PAK freight prepaid to Nintendo, enclosing a check or money order for \$10.00 payable to Nintendo of America Inc. Nintendo will, at its option, subject to the conditions above, repair the PAK or replace it with a new or repaired PAK. If replacement PAKS are not available, the defective PAK will be returned and the \$10.00 payment refunded.

WARRANTY LIMITATIONS:

ANY APPLICABLE IMPLIED WARRANTIES, INCLUDING WARRANTIES OF MERCHANTABILITY AND FITNESS FOR A PARTICULAR PURPOSE, ARE HEREBY LIMITED TO NINETY DAYS FROM THE DATE OF PURCHASE AND ARE SUBJECT TO THE CONDITIONS SET FORTH HEREIN. IN NO EVENT SHALL NINTENDO BE LIABLE FOR CONSEQUENTIAL OR INCIDENTAL DAMAGES RESULTING FROM THE BREACH OF ANY EXPRESS OR IMPLIED WARRANTIES.

The provisions of this warranty are valid in the United States only. Some states do not allow limitations on how long an implied warranty lasts or exclusion of consequential or incidental damages, so the above limitations and exclusion may not apply to you. This warranty gives you specific legal rights, and you may also have other rights which vary from state to state.



Nintendo

PRINTED IN JAPAN

Any original instruction manuals included with this software are digital reproductions of the original printed manuals. They are as faithful as possible to those documents and feature a bare minimum of edits. Reference may be made to features that can't be used in this version of the game, or the contact information provided may no longer be valid. Some copyright information may be out-of-date. Please also note that printed manuals were not always released in multiple languages.