

Miracle Warriors™

Seal of The Dark Lord™

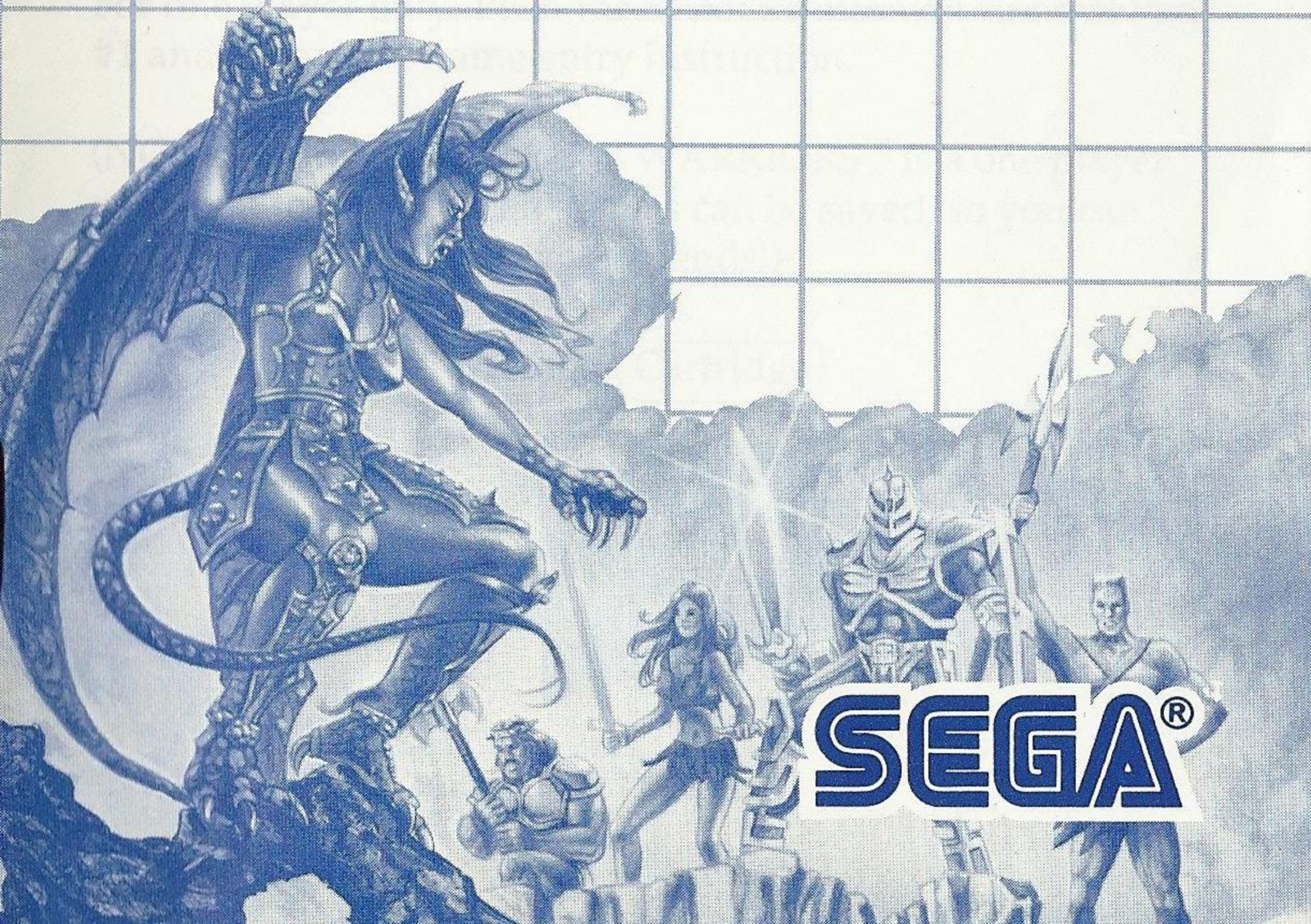

SEGA®

Miracle Warriors: Seal of The Dark Lord™

If thou be strong and noble, a mighty quest awaits thee!

After a millennium of peace, the Dark Lord Terarin hast freed herself and stolen the Golden Seal, opening Pandora's Passage to the evil dimension. Now, hoards of fearsome monsters roam the land.

Come! Follow in the footsteps of the mighty Iason and defeat the Dark Lord. Only you, the Miracle Warrior, can return the Seal to its rightful place.

Loading Instructions: Starting Up

1. Make sure the power switch is OFF.
2. Insert the MIRACLE WARRIORS™ cartridge in the Power Base (shown below) as described in your SEGA SYSTEM™ manual.
3. Turn the power switch ON. If nothing appears on the screen, turn the power switch OFF, remove the cartridge and try inserting again.

IMPORTANT: Always make sure the Power Base is turned OFF when inserting or removing your Sega Card/Cartridge.™

For one player only: Push the START Button on Control Pad #1 and follow the name entry instruction.

(NOTE: Although MIRACLE WARRIORS™ is a one player game, up to five separate games can be saved, so you can take turns playing with your friends!)

Insert Two-Mega Cartridge

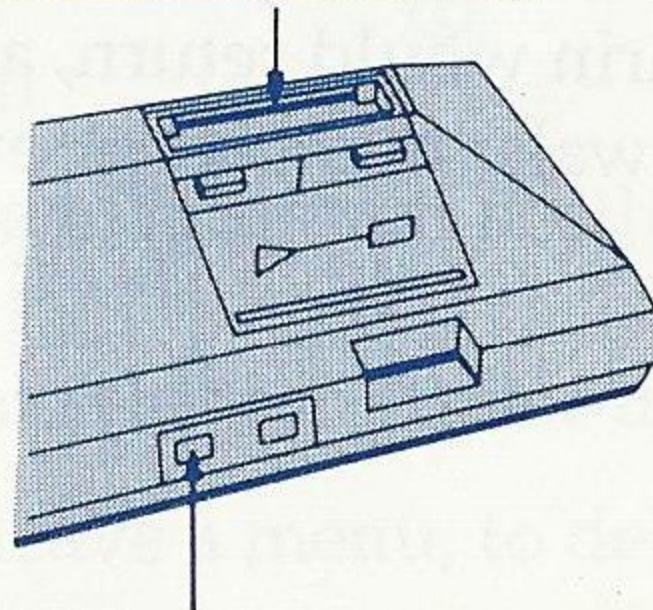

Insert Control Pad 1

The Legend of Iason

Long ago in a land of swords and sorcery, a stumbling shepherd lad named Iason unknowingly opened the Pandora Passage. Through this gateway all manner of evil creatures were let loose upon the Five Lands under the claws of the Dark Lord Terarin.

As Iason grew into a man, he watched Terarin's nightmare army devastate the Five Lands. Since it was he who had unleashed this evil, he took a vow to defeat Terarin and restore peace to his world.

Iason trained with the White Monks, learning the ways of the King's sword . . . and the magical dangers of Terarin's evil hoard. To help him on his quest, the monks gave him magical arms and armor.

After a long and valiant battle, Iason defeated Terarin and drove her into another dimension. Then, his armor glowing gold, Iason resealed the Pandora Passage.

The people of the Five Lands made him a legend. Before he went back to the life of a shepherd, Iason made a prophecy that one day Terarin would return, and that four brave warriors would awake to meet her evil challenge!

Art Thou The Miracle Warrior?

There was a time not long ago when Terarin escaped from her entrapment and, with a howl of rage that shook the world, once again unleashed her terror upon the land.

You watched the Five Lands suffer under her ruthless campaign of evil as you wandered from country to country. Then, one fine, cloudless day, your wanderings led you to a castle . . . where you learned of your true destiny.

The blood of Iason flowed in your veins. But were you the one fated to bring an end to Terarin's evil? Only time would tell as you learned the ways of magic and the sword!

Using your Control Pad or Control Stick:

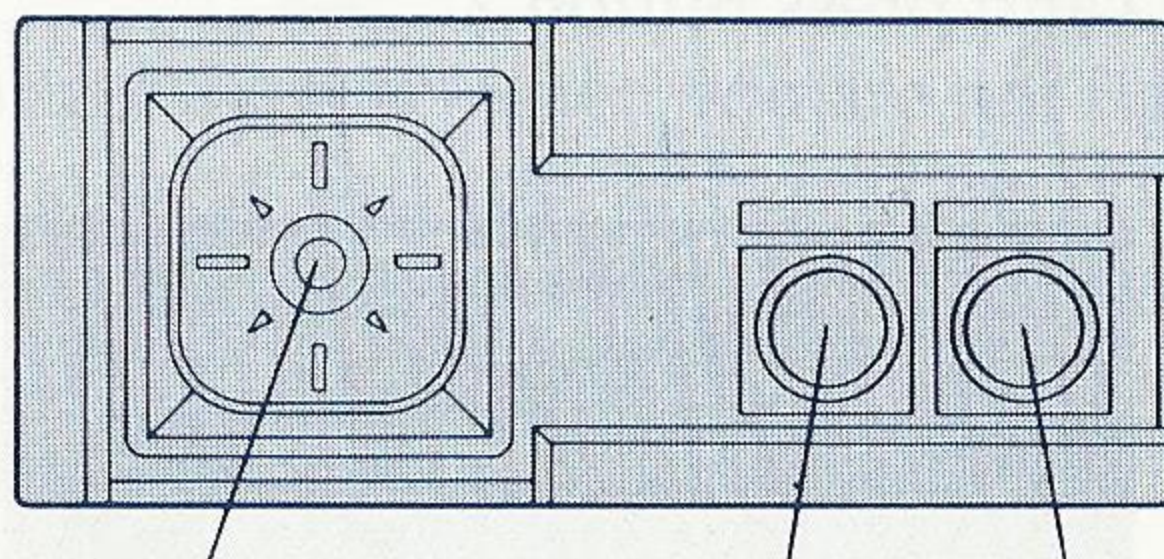

DIRECTIONAL
BUTTON
(D-Button)

BUTTON ①

BUTTON ②

D-Button: Moves white map square north, south, east or west.

Moves menu selection cursor up or down.

Button 1: To enter or leave a menu, to delete selection or to leave a village or town.

Button 2: To confirm menu item selection.

Beginning your journey

Your quest to defeat Terarin and restore the Seal shall be long and challenging. To make the beginning of your journey easier, learn well the following method of play:

Insert the MIRACLE WARRIORS™ cartridge and turn on the power base. When the title screen appears, select "START" for a new game or "CONTINUE" to continue a game you've been playing. Up to five games can be saved.

Name Entry

If you selected "START," you will see the name entry screen. Use the D-Button to select up to four letters for your name and Button 2 to confirm your selection. Then move the cursor to END and press Button 2.

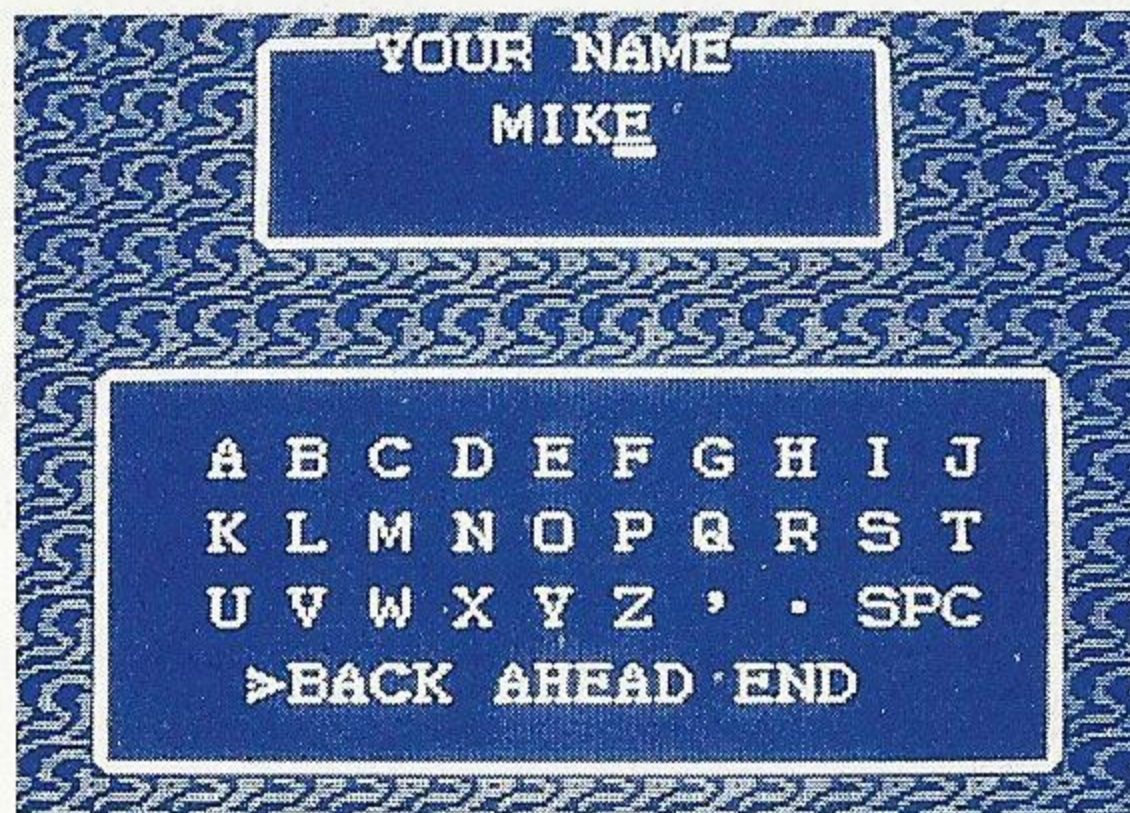

Moving Through The Five Lands

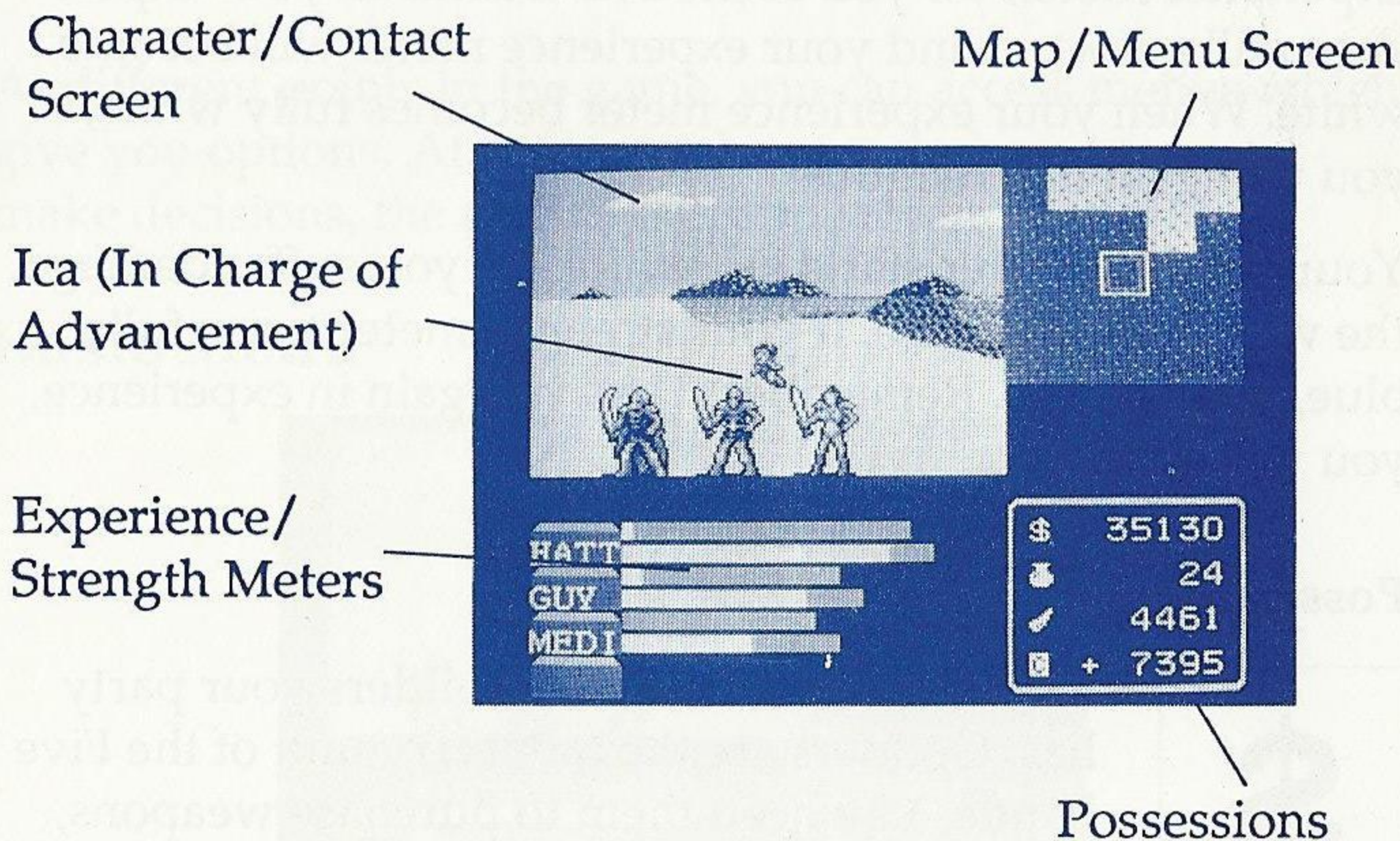

You begin your quest with this screen.

Character/Contact Screen: When you are not fighting, you and your companions will appear here. The moving background represent your character's point of view in the Five Lands. When you do battle, your foe will be seen here. Messages will also appear in this screen.

Ica: The magical fairy who makes sure messages are seen by all.

Map/Menu Screen: The white square is where you are in the Five Lands. Use your game map as a reference. One move of the white square equals one square on your game map. To move the white square north, south, east or west, use the D-Button. Your game menu will also appear here when you press Button 1.

Experience/Strength Meters: The upper blue bar is your experience meter. As you battle evil creatures, your experience will grow . . . and your experience meter will become white. When your experience meter becomes fully white, you will gain in strength.

Your strength meter starts out white. As you suffer damage, the white will decrease. If your strength meter turns fully blue, you will die. Remember . . . as you gain in experience, you will gain in strength.

Possessions:



\$: Shows the amount of Guilders your party has. Guilders are the monetary unit of the Five Lands. You need them to purchase weapons, healing herbs and special items.



POT: Herbs. Use herbs to heal yourself and your party after combat.

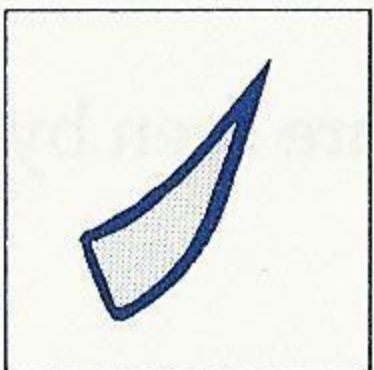

FANG: Fangs are valuable in the Five Lands. They can be sold for guilders . . . or traded for certain items!

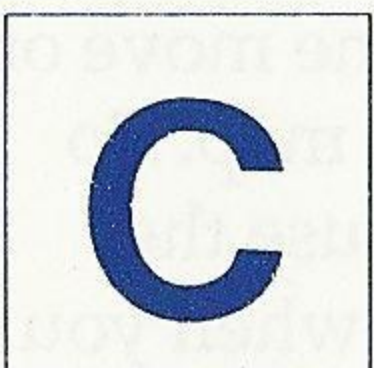

C: Character points are evidence of your worthiness in combat. Some villages will not admit you if you don't have enough character. And be careful who you slay, or your fame could decrease!

Game Menus

At different points in the game, you can access menus which give you options. At points in the game where you must make decisions, the menus will appear automatically.



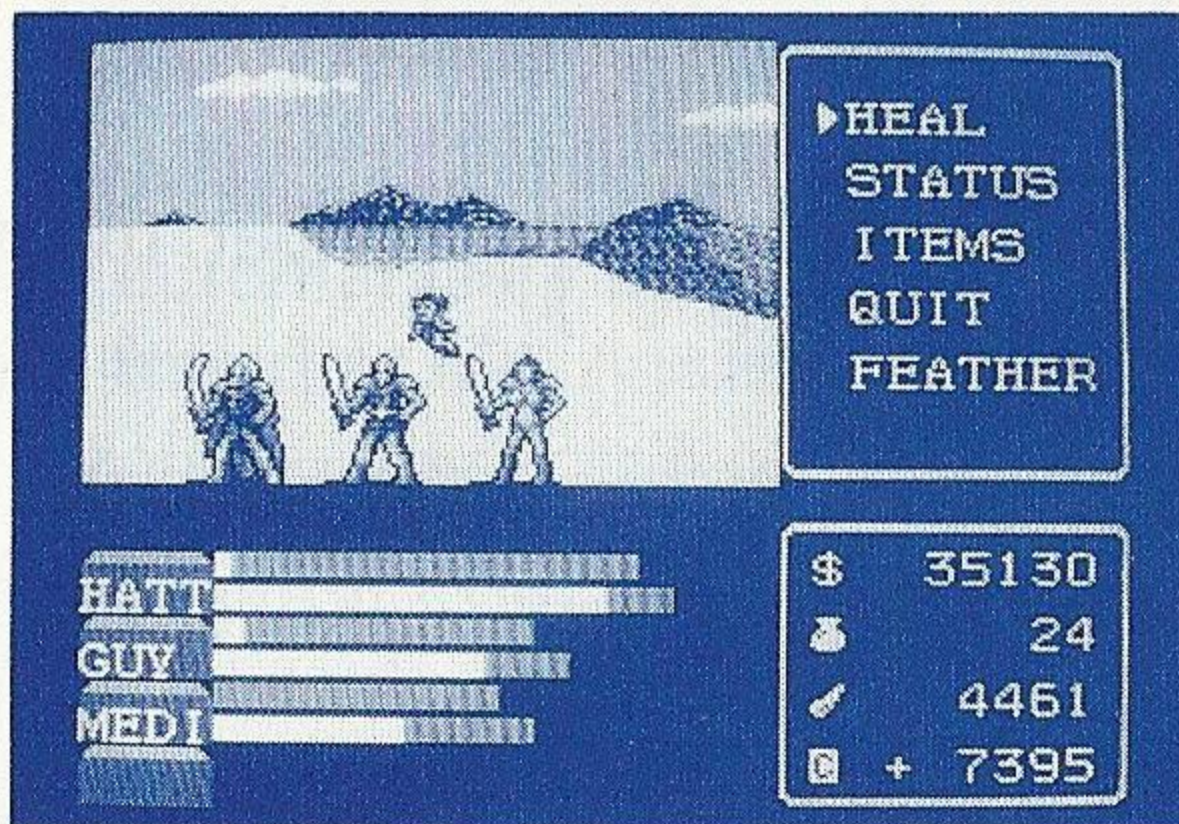





Basic Menu



You may access this menu when traveling through the Five Lands by pressing Button 1. To make a selection, use the D-Button to pick an item and press Button 2 to confirm. To cancel a selection or return to the game, press Button 1.

Heal: When you and your companion's strength has been depleted in combat, you may use this command . . . if you have herbs . . . to regain strength.

Status: Shows the strength value of you and your companions as well as the weapon types and uses left in the weapons.

	HATT	S	032	D	35		GUY	S	024	D	25
ARMS						ARMS					
	IRIS		100				TUROS		100		
	KRONOS		100				ARMOR		080		
	SHEILD		060				SHEILD		060		
	MEDI	S	012	D	13						
ARMS											

S: Attack Strength - the higher the number, the more damage done to your foes.

D: Defense Strength - the higher the number, the less damage done to you by enemies.

Weapons: If the number in the column next to the weapon reaches 0, the weapon will break and you have to find a new one. A visit to the swordsmith before this happens will put new life in your steel!

Items: Selecting ITEM will allow you to see and count the various special items you win or buy in the course of the game.

Quit: This will allow you to save a game, by selecting SAVE in the subscreen, or will let you end the game permanently by selecting the QUIT option again.

Encounter Menu

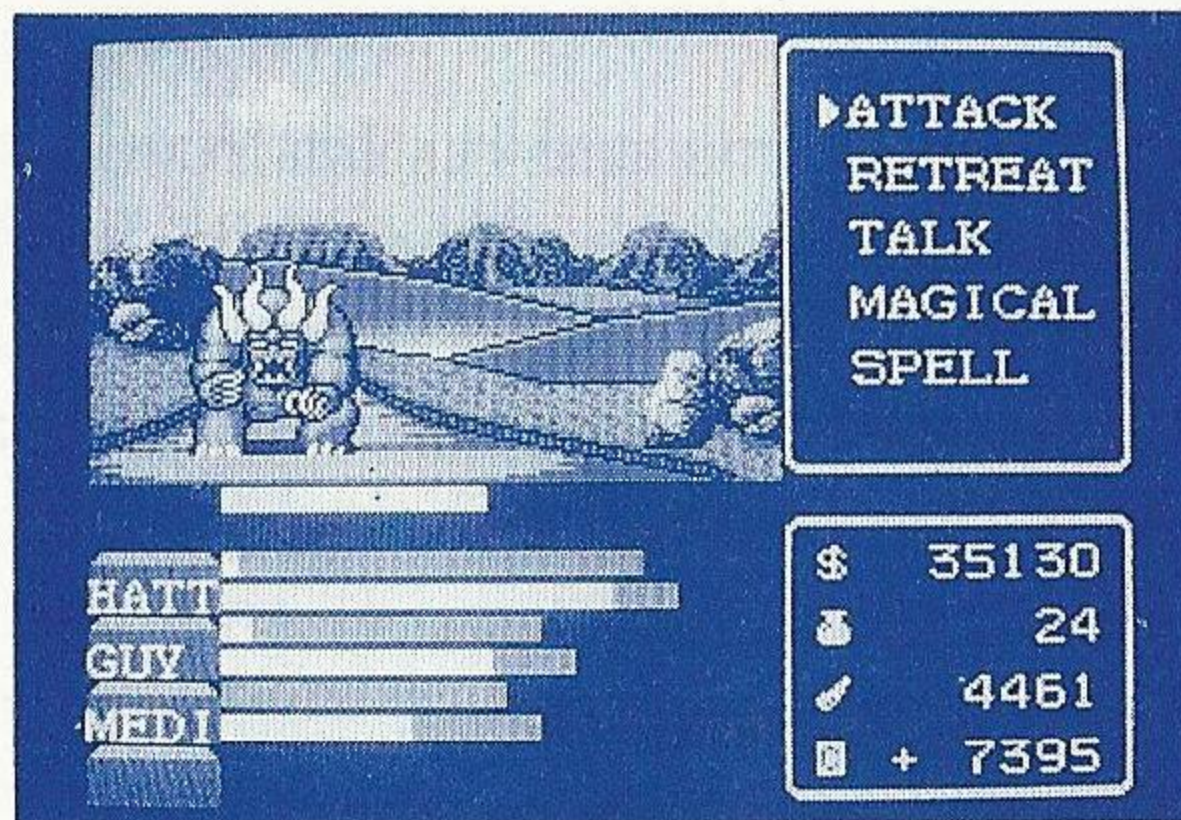

This menu will automatically be displayed when you come in contact with friend or foe. A message will identify what you see. Then you must select an option.

Attack: Use this option to attack. A subscreen will appear in which you must select the member of your party to attack. When in the character selection subscreen, you can use Button 1 to cancel the attack and return to the Encounter menu.

Retreat: This option allows you to escape. Remember that some creatures will trap you, forcing you to fight for your life!

Talk: Use this command to listen to some of the people and creatures you meet in your quest. They could give you valuable hints and knowledge.

Magical: If you have magical items, this option will let you use them. Some magic items don't work against all enemies!

Spell: This option will show you a list of all the spells you have learned. You may choose one and see if it works.

REMEMBER: Iason did not use spells in combat . . . perhaps for a reason!

Villages, Towns and Castles

You will find villages, towns and castles in your travels through the Five Lands. In each you will find or be able to buy weapons, armor, medicine and . . . clues. To enter, place the white square over the village, town or castle and press Button 2. To leave, press Button 1.

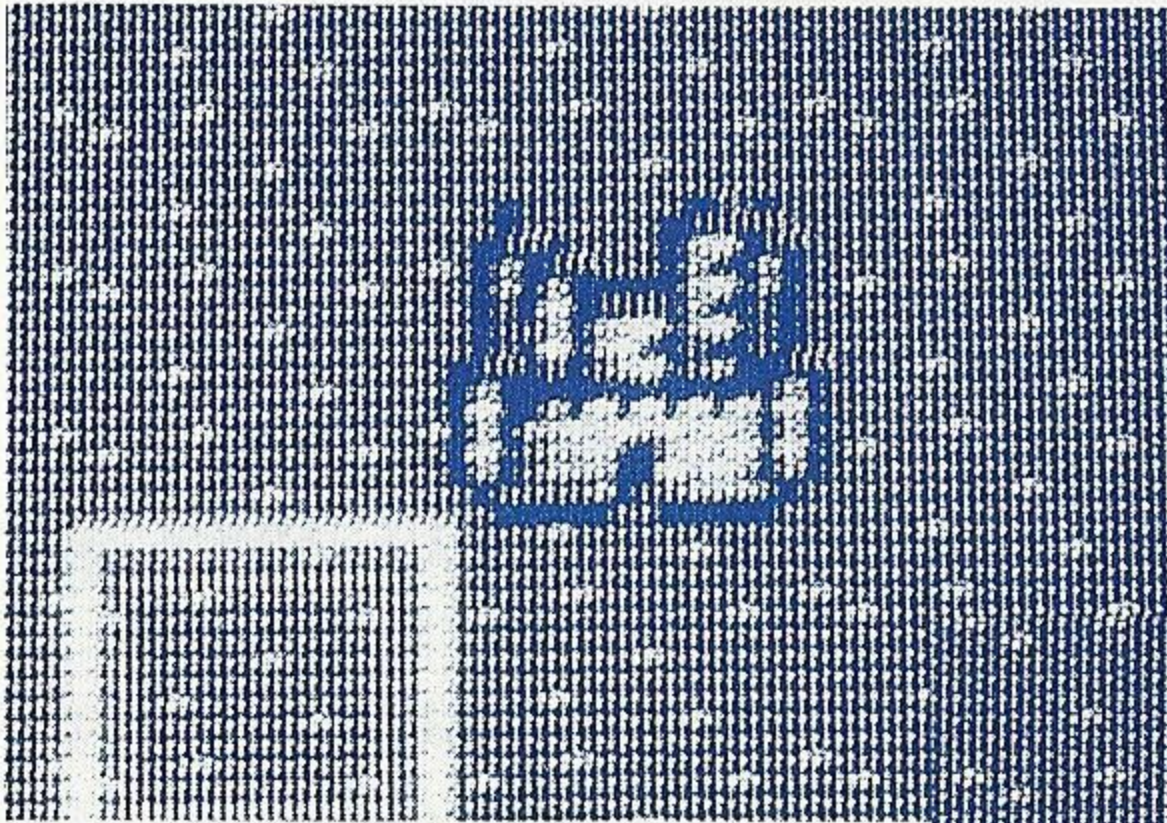

CASTLE

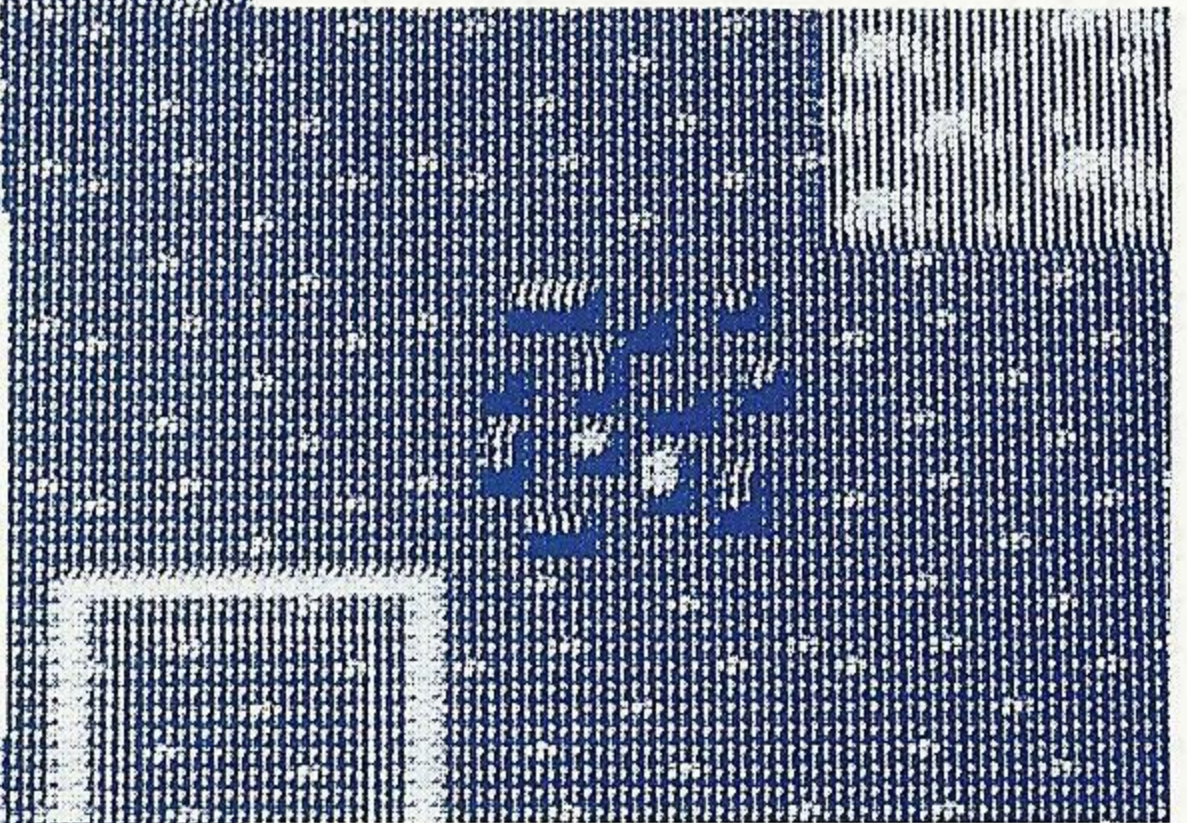

VILLAGE

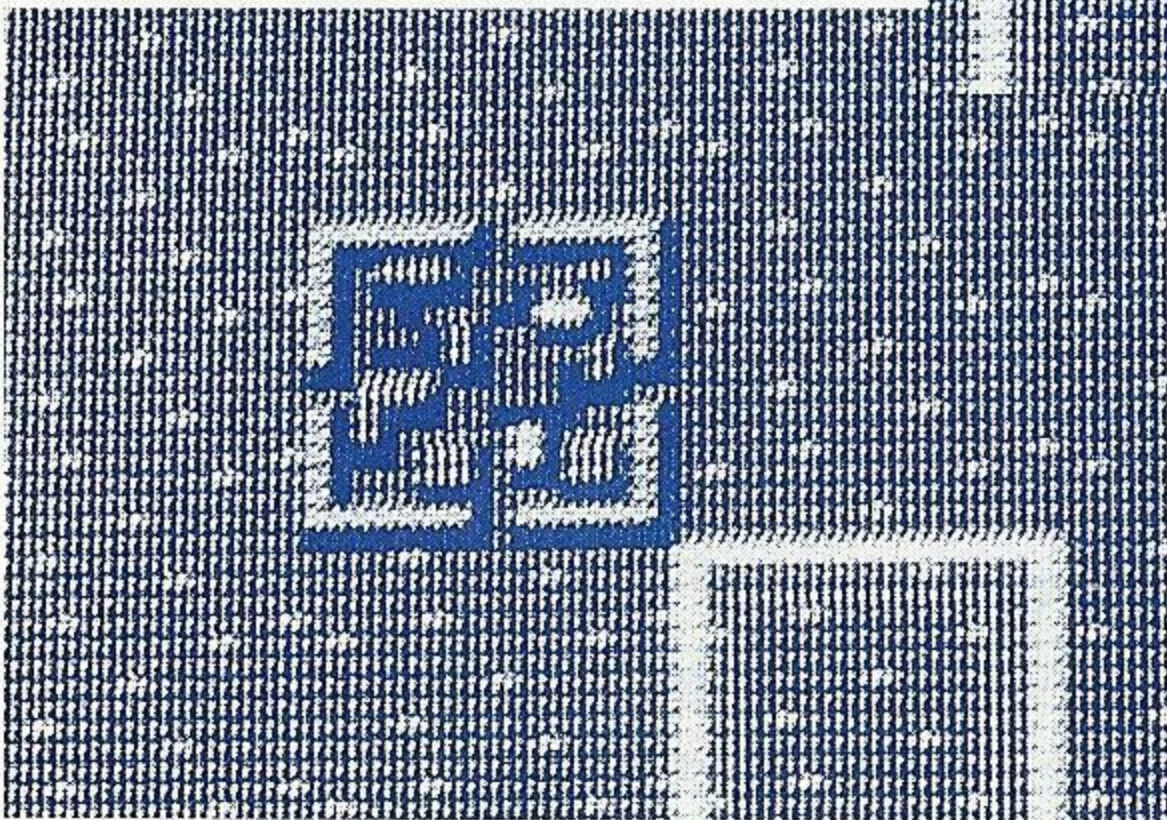

TOWN

Caves, Dungeons and Monuments

You will also find caves, dungeons and monuments to Iason scattered throughout the Five Lands. Some you may enter unhindered. Others will be locked . . . until you find the right person or learn the right spell. But it's best not to venture into cold, black depths until you have a certain magical item or two.

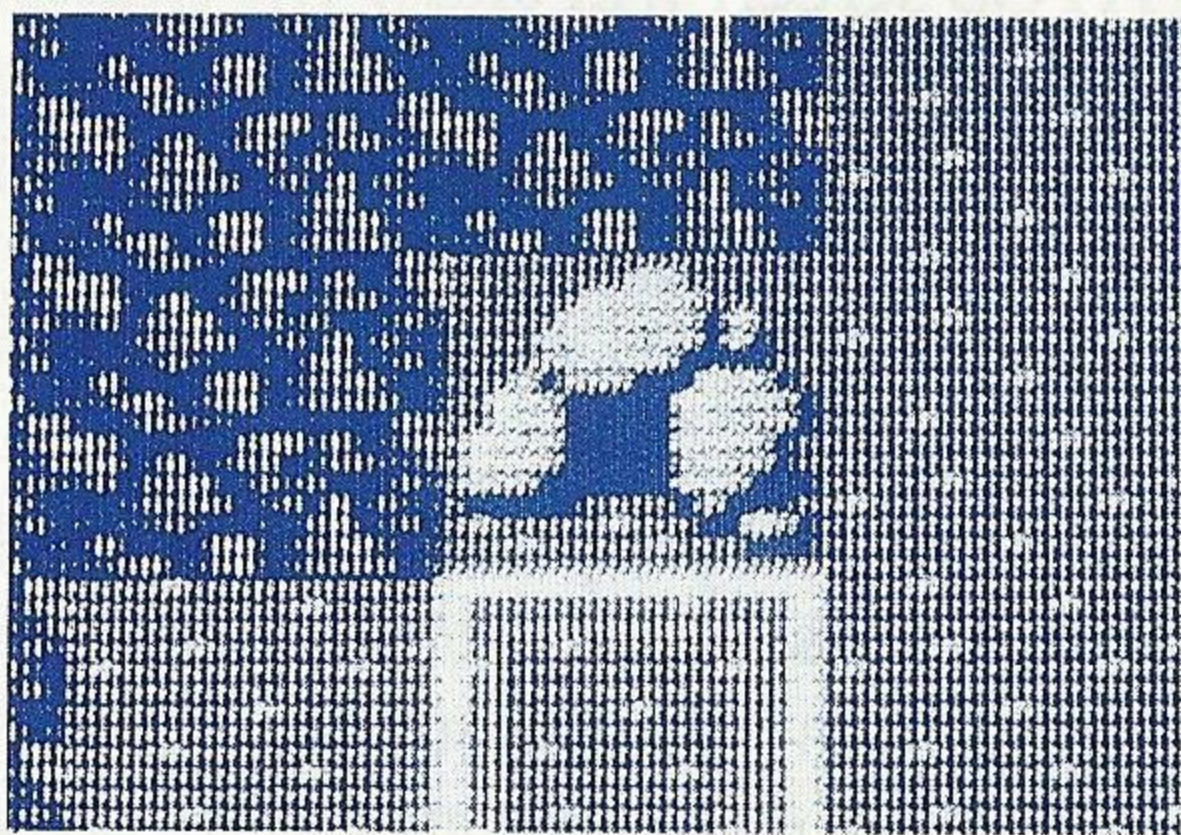

CAVE

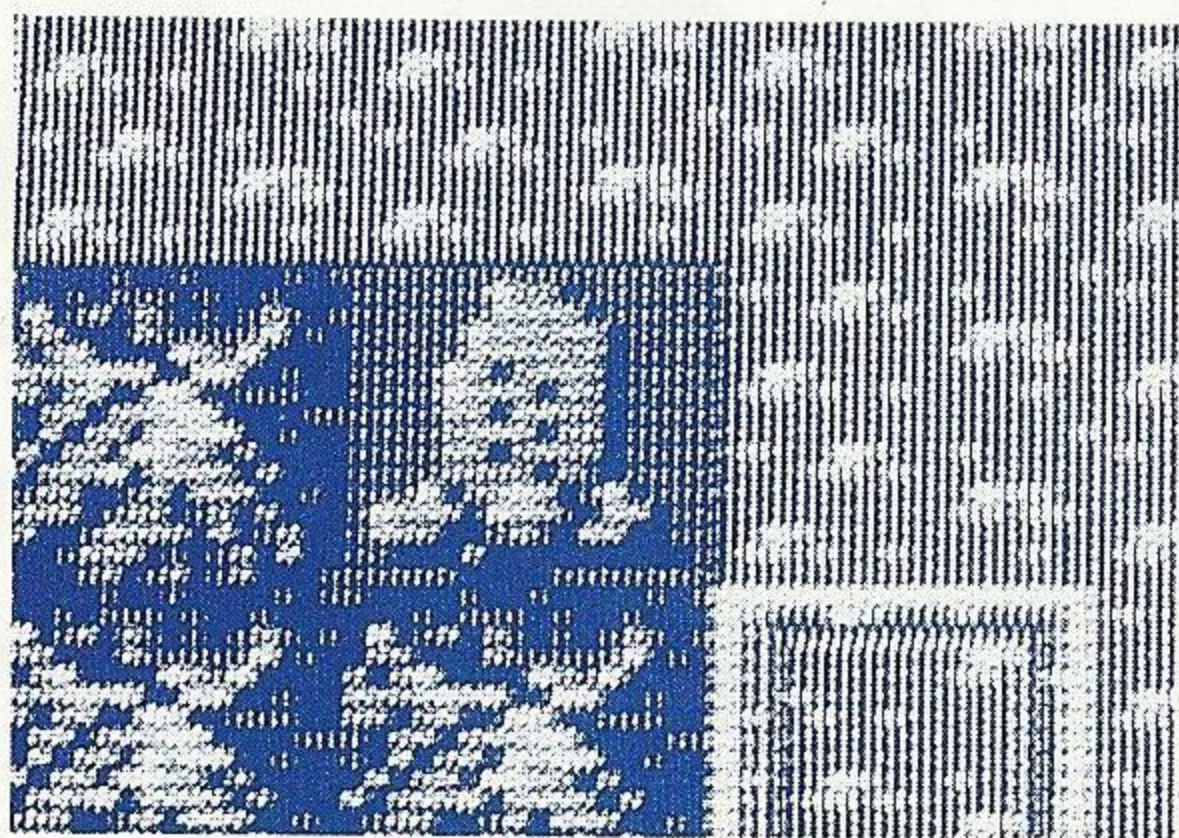

MONUMENT

Arms and Armor

You . . . and your companions as you find them . . . begin your quest empty handed. But arms and armor can be purchased in towns and villages. There you will find knives, swords, shields and suits of armor . . . if you have enough guilders!

Remember that combat takes its toll of your weapons and armor. The STATUS screen will show the number of uses left in your equipment. If it reaches 0, your equipment will break and you will have to purchase more. Swordsmiths can bring new life to your steel for a price! Some may even be convinced to travel with you!

Also, at the time of Iason's prophecy, the white Monks crafted magical weapons and armor for the Miracle Warriors. These were hidden throughout the Five Lands and guarded from the greed of common folk by powerful magic. You must find them to complete your quest.

Friends and Foes

In the course of your journey you will encounter many humans and creatures who will in turn help you or try to harm you. Study each encounter carefully. Defeating evil will help you in every way. But harm the good or innocent and you shall suffer.

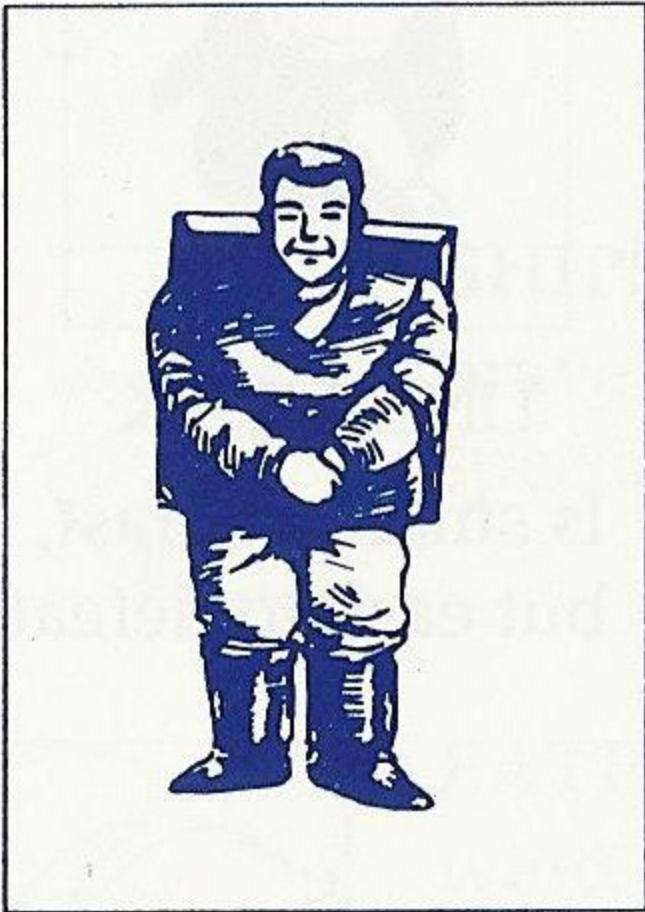

KOSAMA



WHITE MONK

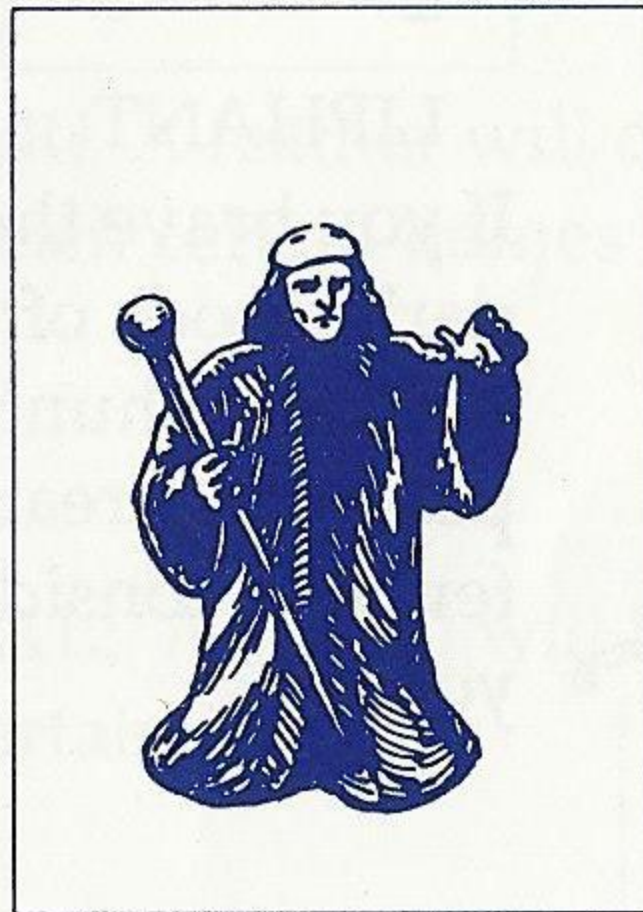

BLACK MONK



TRAVELER

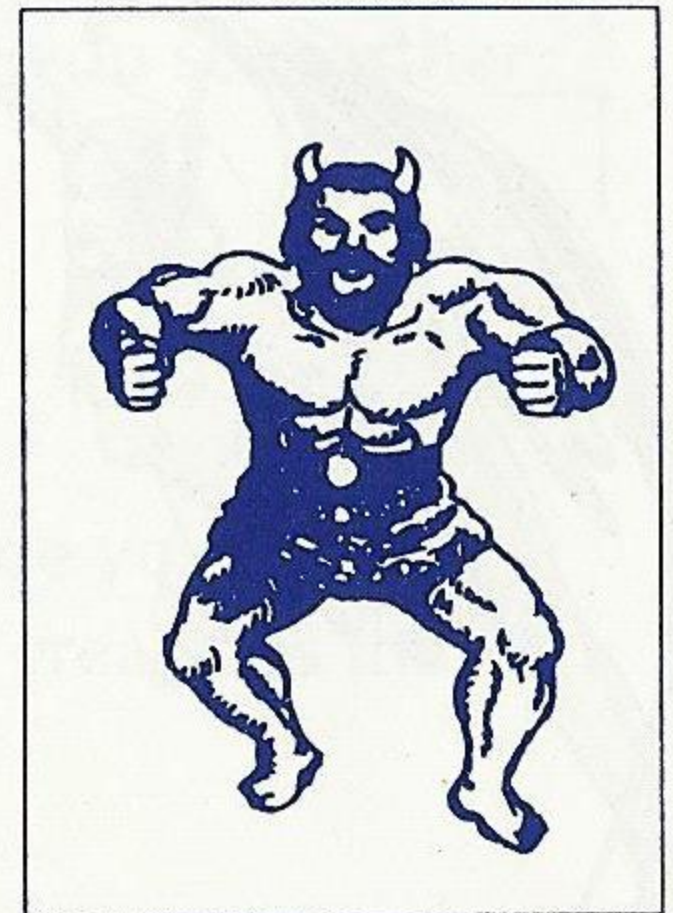

THIEF

Know Thine Enemy

The evil legions of Terarin are too many to count! You will encounter evil creatures of all kinds at every turn, so be on your guard! Knowing these few creatures will help you begin your quest:



EVIL MERCHANT:

He profits from the misfortune of others. Defeat him to get a start in the world.

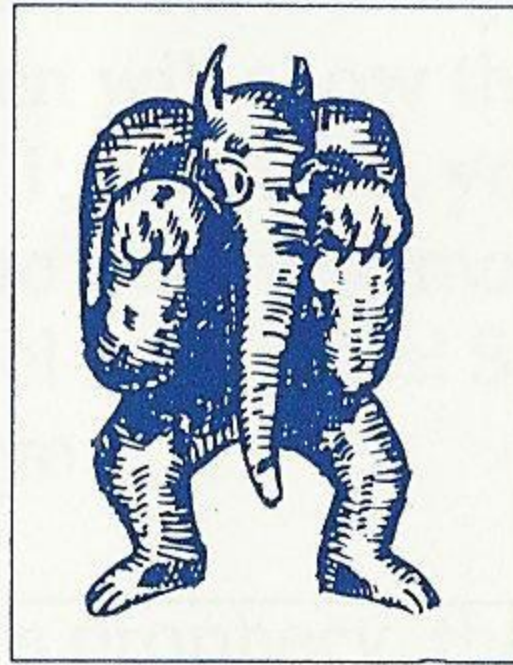

LIPHANT:

If you brave the dark woods of Arukas to hunt this powerful creature, few will consider you nuts.

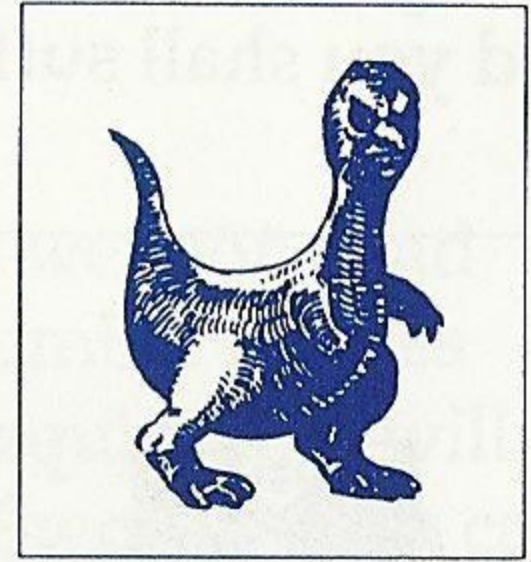

UNMUTAK:

Is small and fast, but easy to defeat.



TERARIN:

The Dark Lord: She is an evil lord from ages past. When you meet her, there can only be one victor!

Special Items

Here are a few of the items you must find to fulfill the prophecy of Iason and defeat Terarin.

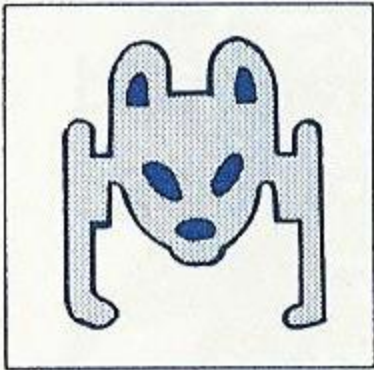

MASK: Wearing a Mask of The Beast will make the caverns less dark.



SHIPS: The only way to cross the seas. To brave the raging storms of Areos, though, a special ship is needed.

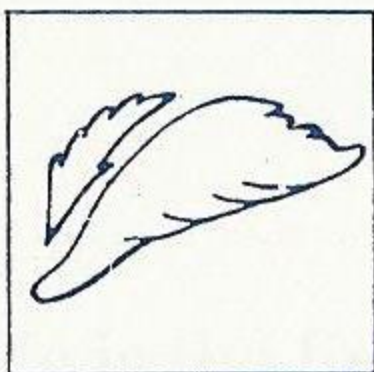

EATHER: A feather will carry you like the wind when certain names are spoken.

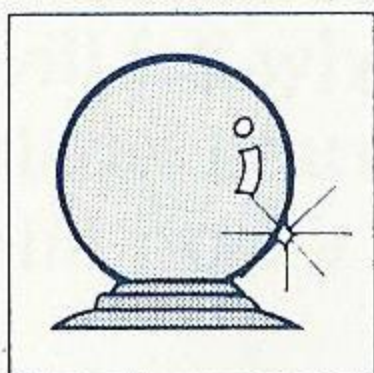

CRYSTAL: A crystal will let you see farther . . . in certain places.

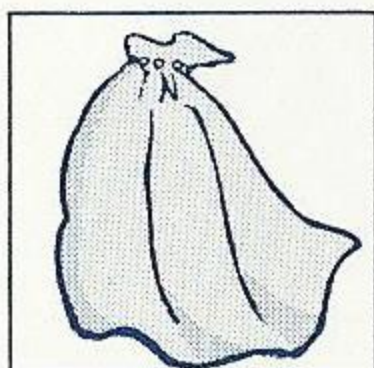

MANTLE: A mantle will hide your aura from weak and insignificant creatures that would hinder your quest.

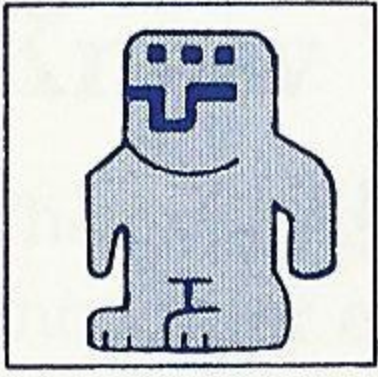

STONE: A Stone Of Protection when used at the right moment can halt an enemy's evil magic.

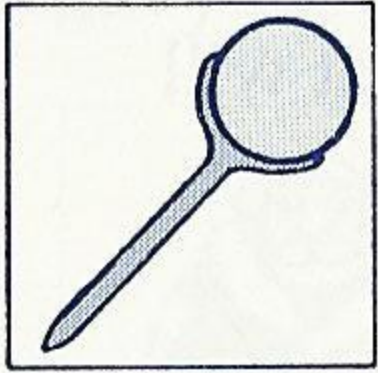

STAFF OF EARTHQUAKES: The Staff of Earthquakes will make the ground crack and tremble beneath your enemies' feet, causing them great damage.

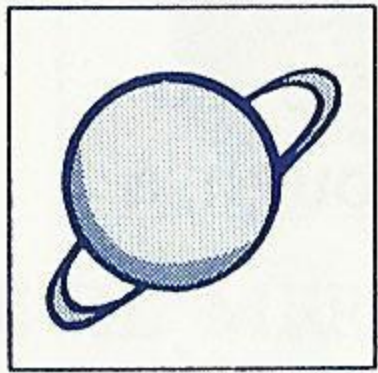

WHITE SPHERE: The White Sphere contains powerful magic to crush your enemies. But you may only carry one sphere at a time . . . and its cost is great!



KEYS: The Key of Heaven
The Key of Earth
The Key of Hell

To reach Terarin and her hiding place, you must obtain all three keys. Only then will you be able to enter the . . . ?

The Miracle Warriors: Thy Companions

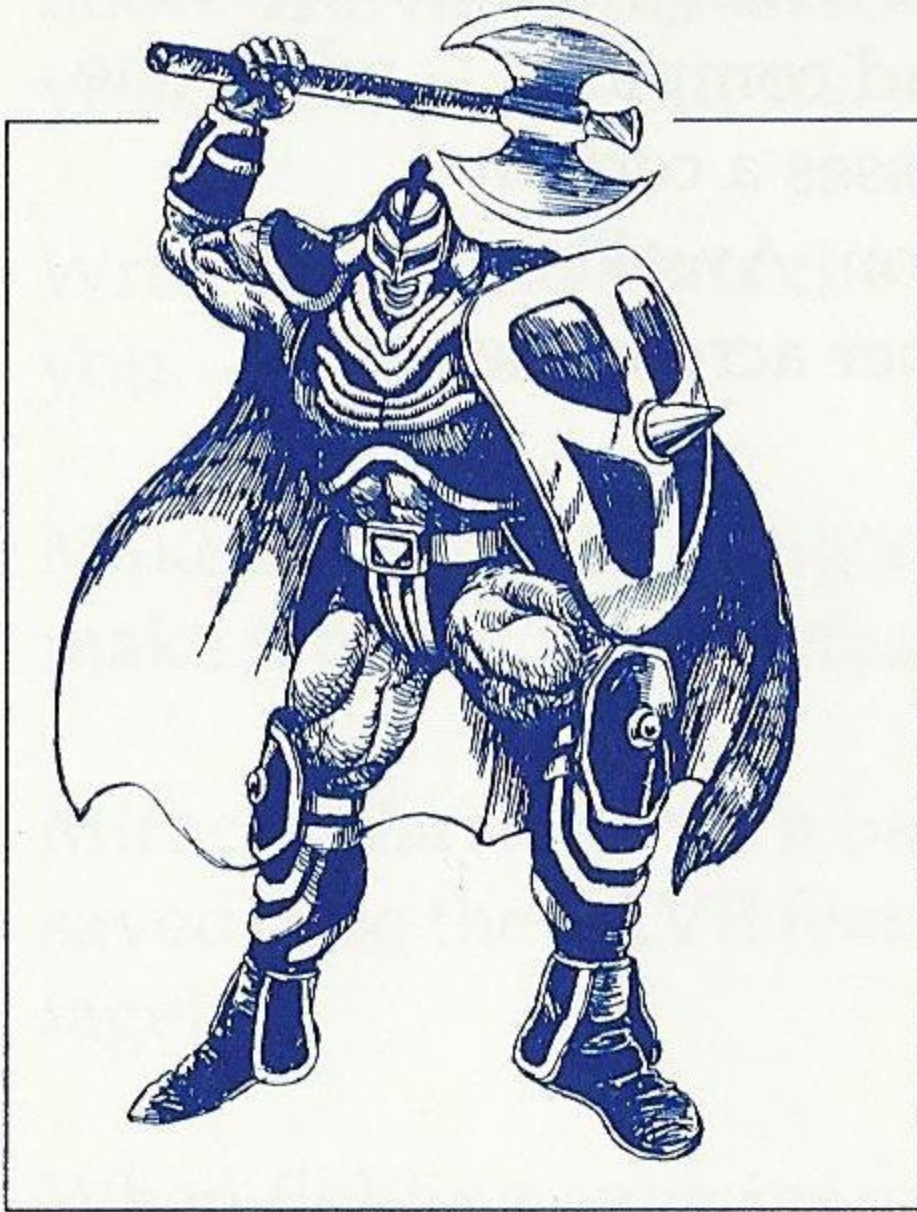

Thou art the leader of this quest. Your vow is to defeat Terarin and use the Golden Seal to close the Pandora Passage . . . as Iason did over a millennium ago.

He is the first of thy companions. A brave and hearty fighter, curses will fail when he wields a special blade. Learn a spell and wake him from a long slumber.

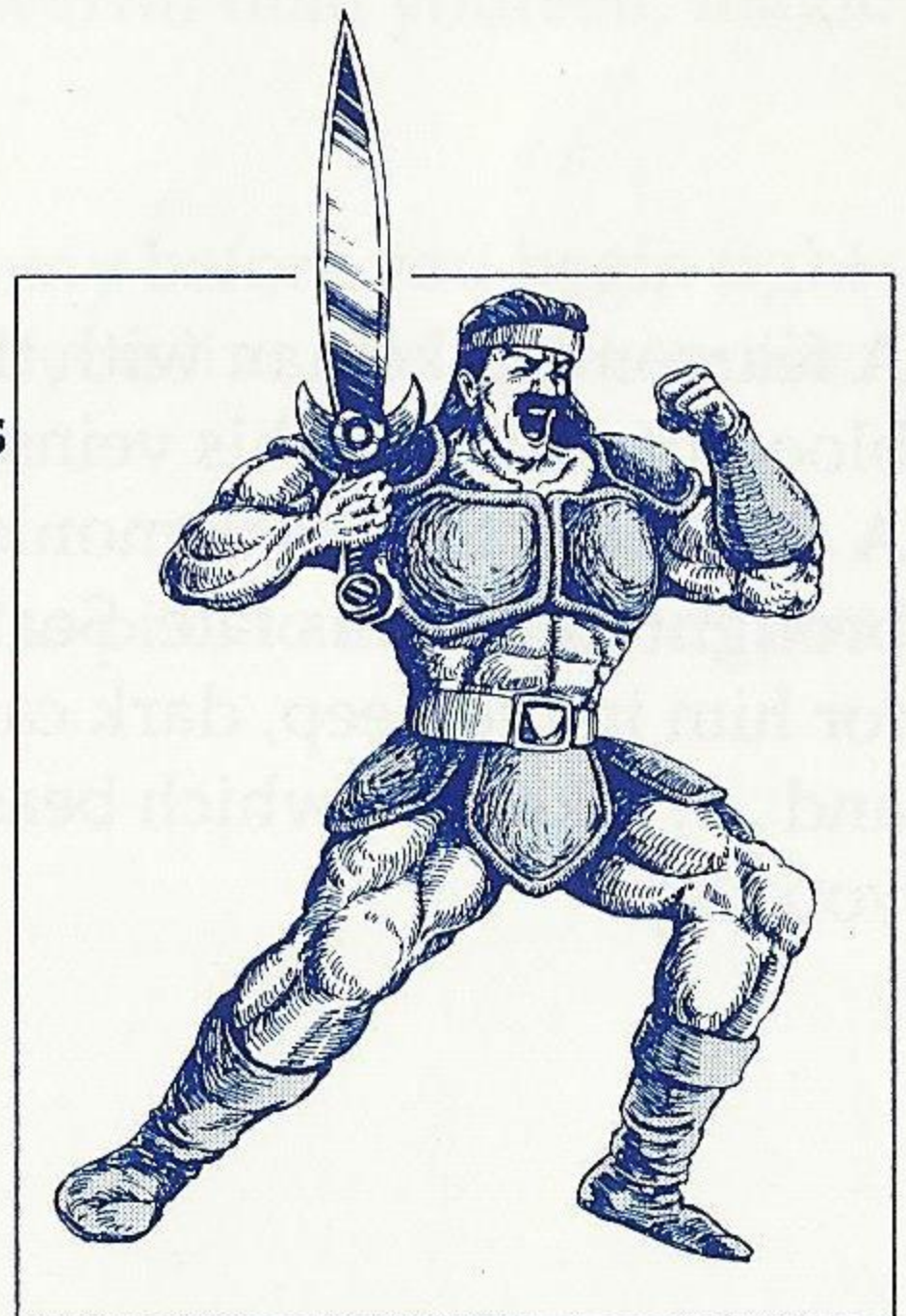

Guy



Medi

The legendary woman warrior. She can spear through the enemy in a CRUSHING AT-TACK with grace and speed beyond compare . . . when she possesses a certain weapon. Awaken her from slumber across the seas.

A fearsome pikeman with the blood of pirates in his veins. A duel with the black monks brought him to his fate. Search for him in the deep, dark caverns and . . . take care which beasts you slay!

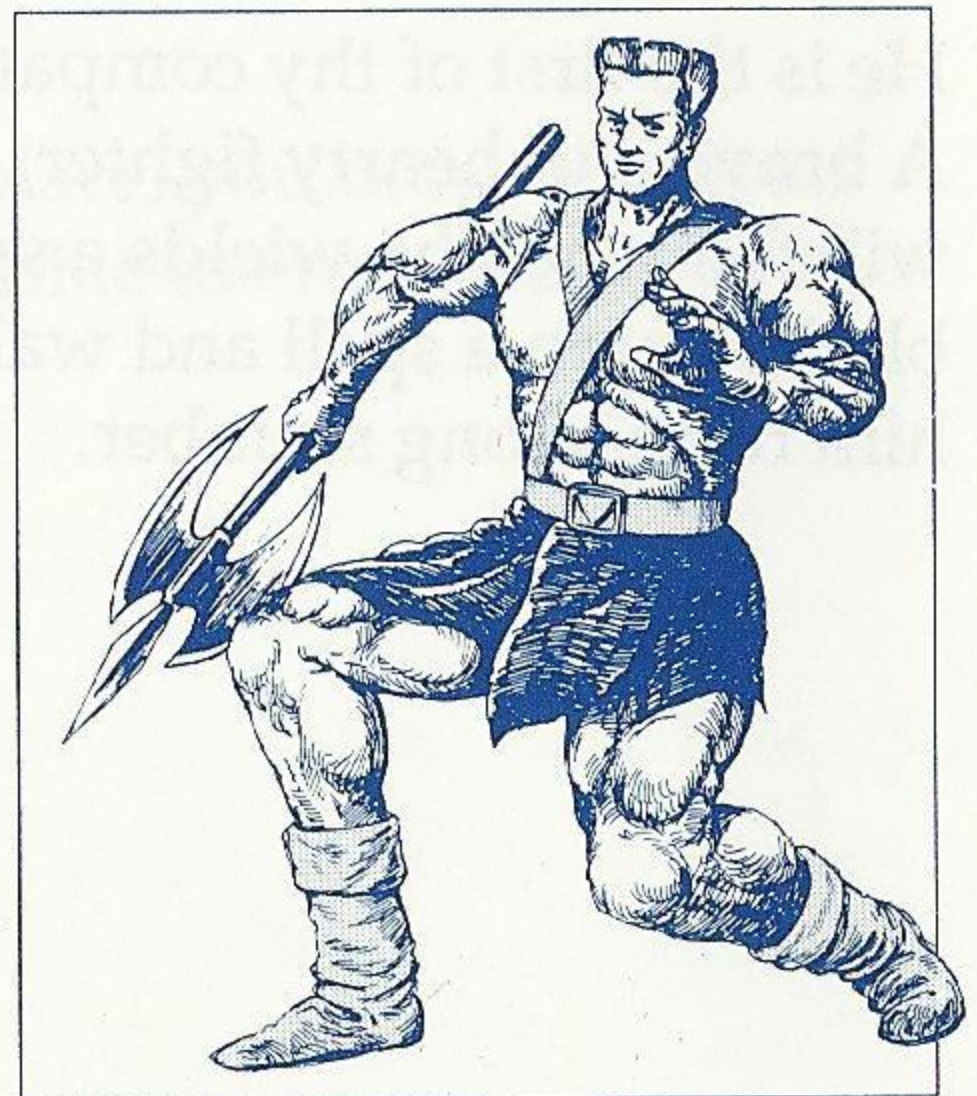

Turo

Helpful Hints

Miracle Warriors™ is not a game you will end in an afternoon. The fun will last for many hours. So don't rush. Take your time, plan your moves and enjoy your quest!

Write down the hints the townspeople and travelers give you.

Make maps of the dungeons you visit. They will help you make it back to the surface!

Miracle Warriors has a battery so up to five games can be saved. Use the SAVE feature often . . . and to your advantage!

When fighting enemies more powerful than yourself, magic items come in handy.

Examine the strength of your enemy before you begin fighting. Sometimes retreating will let you live and fight another day.

Refer to your game map often. Use pins to mark places you find that are not on the map.

Handling The Mega Cartridge™

- The Mega Cartridge is intended exclusively for the Sega System™
- Do not bend, crush or submerge in liquids.
- Do not leave in direct sunlight or near a radiator or other source of heat.

90-Day Limited Warranty Sega® Card/Cartridge

To validate the following 90-day limited warranty, your sales slip or proof of purchase should be retained at time of purchase and presented at time of warranty claim.

90-Day Limited Warranty

Sega of America, Inc. warrants to the original consumer purchaser that this Sega Card™ /Cartridge™ shall be free from defects in material and workmanship for a period of 90 days from the date of purchase. If defect covered by this warranty occurs during this 90-day warranty period, Sega will repair or replace the defective card/cartridge, at its option, free of charge.

This warranty does not apply if the defects have been caused by negligence, accident, unreasonable use, modification, tampering or any other causes not related to defective materials or workmanship.

To receive fast, reliable service, call the Sega Customer Service Department at the following numbers:

Outside California: 800-USA-SEGA

Inside California: 415-742-9300

Our Customer Service Department is in operation from 9:00 AM to 5:00 PM (Pacific Time), Monday through Friday. *Do not return your Sega Card/Cartridge to your retail seller.*

Sega's service center is located at the following address:

Sega of America, Inc.

Warranty Repair

573 Forbes Blvd.

South San Francisco, CA 94080

Limitations On Warranty

Any applicable implied warranties, including warranties of merchantability and fitness for a particular purpose, are hereby limited to ninety days from the date of purchase and are subject to the conditions set forth herein. In no event shall Sega of America, Inc. be liable for consequential or incidental damages resulting from the breach of any express or implied warranties.

The provisions of this warranty are valid in the United States only. Some states do not allow limitations on how long an implied warranty lasts or exclusion of consequential or incidental damages, so the above limitations of exclusion may not apply to you. This warranty provides you with specific legal rights. You may have other rights which vary from state to state.

Sega Customer Service, 573 Forbes Blvd., South San Francisco, CA 94080

(800) U.S.A.-S.E.G.A.

Distributed by Tonka Corp.
Minnetonka, MN 55343

7500 **SEGA**[®]
F R O M T O N K A

MIRACLE WARRIORS;

SEAL OF THE DARK LORD and A TWO-MEGA PLUS CARTRIDGE, are trademarks of Sega Of America, Inc.
SEGA is a trademark of Sega Enterprises, Ltd., a CSK Group Company.

PRINTED IN JAPAN

© 1988 Tonka Corp. All Rights Reserved.