

EA SPORTS
P R E S E N T S

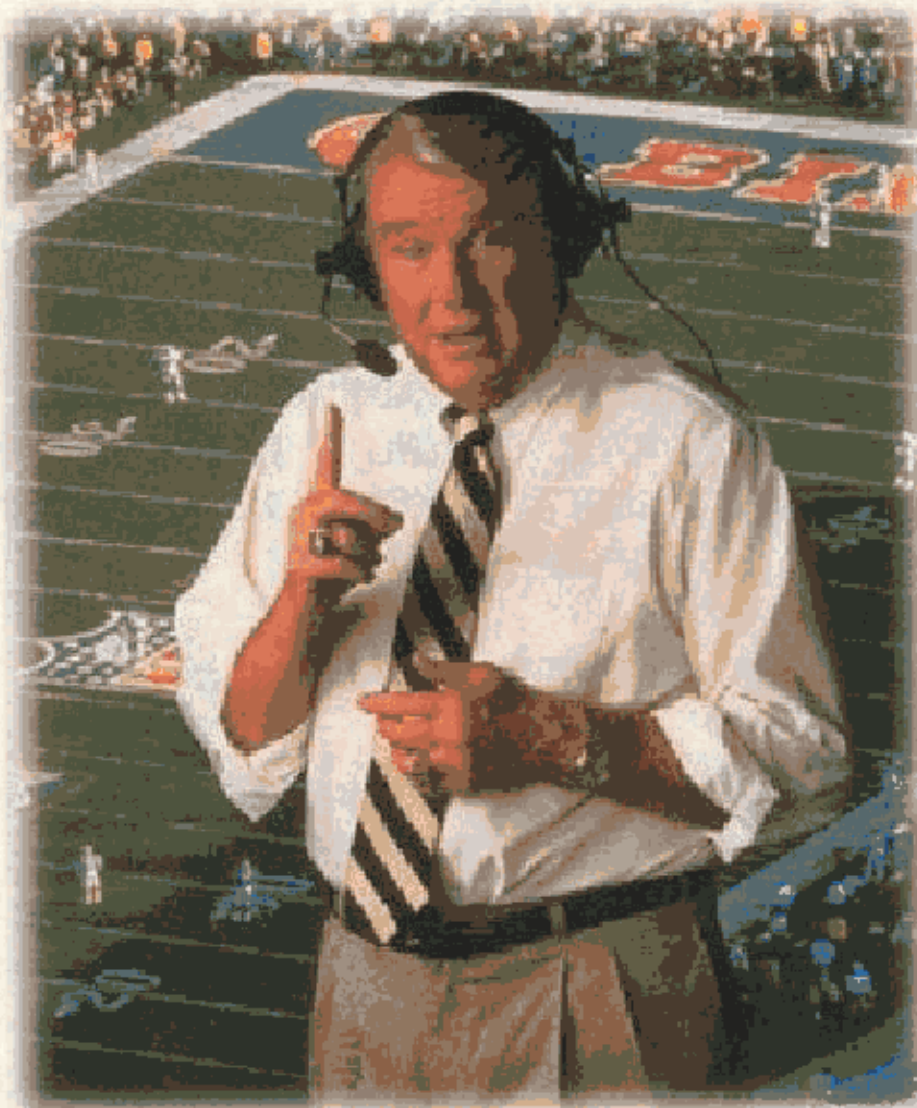

MADDEN



'94





!WARNING To Owners of Projection Televisions!

Still pictures or images may cause permanent picture-tube damage or mark the phosphor of the CRT (television screen). Avoid repeated or extended use of video games on large-screen projection televisions.

**EPILEPSY WARNING
PLEASE READ BEFORE USING YOUR SEGA VIDEO
GAME SYSTEM OR ALLOWING YOUR CHILDREN
TO USE THE SYSTEM**

**WARNING: READ BEFORE USING YOUR SEGA VIDEO
GAME SYSTEM.**

A very small percentage of individuals may experience epileptic seizures when exposed to certain light patterns or flashing lights. Exposure to certain patterns or backgrounds on a television screen or while playing video games may induce an epileptic seizure in these individuals. Certain conditions may induce previously undetected epileptic symptoms even in persons who have no history of prior seizures or epilepsy. If you, or anyone in your family, has an epileptic condition, consult your physician prior to playing. If you experience any of the following symptoms while playing a video game — dizziness, altered vision, eye or muscle twitches, loss of awareness, disorientation, any involuntary movement, or convulsions — **IMMEDIATELY** discontinue use and consult your physician before resuming play.



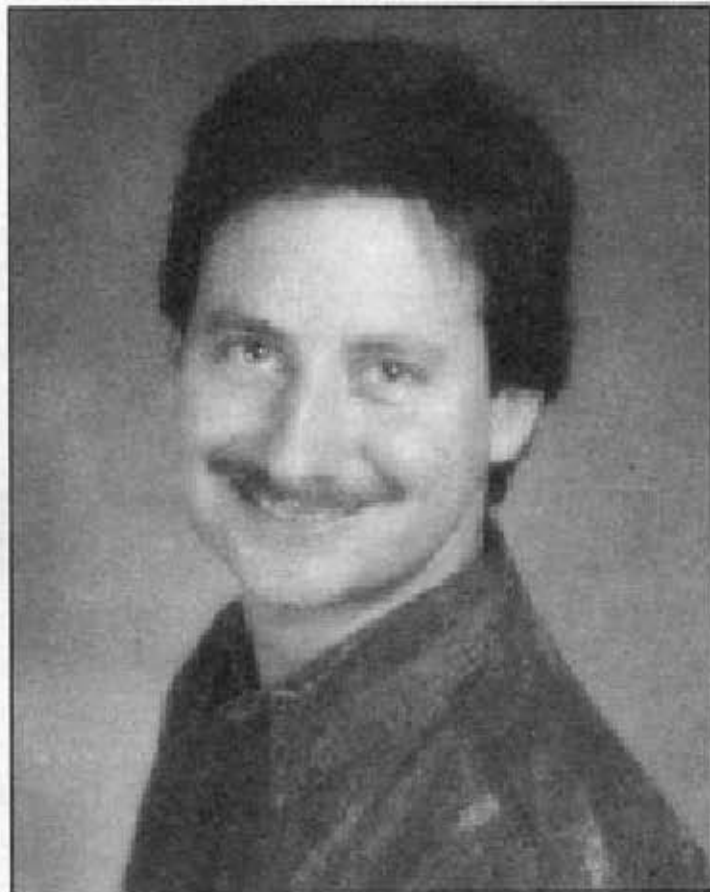

Programmer William Robinson



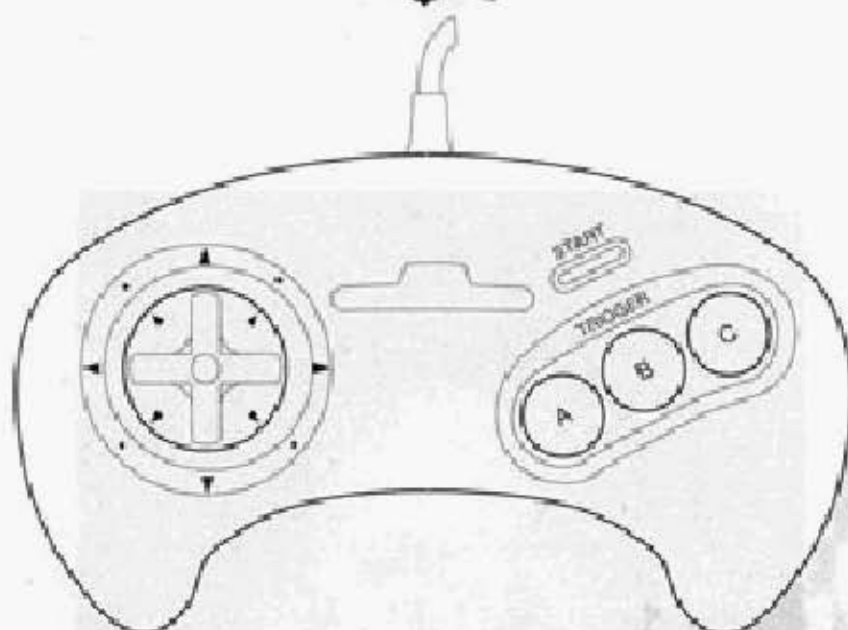

CONTROL SUMMARY

Pausing the Game

- Press **START**

Kicking

- Kick the ball:
 - 1) Press **C** to set the kicker in motion
 - 2) Press **C** when the orange bar reaches the top of the Power Meter to kick the ball. The higher the bar, the farther the kick.
- Aim the ball: D-Pad **LEFT/RIGHT** while the Power Meter is in motion.



- Move the kicking team to onside formation left before the kick: Press
1) **A** to call an audible
2) **A** to shift the players
- Move the kicking team back to its original formation: after you've called an audible: Press **B** to position team

Receiving a Kick

Kick returners automatically field the ball and run unless you move them before or during the kickoff.

- Take control of kick returner: D-Pad **UP/DOWN/LEFT/RIGHT**.

Before the Snap

OFFENSE

- Snap the ball: **C**
- Call fake snap signal: **B**
- Call an audible (a different play at the line of scrimmage):
1) Press **A**. The audible indicator appears on the screen.



2) Press **A**, **B** or **C** to select designated plays. (See *Audibles*.)

- Set a man in motion: D-Pad **LEFT/RIGHT**

NOTE: The ball must be snapped before the 40-second Play Clock reaches zero or the offense will be penalized five yards for delay of game.

DEFENSE

- Control a different player: **B**
- Fire off the line: **C**
- Call an audible:
 - 1) Press **A**. The audible indicator appears on the screen.
 - 2) Press **A**, **B** or **C** to select designated plays (See *Set Audibles* on page 16.)

After the Snap

OFFENSE

Running

- Dive: **A**
- "Umph": (tap) **B**
- Spin: (hold) **B**
- Hurdle: **C**
- Change directions: D-Pad **UP/DOWN/LEFT/RIGHT**



Passing

- Call up Passing Windows: **C**
- Pass to the player in window A: **A**
- Pass to the player in window B: **B**
- Pass to the player in window C: **C**

Hold the button for a bullet pass or tap the button for a lob.

- Drop QB back or scramble: **D-Pad DOWN**

NOTE: When you take control of the quarterback by pressing the D-Pad, you must press C to call up the passing windows.

Receiving

- Dive for the ball: **A**
- Activate the receiver closest to the ball: **B**
- Raise hands to catch the ball: **C**

Punting

- See *Kicking* above

No-Huddle Offense

- Call a play in the no-huddle offense: Hold **C** when the whistle is blown. The play you just ran is called again. (You cannot execute the No-Huddle Offense after an incomplete pass.)



Stop Clock Play

- Run the "QB Stop Clock" play:
 - 1) Hold **A** when the whistle is blown.
 - 2) Press **C** to hike the ball. The quarterback takes the snap and throws the ball into the ground automatically as long as you don't take control of the QB by touching the D-Pad.

DEFENSE

- Dive at the ball carrier: **A**
- Activate the defender closest to the ball: **B**
- Raise hands to block a kick or a pass at the line of scrimmage, or to intercept a pass: **C**

During Instant Replay

- Rewind: (hold) **A**
- Run the tape (slow motion): (hold) **B**
- Run the tape (frame by frame): (tap) **B**
- Run the tape (normal speed): **C**
- Move the cursor that isolates the camera on one player or on one specific point on the field:

D-Pad UP/DOWN/LEFT/RIGHT



TABLE OF CONTENTS

CONTROL SUMMARY	2
WELCOME TO THE NFL	8
FIRE IT UP	8
4-WAY PLAY	9
SETTING UP THE GAME	11
PLAYING A GAME	15
The Scouting Report	15
Team Matchups	16
Set Audibles	16
Play Call Mode	19
Pass Catch Mode	22
Coin Toss/Wind	22
Receiving the Kick	23
Kicking	24
Onside Kick	25
OFFENSIVE COORDINATION	26
Running	26
Passing	27
No Huddle Offense	29
Substitutions	30
DEFENSIVE COORDINATION	31
MULTIPLE PLAYERS-TEAMMATES	32
PAUSING THE GAME	33
Calling A Timeout	33
Game Statistics	34
Instant Replay	35
Set Maddenisms	36
Drive Summary	37
PLAYING A FULL SEASON	38
Viewing Team Schedules	39
Viewing Conference Standings	40
Saving a Season	40
Continuing a Season	41
ENTERING THE PLAYOFFS	41
SAVING THE PLAYOFFS	43
FORMATIONS AND PLAYS	44
TEAMS	52
CREDITS	55



WELCOME TO THE NFL!

Madden NFL '94 features 80 teams, including all 28 1993 NFL teams playing a full 16-game schedule. It also features 12 all-time great franchise teams, 38 Super Bowl teams since 1966 and two "All-Madden" teams. These are the greatest teams ever assembled! If you've ever wondered how the rugged teams of old would match up against the flashy teams of today, *Madden NFL '94* will give you some insight. All we're missing are the grass stains on the uniforms.

FIRE IT UP!

1. Flip OFF the power switch on your Sega™ Genesis™.

WARNING: Never try to insert or remove a cartridge when the power is ON.

2. Make sure a Controller is plugged into Control Port #1 on the Genesis.

If you're playing against a friend, plug the other Controller into Control Port #2.

3. Insert the cartridge into the slot on the Genesis. Press firmly to lock the cartridge in place.



4. Turn ON the power switch.

The EA Sports and High Score logos appear. If you don't see them, begin again at step 1.

5. When Coach Madden's picture appears, press **START** to bring up the *Game Set Up* screen.

4-WAY PLAY™

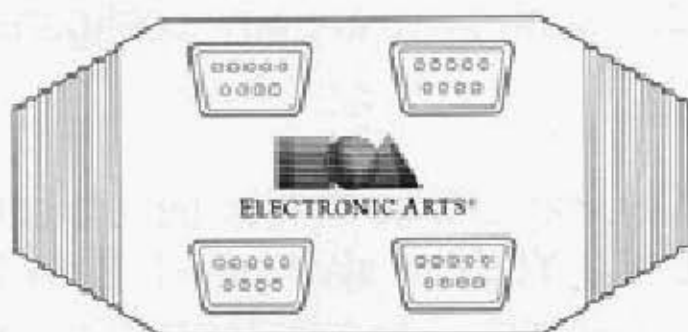

Too many friends, not enough controllers? EA Sports has solved your problem with the all new 4-Way Play four-player controller.

Simply plug the 4-Way Play into your Genesis, then plug up to four controllers into the adapter, and you're ready to go.



NOTE: *Six-button controller users who are using the 4-Way Play must play in three-button mode.*

- To configure your controller to three-button mode:
 - 1) Turn off the Genesis.
 - 2) Hold the "Mode" button on every six-button controller that will be used while you turn the Genesis on.

Your six-button controllers are now configured in three-button mode.

The new 4-Way Play lets up to four people butt heads in *Madden NFL '94*. You can play 3-on-1, 2-on-2, or 4-against-the-Genesis. The adapter features an auto detect device, so all you have to do is plug it into the Genesis and you're ready to go!

When you use the 4-Way Play, the Team Select screen appears with four controllers, each a different color. Just toggle the controllers to the appropriate teams (Remember your color!), then press **START**.

When you're on the field, the following holds true:

- On offense, one person is always the quarterback. He calls the plays, too. Other people can toggle



left/right to take control of any player but the quarterback.

- On defense, the same person who calls the offensive plays calls the defensive plays. Anyone can toggle left/right to take control of any player.
- On both offense and defense, the person who presses **B** first takes control of the player closest to the ball. The person who presses **B** second takes control of the player who is second closest to the ball, and so on.

SETTING UP THE GAME



Use the Game Set Up screen to customize your contest.

- Cycle through options: D-Pad **UP/DOWN**.



- Cycle through choices for the selected option:
D-Pad **LEFT/RIGHT**.

PLAY MODE

(Defaults in **Bold** type)

EXHIBITION: Play against the computer or a friend.
Stats and records don't count.

CONT(INUE) SEASON: Resume a season or tournament in progress at the next scheduled game. (You must have already won a tournament game or have played a regular season game to select this mode.)

NEW SEASON: Play a season from beginning to end. Play one or all of the games and take any team to the Super Bowl.

CONT(INUE) PLAYOFFS: Resume playoffs in progress at the next scheduled playoff game. (You must have already won a playoff game to select this mode.)

NEW PLAYOFFS:

1994 Playoffs: 28 1993 Teams

CHAMPIONSHIP PLAYOFFS: 38 Super Bowl Teams
of the Past

FRANCHISE PLAYOFFS: 12 Franchise Teams

*To learn more about the playoff tournament, turn to
ENTERING THE PLAYOFFS.*



HOME TEAM

Select the team playing for the home crowd.

VISITOR TEAM

Select the visiting team.

Note: When you're playing in a tournament, the computer decides which player is the home team.

GAME LENGTH

20 MINUTES

40 MINUTES

60 MINUTES

WEATHER

The weather can affect a game in an open stadium, but not in a domed stadium. The players tend to have better traction on artificial turf than on natural grass. (This option is available only in an Exhibition game.)

FAIR

RAIN

SNOW

WIND

NIGHT

VARIABLE



The surface on which you play—grass or artificial turf—is the surface of the home team's venue.

When you've set up the game to your liking, press **START**.

The **PLAYER SELECT** screen appears.



- To select a team: D-Pad **LEFT/RIGHT** to move the controller icon (on the screen) under the team helmet of your choice, then press **START** to exit.



PLAYING A GAME

When you exit the PLAYER SELECT screen, The *Pregame Options* screen appears. Here you can exercise several options.

- To select an option: D-Pad **UP/DOWN** to select an option, then press **C**.
- To exit an option menu, press **START**.

THE FOLLOWING ARE OPTIONS YOU CAN EXERCISE FROM THE PREGAME OPTION MENU:

The Scouting Report

Coach Madden delivers the Scouting Report live from the press box before the Pregame Options menu appears. Select *Scouting Report* if you wish to see the report again.

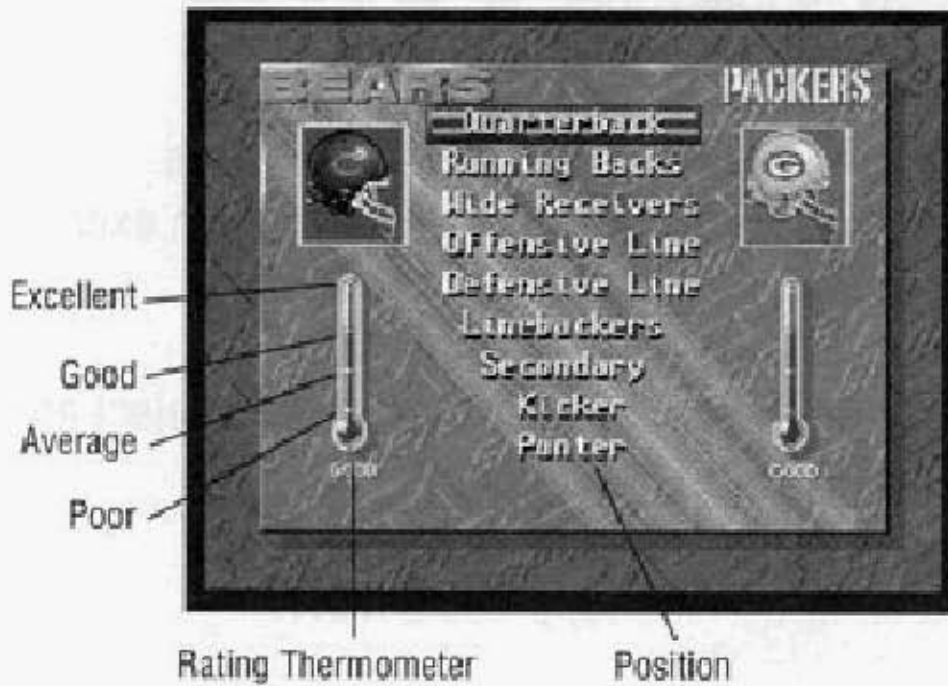

Team Matchups

Here both teams are compared in nine major areas. The higher the red thermometer in a team's rating graph, the more talent the team has in that area.

Set Audibles

An audible changes the play at the line. You can program audibles for all 80 teams. The audibles are saved until you reprogram them. See "To Set Audibles" below.

- To Execute an audible:
 1. Press **A**. The Audible Indicator appears on the screen.



2. Press **A**, **B** or **C** to select an audible.
3. Press **C** to snap the ball. The play begins.

There are three pre-programmed audibles for the offense and three for the defense:

OFFENSIVE AUDIBLES

Hail Mary	Press A
HB Toss Sweep	Press B
Play Action	Press C

DEFENSIVE AUDIBLES

4-3 Monster Blitz	Press A
3-4 Wide Zone	Press B
4-3 Jam Middle	Press C

You can program up to three offensive (and three defensive) audibles at any time between plays or whenever you're at the Pregame or Game Paused screens.

- **To Set Audibles:**

- 1) From the Game Paused screen, D-Pad **UP/DOWN** to highlight SET AUDIBLES, then press **C**.



The SET AUDIBLES screen appears.

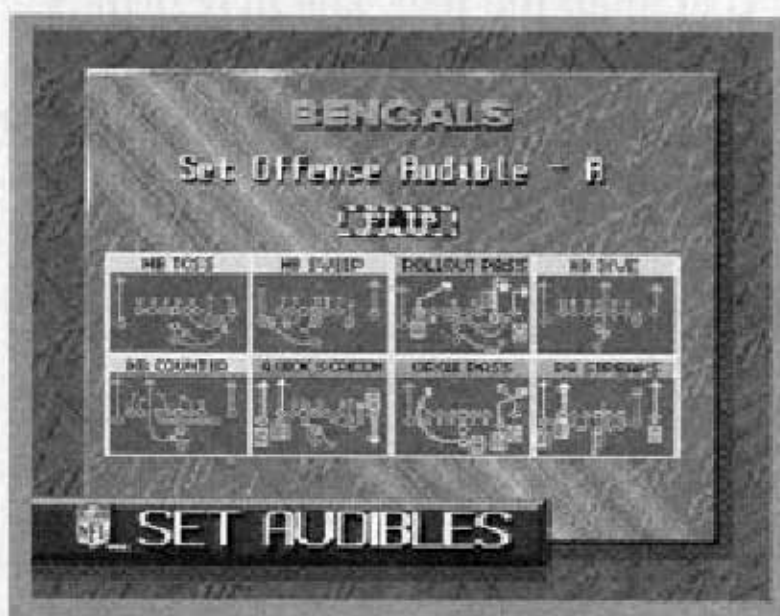

- 2) D-Pad **UP/DOWN** to highlight the letter corresponding to the button of your choice, then press **C** to select.

The FORMATION screen appears.

- 3) D-Pad **UP/DOWN/LEFT/RIGHT** to highlight the formation of your choice, then press the button corresponding to the formation to select.

The PLAY SELECTION screen appears.

- 4) D-Pad **UP/DOWN/RIGHT/LEFT** to highlight the play of your choice, then press the button corresponding to the play.



NOTE: The *Flip* option lets you run any play to the opposite side. To *Flip* a play, (at the *Play Select* screen) D-Pad UP to highlight *Flip*, then press C.

Play Call Mode

Madden NFL '94 features two methods of calling plays: Bluff Mode and Direct Mode.

Bluff Mode is a device which allows you to deceive a human opponent. Direct Mode is a more simple method of selecting plays.

- Select Bluff Mode or Direct Mode from the Pregame screen or the Game Paused screen:
 - 1) D-Pad (**DOWN**) to *Play Call Mode*.
 - 2) Press **C**. The PLAY CALL MODE screen appears.



- 3) D-Pad (**UP/DOWN**) to highlight the option of your choice.
- 4) Press **C**. Your selection is made, and you return to the Game Paused screen.

NOTE: Direct Mode is the default mode.

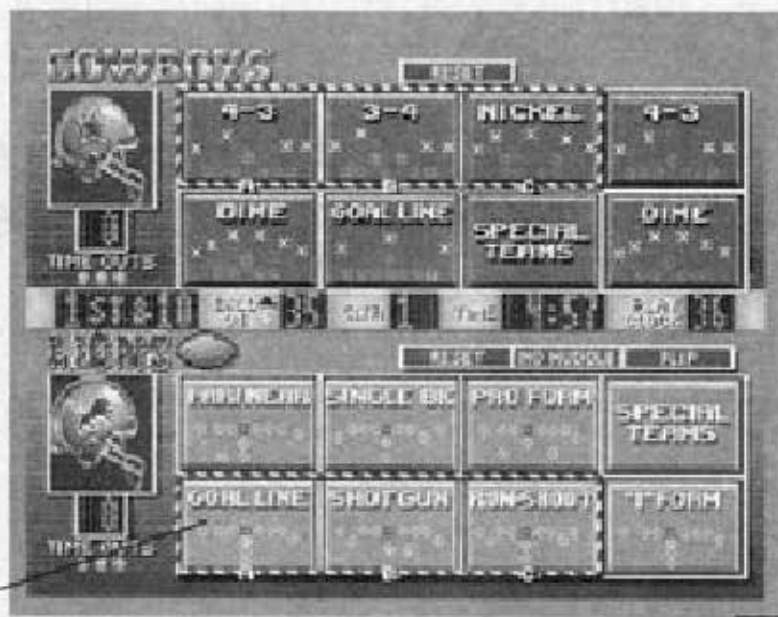

Boxed plays

Direct Mode

- Call a play in Direct Mode: D-Pad (**UP/DOWN**) to box the play you wish to call, then press the button corresponding to that play.

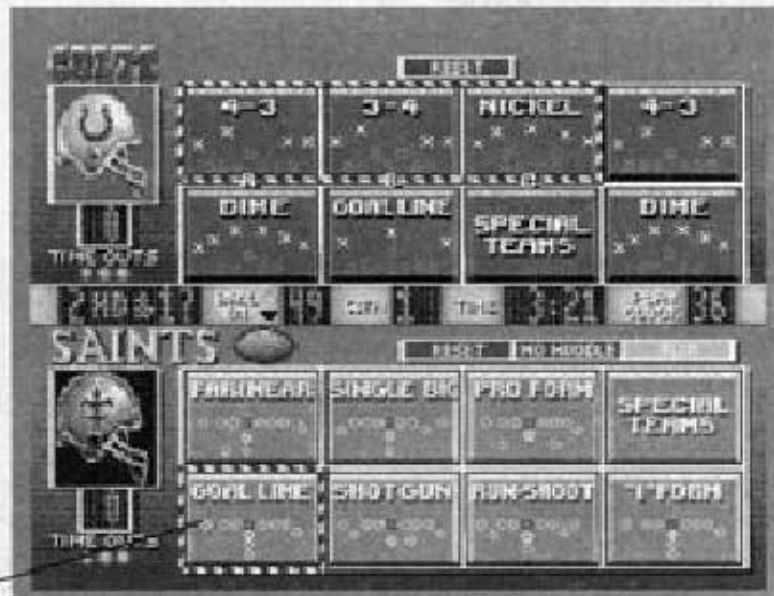

Boxed play

Bluff Mode

- Call a play in Bluff Mode: D-Pad (**UP/DOWN/LEFT/RIGHT**) to box over the play you wish to call, then press **A**.
- Bluff the call: D-Pad (**UP/DOWN/LEFT/RIGHT**) to box over the play you wish to pretend to call, then press **B**.

In other words, **A** breaks the huddle, and **C** actually chooses the play.

When you press **B**, you hear the same “select” sound you hear when you press **C**, but no play is called. In addition, you can choose more than one play with the **C** button; only the last play you choose with the **C** button is run.



Pass Catch Mode

This option allows you to choose who controls your pass receivers.

With Manual Pass Catch Mode, you take control of the designated receiver and control his movement after the quarterback has thrown the ball.

With Auto Catch Mode, the Genesis controls your pass receivers. This mode is the easier of the two pass catch modes.

- **To learn more about passing the ball:** turn to Passing on page 27.

Coin Toss/Wind



Before the referee can start the game, the coin must be tossed. The winner must choose to kick or receive, and



the loser must choose which goal his team will defend in the first half. Press the D-Pad **UP/DOWN** to toggle between **Heads** and **Tails** before the coin hits the ground.



If you lose the toss, you must choose a goal to defend. Press **C** to choose a side to defend.

Receiving the Kick

If you're receiving the kick, your return man automatically catches the ball. If the return man catches the ball in the end zone he will remain in place until you run him out. If you do not run him out, the referee will signal a touchback. If the return man catches the ball in front of the endzone he will automatically move up-field. You can take over any time you wish by pressing the D-Pad.



Press the D-Pad in the direction you want the player with the star to move.

Kicking



The following kicking instructions apply to kickoffs, punts, and field goals.

1. Press **C** to snap the ball and start the Power Meter moving upward.
2. To aim the kick, D-Pad **LEFT/RIGHT** after you press **C**.
3. Press **C** again to stop the meter and strike the ball. The higher the meter is at the time when you stop it, the farther the ball will travel.

Onside Kick

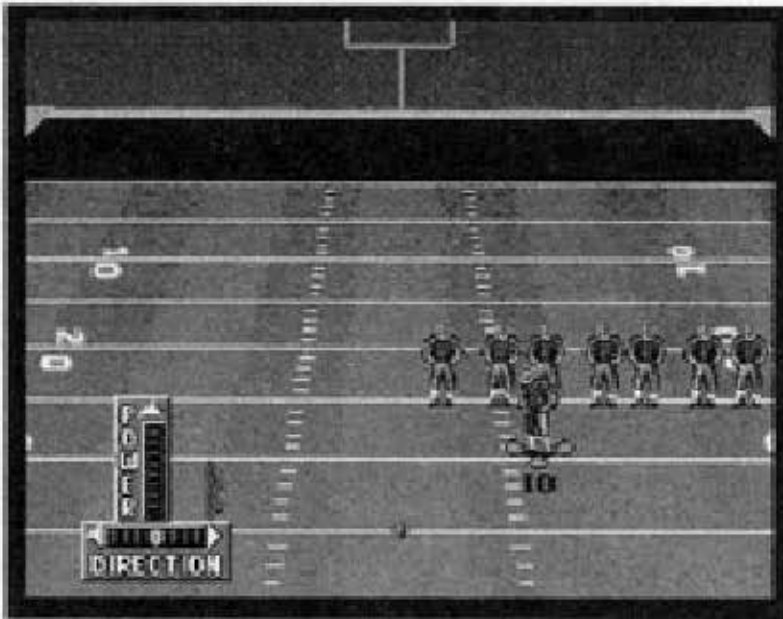

1. Press **A** to call an audible.
2. Press **A** again to set the onside kick formation.

(If you change your mind and want to return to the normal kickoff formation, press **A** and then **B**.)

3. Press **C** to start the Power Meter.
4. Press **C** again immediately while pressing the D-Pad **RIGHT**.



OFFENSIVE COORDINATION

Madden NFL '94 allows you the choice to control a play from the moment the ball is snapped until the referees blow it dead, or to simply call a play and watch it unfold. But before you can call a play, you have to select a set and a formation.

Press the D-Pad **UP/DOWN/RIGHT/LEFT** to toggle through formations, and plays. Press **A, B** or **C** to choose the formation or play in the corresponding box. (See **FORMATIONS AND PLAYS** on page 44 for descriptions of each formation and type of play.)

The **GAME PAUSED** screen appears. Press **START** to return to the action.

HINT: A fake snap might draw the defense offside. Press B.

Running

The handoff on a running play is automatic. You take control after the handoff. The star symbol marks the ball carrier, and his jersey number appears so you know who he is. Use the D-Pad and the action buttons to move the ball carrier through the defense, or watch the computer execute the play you just called.



While your ball carrier is in motion:

- | | |
|--------|-----------------------|
| Dive | Press A |
| "Umph" | (tap) Press B |
| Spin | (hold) Press B |
| Hurdle | Press C |

Passing

There are three receivers for every passing play, represented by the **A**, **B** and **C** buttons. Pass to a receiver by pressing the corresponding button.

Hold the button for a bullet pass; tap it for a lob.

NOTE: You must wait until the passing windows appear before you can choose a receiver. Press **C** if you want to call up the passing windows.

Passing
Windows

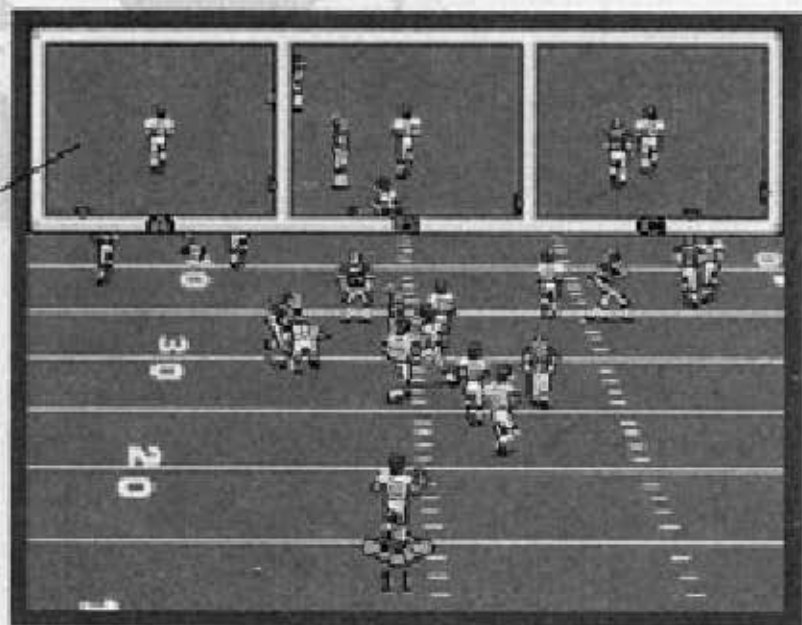

At the line of scrimmage you can send a receiver in motion by pressing the D-Pad **LEFT/RIGHT**.



After you snap the ball, wait for the passing windows to pop up before you press any buttons or the D-Pad. You can let the Genesis execute the play or you can press the button that matches the window of the intended receiver.

TAKING CONTROL OF THE QUARTERBACK

If you move the quarterback out of the pocket or off his designed roll-out by pressing the D-Pad in any direction, the Genesis will no longer execute the play. Then it's up to you to press **C** to bring up the passing windows, choose a receiver, and pass the ball.

Once the ball is in the air, the passing windows disappear. The target spot where the ball is headed appears on the field as a yellow, circled cross.

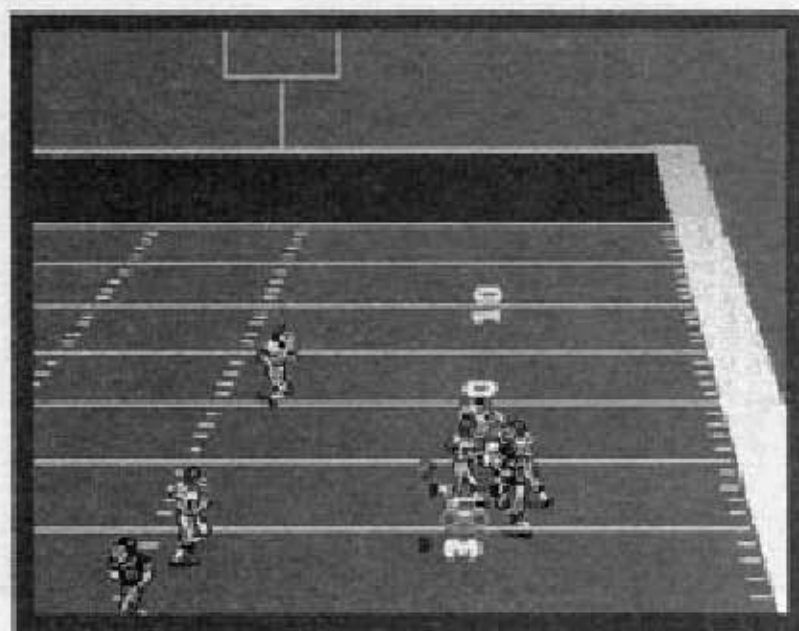



Press **B** to switch control to the intended receiver, then use the D-Pad to guide the receiver to the spot if he's not already there. Also, you can press **C** to raise the receiver's hands. This increases the chance of catching the ball.

- Dive for the ball: Press **A**
- Reach for the ball: Press **C**

No Huddle Offense

When the clock's running down at the end of a half or at the end of a game, most teams don't take the time to huddle. At the end of a play you can go straight to the line of scrimmage in one of two ways:

- Press **C** right after the whistle.

OR

- Select "No Huddle" from the Play Select screen. After the next play, the Play Select screen appears. It shows eight plays, one of which is the play you just ran. (Remember, if an incomplete pass is thrown, the clock stops.)

If you choose to run one of the the plays from the previously run formation, your team returns to the line of scrimmage without a huddle.



If you use the D-Pad to scroll through other plays, your team huddles up and, thus, takes more time off the clock.

You can also run a “Stop Clock” play where the quarterback throws the ball into the ground to stop the clock. This is useful when you’re out of timeouts and you have an extra down to play with.

- Run a “Stop Clock” play: Press **A** immediately after the whistle blows. The quarterback executes a “Stop Clock” on the next play.

SUBSTITUTIONS

When you’re on offense, you can substitute your quarterback and halfback. If your backup signal caller is a better runner than the starting guy, you might want to put in the sub against a team that has given up zero yards passing.

You can only substitute before calling an offensive **FORMATION**.

- To replace your quarterback:
 - 1) Press **START** to pause the game, then press the D-Pad **DOWN** to **SUBSTITUTE QB**.



- 2) Press **C**. Your quarterback is substituted, and you return to the Play Selection screen.

DEFENSIVE COORDINATION

As with the offense, the computer will control the defense if you wish. In fact, you don't even have to call your own formations, sets and plays. If you don't choose a defense, your team runs the defense it ran the previous play. (See page 44 for a description of each set and formation.)

After calling a defensive play, you can select the man you want to control by pressing **B** until the star appears under that player.

The most important command to know on defense, after the ball is snapped, is the **B** button, which switches your control to the defensive player closest to the ball carrier. Move your defender with the D-Pad.

While the play is in progress:

- Dive at ball carrier: **A**
- Activate the defender closest to the ball: **B**
- Jump and raise hands to block a kick or a pass at the line, or to intercept a pass, or to lay a heavy hit: **C**



Multiple Players—Teammates

When playing in the *Teammates* mode, the player with Controller 1 controls the man on the ORANGE star. The player with Controller 2 controls the player on the RED star. On offense, the player with Controller 1 “is” the quarterback and is responsible for calling the plays and snapping the ball.

The player with Controller 2 may use the **B** button to take control of any of the other players on the field. In most cases, the Control 2 player will choose to act as either a running back or a pass receiver, but some people might like to play on the line, as Madden himself once did.

On passing plays, the player with Controller 2 can press **B** to become the intended receiver after the quarterback passes the ball. On running plays, the player with Controller 2 must move the yellow star to the proper running back before the ball is snapped in order to control the ball carrier. Otherwise, Controller 1 automatically controls the ball carrier.

On defense, your team benefits most if you take control of a linebacker or blitzing lineman.



When playing with the 4-Way Play:

<u>Player #</u>	<u>Color of Star</u>
Player 1	Orange
Player 2	Red
Player 3	White
Player 4	Gray

Pausing The Game

You can pause the game at any time. The game clock stops running, and the Pause Menu appears. From this menu you can exercise many of the same options available in the Pregame Options Menu.

- To Pause the game: Press **START**.

Calling A Timeout

Each team is allowed 3 timeouts per half. A player can pause the game at any time and as often as is necessary.

- 1) Press **START** to pause the game.
- 2) D-Pad **DOWN** to CALL TIMEOUT, then press **C**.

The Play Call screen appears, and the playclock is reset to 40 seconds. Notice that one of your team's Timeout indicator lights is now off.



Game Statistics

GAME STATS		
	Steelers	<u>CHARGERS</u>
Score	0	7
Time Of Poss.	0:38	2:01
First Downs	1	3
Passing Yards	0	32
Avg. Yards/Pass	0	8
Longest Pass	0	22
Completions	0/1 (0%)	2/4 (50%)
Rushing Yards	10	47
Avg. Yards/Rush	5	11
Longest Rush	7	46
Total Yards	10	79
3rd Down Con.	1/1 (100%)	1/1 (100%)
	+	

To view the Statistics for a game:

- 1) Press **START** to pause the game.
- 2) D-Pad **DOWN** to Game Stats.
- 3) Press **C**.

Instant Replay

Replay Control

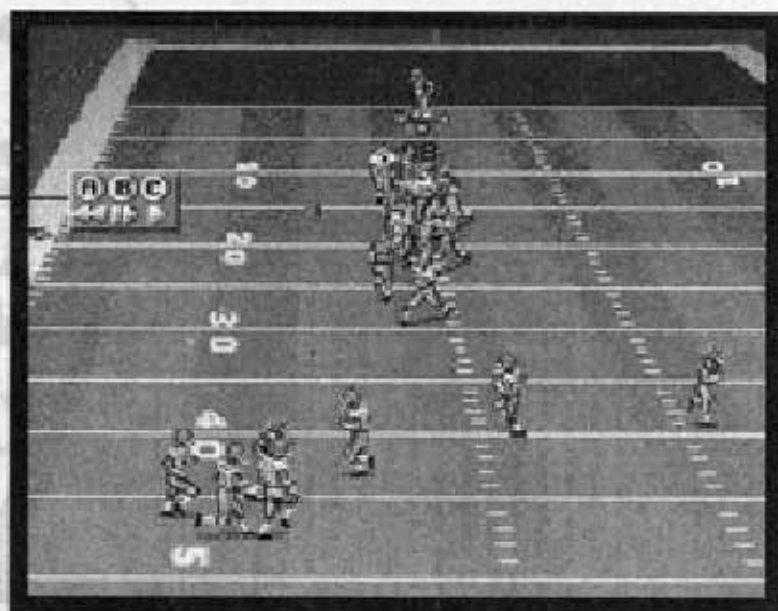

You can view an instant replay after any play.

- 1) Press **START** to pause the game.
- 2) D-Pad **DOWN** to highlight *Replay-Normal* or *Replay-Reverse*, then press **C**.
- 3) Follow the VCR-like control instructions in the left corner of the screen to operate the replay camera.

Hold **A**: Rewind

Tap **B** repeatedly: Replay Frame by Frame

Hold **B**: Replay in Slow Motion

Hold **C**: Replay at Normal Speed

If you wish to isolate a particular player or a particular portion of the field, use the D-Pad to position the orange circle cross over the player or portion of the field you want to isolate, then follow the above instructions.



Set Maddenisms

You can play the game with John Madden's searing commentary, or you can play it and call it on your own.

- Turn Maddenisms on or off from the Game Paused screen:
 - 1) D-Pad (**DOWN**) to *Set Maddenisms*.
 - 2) Press **C**. The Maddenism Selection screen appears.

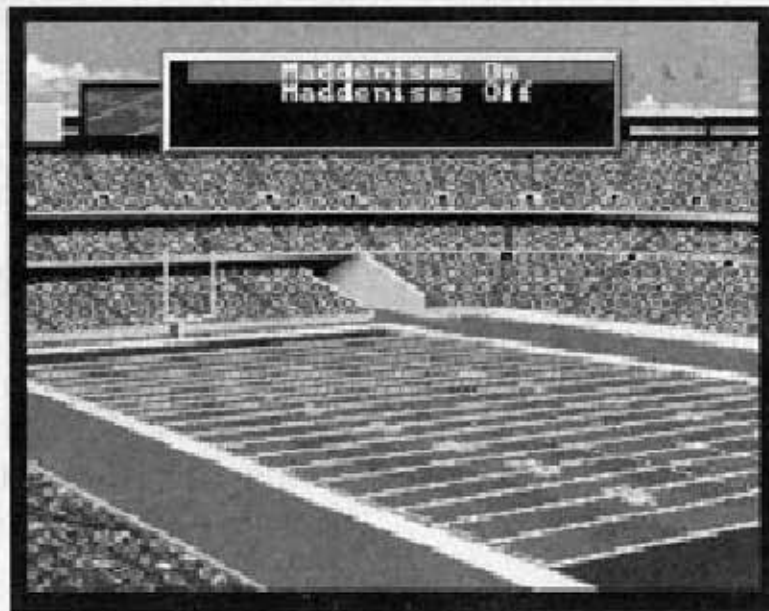

- 3) D-Pad (**UP/DOWN**) to highlight the option of your choice.
- 4) Press **C**. Your selection is made, and you return to the Game Paused screen.

NOTE: Maddenisms On is the default mode.



Drive Summary

The Drive Summary displays the offensive plays run on the current drive. It shows the type of play (pass or rush), the yards gained or lost, and any penalties that have been called.

- 1) Press **START** to pause the game.
- 2) D-Pad **DOWN** to *Drive Summary*.
- 3) Press any button.

The Drive Summary screen appears.

The screenshot shows the 'DRIVE SUMMARY' screen with a table of play statistics. The table has columns for 'Plays', 'Yards', and 'Time of Possession'. The rows are categorized by 'Rushing', 'Passing', 'Penalties', and 'Total'. Below the table, there are additional statistics for 'Rush' and 'Pass'.

	Plays	Yards	Time of Possession
Rushing	1	1	
Passing	7	71	1:33
Penalties	1	-5	
Total	9	67	1:33

	10	20	30	40	50	60	70	80	90	100
Pass	0	0	0	0	0	0	0	0	0	0
Pass	0	0	0	0	0	0	0	0	0	0
Pass	35	45								
Rush				5						
Rush				4						
Pass				15						

- 4) Press **START** to return to the previous screen.

NOTE: If you don't see every play you ran during a drive, D-Pad (UP/DOWN/LEFT/RIGHT) to scroll through the entire drive summary.



PLAYING A FULL SEASON

Now for the first time you can play a full 16-game NFL season with all 28 NFL teams. You can even play every game in the entire season and playoffs. Each week simply select the game or games you want to play, then go at 'em one at a time. Madden NFL '94 keeps a close eye on all season games and provides you with up-to-the-minute league standings.

- To Play a Season Game: From the GAME SETUP screen, D-Pad **RIGHT** to select NEW SEASON, then press **START**.

The NFL Schedule for Week #1 appears.

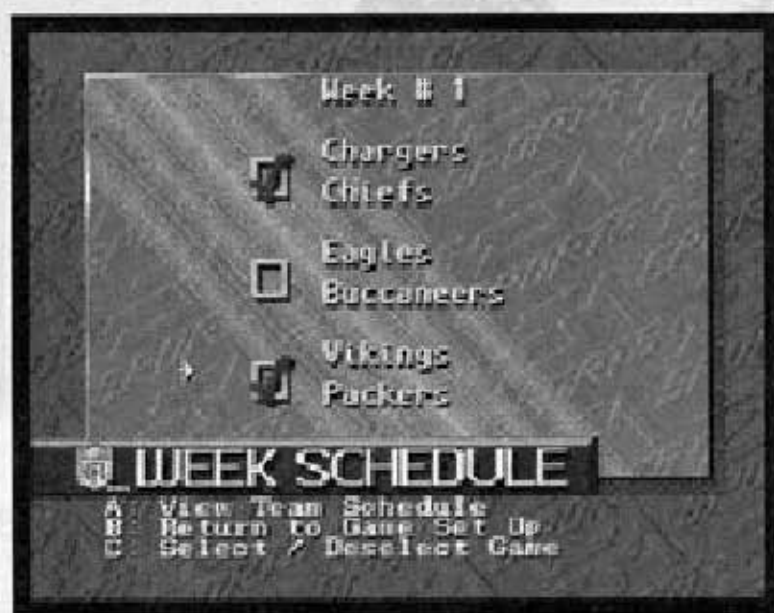

This screen shows each matchup for the first week of the season. D-Pad **DOWN** to view the entire schedule.



- To View the next week's schedule: D-Pad **RIGHT**. D-Pad **RIGHT** again to view the weekly schedules for the entire season.
- To Play a game: D-Pad **UP/DOWN** to highlight the matchup of your choice, then press **C**.

A check mark appears in the box beside the matchups you choose. If, after selecting a matchup, you decide you don't want to play, press **C** again and the check mark disappears.

You can play as many of Week #1's games as you want.

When you have selected the game(s) you want to play (or if you decide to let the Genesis play all of the games for you), press **START**.

The **PLAYER SELECT** screen appears. Choose teams now.

The **SCOUTING REPORT** appears. You play a season game the same way you play an exhibition game.

Viewing Team Schedules

From the NFL Week Schedule screen you can check out your team's schedule and the current standings for each conference.



- To View a team's schedule: D-Pad **UP/DOWN** to highlight the matchup which contains the team whose schedule you want to view, then press **A**.

The Team Schedule for the *top* team appears.

- To view the other team's schedule: Press **C**.
- To generate a new schedule: Press **A**.
- To return to the NFL Week Schedule screen, press **B**.

Viewing Conference Standings

- To view Conference Standings: From the Game Set Up screen, select LEAGUE STANDINGS, then press **C**.
- To view other Divisions: D-Pad **UP/DOWN**.

Saving a Season

NOTE: Only one playoff or season can be saved at a time. If you save a new playoff or season, the previously saved playoff or season is erased.

- To save a season:
 - 1) Complete your current season game.
 - 2) Return to the Game Set Up screen.Your season is saved for play at a later time.



Continuing a Season

- To Continue a Season: Proceed to the Game Set Up screen and select *Cont. Season* next to the *Play Mode* option, then press **START**.

ENTERING THE PLAYOFFS

Madden NFL '94 features three types of playoffs: the New Playoffs, featuring the 1993 teams; Championship Playoffs, featuring the best teams ever, and Franchise Playoffs, featuring the best franchise teams (players who played on the same team in different eras). All three types of playoffs work the same way.

- To Enter the Playoffs: From the GAME SET UP screen, D-Pad **LEFT/RIGHT** to highlight New Playoffs, Champ. Playoffs or Franchise Playoffs; then press **START**.

The **FIRST ROUND** screen appears.

- To Select a matchup:
 - 1) D-Pad **UP/DOWN** to highlight the matchup of your choice.
 - 2) Press **C** to mark the game or games you want to play.



A red check mark appears in the box beside the matchup. If, after selecting a matchup, you decide you don't want to play, press **C** again and the check mark disappears.

You can play as many First Round Playoff games as you want. If you don't want to play any games, press **START**. The Genesis generates the outcomes of each game and presents the scores. You can then play one or more games from the Week #2 schedule, or you can press **START** to simulate the week's action.

When you're ready to move on, Press **START**. The **TEAM SELECT** screen appears.

- To Select a team, D-Pad **LEFT/RIGHT** to move the Control Pad Icon under the team of your choice, then press **START**.





The Tournament Tree appears. D-Pad **LEFT/RIGHT** to scroll through the entire tree. Press **START** when you're ready to go to the Pregame show.

Play a **Playoff** game as you would play a **Season** game.

AFTER A PLAYOFF GAME

After a playoff game, the **DIVISIONAL PLAYOFFS** screen appears. Select your game(s) as before, then press **START** to advance to the **Team Select** screen.

SAVING THE PLAYOFFS

NOTE: Only one playoff or season can be saved at a time. If you save a new playoff or season, the previously saved playoff or season is erased.

- To save a playoff:
 - 1) Complete your current playoff game.
 - 2) Return to the **Game Set Up** screen. Failure to return to this screen following your playoff game may have unexpected results. Your season is saved for play at a later time.

- To restore a playoff: Select **Cont. Playoffs** from the **Game Set Up** screen.



Formations And Plays

NOTE: The "Flip" button on the playcall window lets you change the direction of any play. When you Flip, each play is run in the opposite direction. In other words, if you flip a sweep to the right, it becomes a sweep to the left.

- To Flip the plays in the playcall window:
 - 1) D-Pad **UP** to highlight FLIP.
 - 2) Press **C**. Now select the play as you would otherwise.

Below is a list of the available formations.

SHOTGUN

This is primarily a passing formation because the quarterback receives the snap about five yards behind the line. He gets a deeper drop, which means more time to throw the ball.

RUN & SHOOT

This formation has four quick receivers and a halfback. Guys with good hands who run forty yards in less than five seconds are the stuff defensive backs have nightmares about.



PRO-FORM

This is a version of the pro-set, where a fullback and a halfback line up beside one another and behind the quarterback.

FAR and NEAR

These terms simply describe where the halfback lines up. He's either *far from* or *near to* the strong side of the offensive line. (That's the side where the tight end lines up.)

I FORMATION

Two backs line up directly behind the quarterback. A great formation from which to run dives, sweeps and screens.

SINGLE BACK

Two tight ends and one halfback make this a good rushing formation.



OFFENSIVE PLAYS

FLOOD

One of the most effective ways for a quarterback to beat zone coverage is to flood, or overload the zone with multiple receivers. A defender has to think twice about leaving his own zone to follow a receiver into another guy's zone.

CUT

You've heard of turning on a dime. That's sportswriter talk. I never really understood why you'd want to do that, even if it was possible. I guess it means turning fast. I think cutting is a more accurate description of the ability to change direction. A guy's going one way and boom, he cuts and is going another way.

PULL

In a pull play the guard runs parallel to the line of scrimmage and turns up field when he clears the tight end. The running back follows right behind, a smile on his face.

TRAP

Like all good offensive plays, the Trap depends on deception to work. The idea is you "trap" a defensive guy into thinking one thing is happening, when really something totally different is going on. For example, you



let a defensive end just walk into the backfield. You put up only token resistance. He's saying "Man, this is a piece of cake, I'm going to stuff this play and maybe get a sack." Suddenly an earth mover disguised as an offensive guard comes from an unexpected direction and the defensive guy is on his backside wondering what happened. The runner jets through the area where the defensive guy was, when he was standing up.

COUNTER

A Counter play relies on misdirection. You try to sell the defense on the idea that the play is going right, for example, when in fact you want to go left. It's a tough sell. You send everybody but the water boy and the guy who's going to carry the ball in one direction. When you have them moving the "wrong" way, give the ball to the running back and he runs to daylight in the opposite direction.

SCREEN

A screen is a short pass caught behind the line of scrimmage. Usually the quarterback lures rushing defenders toward him and then loops a soft pass over their outstretched hands to a moving running back/receiver who follows a screen of blockers downfield.



PLAYACTION

Playaction (also called play fake) refers to a pass thrown after the quarterback has faked a handoff to a running back. The back tries to add to the deception by pretending to take the ball and follow blockers. The idea is that the fake delays the pass rushers, and makes the defensive backs run toward the line to help tackle the guy they think has the ball.

DRAW

The opposite of a play action pass. The QB drops back as if to pass and hands off to the running back who charges up the middle of the formation. By the time the rushing defenders realize the deception, their momentum may have taken them beyond the ball carrier.

QUICKOUTS

Sometimes called a square out. In this pass pattern the receiver takes a few steps upfield and makes a quick 90 degree cut to the nearest sideline. If he doesn't want to sit next to the water cooler for the rest of the game, he tries to stay in bounds.

CROSS

Most crossing patterns are the opposite of quickouts—the receiver turns toward the middle of the field. Some guys call them slants, but it just depends on the angle that the receiver runs.



POST UP

Post patterns are for fast guys. The receiver runs downfield and angles in toward the goal post. If the quarterback can really air out the ball, and the receiver can run like the wind, this bomb can score.

STOP CLOCK

Here the quarterback simply spikes the ball into the ground.

OFFENSIVE ALIGNMENTS

The formations show how your offensive team lines up when you call certain plays (see OFFENSE, above). Remember: Not all plays are compatible with every formation. We're showing you the most common ones here. You'll be more competitive if you use these alignments in combination with the PLAYER RATINGS found on the enclosed poster. Here's an example of how they work.

From the PLAYER RATINGS you can find out who your fastest wide receiver is. You can find out where that guy lines up by looking at the OFFENSIVE ALIGNMENT chart. You might want to call a play for him from the passing windows, if his hands are as good as his feet.



DEFENSIVE PLAYS

DEFENSIVE FORMATIONS

GOAL LINE

A good line up for stuffing the short run and goal line defense.

3-4

Featuring three down linemen with four linebackers, this defense is now the most popular in professional football. Used for short and medium zone pass coverage and containment against the run.

4-3

Standard four down linemen (two tackles and two ends) with three linebackers. It's most effective against short passes and the run.

NICKEL

Gets its name from the addition of a fifth defensive back (nickel back). When a pass is expected, many teams add a defensive back to their sets, and take out a linebacker. Cover and Read sets are available.

DIME

When the defense is willing to mortgage the farm that the next play is going to be a pass, they might put in a sixth defensive back. This is the Dime defense or Dime package. Cover and Read sets are available.



DEFENSIVE ALIGNMENTS

The alignments show how your defensive team lines up when you call certain formations. You'll be more competitive if you use these alignments in combination with the **PLAYER RATINGS** on the enclosed poster. Here's an example of how to use them.

From the **PLAYER RATINGS** you can find out who your fastest defensive back is. From the **DEFENSIVE ALIGNMENT** chart, you know where that guy lines up. If he's not covering the man or zone you want him to cover, get control of him by pressing **B** (until he's standing on the star symbol) and then use the **D-Pad** to move him into the position where you think he'll do the most good.



TEAMS

1993 TEAMS

AFC East

New York Jets
Miami Dolphins
Indianapolis Colts
Buffalo Bills
New England Patriots

AFC Central

Pittsburgh Steelers
Houston Oilers
Cleveland Browns
Cincinnati Bengals

AFC West

Seattle Seahawks
Los Angeles Raiders
Kansas City Chiefs
San Diego Chargers
Denver Broncos

NFC East

Washington Redskins
New York Giants
Philadelphia Eagles
Dallas Cowboys
Phoenix Cardinals

NFC Central

Minnesota Vikings
Green Bay Packers
Detroit Lions
Tampa Bay Buccaneers
Chicago Bears

NFC West

New Orleans Saints
Los Angeles Rams
San Francisco 49ers
Atlanta Falcons



THE 1993 ALL-MADDEN TEAM

1 ALL-TIME ALL-MADDEN TEAM

SUPER BOWL TEAMS SINCE 1966

Kansas City 66

Oakland 67

Baltimore 68

Kansas City 69

Dallas 71

Miami 72

Pittsburgh 75

Oakland 76

Denver 77

Pittsburgh 78

Philadelphia 80

San Francisco 81

Washington 82

San Francisco 84

New England 85

New York 86

Denver 87

San Francisco 89

Buffalo 90

Green Bay 66

New York 68

Minnesota 69

Baltimore 70

Washington 72

Minnesota 73

Dallas 75

Minnesota 76

Dallas 77

Los Angeles 79

Oakland 80

Cincinnati 81

Los Angeles 83

Miami 84

Chicago 85

Washington 87

Cincinnati 88

New York 90

Washington 91



ALL-TIME FRANCHISE TEAMS SINCE 1950

AFC

Dolphins

Raiders

Colts

Chiefs

Browns

Steelers

NFC

Cowboys

Giants

Redskins

Packers

49ers

Bears



CREDITS

Design: **Michael Kosaka & Happy Keller**

Strategy by **John Madden**

Programming: **William Robinson**

Graphics: **Curt Toumanian & George Simmons**

Music & Sound Effects: **Jim Simmons & Joel Simmons**

Executive Producer: **Scott Orr**

Associate Producer: **Happy Keller**

Assistant Producer: **Michael Rubinelli**

Technical Director: **Rob Harris**

Product Testing: **Kevin Hogan, Jordan Maynard,**

Gordon Bellamy, Steve Imes, John Vilandre, Greg

Kawamura, Mike Caldwell,

Daniel Breiz & Kenny Rogers

Scouting Reports: **Mike Madden, Joe Madden**

Player Ratings: **James Bailey, Michael Rubinelli &**

Gordon Bellamy

Product Manager: **Bill Romer**

Package Design: **E.J. Sarraille Design Group**

Documentation: **J. Poolos, T.S. Flanagan, R.J. Berg**

Package Photography: **Henrik Kam**

Documentation Layout: **Jennie Maruyama, Laurie Lau**

Quality Assurance: **Rich Rogers, Paul "Bluebeard"**

Armatta

Special Thanks: **John Schappert, Visual Concepts,**

Sandy Montag, Bill Romer, Gene Goldberg & Randy

Delucchi



ELECTRONIC ARTS LIMITED WARRANTY

Electronic Arts warrants to the original purchaser of this Electronic Arts software product that the medium on which this computer program is recorded is free from defects in materials and workmanship for a period of ninety (90) days from the date of purchase. This Electronic Arts software program is sold "as is," without express or implied warranty of any kind, and Electronic Arts is not liable for any losses or damages of any kind resulting from use of this program. Electronic Arts agrees for a period of ninety (90) days to either repair or replace, at its option, free of charge, any Electronic Arts software product, postage paid, with proof of purchase, at the Electronic Arts Warranty Department. This warranty is not applicable to normal wear and tear. This warranty shall not be applicable and shall be void if the defect in the Electronic Arts software product has arisen through abuse, unreasonable use, mistreatment or neglect.

LIMITATIONS - THIS WARRANTY IS IN LIEU OF ALL OTHER WARRANTIES AND NO OTHER REPRESENTATIONS OR CLAIMS OF ANY NATURE SHALL BE BINDING ON OR OBLIGATE ELECTRONIC ARTS. ANY IMPLIED WARRANTIES APPLICABLE TO THIS SOFTWARE PRODUCT, INCLUDING WARRANTIES OF MERCHANTABILITY AND FITNESS FOR A PARTICULAR PURPOSE, ARE LIMITED TO THE NINETY (90) DAY PERIOD DESCRIBED ABOVE. IN NO EVENT WILL ELECTRONIC ARTS BE LIABLE FOR ANY SPECIAL, INCIDENTAL, OR CONSEQUENTIAL DAMAGES RESULTING FROM POSSESSION, USE OR MALFUNCTION OF THIS ELECTRONIC ARTS SOFTWARE PRODUCT.

Some states do not allow limitations as to how long an implied warranty lasts and/or exclusions or limitations of incidental or consequential damages so the above limitations and/or exclusions of liability may not apply to you. This warranty gives you specific rights, and you may also have other rights which vary from state to state.

RETURNS AFTER WARRANTY - To replace defective media after the ninety (90) day warranty period has expired, send the original cartridge to Electronic Arts' address below. Enclose a statement of the defect, your name, your return address, and a check or money order for \$20.00.

Electronic Arts
Customer Warranty
P.O. Box 7578
San Mateo, California 94403-7578

If you need to talk to someone about this product, call us at (415) 572-9448 Monday through Friday between 8:30 am and 4:30 pm, Pacific Time.

In Australia and New Zealand, contact: Electronic Arts Pty. Limited, P.O. Box 432, Southport Qld 4215, Australia. Within Australia call: (075) 711 811. Within New Zealand call: +61 75 711 811 between 9am-5pm Eastern Standard Time.

THIS GAME IS LICENSED BY SEGA ENTERPRISES, LTD. FOR PLAY ON THE SEGA™ GENESIS™ SYSTEM.

SEGA AND GENESIS ARE TRADEMARKS OF SEGA ENTERPRISES, LTD.

Unless indicated otherwise, all software and documentation is © 1993 Electronic Arts. All Rights Reserved.

Team names, logos and helmet designs are registered trademarks of the NFL and its member clubs. EA SPORTS, If it's in the game, it's in the game and Electronic Arts are trademarks of Electronic Arts.

MADDEN NFL '94™ ©1993 Electronic Arts. All rights reserved.

EA SPORTS™

P R E S E N T S



PGA TOUR® GOLF II
IF IT'S ON THE TOUR,
IT'S IN THE GAME!

Now with 7 courses
and 5 PGA TOUR
tournaments. Plus
the ultimate big
money shootout: a
new skins challenge
you can play on any
course! Includes
more stats, the all new draw and fade
meter, and a battery back-up.

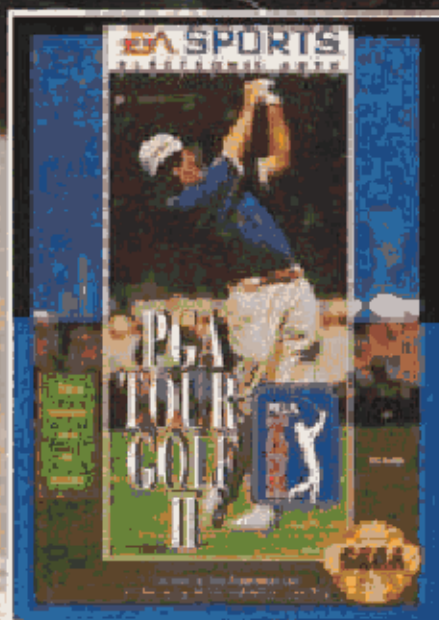

4 WAY PLAY™

Only from EA SPORTS. 4 Way Play lets four players
compete at the same time: 2 on 1, 2 on 2, 3 on 1 or 4
against the computer. Perfect for tournament play!
Look for these 4 Way Play tournament series products:



Madden NFL® '94
NHL® '94
Bill Walsh College Football™
FIFA International Soccer



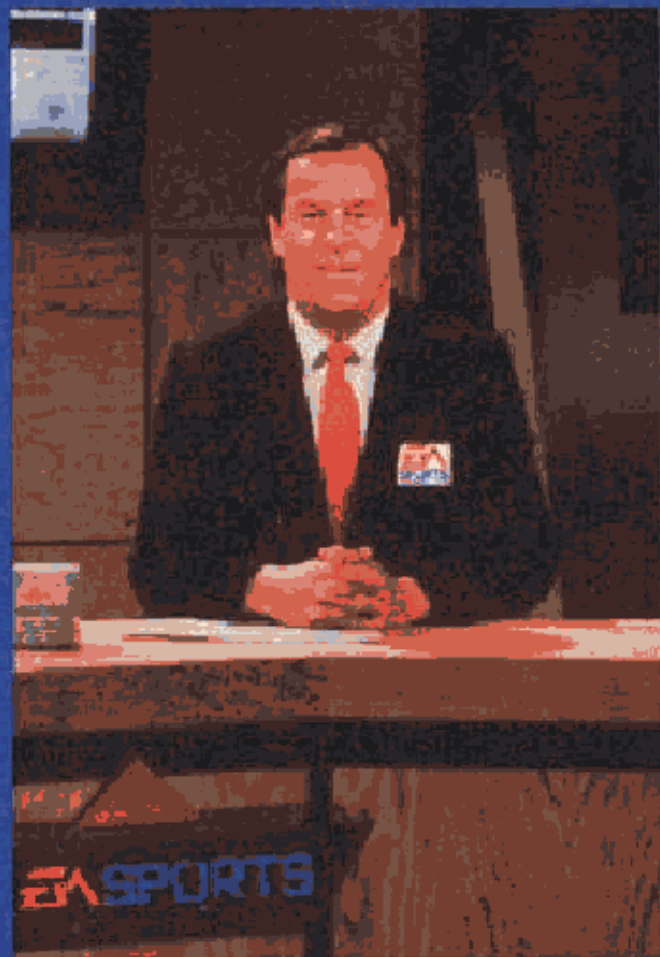

**Ron Barr, sports anchor,
EA SPORTS**

Emmy Award-winning reporter Ron Barr brings over 20 years of professional sportscasting experience to EA SPORTS. His network radio and television credits include play-by-play and color commentary for the NBA, NFL and the Olympic Games.

In addition to covering EA SPORTS sporting events, Ron hosts Sports Byline USA, the premiere sports talk radio show broadcast over 200 U.S. stations and around the world on Armed Forces Radio Network and Radio New Zealand.

Barr's unmatched sports knowledge and enthusiasm afford sports fans everywhere the chance to really get to know their heroes, talk to them directly, and discuss their views in a national forum.



LISTEN IN!

Tune in to SPORTS BYLINE USA for the ELECTRONIC ARTS SPORTS TRIVIA CONTEST for a chance to win a free EA SPORTS game. Check local radio listings.

10:00 p.m. to 1:00 a.m. E.T.
 9:00 p.m. to 12:00 a.m. C.T.
 8:00 p.m. to 11:00 p.m. M.T.
 7:00 p.m. to 10:00 p.m. P.T.