



GENESIS INSTRUCTION MANUAL

GEORGE FOREMAN'S

IKO

BOXING™

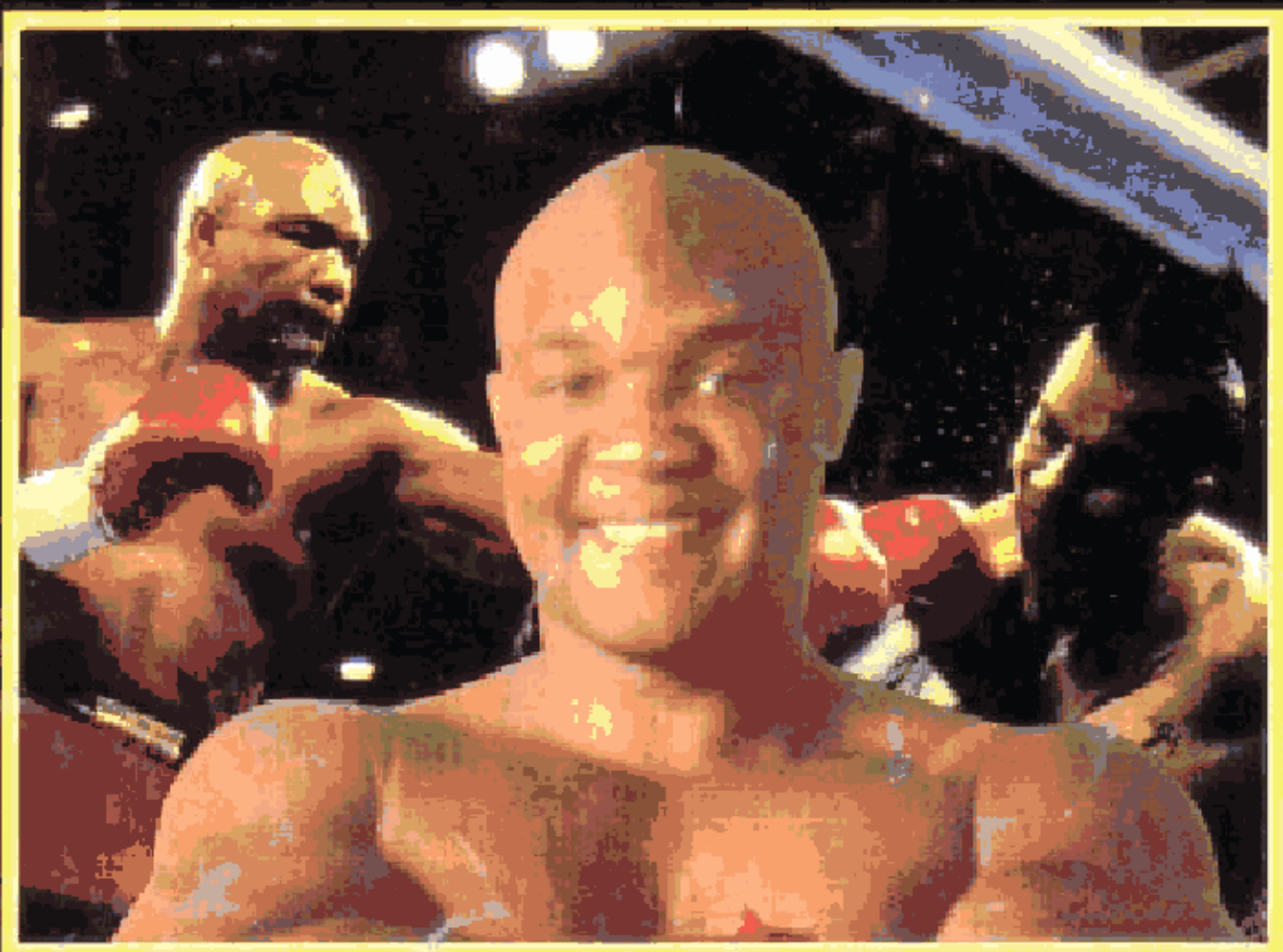

FLYING EDGE™

A Division of Acclaim Entertainment, Inc.



AtariGuide.com



This official seal is your assurance that this product meets the highest quality standards of SEGA™. Buy games and accessories with this seal to be sure that they are compatible with the SEGA™ GENESIS™ SYSTEM.

SEGA and GENESIS are trademarks of Sega Enterprises Ltd.

Handling The Sega Genesis Cartridge

- The Sega Genesis Cartridge is intended for use exclusively for the Sega Genesis System.
- Do not bend it, crush it, or submerge it in liquids.
- Do not leave it in direct sunlight or near a radiator or other source of heat.
- Be sure to take an occasional recess during extended play, to rest yourself and the Sega Cartridge.

Warning to owners of projection televisions: Still pictures or images may cause permanent picture-tube damage or mark the phosphor of the CRT. Avoid repeated or extended use of video games on large-screen projection televisions.

A Heavyweight hero with an appetite for cheeseburgers and the World Heavyweight Boxing Title, George Foreman is back and winning like a true champion! The gregarious 251 lb. fighter has a heart of gold and a fist of granite. Several years ago, few odds makers would have bet on the Foreman comeback, after a ten-year retirement from boxing, but giant George continues to battle much younger opponents. He is formidable, with a wealth of experience and a powerful punch. The goliath Texan started out as a boy in a Houston street gang. He was a mean street fighter, but the first time he put gloves on, he was defeated by a skinny light-heavyweight. Despite his first boxing experience, George returned to the Job Corps fighting ring. And under the supervision of coach Doc Broadus, he became their finest boxer, signing on for the 1968 Olympics. He won the gold medal. Foreman turned professional and at 24, he knocked out Joe Frazier for the Heavyweight Title. He lost the Title in 1974 to the incredible Muhammad Ali. Now He faces younger fighters with a new courage. He began his comeback with an impressive four-round knockout over Steve Zouski in 1987, and followed up with knockouts over Gerry Cooney and Adilson Rodriguez. In the fourth year of his return, Foreman's record is a stunning 26-1, bringing his lifetime boxing record to an astounding 71 wins, 66 knockouts, and 3 losses. No fighter in history can match his official record. Full of good humor, optimism, and junk food, the 43-year-old boxer is a powerhouse on his way to again capturing the Heavyweight Championship Belt!

STARTUP

1. Set up your Sega Genesis System as described in its instructional manual. Plug in Control Pad 1.
2. Make sure the power switch is OFF. Then insert the Sega Cartridge into the console.
3. Turn the power switch ON. In a few moments, the title screen will appear.
4. If the title screen doesn't appear, turn the power switch OFF. Make sure your system is set up correctly and the Cartridge is properly inserted. Then turn the power switch ON again.

Important: Always make sure that the Console is turned OFF when inserting or removing your Genesis Cartridge.

NOTE: GEORGE FOREMAN'S KO BOXING is for one or two players.

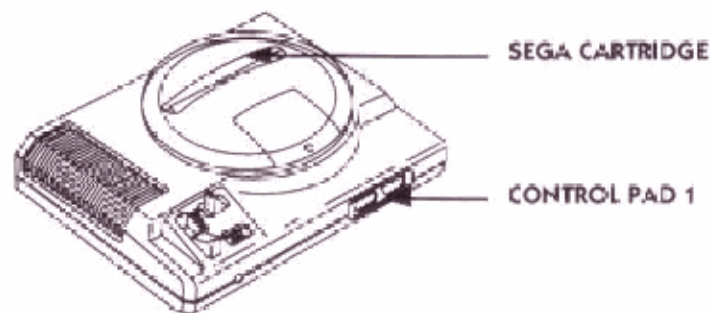

PRE-FIGHT PREPARATIONS

At the title screen, press the **START** button. You will then be shown Options for starting a One Player Game, Two Player Game or using a Password to continue your pursuit of the Title where you left off the last time you played.

Use the **DOWN** or **UP** arrow, on the directional pad, to make a selection and then press **START**.



Note—Before choosing a **TWO PLAYER** game, make sure that you have set up your Sega Genesis System with two controllers.

PASSWORD

Passwords are obtained by the player when a Title Belt is won. Be sure to write them down. A Password will allow you to continue your pursuit of the Title where you left off the last time you played.



You can choose **PASSWORD** from the Option Screen by hitting the DOWN arrow and then pressing **START**. The **PASSWORD** screen will then appear. You will see twelve squares with numbers in a formation, with one square in the center of that formation.

Use the **ARROWS** on the directional pad of your controller to choose a square in which to enter the first number in your **PASSWORD**. Using the **A** and **C** **BUTTONS**, change the number in the center square until it comes to the number that you wish to place in the outer square. Press the **B** **BUTTON** to enter your choice. Now move to the next square.

Do the same for each number in your **PASSWORD** until **ALL** the outer squares are complete. When you have completed your password, press the **START** button and the game will continue where you last left off.

THERE'S THE BELL

Hint: For best game play, become familiar with the different control functions before you start playing.

DIRECTIONAL PAD

(Moves boxer from side to side; directs punches; allows blocking.)

STARTS THE FIGHT

(Pauses the fight in progress.)

DELIVERS SUPERPUNCH

RIGHT PUNCH

LEFT PUNCH

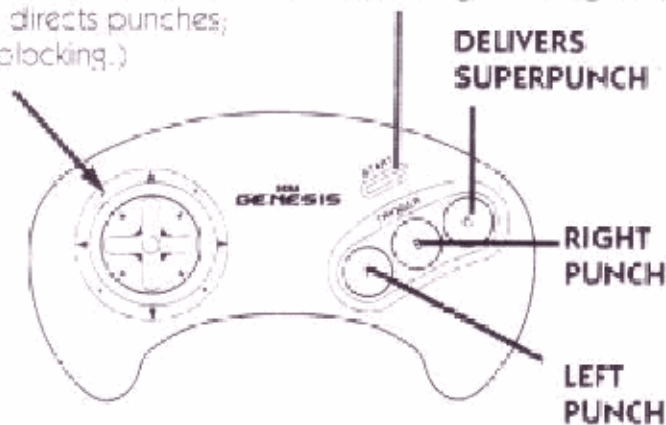

OBJECT OF THE GAME...To defeat all World-ranked Heavyweight contenders, winning all four Championship belts to capture the Heavyweight Title of the World!

FIGHTING MOVES

DIRECTIONAL PAD

(Dodge punches from your opponent.)

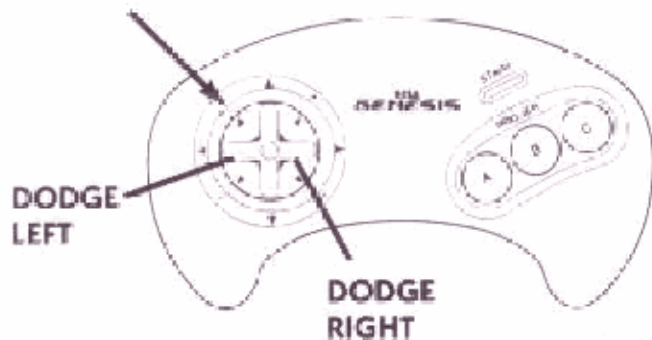

PUNCHES, BLOCKING and RECOVERY

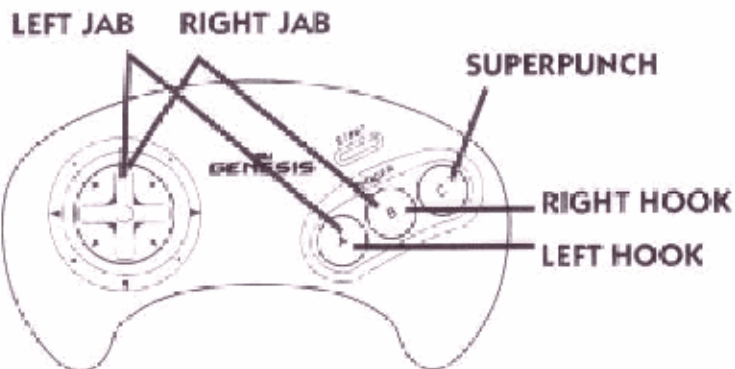

DOWN ARROW Blocks a punch from your opponent



SUPERPUNCH... Press the **C** BUTTON to deliver the Superpunch to your opponent. Superpunches are earned by striking your opponent with one of several combinations of punches. They are indicated by red boxing gloves in the upper left-hand corner of the fighting screen. **Hint: Used at the right moment, a SUPERPUNCH can have a devastating effect on your opponent.**

REFEREE'S COUNT...

When a knockdown is scored the boxer will have until the count of 10, from the referee, to get up (see **RECOVERY**) and continue the fight.

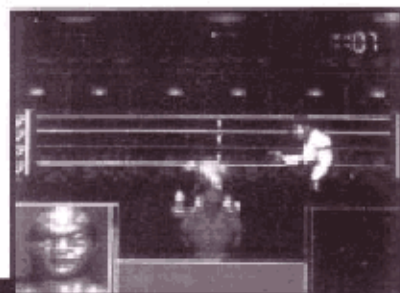

RECOVERY... When your opponent knocks you down, you **MUST** act quickly by rapidly tapping the **A** and **B** **BUTTONS** alternately, in order to get up from the canvas and stay in the bout.

TWO PLAYER GAME

In a **TWO PLAYER** game, player 1 controls George Foreman. After choosing the **TWO PLAYER GAME**

selection from the Option screen, Player 2 can select the fighter of his choice by using the **LEFT** and **RIGHT** arrows on the Fighter Profile screens and choose by pressing the **START** button.

Two player games are single bouts and not connected with the Heavyweight Title Belts.



THE MAIN EVENT

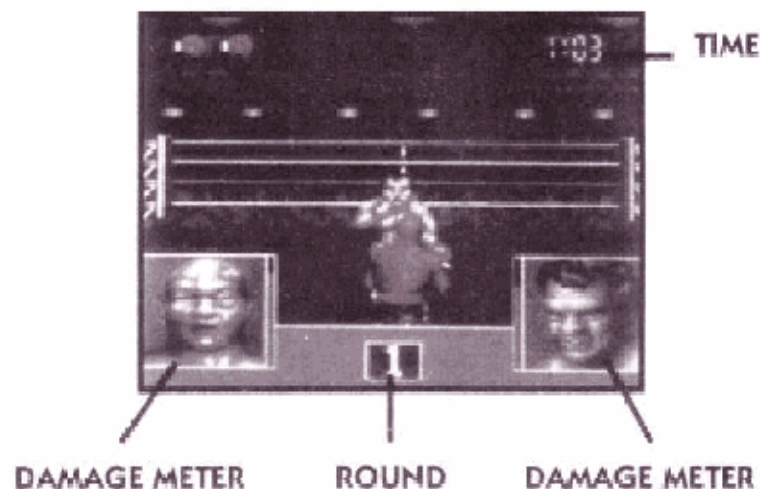

DAMAGE METERS: The boxers' faces in the bottom corners of the screen are the Damage Meters and indicate how badly your fighter is hurt and how much damage your opponent has sustained. The more severe the damage a boxer sustains, the more his meter shades over, twinkling when the boxer is in real trouble. Keeping an eye on the damage helps you determine who is ahead or more susceptible to a **KNOCKDOWN** or **KNOCK-OUT**.

TIME... Located in the top-right of the screen, you will find the official time clock. It shows the time remaining in the round. Each round is three minutes long.

ROUND... Displayed in the lower-center of the screen is the current Round number of the fight. There are only



three rounds to each bout so get right to it! Don't save your best stuff for the later rounds.

SUPERPUNCHES... If you've trained properly you'll a ways know to find your Superpunches in the upper left-hand corner of the fighting screen.

THE COMPETITION



Lorenzo "Bullet" Luciano

Profile: A veteran journeyman in the boxing world. Nicknamed "Bullet" for his lightning quick jabs and fast footwork. A tough, keen boxer who's been around.



Tony "Tornado" Collins

Profile: Making first appearance since receiving severe punishment in his last fight. Tommy is determined to prove the critics wrong and show that he's a quality fighter.



Renko "The Boss" Fujioka

Profile: Young unorthodox fighter from the Far East who had a brilliant international amateur career. He has good hand speed but up to now has lacked knockout power.



Sonny Joe Dukas

Profile: Not considered to be one of the greats in the heavyweight division. But like anyone his size he can put you down with one lucky punch.



"Earthquake" Harley

Profile: No one knows whether he got the nickname "Earthquake" because of the power he possesses or because he's simply cracked. Watch out...



"Terrible" Turak

Profile: Turak used to be a professional wrestler but found it wasn't satisfying enough. He likes to knockout his opponents as his record shows, not just pin them.



Lance "The Sheik" Borque

Profile: Lance is a real veteran of the sport who has fought all the great ones. Over the years he has developed a real mean temper which usually peaks when he's losing.



**Eddy "The Pirate" Preston**

Profile: "The Pirate" isn't much for small talk. He usually lets his fists speak for him. He's a tough, well-trained boxer with his eye on the championship.

**"Beautiful" Bobby Crane**

Profile: Bobby is the pretty boy of heavyweight boxing. He's a successful model and actor who needs to keep his good looks. Don't damage his face...he'll get real mad.

**"Crazy" Miguel Valdez**

Profile: Miguel comes from a family of circus trapeze artists. They say he also does some crazy stunts in the air. So watch out for him in the ring.

**"Irish" Tommy Morton**

Profile: A seasoned boxer who fought his way out of the pubs in Ireland, Tommy has learned not to give in to anyone. It's usually his opponents who end up face down.

**Tyrone "Madman" Mosley**

Profile: Just as his nickname indicates, Tyrone is a real crazy character capable of doing anything at any time.

**Larry "The Surgeon" Scott**

Profile: Not only did he earn his nickname because of his surgical disposal of his opponents, but also because he cuts like a knife.

**Ray "The Iceman" Armstrong**

Profile: They call him "The Iceman" because he shows no emotion or pain and he's cold and calculated in the ring. Ray is one of the best tactical boxers you'll come across.

**Brixton "Mohawk" Morris**

Profile: It's been quite a while since "Mohawk" tasted defeat and he doesn't plan on adding it back into his diet anytime soon.

THE WINNER and NEW CHAMPION...

KNOCKOUTS: Knock down your opponent 4 times in a fight and you win the bout.

TECHNICAL KNOCKOUTS: Knock down your opponent 3 times in a given ROUND to win the BOUT.

WINNING BY DECISION: The winner of the 3 ROUNDS in terms of punches landed and overall command of those rounds, wins by decision. A JUDGE'S DECISION will take place if both boxers go the full 3 ROUNDS.

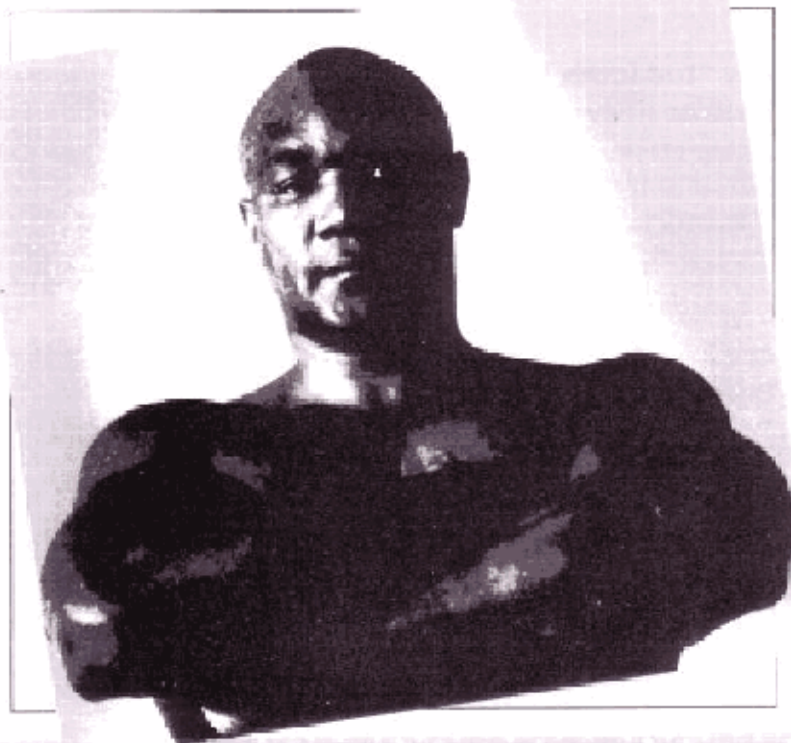

DEFEAT

If your opponent knocks you out **3 times in a ROUND**, he wins the BOUT.

If your opponent knocks you down **4 times in a given FIGHT**, he wins the BOUT.

Your opponent wins by decision if he obtains a superior overall number of points from **KNOCKOUTS**, **TECHNICAL KNOCKOUTS**, and **DAMAGE** done to you.

If you cannot successfully get Foreman up from a knockdown, by repeatedly pressing the **A and B buttons**, you lose the BOUT.

Note: Lose twice to the same boxer and the game will end.

REMATCH

If you lose a fight, you must fight the last opponent that you've beaten. If you lose that fight, the game is over. Try starting over and begin looking for a new trainer.



WINNING THE CHAMPIONSHIP BELT

You'll have to defeat all pretenders and contenders in four different professional boxing circuits to become the first champion to win the coveted Quadruple Crown of heavyweight boxing represented by the International Championship Belt.



WIN AGAINST ALL TOP-RANKED HEAVYWEIGHT CONTENDERS AND BE THE UNDISPUTED HEAVYWEIGHT CHAMPION OF THE WORLD!

THE FOREMAN COMEBACK

George Foreman is flying high on the comeback trail! Pumped up and in shape, the Texan colossus of boxing is facing high-ranked contenders for the Heavyweight throne. In his brutal winning battle against Alex Stewart, Foreman proved the seriousness of his relentless drive toward the Title. He will not back down! Focused with the concentration of an experienced champion, it will be tough for any boxer to go the



distance against George Foreman. You're calling the shots from ringside. You know you can win! With careful strategy, the right combinations, and the right moves, you can take on all contenders for the Heavyweight Championship Title. Your opponents are determined. They're younger fighters with sharp fighting technique, but George Foreman and you will bring them down for the count, one by one! The crowd is excited! The referee is ready. There's the bell.

FLYING EDGE (A Division of Acclaim Entertainment, Inc.) LIMITED WARRANTY

Flying Edge warrants to the original purchaser only of this Flying Edge software product that the medium on which this computer program is recorded is free from defects in materials and workmanship for a period of ninety (90) days from the date of purchase. This Flying Edge software program is sold "as is," without express or implied warranty of any kind, and Flying Edge is not liable for any losses or damages of any kind resulting from use of this program. Flying Edge agrees for a period of ninety (90) days to either repair or replace, at its option, free of charge, any Flying Edge software product, postage paid with proof of date of purchase, at its Factory Service Center. Replacement of the Cartridge, free of charge to the original purchaser (except for the cost of returning the Cartridge), a full extent of our liability.

This warranty is not applicable to normal wear and tear. This warranty shall not be applicable and shall be void if defect in the Flying Edge software product has arisen through abuse, unreasonable use, mistreatment or neglect. THIS WARRANTY IS IN LIEU OF ALL OTHER WARRANTIES AND NO OTHER REPRESENTATIONS OR CLAIMS OF ANY NATURE SHALL BE BINDING ON OR OBLIGATE FLYING EDGE. ANY IMPLIED WARRANTIES APPLICABLE TO THIS SOFTWARE PRODUCT INCLUDING WARRANTIES OF MERCHANTABILITY AND FITNESS FOR A PARTICULAR PURPOSE ARE LIMITED TO THE NINETY (90) DAY PERIOD DESCRIBED ABOVE. IN NO EVENT WILL FLYING EDGE BE LIABLE FOR ANY SPECIAL, INCIDENTAL, OR CONSEQUENTIAL DAMAGES RESULTING FROM POSSESSION, USE OR MALFUNCTION OF THIS FLYING EDGE SOFTWARE PRODUCT.

Some states do not allow limitations as to how long an implied warranty lasts and/or exclusions or limitations of incidental or consequential damages so the above limitations and/or exclusions of liability may not apply to you. This warranty gives you specific rights, and you may also have other rights which vary from state to state.

This warranty shall not be applicable to the extent that any provision of this warranty is prohibited by any federal, state or municipal law which cannot be pre-empted.

RETURNS AFTER WARRANTY - To replace defective media after the ninety (90) day warranty period has expired, send the original Cartridge to Flying Edge at the address below via UPS or registered mail. Enclose a statement of the defect, your name, your return address and a check or money order for \$20.00. Flying Edge, Consumer Service Dept., 71 Audrey Avenue, Oyster Bay, NY 11771

COMPLIANCE WITH FCC REGULATIONS

This equipment generates and uses radio frequency energy and if not installed and used properly, that is, in strict accordance with the manufacturer's instructions, may cause interference to radio and television reception. It has been type tested and found to comply with the limits for a Class B computing device in accordance with the specifications in Subpart J of Part 15 of FCC Rules which are designed to provide reasonable protection against such interference in a residential installation. However, there is no guarantee that interference will not occur in a particular installation. If this equipment does cause interference to radio or television reception, which can be determined by turning the equipment off and on, the user is encouraged to try and correct the interference by one or more of the following measures:

- Reorient the receiving antenna
- Relocate the Genesis with respect to the receiver
- Move the Genesis away from the receiver
- Plug the Genesis into a different outlet so that the computer and receiver are on different circuits

If necessary, the user should consult an experienced radio/television technician for additional suggestions. The user may find the following booklet prepared by the Federal Communications Commission helpful: "How to Identify and Resolve Radio/TV Interference Problems." This booklet is available from the U.S. Government Printing Office, Washington, DC 20403. Stock No. 004-000-00345-4

Flying Edge Hotline (516) 624-9300

Distributed and marketed by Acclaim Entertainment, Inc.
71 Audrey Avenue, Oyster Bay, N.Y. 11771.

Genesis and Genesis are trademarks of Sega Enterprises Ltd. George Foreman's KO Boxing™ & Flying Edge™ are trademarks of Acclaim Entertainment, Inc. © 1992 Acclaim Entertainment, Inc. All rights reserved.

FLYING EDGE™ GAME PAK WARRANTY REGISTRATION CARD

Fill out and mail this coupon to receive a FREE copy of the "Masters of the Game" magazine with information and tips on our hot new titles and products!

Name: _____

Phone: () _____ Date: _____

Street Address: _____

City, State, Zip: _____

1. Game title: George Foreman's KO Boxing GENESIS

2. Who purchased this game? Male Female Age _____

3. Who plays this game the most? Male Female Age _____

4. Why was game purchased for player?
 Self purchase Requested gift Unrequested gift

5. How did you hear about this game?
 Friend Radio TV Newspaper Magazine Ad

Game Review In-Store Display
 Played Before Buying Arcade Sales Person

6. How would you rate the game play?
1 2 3 4 5 6 7 8 9 10 (Best)

7. How would you rate the graphics?
1 2 3 4 5 6 7 8 9 10 (Best)

8. Which kind of game do you like the most?
 Action Role Playing Sports

Simulation Maze/Puzzle

9. How often do you play coin-op arcade games?
 Never Sometimes Frequently

10. What game/computer systems are in your household?
 NES Super NES Genesis Game Gear

Game Boy PC (IBM or other)

11. How many times a month do you rent video games? _____

12. Which magazines and comic books do you read?

13. Comments: _____

Send to: Flying Edge
P.O. Box 9003
Oyster Bay, NY 11771-9003

Cut along dotted line and send to: _____



ROGER CLEMENS MVP BASEBALL

Feel the heat! Three time Cy Young Award winner Roger "The Rocket" Clemens blazes home the best in Genesis baseball action!



STEP UP TO THE PLATE!
With enhanced graphics, sound and player control!

**FLYING
EDGE**
A Division of Acclaim Entertainment, Inc.



SUPER HIGH IMPACT

When you're tired of watching football from the sidelines...get into the **button-pounding arcade action** of SUPER HIGH IMPACT!!



Bone crunching football action straight from the arcade *SMASH!!*

**ARENA
ENTERTAINMENT**

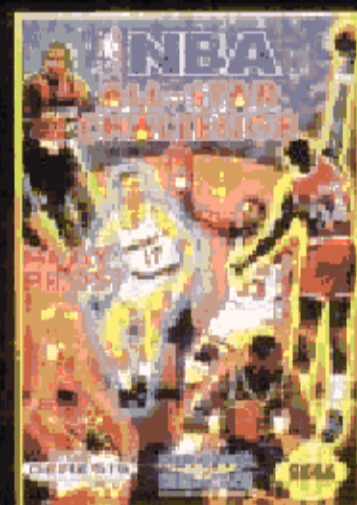

NBA ALL-STAR CHALLENGE

Downtown or in the paint, take on 27 of the NBA's hottest stars in slammin', jammin' One² on-One competition!

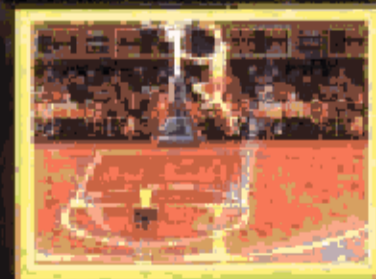

Take it to the hoop with One-on-One, H.O.R.S.E., 3 Point Shoot Out, and more!

**FLYING
EDGE**
A Division of Acclaim Entertainment, Inc.

Roger Clemens' MVP™ Baseball™ is a trademark of LJM, Ltd. ©1992 LJM, Ltd. All rights reserved. Super High Impact™ ©1991, 1992 Midway® Manufacturing Company. Arena Entertainment is a trademark of Arena Entertainment. All NBA and Team Insignias depicted are the properties of the respective NBA Teams and NBA Properties, Inc. All-Star Challenge™ is a trademark of LJM, Ltd. Flying Edge™ is a trademark of Acclaim Entertainment, Inc.

Flying Edge is a Division of Acclaim Entertainment, 71 Audrey Avenue, Oyster Bay, N.Y.

Licensed by Sega Enterprises Ltd. for play on the Sega™ Genesis™ System. Sega and Genesis are trademarks of Sega Enterprises Ltd. Printed in Japan.