



NTSC U/C

PlayStation®



GRAN TURISMO™



1 disc



SETTING UP

Set up your PlayStation® according to the instructions in its Instruction Manual. Insert the GRAN TURISMO™ disc and close the Disc cover. Turn the PlayStation® ON at the POWER button. **It is advised that you do not insert or remove peripherals or Memory cards once the power is turned on.** Make sure there are enough free blocks on your Memory card before commencing play.

SELECTING A LANGUAGE

Use the Directional buttons to highlight your language and press the X button to select the language and advance to the Main Menu. PLEASE NOTE: It is not possible to change your language in-game after this point.

MAIN MENU

SELECTING THE MODE AND MENU

MAIN MENU

After the Start-up sequence, the Main Menu appears. The Main Menu is where you select from two different race modes, and where you can select the replay and setting menus.

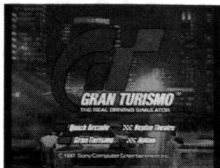

QUICK ARCADE	A fast, accessible yet authentic racing game
GRAN TURISMO	Immerse yourself in a completely realistic racing experience
REPLAY THEATER	Play and manage your replay data
OPTION	Alter the game's various settings

HOW TO PLAY GRAN TURISMO™

5) USING AN ANALOG CONTROLLER (DUAL SHOCK)

The Analog Controller (DUAL SHOCK) offers superb analog handling and control whilst boasting the additional feature of a double-frequency vibration mechanism, bringing an added level of realism to the most accurate racing simulation ever.

MENU OPERATIONS

Directional buttons	MOVE CURSOR
□ button	CANCEL
△ button	CANCEL
○ button	SELECT / CONFIRM
× button	SELECT / CONFIRM

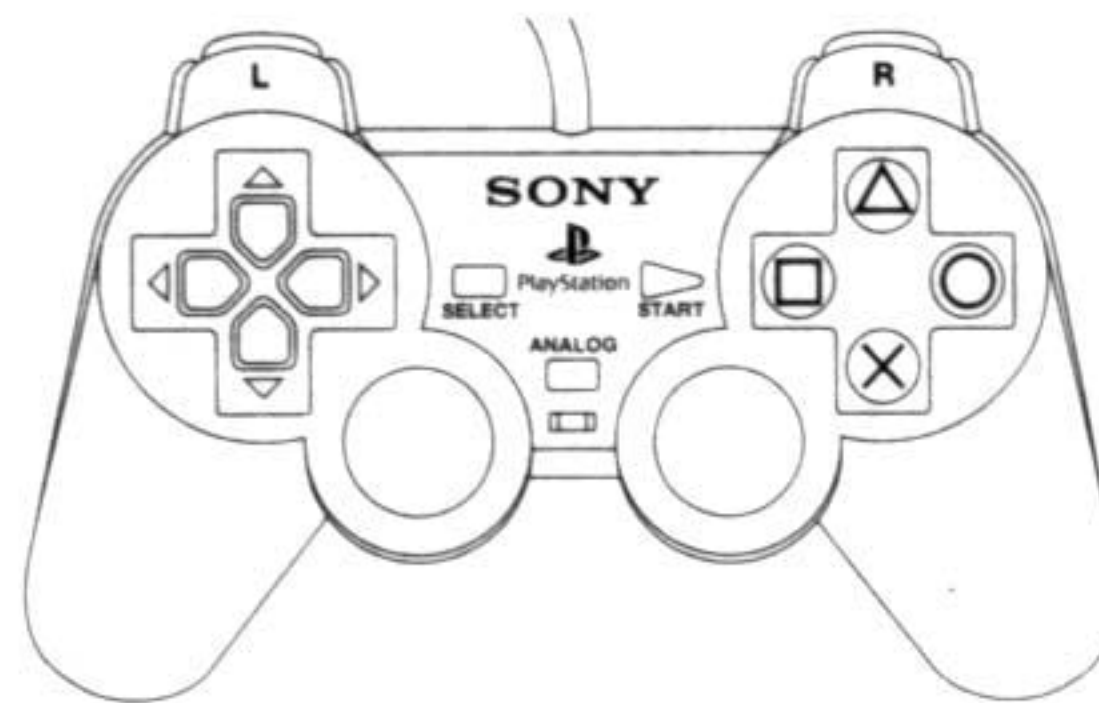

RACING OPERATIONS

Before commencing a race, select the ANALOG mode on the Analog Controller (DUAL SHOCK) - the LED will light up RED:

L1 button	REAR VIEW	○ button	HAND-BRAKE
L2 button	SHIFT DOWN	× button	ACCELERATE
R2 button	SHIFT UP	□ button	BRAKE
R1 button	CHANGE VIEW	START button	PAUSE
△ button	REVERSE	Left stick	STEER

• The configurations above are the default settings, and can be changed on the OPTION menu.

• To unpause the game, select CONTINUE from the Pause menu.

• To end the race from the Pause menu, select GAME END.

ii) USING A CONTROLLER

GRAN TURISMO™ can also be played using a Controller (digital). All operations are identical to those of the Analog Controller (DUAL SHOCK), except for steering when in a race:

Directional buttons STEER



iii) USING A neGcon™

MENU OPERATIONS

Directional buttons	MOVE CURSOR
II button	CANCEL
B button	CANCEL
A button	SELECT / CONFIRM
I button	SELECT / CONFIRM

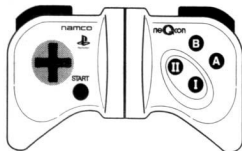

RACING OPERATIONS

UP Directional button	SHIFT UP	B button	REVERSE
DOWN Directional button	SHIFT DOWN	A button	HAND-BRAKE
L button	REAR VIEW	I button	ACCELERATE
Twist	STEER	II button	BRAKE
R button	CHANGE VIEW	START button	PAUSE

NOTE: For operating instructions, refer to the instruction manual supplied with your neGcon™. The configuration above are the default settings, and can be changed on the OPTION menu.

THE RACE SCREEN

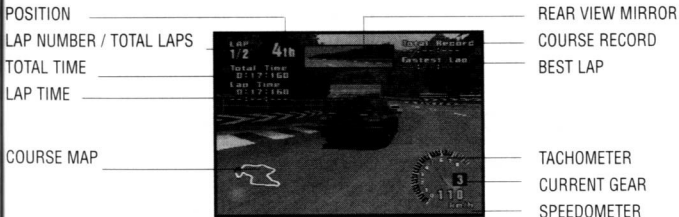

NOTES: The rear view mirror is only available in DRIVER view. On the course map, your position is indicated in red, and your opponents' positions are indicated in green. The screen composition may vary slightly according to the type of race.

REPLAY MODE

THE REPLAY SCREEN

By playing replay data, you can view race replays any time you wish. While replaying, you can change the view or the car being tracked. Use this feature to analyse your own racing style objectively and compare it to other drivers.

REPLAY OPERATIONS: CONTROLLER / ANALOG CONTROLLER (DUAL SHOCK)

UP/DOWN Directional buttons	CHANGE CAR BEING TRACKED	△ button	CHANGE VIEW
START button	END REPLAY	○ button	CHANGE VIEW
		× button	CHANGE VIEW
		□ button	CHANGE VIEW

0
 1
 2
 3
 4
 5
 6
 7
 8
 9
 A
 B
 C
 D
 E
 F
 G
 H
 I
 J
 K
 L
 M
 N
 O
 P
 Q
 R
 S
 T
 U
 V
 W
 X
 Y
 Z
 0
 1
 2
 3
 4
 5
 6
 7
 8
 9
 A
 B
 C
 D
 E
 F
 G
 H
 I
 J
 K
 L
 M
 N
 O
 P
 Q
 R
 S
 T
 U
 V
 W
 X
 Y
 Z
 0
 1
 2
 3
 4
 5
 6
 7
 8
 9
 A
 B
 C
 D
 E
 F
 G
 H
 I
 J
 K
 L
 M
 N
 O
 P
 Q
 R
 S
 T
 U
 V
 W
 X
 Y
 Z
 0
 1
 2
 3
 4
 5
 6
 7
 8
 9
 A
 B
 C
 D
 E
 F
 G
 H
 I
 J
 K
 L
 M
 N
 O
 P
 Q
 R
 S
 T
 U
 V
 W
 X
 Y
 Z
 0
 1
 2
 3
 4
 5
 6
 7
 8
 9
 A
 B
 C
 D
 E
 F
 G
 H
 I
 J
 K
 L
 M
 N
 O
 P
 Q
 R
 S
 T
 U
 V
 W
 X
 Y
 Z
 0
 1
 2
 3
 4
 5
 6
 7
 8
 9
 A
 B
 C
 D
 E
 F
 G
 H
 I
 J
 K
 L
 M
 N
 O
 P
 Q
 R
 S
 T
 U
 V
 W
 X
 Y
 Z
 0
 1
 2
 3
 4
 5
 6
 7
 8
 9
 A
 B
 C
 D
 E
 F
 G
 H
 I
 J
 K
 L
 M
 N
 O
 P
 Q
 R
 S
 T
 U
 V
 W
 X
 Y
 Z
 0
 1
 2
 3
 4
 5
 6
 7
 8
 9
 A
 B
 C
 D
 E
 F
 G
 H
 I
 J
 K
 L
 M
 N
 O
 P
 Q
 R
 S
 T
 U
 V
 W
 X
 Y
 Z
 0
 1
 2
 3
 4
 5
 6
 7
 8
 9
 A
 B
 C
 D
 E
 F
 G
 H
 I
 J
 K
 L
 M
 N
 O
 P
 Q
 R
 S
 T
 U
 V
 W
 X
 Y
 Z
 0
 1
 2
 3
 4
 5
 6
 7
 8
 9
 A
 B
 C
 D
 E
 F
 G
 H
 I
 J
 K
 L
 M
 N
 O
 P
 Q
 R
 S
 T
 U
 V
 W
 X
 Y
 Z
 0
 1
 2
 3
 4
 5
 6
 7
 8
 9
 A
 B
 C
 D
 E
 F
 G
 H
 I
 J
 K
 L
 M
 N
 O
 P
 Q
 R
 S
 T
 U
 V
 W
 X
 Y
 Z
 0
 1
 2
 3
 4
 5
 6
 7
 8
 9
 A
 B
 C
 D
 E
 F
 G
 H
 I
 J
 K
 L
 M
 N
 O
 P
 Q
 R
 S
 T
 U
 V
 W
 X
 Y
 Z
 0
 1
 2
 3
 4
 5
 6
 7
 8
 9
 A
 B
 C
 D
 E
 F
 G
 H
 I
 J
 K
 L
 M
 N
 O
 P
 Q
 R
 S
 T
 U
 V
 W
 X
 Y
 Z
 0
 1
 2
 3
 4
 5
 6
 7
 8
 9
 A
 B
 C
 D
 E
 F
 G
 H
 I
 J
 K
 L
 M
 N
 O
 P
 Q
 R
 S
 T
 U
 V
 W
 X
 Y
 Z
 0
 1
 2
 3
 4
 5
 6
 7
 8
 9
 A
 B
 C
 D
 E
 F
 G
 H
 I
 J
 K
 L
 M
 N
 O
 P
 Q
 R
 S
 T
 U
 V
 W
 X
 Y
 Z
 0
 1
 2
 3
 4
 5
 6
 7
 8
 9
 A
 B
 C
 D
 E
 F
 G
 H
 I
 J
 K
 L
 M
 N
 O
 P
 Q
 R
 S
 T
 U
 V
 W
 X
 Y
 Z
 0
 1
 2
 3
 4
 5
 6
 7
 8
 9
 A
 B
 C
 D
 E
 F
 G
 H
 I
 J
 K
 L
 M
 N
 O
 P
 Q
 R
 S
 T
 U
 V
 W
 X
 Y
 Z
 0
 1
 2
 3
 4
 5
 6
 7
 8
 9
 A
 B
 C
 D
 E
 F
 G
 H
 I
 J
 K
 L
 M
 N
 O
 P
 Q
 R
 S
 T
 U
 V
 W
 X
 Y
 Z
 0
 1
 2
 3
 4
 5
 6
 7
 8
 9
 A
 B
 C
 D
 E
 F
 G
 H
 I
 J
 K
 L
 M
 N
 O
 P
 Q
 R
 S
 T
 U
 V
 W
 X
 Y
 Z
 0
 1
 2
 3
 4
 5
 6
 7
 8
 9
 A
 B
 C
 D
 E
 F
 G
 H
 I
 J
 K
 L
 M
 N
 O
 P
 Q
 R
 S
 T
 U
 V
 W
 X
 Y
 Z
 0
 1
 2
 3
 4
 5
 6
 7
 8
 9
 A
 B
 C
 D
 E
 F
 G
 H
 I
 J
 K
 L
 M
 N
 O
 P
 Q
 R
 S
 T
 U
 V
 W
 X
 Y
 Z
 0
 1
 2
 3
 4
 5
 6
 7
 8
 9
 A
 B
 C
 D
 E
 F
 G
 H
 I
 J
 K
 L
 M
 N
 O
 P
 Q
 R
 S
 T
 U
 V
 W
 X
 Y
 Z
 0
 1
 2
 3
 4
 5
 6
 7
 8
 9
 A
 B
 C
 D
 E
 F
 G
 H
 I
 J
 K
 L
 M
 N
 O
 P
 Q
 R
 S
 T
 U
 V
 W
 X
 Y
 Z
 0
 1
 2
 3
 4
 5
 6
 7
 8
 9
 A
 B
 C
 D
 E
 F
 G
 H
 I
 J
 K
 L
 M
 N
 O
 P
 Q
 R
 S
 T
 U
 V
 W
 X
 Y
 Z
 0
 1
 2
 3
 4
 5
 6
 7
 8
 9
 A
 B
 C
 D
 E
 F
 G
 H
 I
 J
 K
 L
 M
 N
 O
 P
 Q
 R
 S
 T
 U
 V
 W
 X
 Y
 Z
 0
 1
 2
 3
 4
 5
 6
 7
 8
 9
 A
 B
 C
 D
 E
 F
 G
 H
 I
 J
 K
 L
 M
 N
 O
 P
 Q
 R
 S
 T
 U
 V
 W
 X
 Y
 Z
 0
 1
 2
 3
 4
 5
 6
 7
 8
 9
 A
 B
 C
 D
 E
 F
 G
 H
 I
 J
 K
 L
 M
 N
 O
 P
 Q
 R
 S
 T
 U
 V
 W
 X
 Y
 Z
 0
 1
 2
 3
 4
 5
 6
 7
 8
 9
 A
 B
 C
 D
 E
 F
 G
 H
 I
 J
 K
 L
 M
 N
 O
 P
 Q
 R
 S
 T
 U
 V
 W
 X
 Y
 Z
 0
 1
 2
 3
 4
 5
 6
 7
 8
 9
 A
 B
 C
 D
 E
 F
 G
 H
 I
 J
 K
 L
 M
 N
 O
 P
 Q
 R
 S
 T
 U
 V
 W
 X
 Y
 Z
 0
 1
 2
 3
 4
 5
 6
 7
 8
 9
 A
 B
 C
 D
 E
 F
 G
 H
 I
 J
 K
 L
 M
 N
 O
 P
 Q
 R
 S
 T
 U
 V
 W
 X
 Y
 Z
 0
 1
 2
 3
 4
 5
 6
 7
 8
 9
 A
 B
 C
 D
 E
 F
 G
 H
 I
 J
 K
 L
 M
 N
 O
 P
 Q
 R
 S
 T
 U
 V
 W
 X
 Y
 Z
 0
 1
 2
 3
 4
 5
 6
 7
 8
 9
 A
 B
 C
 D
 E
 F
 G
 H
 I
 J
 K
 L
 M
 N
 O
 P
 Q
 R
 S
 T
 U
 V
 W
 X
 Y
 Z
 0
 1
 2
 3
 4
 5
 6
 7
 8
 9
 A
 B
 C
 D
 E
 F
 G
 H
 I
 J
 K
 L
 M
 N
 O
 P
 Q
 R
 S
 T
 U
 V
 W
 X
 Y
 Z
 0
 1
 2
 3
 4
 5
 6
 7
 8
 9
 A
 B
 C
 D
 E
 F
 G
 H
 I
 J
 K
 L
 M
 N
 O
 P
 Q
 R
 S
 T
 U
 V
 W
 X
 Y
 Z
 0
 1
 2
 3
 4
 5
 6
 7
 8
 9
 A
 B
 C
 D
 E
 F
 G
 H
 I
 J
 K
 L
 M
 N
 O
 P
 Q
 R
 S
 T
 U
 V
 W
 X
 Y
 Z
 0
 1
 2
 3
 4
 5
 6
 7
 8
 9
 A
 B
 C
 D
 E
 F
 G
 H
 I
 J
 K
 L
 M
 N
 O
 P
 Q
 R
 S
 T
 U
 V
 W
 X
 Y
 Z
 0
 1
 2
 3
 4
 5
 6
 7
 8
 9
 A
 B
 C
 D
 E
 F
 G
 H
 I
 J
 K
 L
 M
 N
 O
 P
 Q
 R
 S
 T
 U
 V
 W
 X
 Y
 Z
 0
 1
 2
 3
 4
 5
 6
 7
 8
 9
 A
 B
 C
 D
 E
 F
 G
 H
 I
 J
 K
 L
 M
 N
 O
 P
 Q
 R
 S
 T
 U
 V
 W
 X
 Y
 Z
 0
 1
 2
 3
 4
 5
 6
 7
 8
 9
 A
 B
 C
 D
 E
 F
 G
 H
 I
 J
 K
 L
 M
 N
 O
 P
 Q
 R
 S
 T
 U
 V
 W
 X
 Y
 Z
 0
 1
 2
 3
 4
 5
 6
 7
 8
 9
 A
 B
 C
 D
 E
 F
 G
 H
 I
 J
 K
 L
 M
 N
 O
 P
 Q
 R
 S
 T
 U
 V
 W
 X
 Y
 Z
 0
 1
 2
 3
 4
 5
 6
 7
 8
 9
 A
 B
 C
 D
 E
 F
 G
 H
 I
 J
 K
 L
 M
 N
 O
 P
 Q
 R
 S
 T
 U
 V
 W
 X
 Y
 Z
 0
 1
 2
 3
 4
 5
 6
 7
 8
 9
 A
 B
 C
 D
 E
 F
 G
 H
 I
 J
 K
 L
 M
 N
 O
 P
 Q
 R
 S
 T
 U
 V
 W
 X
 Y
 Z
 0
 1
 2
 3
 4
 5
 6
 7
 8
 9
 A
 B
 C
 D
 E
 F
 G
 H
 I
 J
 K
 L
 M
 N
 O
 P
 Q
 R
 S
 T
 U
 V
 W
 X
 Y
 Z
 0
 1
 2
 3
 4
 5
 6
 7
 8
 9
 A
 B
 C
 D
 E
 F
 G
 H
 I
 J
 K
 L
 M
 N
 O
 P
 Q
 R
 S
 T
 U
 V
 W
 X
 Y
 Z
 0
 1
 2
 3
 4
 5
 6
 7
 8
 9
 A
 B
 C
 D
 E
 F
 G
 H
 I
 J
 K
 L
 M
 N
 O
 P
 Q
 R
 S
 T
 U
 V
 W
 X
 Y
 Z
 0
 1
 2
 3
 4
 5
 6
 7
 8
 9
 A
 B
 C
 D
 E
 F
 G
 H
 I
 J
 K
 L
 M
 N
 O
 P
 Q
 R
 S
 T
 U
 V
 W
 X
 Y
 Z
 0
 1
 2
 3
 4
 5
 6
 7
 8
 9
 A
 B
 C
 D
 E
 F
 G
 H
 I
 J
 K
 L
 M
 N
 O
 P
 Q
 R
 S
 T
 U
 V
 W
 X
 Y
 Z
 0
 1
 2
 3
 4
 5
 6
 7
 8
 9
 A
 B
 C
 D
 E
 F
 G
 H
 I
 J
 K
 L
 M
 N
 O
 P
 Q
 R
 S
 T
 U
 V
 W
 X
 Y
 Z
 0
 1
 2
 3
 4
 5
 6
 7
 8
 9
 A
 B
 C
 D
 E
 F
 G
 H
 I
 J
 K
 L
 M
 N
 O
 P
 Q
 R
 S
 T
 U
 V
 W
 X
 Y
 Z
 0
 1
 2
 3
 4
 5
 6
 7
 8
 9
 A
 B
 C
 D
 E
 F
 G
 H
 I
 J
 K
 L
 M
 N
 O
 P
 Q
 R
 S
 T
 U
 V
 W
 X
 Y
 Z
 0
 1
 2
 3
 4
 5
 6
 7
 8
 9
 A
 B
 C
 D
 E
 F
 G
 H
 I
 J
 K
 L
 M
 N
 O
 P
 Q
 R
 S
 T
 U
 V
 W
 X
 Y
 Z
 0
 1
 2
 3
 4
 5
 6
 7
 8
 9
 A
 B
 C
 D
 E
 F
 G
 H
 I
 J
 K
 L
 M
 N
 O
 P
 Q
 R
 S
 T
 U
 V
 W
 X
 Y
 Z
 0
 1
 2
 3
 4
 5
 6
 7
 8
 9
 A
 B
 C
 D
 E
 F
 G
 H
 I
 J
 K
 L
 M
 N
 O
 P
 Q
 R
 S
 T
 U
 V
 W
 X
 Y
 Z
 0
 1
 2
 3
 4
 5
 6
 7
 8
 9
 A
 B
 C
 D
 E
 F
 G
 H
 I
 J
 K
 L
 M
 N
 O
 P
 Q
 R
 S
 T
 U
 V
 W
 X
 Y
 Z
 0
 1
 2
 3
 4
 5
 6
 7
 8
 9
 A
 B
 C
 D
 E
 F
 G
 H
 I
 J
 K
 L
 M
 N
 O
 P
 Q
 R
 S
 T
 U
 V
 W
 X
 Y
 Z
 0
 1
 2
 3
 4
 5
 6
 7
 8
 9
 A
 B
 C
 D
 E
 F
 G
 H
 I
 J
 K
 L
 M
 N
 O
 P
 Q
 R
 S
 T
 U
 V
 W
 X
 Y
 Z
 0
 1
 2
 3
 4
 5
 6
 7
 8
 9
 A
 B
 C
 D
 E
 F
 G
 H
 I
 J
 K
 L
 M
 N
 O
 P
 Q
 R
 S
 T
 U
 V
 W
 X
 Y
 Z
 0
 1
 2
 3
 4
 5
 6
 7
 8
 9
 A
 B
 C
 D
 E
 F
 G
 H
 I
 J
 K
 L
 M
 N
 O
 P
 Q
 R
 S
 T
 U
 V
 W
 X
 Y
 Z
 0
 1
 2
 3
 4
 5
 6
 7
 8
 9
 A
 B
 C
 D
 E
 F
 G
 H
 I
 J
 K
 L
 M
 N
 O
 P
 Q
 R
 S
 T
 U
 V
 W
 X
 Y
 Z
 0
 1
 2
 3
 4
 5
 6
 7
 8
 9
 A
 B
 C
 D
 E
 F
 G
 H
 I
 J
 K
 L
 M
 N
 O
 P
 Q
 R
 S
 T
 U
 V
 W
 X
 Y
 Z
 0
 1
 2
 3
 4
 5
 6
 7
 8
 9
 A
 B
 C
 D
 E
 F
 G
 H
 I
 J
 K
 L
 M
 N

REPLAY OPERATIONS: neGcon™

UP/DOWN Directional buttons CHANGE CAR BEING TRACKED

B button ALTER VIEWPOINT

I button ALTER VIEWPOINT

A button ALTER VIEWPOINT

II button ALTER VIEWPOINT

START button END REPLAY

THE QUICK ARCADE MODE:

THE FLOW OF GAMEPLAY

To get you started, there now follows a step-by-step guide to playing a variety of races in GRAN TURISMO™. We'll start with the QUICK ARCADE mode. Select QUICK ARCADE from the Main Menu:

SELECT YOUR RACE MODE

On the QUICK ARCADE menu, you can choose from three different racing modes plus three other sub-menus. Use the UP/DOWN Directional buttons to highlight an option and the X button to select it.

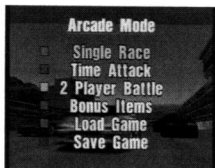

SINGLE RACE

TIME TRIAL

2 PLAYER BATTLE

BONUS ITEMS

LOAD GAME

SAVE GAME

Here, the SINGLE RACE mode is used as an example to explain the flow of gameplay in the QUICK ARCADE mode. For more information, see the individual sections on each option later on in this manual.

Arcade Mode

EASY
NORMAL
DIFFICULT

SELECT YOUR DIFFICULTY LEVEL

Select the level of difficulty for the race – choose between EASY, NORMAL and DIFFICULT. When playing for the first time, try the EASY beginner's level. Now you need to select the car you want.

Manufacturer

HONDA
MAZDA
MITSUBISHI
ASTON MARTIN
CHEVROLET
DODGE
Ford
General Motors

CHOOSE A CAR DEALERSHIP (MANUFACTURER)

Use the UP/DOWN Directional buttons to highlight a dealership and press the X button to choose the one you want.

CHOOSE YOUR CAR MODEL

Horsepower
Drive system
Class

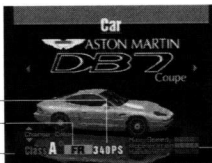

Performance graph:
(MAX SPEED
ACCELERATION
HANDLING)

Once you select the car to you wish to drive, cars of similar rank are automatically selected as the rival cars that you will race against. The performance graph uses a five-level rating system to rate three aspects of car performance: Max Speed, Acceleration, and Handling.

SELECT THE DRIVING STYLE

Select the driving style for your car. When racing to achieve the fastest time possible, select STANDARD. For flashier driving, select DRIFT. Press the X button to make your selection:

STANDARD	Racing-oriented settings.
DRIFT	Drift-orientated settings

SELECT THE GEAR TYPE

Here, indicate the type of transmission you want:

AT	Automatic transmission
MT	Manual transmission

COURSE SELECTION

Use the LEFT/RIGHT Directional buttons to select the course you wish to race on and press the X button to confirm the selection:

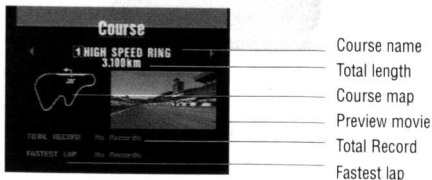

You're now ready to race!

RACING

This is a two-lap race against five rival cars. You automatically start this race in the last position each time and the race ends as soon as two laps are completed.

RACE OVER - VIEWING RESULTS

When your car crosses the finish line, the race results appear.

Rank	Car Model	Time
1	SUPRA RZ	1:53:154
2	IMPREZA STi TypeR	+0:081"
3	FORX7 Aspec	+0:213"
4	NSX 90	+0:221"
5	R33GT-R	+0:381"
6	GTO twinturbo	+0:783"

note: rank refers to your car's placing (1-6)

- Winning time
- Difference from winning time
- Car model
- Rank

REPLAY

The most recent race is replayed. The replay can be stopped by pressing the START button.

SETTING A NEW RECORD

When the record time or the best lap time is broken, then the NEW RECORD screen appears.

Category	Value	Note
Ranking	1st	
Total Time	1:53:154	New Record!
Lap Time		
Lap 1	1:00:436	
Lap 2	0:52:718	New Record!

- NEW RECORD indicates this record-breaking time.
- Total time
- Individual lap times

0
1
2
3
4
5
6
7
8
9
A
B
C
D
E
F
G
H
I
J
K
L
M
N
O
P
Q
R
S
T
U
V
W
X
Y
Z

ENTER YOUR NAME

Enter your name by moving the cursor to each letter or character one at a time. Select END to finish.

To check the record for each course, go to Course Selection .



AFTER THE RACE

POST RACE MENU

This menu appears after the end of each race. To return to the QUICK ARCADE menu, select the Exit icon.



REPLAY	The most recent race is replayed.
TRY AGAIN	Run the same race again under the same settings and conditions.
STARTING LINE-UP	Shows all cars running in the current race.
SAVE REPLAY	Saves the replay data for the current race.
Exit icon	Return to the QUICK ARCADE menu

MODES AND MENUS

TIME TRIAL

In the TIME TRIAL mode, your car races around the course alone, the objective being to achieve the fastest lap time possible. As in the SINGLE RACE mode, begin by selecting your car and course. When the pre-race menu appears, select START to begin the race.

START	Start TIME TRIAL race
LOAD GHOST REPLAY	Loads ghost data
Exit icon	Returns you to the QUICK ARCADE menu

GHOST CARS

A ghost car is a rival car that is transferred onto the course from replay data. When replay data is loaded to generate ghost cars, they will race against you in the TIME TRIAL mode as solid incorporeal rival cars that pass through you car without impacting against it.

Only replay data from a race run in the TIME TRIAL mode and on the same course as the one you have selected can be used to generate ghosts.

In TIME TRIAL mode, if you press the START button, the game will pause and bring up the Pause menu, where you will be able to select the GHOST CAR ON/OFF option. During a race, peripherals which have a SELECT button can use it to toggle the Ghost car on and off – peripherals without a SELECT button e.g neGcon should use the Pause Menu to switch the Ghost car on and off.

b
e
a
t
e
n
f
o
2
n
i
t
a
g

2 PLAYER BATTLE

In this mode, two players race against each other, each using a separate Controller. Players select their respective cars on a split screen that is divided horizontally. After each selection is entered, Player 1 selects the course and the race begins.

RACE SCREEN

The race takes place on a horizontally split screen. Each player can change the view independently of the other player, but the rear-view mirror does not appear in either view.

Player 1

Player 2

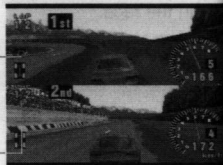

BONUS ITEMS

This lets you check on how much of each course you have cleared in the SINGLE RACE mode.

When you come in 1st place in a race, a colour-coded mark appears above the rank of the car used to indicate the level of difficulty. Select CANCEL to return to the QUICK ARCADE menu.

Level of difficulty

Rank of car used

Course

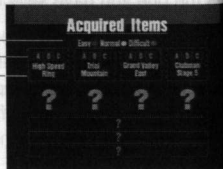

As each course is cleared under the various conditions, the areas under the question marks (?) are revealed one by one.

LOAD GAME/SAVE GAME

Caution: Do not remove the Memory card while an operation on this menu is in progress. Doing so may result in the loss of data on the Memory card or cause the game to malfunction. It is advised that you do not insert or remove Memory cards once the power is turned on. Make sure there are enough free blocks on your Memory card before commencing play.

It is possible to load and save game data. Note that loading or saving game data will change all OPTION settings, and all data in the QUICK ARCADE mode and the GRAN TURISMO mode to the settings that were originally saved onto the Memory card.

LOAD GAME/SAVE GAME: THE FLOW OF OPERATIONS

Select the Memory card slot you wish to access. The contents of the Memory card in that Memory card slot are displayed. To load data from or save data to this Memory card, select YES. To cancel without loading or saving data, press the Δ button.

Game data for the OPTION settings, QUICK ARCADE mode and GRAN TURISMO mode are all written to a single game data file occupying 5 Memory card blocks, and only one game data file can be stored on a single Memory card

THE GRAN TURISMO MODE

The GRAN TURISMO mode allows you to experience the realism and thrill of authentic auto racing. Savour the joy of winning a race in a car customised by you to your own specifications.

STARTING THE GAME

From the Main Menu, select GRAN TURISMO to bring up the map screen. Scattered across the map, surrounding the player's HOME, are dealerships, each carrying a list of models for that individual car manufacturer. Click the appropriate icon and step into the world of GRAN TURISMO.

RESUMING PLAY

If you have stored data from a previous GRAN TURISMO mode race onto a Memory card, you can resume play where you left off. Simply use the Directional buttons to highlight HOME on the map screen and press the X button to enter, then select the LOAD&SAVE icon from the next menu. Pick LOAD, then use the LEFT or RIGHT Directional buttons to highlight the Memory card you wish to load from (MEMORY CARD 1 or MEMORY CARD 2).

MAP MENU

The Map Menu lets you move to any of the various menus shown just by using the Directional buttons to highlight the icon for that menu and pressing the X button to select.

The category of each menu is indicated by its icon. Select the Exit icon (the picture of a door) to return to the Main Menu.



CREDITS: You begin a new game with 10,000 credits (Cr). Start out by looking for a used car that you can afford with this number of credits. After each race, drivers are awarded prize money commensurate with their performance. This prize money can be saved up to buy parts and other cars.

NUMBER OF DAYS ELAPSED: One day elapses each time you take a license test or run in a race (A qualifying race and the subsequent final race are together counted as one day).

GRAN TURISMO: THE FLOW OF GAMEPLAY

For features not described in this section, see the MENUS: A QUICK SUMMARY section later on in this manual.

In the GRAN TURISMO mode, the objective is to collect prize money by winning races and then use that prize money to upgrade to better, faster cars in order to win the more advanced races.

Here, a tutorial describes the flow of gameplay in the GRAN TURISMO mode.

i) PURCHASING A CAR

You must purchase a car in order to race. Because of the low number of credits you start with, begin by looking at a USED CAR. Of course, once your financial standing improves, you can start buying new cars.

GETTING A LICENSE

A racing license is needed to enter most races. Upon taking and passing the predetermined test, you will be presented with a license. See below for more details.

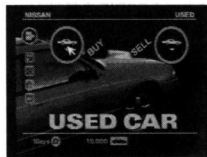

0 1 2 3 4 5 6 7 8 9 10 11 12 13 14 15 16 17 18 19 20 21 22 23 24 25 26 27 28 29 30 31 32 33 34 35 36 37 38 39 40 41 42 43 44 45 46 47 48 49 50 51 52 53 54 55 56 57 58 59 60 61 62 63 64 65 66 67 68 69 70 71 72 73 74 75 76 77 78 79 80 81 82 83 84 85 86 87 88 89 90 91 92 93 94 95 96 97 98 99 100

iii) RACING

The races are divided into different skill levels and different types of cars. The more difficult the race, the higher the prize money, so the objective is keep moving up to harder and harder races.



i) BUYING A CAR

You'll have to buy a car in order to race. Use the Directional buttons to move the cursor to the dealership you want. For this tutorial we'll choose NISSAN.



DEALERSHIP'S MENU

Because of the small number of credits you start out with, you will only be able to afford a used car.

CHOOSE USED CAR

CREDITS

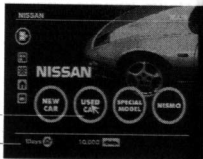

SELECTING A CAR TO BUY

On the USED CAR screen, you can also sell your car. Since you need to buy a car at this point, select BUY.

After you select BUY, a list of all currently available car models appears. To select the car you want to buy, move the cursor up or down to highlight that car. To see how it's

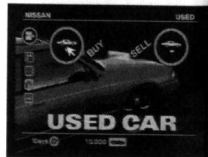

done, let's buy the '88 Silvia (S13 Silvia '88 Q's 1800 cc).

Align the cursor and press the X button. As the inventory of used cars changes regularly, it's a good idea to check back here frequently.

Next, the car you have selected appears. Examine the SPEC and INFO screens and decide whether or not you want to purchase the car. To buy the car, highlight the BUY icon and press the X button.

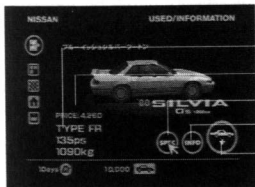

- Drive system/Horsepower/Car weight
- PRICE:
- SPEC: Shows the car's performance specifications
- INFO: Gives detailed information about the car
- Select BUY.

NOTE: Car colour cannot be changed when buying a used car.

ii) TAKING YOUR LICENSE

After purchasing a car, the next step is to obtain a racing license. All licenses are obtained on the LICENSE menu, reached via the Map menu. This is an overview of the general flow of operations for taking your license test, but for a more detailed explanation, please consult the LICENSE section in MENUS: A QUICK SUMMARY later on in this manual.

The three classes of licenses are CLASS B, CLASS A and CLASS A INTERNATIONAL, which must be obtained in this order. When obtaining a license for the first time, you must take the Class B license test.

0 1 2 3 4 5 6 7 8 9 A B C D E F G H I J K L M N O P Q R S T U V W X Y Z

TAKING A LICENSE TEST

A license test comprises 7 preliminary tests and 1 final test. Unless you take and pass the 7 preliminary tests (starting at the top of the Test List), you cannot take the final test, which is at the bottom of the Test List. When you select a test, a description of the test appears. The first test you can take is **STARTING AND STOPPING 1**.

ABOUT THE TEST DESCRIPTIONS

This screen gives the test instructions and the requirements for passing. Read the text carefully before taking the test. Once you select the type of transmission you want (AT or MT), the test begins. Press the X button to enter your selection.

- The preliminary tests do not have to be taken in the order in which they appear on the Test List, but taking them in this order will enable you to refine your driving skills.
- When taking a license test, you will use a car prepared especially for testing purposes.
- After taking the test, a cup commensurate with your test performance will appear in the column of tests from the Test List that you have passed.

Viewing the Test Results after passing a test

The results screen appears once the test is completed. There are three levels of passing performance. In ascending order, they are: **BRONZE**, **SILVER** and **GOLD**. In other words, **GOLD** is awarded to drivers who demonstrate the best possible performance on the test. To return to the post-test menu, press any button.

Viewing the Test Results after failing or retiring

After failing or retiring, press any button to proceed to the post-test menu, just as you would do after passing the test.

After Completing the License Test

To immediately take another test, bring up the screen for whichever license you wish to take and select TRY SESSION. Select Try Session # to take you to the next test.

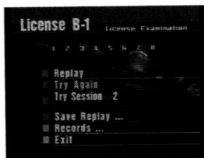

REPLAY:	Replays the most recent test
TRY AGAIN:	To retake the most recent test
TRY SESSION:	To take the next test. Use the LEFT/RIGHT Directional buttons if you wish to change the test you want to take
SAVE REPLAY:	Saves the replay of the most recent test
RECORDS:	Displays the record times for each test
EXIT icon:	To return to the LICENSE menu

- You can also retake a license that you have already passed.
- Even if you fail a preliminary test, you can still take the next preliminary test (though you cannot take the final test until you've passed all the others).
- Selecting the Exit icon does not delete the pass status information.

TAKING A LICENSE TEST

A license test comprises 7 preliminary tests and 1 final test. Unless you take and pass the 7 preliminary tests (starting at the top of the Test List), you cannot take the final test, which is at the bottom of the Test List. When you select a test, a description of the test appears. The first test you can take is **STARTING AND STOPPING 1**.

ABOUT THE TEST DESCRIPTIONS

This screen gives the test instructions and the requirements for passing. Read the text carefully before taking the test. Once you select the type of transmission you want (AT or MT), the test begins. Press the X button to enter your selection.

- The preliminary tests do not have to be taken in the order in which they appear on the Test List, but taking them in this order will enable you to refine your driving skills.
- When taking a license test, you will use a car prepared especially for testing purposes.
- After taking the test, a cup commensurate with your test performance will appear in the column of tests from the Test List that you have passed.

Viewing the Test Results after passing a test

The results screen appears once the test is completed. There are three levels of passing performance. In ascending order, they are: **BRONZE**, **SILVER** and **GOLD**. In other words, **GOLD** is awarded to drivers who demonstrate the best possible performance on the test. To return to the post-test menu, press any button.

Viewing the Test Results after failing or retiring

After failing or retiring, press any button to proceed to the post-test menu, just as you would do after passing the test.

The sequence of each race is as follows.

QUALIFY/FREE SESSION

Here, you lap the course freely and alone. Once you learn the course, it's a good idea to adjust your car's settings.

FAST QUALIFY

In this qualifying run, you run the course alone to try for the best time possible, as in the TIME TRIAL mode. Since your starting position in the final race is determined by your qualifying time, stay calm, concentrate and try for the fastest time possible.

BEST RUN

This is the last test run of the course before the final race. Take advantage of this opportunity by reviewing any mistakes you made during the qualifying runs and by changing to final race settings, for instance.

START RACE

At last it's time for the finals. Here you compete for 1st place with 5 rival cars.

QUALIFYING

Select TEST RUN to begin your test run, or Start Qualify to begin the qualifying run. To skip the qualifying process, select EXIT and then SKIP QUALIFY. When you skip the qualifying process, you start the finals in the last position.

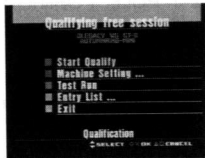

Select Start Qualify

Your starting position in the finals is determined by your lap time in this 1-lap qualifying run. The faster your lap time, the closer to the front your starting position is. Qualifying ends as soon as one lap of the course is completed.

END OF QUALIFYING

During the test run, you can lap the course as many times as you wish until you decide to retire or go on to the qualifying runs.

VIEWING QUALIFYING RESULTS

This screen shows the qualifying results. Select NEXT to view a stats screen and from there onto the POLE POSITION BONUS screen.

Position	Car model	Time
1	MIRAGE CyberGR	0:41.943
2	KEVIN RZC	+0.348
3	CIVIC FERIO-93 SR	+0.589
4	DEMIO GLX	+1.179
5	STASILVIA Q's	+1.332
6	LEGACY WR GT-B	+15.220

Winning time
 Difference from winning time
 REPLAY
 Replays the most recent race
 Select NEXT

POLE POSITION BONUS

If you come in 1st place in the qualifying run, you receive a sum of prize money called the POLE POSITION BONUS. Press any button to begin the RACE/FREE SESSION phase.

RACING: THE FINALS

Select Test Run to begin your test run, or Start Race to begin the finals.

This is a race against 5 rival cars. The finals end when the predetermined number of laps is completed.

FINALS COMPLETED

During the test run, you can lap the course as many times as you wish until you decide to retire or go on to the qualifying runs.



VIEWING THE FINAL RESULTS

FINAL RANKING

This shows the ranking in the finals. After the final ranking is displayed, the next screen appears automatically.

Winning time	0:41:843
Difference from winning time	+0:346"
Car model	MIRAGE CyborgR
Position	1

	+0:699"
	+1:179"
	+1:332"
	+15:227"



AUTOMATIC

These are the points awarded to each driver according to position in the finals. The points awarded are, in descending order beginning with 1st place: 9, 6, 4, 3, 2, 1

The next screen appears automatically.

TOTAL POINTS

This is the point ranking, where cars are ranked by the total number of points they have accumulated in all races held up to that point. To see the prize money totals, select NEXT

PRIZE MONEY WON

Each driver is awarded an amount of prize money commensurate to their position in the final ranking.

Press any button to proceed to the next race.

0 1 2 3 4 5 6 7 8 9 A B C D E F G H I J K L M N O P Q R S T U V W X Y Z

v) **GO RACE**

Select this menu to enter any of the various types of races, including 2-player races.



vi) **MACHINE TEST**

Race a test course to check your car's performance and determine its limits.



vii) **CAR WASH**

When your car gets dirty from racing, click here to wash it and get it clean for the next race.

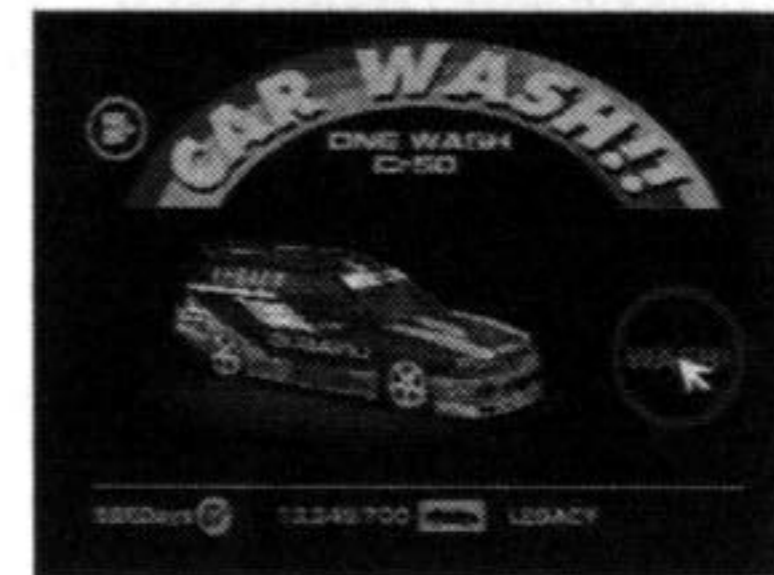

COMPOSITION OF MENU SCREENS

The example below shows the basic composition of menu screens.

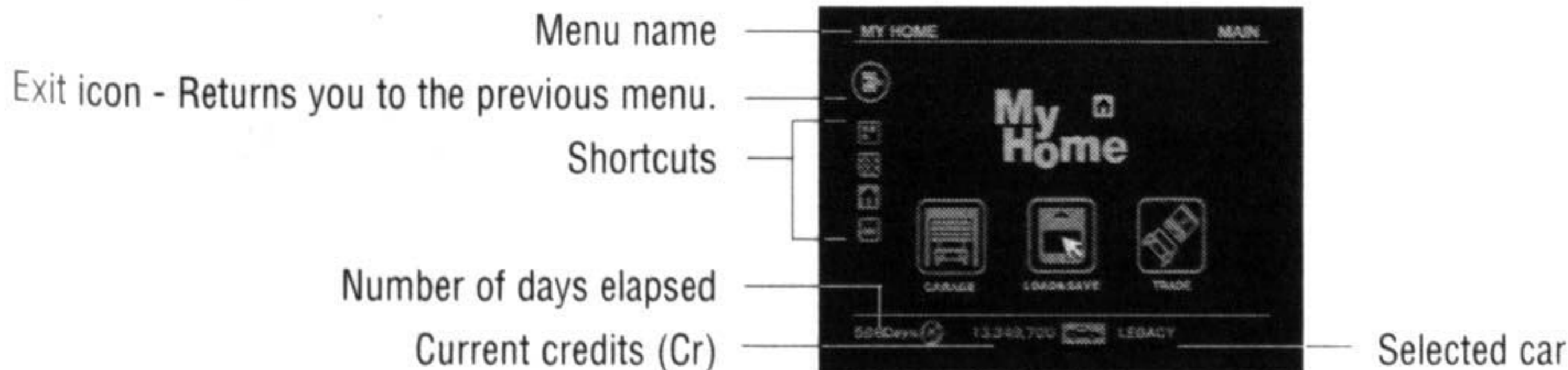

0 1 2 3 4 5 6 7 8 9 A B C D E F G H I J K L M N O P Q R S T U V W X Y Z

FOR JUMPING DIRECTLY TO ANOTHER SCREEN

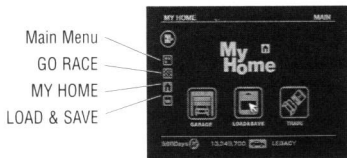

MY HOME MENU

From the Map menu, use the Directional buttons to highlight the HOME icon and press the X button to enter.

GARAGE LOAD&SAVE TRADE

i) GARAGE

This is where you compare the specifications of the cars in your possession in order to decide which one to use in the next race (see the GARAGE section below)

ii) LOAD&SAVE

For loading and saving game data (see LOAD GAME/SAVE GAME earlier in this manual)

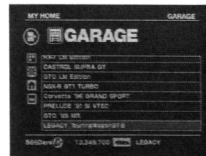

iii) TRADE

This feature allows a car saved on a Memory card in Memory card slot 2 to be transferred to your Garage during the current game. Use the UP/DOWN Directional buttons to highlight the car you wish to trade. You'll be asked to confirm that you wish to transfer the car you've selected by selecting YES. NOTE: You can only trade a car if you possess enough money for the car you've selected. For more information, see the TRADE section below.

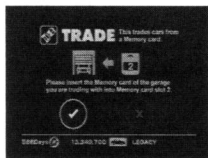

GARAGE

Here you'll find a list of all the cars you currently own. To check out the specifications of one of your cars, move the cursor to that car and select it to bring up the Information screen.

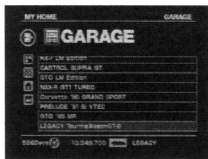

Select SPEC or INFO to see detailed information about your car, or select Change Cars to make this the car to use in the next race.

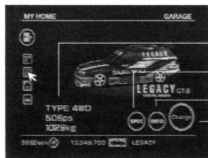

- Drive system/Horsepower/Car weight
- SPEC
- INFO
- Change Cars

NOTE: When you select Change Cars, that car becomes your selected car.

0 1 2 3 4 5 6 7 8 9 A B C D E F G H I J K L M N O P Q R S T U V W X Y Z

MY HOME MENU

LOAD & SAVE

See the section LOAD & SAVE in QUICK ARCADE.

TRADE

Caution: Do not remove the Memory card while an operation on this menu is in progress. Doing so may result in the loss of data on the Memory card or cause the game to malfunction. It is advised that you do not insert or remove Memory cards once the power is turned on. Make sure there are enough free blocks on your Memory card before commencing play.

With this feature, you can transfer to your GARAGE a car from GRAN TURISMO mode data stored on a Memory card in Memory card slot 2. To complete a trade, you have to pay a registration fee as well as the total cost of all parts installed in the car. The cars and credits in the game data in Memory card slot 2 remain the same after trading. In other words, the traded car is not deleted and the credits you pay are not transferred to the GARAGE.

First, ensure the Memory card containing the data with the car in the Garage is inserted into Memory card slot 2.

The contents of the Garage data stored on the Memory card appear on the screen. Select the car you wish to trade by moving the red cursor up or down to that car.

NOTE: Any parts installed prior to when the data was saved are also added to the Garage along with the car.

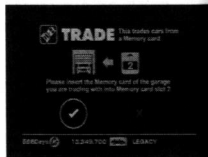

CAR DEALERSHIP MENU

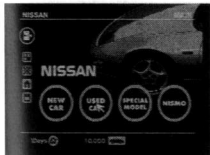

- NEW CAR** Purchase a new car here.
- USED CAR** For buying and selling used cars.
- SPECIAL MODEL** This is where authentic racing cars can be purchased.
- TUNE-UP SHOP*** This is a parts and tune-up shop where you can purchase various types of auto parts.

* The items that are available on this menu vary depending on the dealership.

NEW CAR

When you select the car that you want from the new car list, the INFORMATION screen for that car appears. To view other pages, select BACK or NEXT.

Select SPEC or INFO to see detailed information about the car. If you want to buy the car, select BUY.



- BUY
- INFO
- SPEC

Drive system/Horsepower/Car weight

USED CAR

If you select BUY, a list of all models currently available for purchase is shown. Move the cursor up or down the list to the car you wish to buy, then select it by pressing the X button to bring up the screen for that car. To help you decide whether or not to buy the car, take a look at the SPEC and INFO screens. If you decide to buy the car, select the BUY icon and press the X button.

- INFO
- BUY
- SPEC
- PRICE

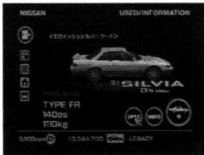

0 1 2 3 4 5 6 7 8 9 10 11 12 13 14 15 16 17 18 19 20 21 22 23 24 25 26 27 28 29 30 31 32 33 34 35 36 37 38 39 40 41 42 43 44 45 46 47 48 49 50 51 52 53 54 55 56 57 58 59 60 61 62 63 64 65 66 67 68 69 70 71 72 73 74 75 76 77 78 79 80 81 82 83 84 85 86 87 88 89 90 91 92 93 94 95 96 97 98 99 00

SELL

If you wish, you can sell the currently selected car. The purchase price appears on this screen. If the price is acceptable to you, select the SELL icon and press the X button to sell the car.

Purchase price (in credits)

SELL

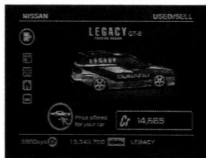

NOTES: As the inventory of used cars changes regularly, it's a good idea to check back here frequently. Car colour cannot be changed when buying a used car. Any dealer's car can be sold here.

SPECIAL MODEL

This is where you can purchase specially tuned, authentic racing cars. The prices may be exorbitant, but these advanced machines far outperform the mass-production models. Select SPEC to see detailed information about a special model. If you wish to buy the car, select the BUY icon and press the X button.

Price (in credits)

Change Car Colour

Drive system/Horsepower/Car weight

BUY

SPEC

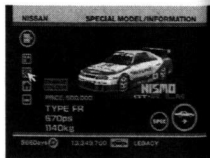

NOTE: Some Car Manufacturers do not offer special models.

TUNE-UP SHOP

i) **PARTS:** You can install parts to enhance your car's performance. Fine-tune your auto parts on the Machine Setting menu.

ii) **BUY PARTS:** As the type of part you will need depends on the car's model, parts for the currently selected car model must be purchased from the manufacturer of the currently selected car.

iii) **SETTINGS/REPLACE PARTS:** Adjust the settings as you drive the course to determine which settings (and which parts) are best suited to your driving style and to the conditions of the race.

The Tune-up Shop offers a variety of tune-up parts.

To purchase parts, first select the category of parts and then the specific part that you want.

On the BUY screen, refer to the description of each part to determine which type of part you need.

To purchase the part, select BUY.

Description of part
 Part price (in credits)
 BUY

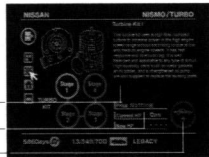

NOTES: Some manufacturers do not have a Tune-up Shop. The actual name of each Tune-up Shop varies from dealer to dealer. For information about each part, refer to the 'GT Racing Strategy Guide' later on in this book.

LICENSE MENU

The three classes of licenses are Class B, Class A and Class A International, which must be obtained in that order. When obtaining a license for the first time, you must take the Class B license test.

Class B License
 Class A License
 Class A International License

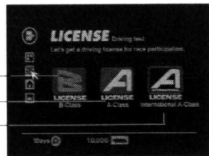

G
 1
 2
 3
 4
 5
 6
 7
 8
 9
 10
 11
 12
 13
 14
 15
 16
 17
 18
 19
 20
 21
 22
 23
 24
 25
 26
 27
 28
 29
 30
 31
 32
 33
 34
 35
 36
 37
 38
 39
 40
 41
 42
 43
 44
 45
 46
 47
 48
 49
 50

CLASS B LICENSE

STARTING AND STOPPING 1

STARTING AND STOPPING 2

BASICS OF CORNERING 1

BASICS OF CORNERING 2

BASICS OF CORNERING 3

BASICS OF MULTIPLE CORNERS 1

BASICS OF MULTIPLE CORNERS 2

TEST FOR A B-CLASS LICENCE

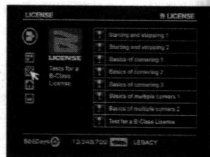

A license test comprises 7 preliminary tests and 1 final test. Unless you take and pass the 7 preliminary tests (starting at the top of the Test List), you cannot take the final test, which is at the bottom of the Test List.

The Class B License requires mastery of basic automobile operation.

- The preliminary tests do not have to be taken in the order in which they appear on the Test List, but taking them in this order will enable you to refine your driving skills.
- After taking the test, a cup commensurate with your performance on the test will appear in the column of tests from the Test List that you have passed.

CLASS A LICENSE

PRACTICAL CORNERING 1

PRACTICAL CORNERING 2

PRACTICAL CORNERING 3

COPING WITH MULTIPLE CORNERS 1

COPING WITH MULTIPLE CORNERS 2

COPING WITH MULTIPLE CORNERS 3

SPECIAL TECHNIQUES

TEST FOR AN A-CLASS LICENSE



Passing the Class A License test requires a command of more advanced auto racing techniques. Obtaining a Class A License will allow you to enter a far broader range of races.

CLASS A INTERNATIONAL LICENSE

HIGH-SPEED RING ? TIME ATTACK

SS ROUTE 5 ? TIME ATTACK

GRAND VALLEY ? TIME ATTACK

DEEFOREST ? TIME ATTACK

AUTUMNRING ? TIME ATTACK

TRIAL MOUNTAIN ? TIME ATTACK

SS ROUTE 11 ? TIME ATTACK

INTERNATIONAL ? TEST: A-CLASS LICENSE



The test for a Class A International License takes place entirely in the TIME TRIAL mode. This license requires competitive-level speed. Obtaining a Class A International License allows you to enter any race.

0 1 2 3 4 5 6 7 8 9 10 11 12 13 14 15 16 17 18 19 20 21 22 23 24 25 26 27 28 29 30 31 32 33 34 35 36 37 38 39 40 41 42 43 44 45 46 47 48 49 50 51 52 53 54 55 56 57 58 59 60 61 62 63 64 65 66 67 68 69 70 71 72 73 74 75 76 77 78 79 80 81 82 83 84 85 86 87 88 89 90 91 92 93 94 95 96 97 98 99 100

GO RACE MENU

- GT LEAGUE:** Race in Official League competitions
- SPECIAL EVENT:** Unique racing events
- SPOT RACE:** Single-race competitions for beginners
- TIME TRIAL:** Your car runs the course alone to try
 for the fastest time possible
- MEMORY CARD BATTLE:** Hold 2-player races using game data
 on a Memory card



GT LEAGUE

- SUNDAY CUP
- CLUBMAN CUP
- GT CUP
- GT WORLD CUP
- License required



This is the official GRAN TURISMO championship. The objective here is to become League champion. As in other auto racing leagues, victory in a GT League competition is determined by total ranking points earned in 3 to 6 races. The four cup races held are, in order of difficulty and importance: SUNDAY, CLUBMAN, GT and GT WORLD.

For detailed information about each league competition, refer to the 'GT Racing Strategy Guide' later on in this book.

SPECIAL EVENT

There are 13 different special racing events, including gruelling endurance races and unique regulation races such as races limited by car type/drive train type and

mega-speed races with super-fast high-spec machines. To move back to the previous screen or forward to the next screen, select BACK or NEXT from the onscreen menu. For detailed information about each event, refer to the 'GT Racing Strategy Guide' later on in this book.

SPOT RACE / TIME TRIAL

SPOT RACE: Single races for beginners. Select the course you want to run. No license is required.

TIME TRIAL: Here, your car runs the course alone, and the objective is to achieve the fastest time possible. Begin by selecting the course you wish to run. It's a good idea to practice here as a way of preparing for the GT LEAGUE and checking your settings. As in the SPOT RACE, no license is necessary.

MEMORY CARD BATTLE

Caution: Do not remove the Memory card while an operation on this menu is in progress. Doing so may result in the loss of data on the Memory card or cause the game to malfunction. It is advised that you do not insert or remove Memory cards once the power is turned on. Make sure there are enough free blocks on your Memory card before commencing play.

With two Controllers connected, you can have 2-player competitive races using game data stored on a Memory card. This requires two Memory cards each containing game data for at least one car.

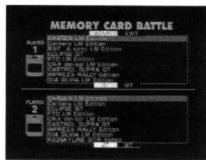

0 1 2 3 4 5 6 7 8 9 A B C D E F G H I J K L M N O P Q R S T U V W X Y Z

MEMORY CARD BATTLE: The Flow of Gameplay

First, insert the Memory cards containing the game data for Player 1 and Player 2 into Memory card slot 1 and Memory card slot 2, respectively. The GARAGE contents appear on the screen.

On the horizontally-split screen, each player selects the car he or she wants to use. Once each player has entered his or her decision, Player 1 must select START. Player 1 then selects the course and the race begins.

NOTE: The parts and settings used are those from the time that the data were saved.

The race takes place on a horizontally split screen. Each player can change the view independently of the other player, but please note that the rear-view mirror does not appear in either view.

MACHINE TEST MENU

This is for testing your car's performance, such as acceleration and top speed.

- 0-400 Clock your time on a 400-meter straightaway
- 0-1000 Clock your time on a 1,000-meter straightaway
- Top Speed Clock your top speed on an oval course

CAR WASH MENU

When your car gets dirty from racing, bring it here to get it clean. Select WASH! to give your car the complete valet service – one service costs 5,000 credits.

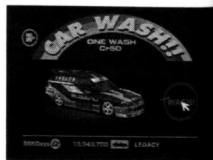

WASH!

NOTE: Whilst dirt does not affect a car's performance, it will be visible on your car in the replays if you do not enter it for a valet service.

PIT STOP

Entering the Pit Road during a race automatically initiates a PIT STOP. During a PIT STOP, your car's tires are replaced with new ones. The condition of your tyres is indicated on the Tyre Indicator.

TYRE

Tyres are replaced with new tyres of the same model that were on your car at the start of the race. During a test run, you can take a PIT STOP to the FREE SESSION menu from the Pause menu.

FREE SESSION MENU

The Free Session menu is where you can change your car's settings and take a test run.

START QUALIFY / START RACE Proceed to the qualifying

round or to the finals

CAR SETTING For changing your car's

settings or replacing parts

TEST RUN Begin the test run

ENTRY LIST / CHECK GRID Entries are shown in order of starting position (on the ENTRY LIST)

and in order of racing results (on the CHECK GRID)

Exit icon Stops the race



0 1 2 3 4 5 6 7 8 9 A B C D E F G H I J K L M N O P Q R S T U V W X Y Z

CAR SETTING MENU

On the Free Session menu, selecting Machine Setting brings up the Machine Setting screen.

This screen is for tuning and replacing parts and for loading and saving settings.

SETTINGS For changing the settings of parts

CHANGE PARTS For changing parts

SAVE SETTING Saves the current settings

LOAD SETTING Loads settings from a Memory card

RETURN Returns you to the FREE SESSION menu

- Only parts already installed on your car can be tuned.
- Setting data is saved separately from game data and takes up 2 Memory card blocks.

SETTING/CHANGE OPERATIONS

ANALOG CONTROLLER (DUAL SHOCK)

L1 button Takes you to the PARTS SETTING screen

R1 button Takes you to the CHANGE PARTS screen

O button Select / confirm

X button Select / confirm

△ button Cancel

□ button Cancel

Directional buttons Move cursor / alter settings

- Press the L1 button and R1 button along with the Directional buttons to change a setting's numerical value rapidly.
- Operations for the Controller (digital) is the same as the operations above.
- When using the neGcon™, the operations are as follows:

L button	Takes you to the PARTS SETTING screen
R button	Takes you to the CHANGE PARTS screen
A button	Select / confirm
I button	Select / confirm
B button	Cancel
II button	Cancel
Directional buttons	Move cursor / alter settings

SET UP SCREEN

This screen is used to tune your car's parts. Installed parts can be fine-tuned and settings are divided into 3 categories. First, select the category of the part you wish to tune, then press the RIGHT Directional button to select the setting parameter you wish to change.



SUSPENSION For adjusting the suspension, wheels and other related parts



ENGINE For adjusting the engine and related parts



AERO DYNAMICS For changing settings that affect the car's aerodynamic performance

SETTING PARAMETERS: SUSPENSION

SPRING RATIO

Adjustable parts: Racing support

Adjust the stiffness of the springs. The stiffer the springs are, the quicker the car's responsiveness will be, but excessive stiffness will result in an unstable vehicle attitude on uneven road surfaces.

RIDE HEIGHT

Adjustable parts: Semi-racing, racing support

Adjust the car's height. Lowering the car's height gives it a lower centre of gravity, for a stable ride. When doing so, also raise the spring ratio and damping ratio to prevent bottoming out due to stroke reduction.

DAMPER

Adjustable parts: Semi-racing, racing support

Adjust the damper's damping force (damping ratio). A too-soft damping force makes the car unstable, while a too-hard damping force makes for a bumpy ride at spots such as corner exits. It's important to match this setting to the spring ratio.

CAMBER

Adjustable parts: Semi-racing, racing support

Adjust the negative camber angle. A negative camber angle enhances stability during cornering in which the car rolls, but at the same time lowers braking power and steering response. Be sure not to make the negative camber angle too large.

STABILISERS

Adjustable parts: Stabilizers (all types)

Adjust the stabilisers' roll rigidity. Generally, greater rigidity increases stability during turning, although the ideal rigidity depends on the suspension settings. Proper adjustment of the front stabilisers' roll rigidity is especially important with front-engine, front-wheel-drive vehicles.

CHANGING PARTS

From among the parts you have purchased, you can select one to install in your car, or remove a part that is currently installed. Parts are divided into 4 general categories. First, select the category of the part you wish to change, then use the RIGHT Directional button to select the specific part.



SUSPENSION

Replace parts related to suspension and the tires



ENGINE

Replace engine parts



DRIVE TRAIN

Replace drive train parts



ASPIRATION

Replace intake and exhaust parts

EXCHANGING PARTS

Move the cursor up and down through the categories and select the parts you wish to change.

When you select a certain vehicle part, a list of available parts is displayed. Parts you have already bought are highlighted, so select the parts you wish to use. If you press the LEFT Directional button on the part type list, you will be returned to the category selection list.

REPLAY THEATRE

REPLAY FILES

The size of replay files is displayed in units called SECTORS. You can allocate 2 to 15 Memory card blocks depending on the amount of free blocks there are on your Memory card.

NOTE: Depending on the type of peripheral you are using, and the amount of laps selected, the number of sectors required for a save will vary.

SAVING REPLAY FILES

When there is no replay data saved to a Memory card, you can create replay data. You will need a Memory card with a minimum of 2 free Memory card blocks available. If the Memory card already contains replay data, you can overwrite it. If there is insufficient space on the Memory card, you should erase any unnecessary data on the Memory card using the L1 button and R1 button (pressing the L1 button and R1 button together deletes replay files) or use the PlayStation® Internal Memory card manager as outlined in its Instruction Manual.

NOTE: In 2-Player, and in 1-Player Endurance modes, depending on the peripherals used and the amount of laps chosen, some races may not be replayed in their entirety.

REPLAY THEATRE MENU

This menu is for managing replay files saved onto Memory cards. You can use it to replay a race, to change the title of a file, or to delete a file.



LOAD REPLAY	Load and play replay files
EDIT REPLAY TITLE	Change the title of a replay file
DELETE REPLAY	Delete a replay file
DEMONSTRATION	Play a pre-recorded replay file from the game Disc
Exit icon	Return to the Main Menu



LOAD REPLAY

With this menu you can load a file from a Memory card and replay it. Select the file you wish to replay. Selecting the Exit icon takes you back to the REPLAY THEATRE menu without replaying a file.

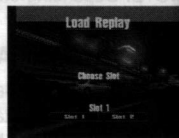

DEMONSTRATION

This menu replays a pre-recorded file from the game Disc. Just select the file you wish to replay. Selecting the Exit icon takes you back to the REPLAY THEATRE menu without replaying a file.



The GRAN TURISMO™ game Disc contains various replay files which can be used as a reference to improve your driving skills or watched like a movie simply for the fun of it.

EDIT REPLAY TITLE

Select the file that you wish to re-name. This takes you to the TITLE REGISTRATION screen. You should input the new file name and then select END. After checking the new title details are correct, select OK. The new file title will now be saved. Selecting the Exit icon takes you back to the REPLAY THEATRE menu without re-naming the file.

DELETE REPLAY

To delete a file, first select the file you wish to delete, then go to OK. Selecting the Exit icon takes you back to the REPLAY THEATRE menu without deleting a file. You can also select a number of files to delete together.

OPTION MENU

This menu controls the game and Controller settings across a number of different settings screens. Select a screen you want using the LEFT & RIGHT Directional buttons and confirm your selection by pressing the X button. To change options, use the UP & DOWN Directional buttons to highlight the option category you wish to change and the LEFT & RIGHT Directional buttons to alter each option. Once you have configured the options you want, press the X button again to confirm the selection. On the XA MUSIC TEST screen, use the Directional buttons to highlight a music track and press the X button to listen to it.

NOTE: The OPTION settings, QUICK ARCADE mode data and GRAN TURISMO mode data can be saved onto a Memory card. Only one save from each mode can be saved to each Memory card.

CONFIGURATION 1	This screen controls the settings for 2-player battles, back-ground music & sound
CONFIGURATION 2	This screen controls the settings for the race screens
BUTTON CONFIGURATION	This screen allows you to alter the Controller configurations during the game
ANALOG SETTING 1P & 2P	On these screens you can adjust the neGcon™ settings
XA MUSIC TEST	Listen to the different music samples from the game

CONFIGURATION 1

This screen controls the settings for 2-player battles, Background music & sound as well as allowing you to switch the vibration function of your Analog Controller (Dual Shock) on and off. These settings are effective for both the QUICK ARCADE mode and the GRAN TURISMO mode.

2-PLAYER BATTLE

LAPS: Sets the number of laps for 2 Player BATTLES. Choose from 1 lap to 30 laps or select FREE.

TYRE DAMAGE: Sets the speed of wear on the tyres: NONE, SLOW or FAST.

HANDICAP: This function allows you to set a handicap to increase the speed of the car of the player who is losing: NONE, LOW or HIGH. NONE offers the greater challenge to the losing player, HIGH offers a greater challenge to the winning player.

SOUND

MUSIC: Turns the background music volume up or down.

SE: Turns the sound effects volume up or down.

DUAL SHOCK

VIBRATION: Turns the Analog Controller (Dual Shock) vibration function ON or OFF.

CONFIGURATION 2

This screen controls the settings for the race screens in both the QUICK ARCADE and the GRAN TURISMO modes.

VIEW STATUS

VIEW POSITION: This sets the viewpoint at the start of the race: DRIVER places the camera inside the car, and CHASE has the camera following the race from behind your vehicle.

CHASE VIEW: Set the camera angle for when you are chasing other cars. Choose from LOOSE (lower than normal), NORMAL and TIGHT (higher than normal).

COURSE MAP: You can choose whether or not to have a map of the course displayed on the screen during the race. Choose between ON or OFF.

VIEW VOLUME: This sets the width of your view. Choose between NARROW, NORMAL and WIDE. The wider the view, the faster you feel you are driving.

BUTTON CONFIGURATION

This screen alters the Controller configuration settings during the game. Select the item you wish to change using the UP & DOWN Directional buttons and press the button you would like to set for that function. If you are using an Analog Controller (Dual Shock), set the Analog mode switch ON (LED indicator lights up RED). You can now change the settings of the items marked with arrow marks on the screen using the LEFT & RIGHT Directional buttons.

Keep the START button pressed and move the Directional buttons to set the button operations. Selecting DEFAULT returns you to the normal button settings, whilst selecting the Exit icon finishes button configuration selection.

STEERING	Steering wheel operation
ACCELERATION	Accelerator
BRAKE	Brake
REVERSE	Reverse

EMERGENCY BRAKE	Hand-brake
-----------------	------------

SHIFT UP	Shift up
----------	----------

SHIFT DOWN	Shift down
------------	------------

REAR VIEW	Rear-view mirror
-----------	------------------

CHANGE VIEW	Change view
-------------	-------------

Please refer to OPERATION DURING THE RACE for details of the normal operation settings.

ANALOG SETTING

In this screen you can adjust the neGcon™ settings, including the operation of the steering, the accelerator and the brake in-game. Please note: This is an option for the analog capabilities of the neGcon™ and NOT the Analog Controller (Dual Shock). Should you wish to adjust your Analog Controller (Dual Shock) settings you may do so through the BUTTON CONFIGURATION option.

Select the item you want to adjust using the UP and DOWN Directional buttons and change the settings using the LEFT and RIGHT Directional buttons. Pressing the R button allows you to set the sensitivity for the item selected.

STEERING

CENTRE	Set the centre position of the steering wheel.
--------	--

MARGIN	Set the amount of play for the steering wheel
--------	---

MAX	Set the maximum position of the steering wheel
-----	--

ACCELERATION

MARGIN Set the amount of play for the accelerator

MAX Set the maximum position of the accelerator

BRAKE

MARGIN Set the amount of play for the brake

MAX Set the maximum position of the brake

C
E
T
T
i
u
q
S
t
s
t
M
t
o
b
e